

**Fall 2004 Avian Migration Surveys at the Proposed Deerfield Wind/Searsburg  
Expansion Project in Searsburg and Readsboro, Vermont**

**Prepared For:**

Deerfield Wind, LLC  
&  
Vermont Environmental Research Associates

**Prepared By:**

Robert D. Roy  
Steven K. Pelletier

Woodlot Alternatives, Inc.  
30 Park Drive  
Topsham, ME 04086

April 2005

## Table of Contents

<b>1.0</b>	<b>INTRODUCTION.....</b>	<b>1</b>
1.1	Project Description.....	1
1.2	Project Area Description.....	1
1.3	Survey Overview .....	2
<b>2.0</b>	<b>METHODS .....</b>	<b>5</b>
2.1	Diurnal Raptor Surveys.....	5
2.2	Nocturnal Radar Surveys .....	8
<b>3.0</b>	<b>RESULTS .....</b>	<b>13</b>
3.1	Diurnal Raptor Surveys.....	13
3.2	Radar Survey Results .....	19
<b>4.0</b>	<b>DISCUSSION .....</b>	<b>24</b>
4.1	Diurnal Raptor Surveys.....	24
4.2	Radar Surveys .....	26
<b>5.0</b>	<b>CONCLUSIONS .....</b>	<b>30</b>
<b>6.0</b>	<b>LITERATURE CITED .....</b>	<b>31</b>

## List of Appendices

- Appendix A Raptor Survey Data Tables
- Appendix B Radar Survey Data Tables
- Appendix C Nightly Mean Flight Direction Histograms

## **1.0 Introduction**

### **1.1 Project Description**

Deerfield Wind, LLC has proposed to develop the Deerfield Wind/Searsburg Expansion Project, a wind power facility located on Federal land in the Towns of Searsburg and Readsboro, Vermont, (Figure 1) now known as the Deerfield Wind Project. The project would be constructed on approximately 80 acres of land in the Manchester District of the Green Mountain National Forest, adjacent to Green Mountain Power Corporation's (GMP) existing Searsburg Wind Facility, constructed in the mid 1990's. The expansion project will occur in two areas. The Eastern Expansion Area is located east of State Route 8, immediately south of the existing 11-turbine, 6 megawatt (MW) facility, and the Western Expansion Area is located on the west side of Route 8. The proposed expansion project consists of adding 20 to 30 wind turbines, capable of producing approximately 30 to 40 MW (megawatts). A unique feature of this proposal is that it will rely, in part, on the existing Searsburg facilities and infrastructure, including the substation and access road.

### **1.2 Project Area Description**

The project area is located in Searsburg and Readsboro, Vermont, approximately 15 miles north of the Massachusetts border. It is in the Southern Green Mountains Biophysical Region of Vermont. This region is an area of varied topography, with high peaks, plateaus, steep sided valleys, and foothills. Mountaintops in this region are somewhat randomly located, in sharp contrast to the long, linear arrangements of the highlands of northern Vermont. The mountaintops are characterized by thin soils and abundant, exposed, acidic bedrock but the lower slopes and valleys in this region contain deep glacial till soils.

The climate of the region is generally cool. Higher elevations are typically colder than low valleys, with average July temperatures in the mid 60°Fs. The growing season is short, approximately 90 days, and the average winter temperature is around 17°F. Clouds and fog are common and the area receives a relatively large amount of precipitation. Combined, between 127 cm to 178 cm (50" to 70") of rain and snow fall in the region annually (Thompson and Sorenson 2000).

Northern hardwoods and boreal forest species dominate the forests of the region. The higher elevations exhibit typical mountain forest zonation, with northern hardwood forests grading into yellow birch and red spruce forests, which then grades into higher elevation forests dominated by spruce and fir. Valleys are predominantly forested with northern hardwoods and various amounts of white pine (*Pinus strobus*) and hemlock (*Tsuga canadensis*). Low, south-facing slopes typically contain red oak (*Quercus rubra*).

The Deerfield Wind Project area sits atop two mountaintops. Elevation ranges from 850 m (2,790') to 950 m (3,120'). The Eastern Expansion Area is on a higher ridgeline that is steeper sided than the Western Expansion Area. The mountaintops are forested. Northern hardwood forests are dominant on the lower slopes on both mountains and along much of the ridgeline at the Western Expansion Area. Montane yellow birch – red spruce forest and red spruce – northern hardwood forests are more common at higher elevations. Small areas of montane spruce – fir forest also occur, primarily near the highest elevations of the Eastern Expansion Area.

### **1.3 Survey Overview**

Field investigations for daytime and nocturnally-migrating birds were conducted by Woodlot Alternatives, Inc. (Woodlot) during the fall of 2004. The overall goals of the investigations were to:

- investigate the magnitude and flight patterns of diurnally-migrating raptors (hawks, falcons, harriers, and eagles) across the project area and the surrounding vicinity ; and
- document the passage of nocturnal avian migration in the vicinity of the Deerfield Wind Project area, including the number of migrants, their flight direction, and their flight altitude.

The Deerfield Wind Project is unique in that it is expanding upon the existing Searsburg Wind Facility, operated by GMP. Previous investigations for that project included daytime and nighttime studies of bird migration. This included hawk migration surveys in 1993 and 1994 (Martin 1993, 1994), breeding bird surveys (Capen and Coker 1994), nocturnal migration surveys (Kerlinger 1995, 1997), and an assessment of impacts to these resources (Kerlinger 1998). The fall 2004 migration surveys add to that knowledge base through a replication of some of that previous work and an expanded survey scope through the use of new methods.

The field surveys included day-time raptor migration surveys and a radar study of avian nocturnal migration activity. Surveys were conducted between September 16 and October 29, 2004. A total of 20 days of raptor surveys and 30 nights of radar surveys were targeted for this work.

Raptor surveys were conducted for 10 days. The survey sites and methods largely mimic those from previous raptor surveys conducted for the existing facility. One of the survey sites was the same as that used in those previous studies. The other site was in the same general area as the previous work (along the same ridgeline) area but took advantage of views provided by the existing facility that were not available during that previous work.

Radar surveys were conducted at three locations during the study, though only two of those three sites were surveyed during any given night within the study period. One survey site was in the Western Expansion Area and was surveyed during each night while

survey effort was split between the other two sites, which included the existing facility (near the Eastern Expansion Area) and a low elevation site located just west of the Western Expansion Area.

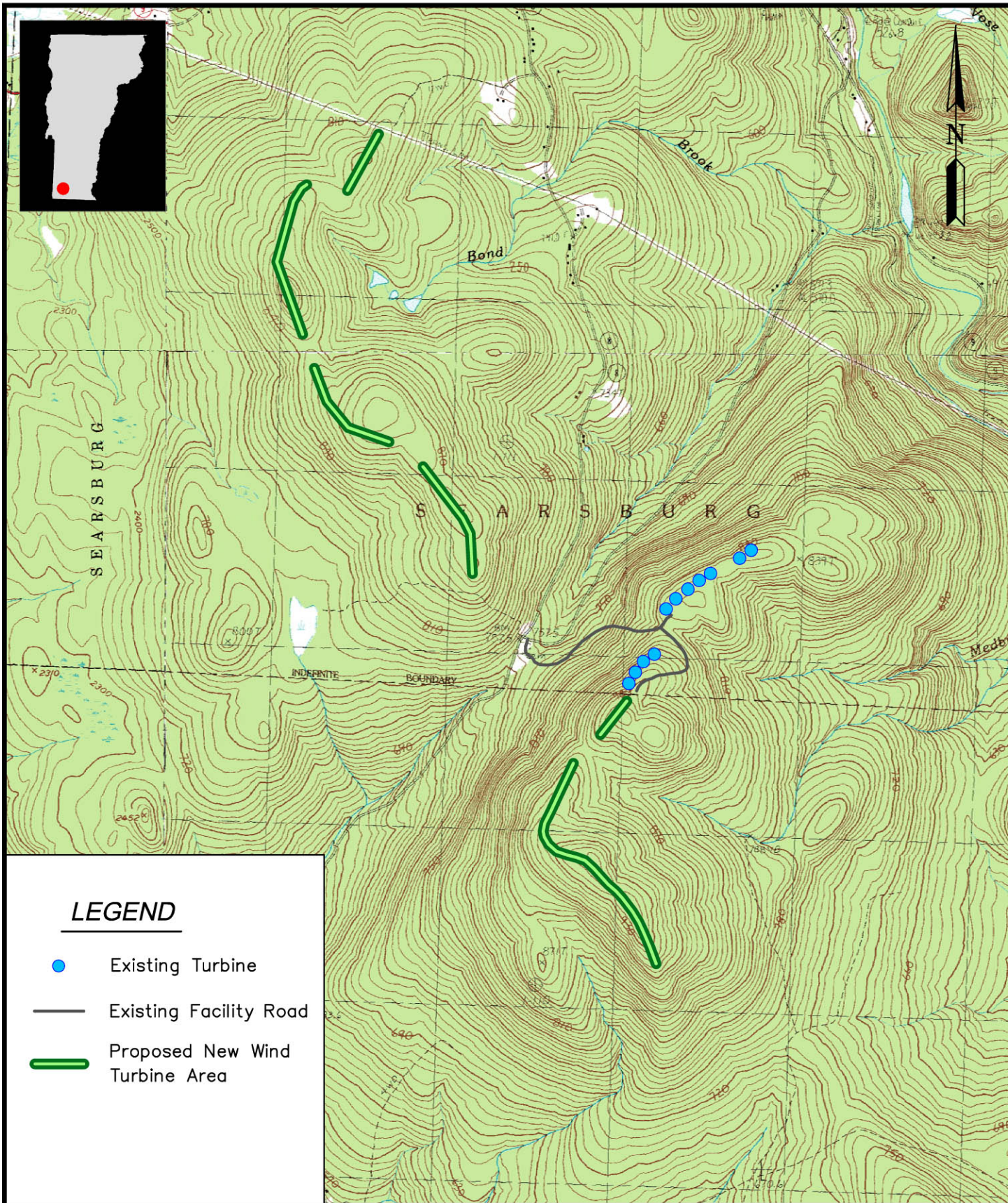

**LEGEND**

- Existing Turbine
- Existing Facility Road
- Proposed New Wind Turbine Area

PREPARED BY:



DATE: January 2005

SCALE: 1" = 2500'

JOB NO. 104145

FILE: Location.dwg

*Figure 1*  
**Project Location Map**  
**Searsburg Wind Project**  
**Searsburg, Vermont**

REV.

## 2.0 Methods

The avian survey methods and schedule described in this section were initially developed in a draft avian survey study plan circulated and reviewed by the biological subcommittee of the Searsburg Expansion Collaborative Team. This subcommittee consists of federal and state resource agency staff members and other interested parties. Comments on the study plan were discussed with the subcommittee at two meetings and a subsequent conference call held in the summer of 2004. The input provided through this process was considered when finalizing the study methods and survey schedule described below.

### 2.1 Diurnal Raptor Surveys

#### *Field Surveys*

Raptor surveys were conducted at two locations in the project area: one at the existing facility and one at the meteorological measurement tower (MET Station 690) in the Western Expansion Area (Figure 2). Of these two sites, the one at the Western Expansion Area was near the site used during the previous surveys by Martin (1993, 1994). The other one took advantage of increased visibility at the existing facility that was not available during Martin's surveys.

Surveys at the existing facility were conducted at wind turbine 8 (WTG#8), near the southern end of the existing facility. On a clear day, the site provided a view of the ridges and valleys north to the Mount Snow - Haystack Mountain range, a view west of the Western Expansion Area, and a view east of the seven northern turbines (WTG #1-7).

At the Western Expansion Area, surveys were conducted from a temporary platform approximately 4 m (13') above the ground near the existing wind measurement (MET) Station 690. Forest harvesting, conducted in previous years in the area has resulted in a young stand of trees approximately 3.5 m (12') tall surrounding the survey site and the platform allowed for views over the short forest canopy. This provided relatively clear views southeast, to the existing facility, and to the west into the Yaw Pond Brook valley. Additionally, broken views over some taller treetops were available to the northwest, north, and northeast.

Hawks migrate by expending as little energy as possible. To do this, they use a soaring flight strategy and migrate during the day, when atmospheric conditions are most suitable for this type of flight. Those conditions typically include warm, clear to partly sunny conditions. These conditions typically occur on seasonably warm days with light to strong winds from a northerly direction (during the fall migration period). Sunny conditions allow for thermals of warm, rising air to develop, which hawks use to gain flight altitude. Windy conditions provide tail winds when soaring and also provide a laminar flow of air across the land. When that laminar flow of air meets certain

landscape features, such as long uninterrupted ridgelines, these winds transform to updrafts that raptors may also use to soar long distances.

Surveys took place on a total of 20 days between September 2 and October 31, 2004, and were conducted from 9 am to 3 pm to target the time of day when the strongest thermal lift is produced and the majority of hawk migration occurs. Ten days were spent at the existing facility and 10 were spent at the Western Expansion Area. These survey days targeted days with weather forecasts for the conditions described above.

Surveys were based on methods utilized by the Hawk Migration Association of North America (HMANA). Observers scanned the sky and surrounding landscape for raptors flying into the survey areas. Observations were recorded onto HMANA data sheets, which summarize the data by hour. More detailed notes on each observation (including location and flight path, flight height, activity of the animal, etc.) were recorded while in the field. Height of flight was categorized as less than or greater than 100 m (330') above ground, which is within the rotor swept area of the proposed wind turbines. Nearby objects with known heights such as the MET stations, existing wind turbines, or nearby trees were used to gauge flight height. When possible, the general flight paths of individuals observed were plotted on topographic maps of the project area.

Hourly weather observations, including wind speed, direction from which the wind was coming, temperature, percent cloud cover, and precipitation, were recorded on HMANA data sheets. Birds that flew too rapidly or were too far to accurately identify were recorded as unidentified *buteo*, unidentified *accipiter*, unidentified *falcon*, unidentified eagle, or if the identification of Genus was not possible, unidentified raptor.

#### *Data Analysis*

Field observations were summarized by species for each survey day and for the whole survey effort. This included a tally of the total number of individuals observed for each species and the observation rate (birds per hour). The species composition of birds observed flying below and above 100 m (320') was also determined. Finally, a qualitative review of the mapped flight location data was made to identify any concentration areas for migrating hawks.

Observations from the project area were compared to other site totals of raptor survey data from local HMANA hawk watch sites available on the HMANA web site. The closest fall HMANA watch sites were Putney Mountain in southeastern Vermont, a site in southern New Hampshire, and a few sites in northwestern Massachusetts – all ranging from approximately 20 to 100 miles away from the project site area.



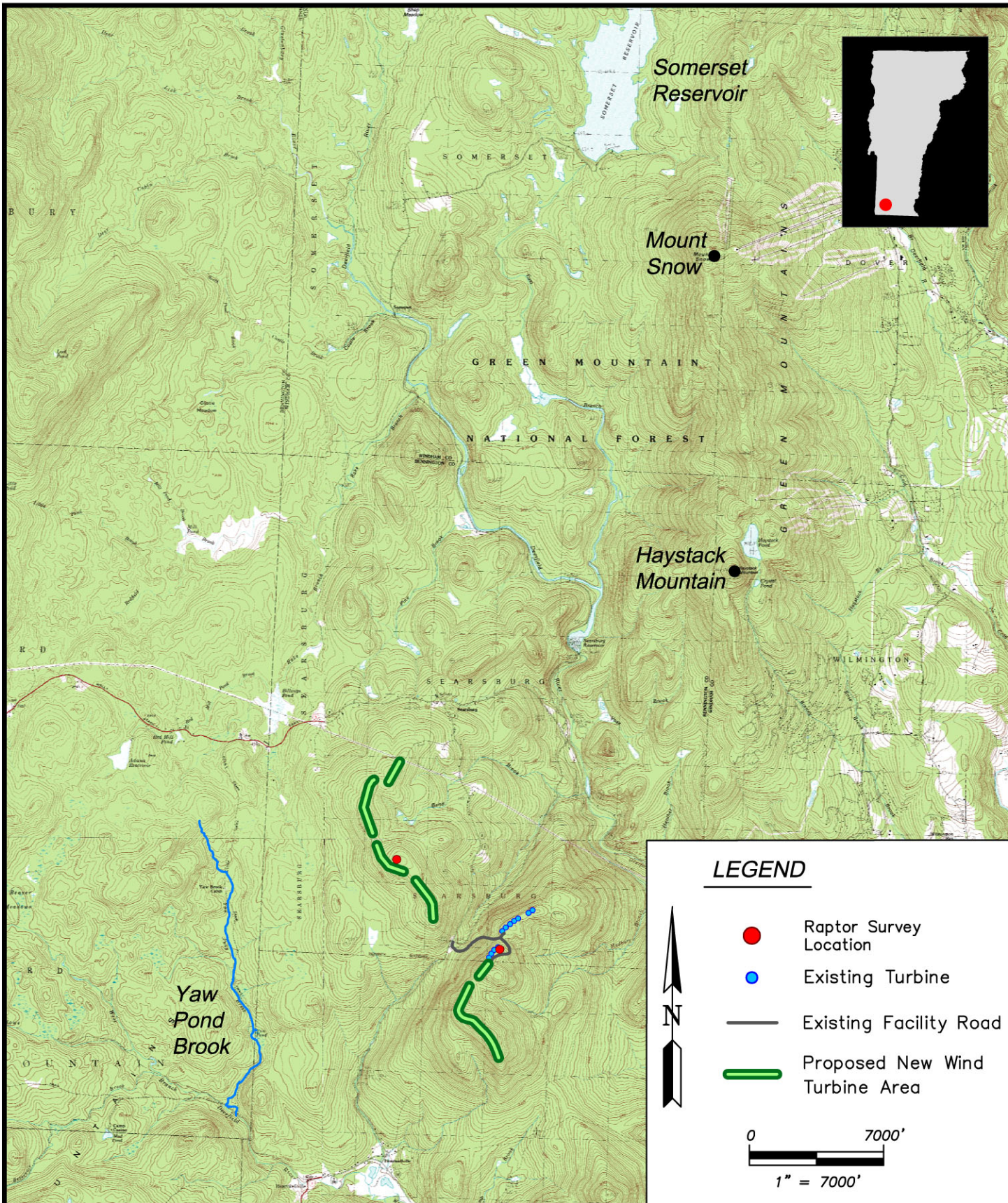

PREPARED BY:



**WOODLOT**  
ALTERNATIVES, INC.  
ENVIRONMENTAL CONSULTANTS

DATE: January 2005

SCALE: 1" = 7000'

JOB NO. 104145

FILE: Location.dwg

*Figure 2*  
**Raptor Survey Locations**  
**Searsburg Wind Project**  
**Searsburg, Vermont**

REV.

## 2.2 Nocturnal Radar Surveys

### *Field Methods*

Two radar stations were used at three sites for this study. Each station consisted of marine surveillance radar similar to that described by Cooper *et al.* (1991).

The three radar sites that were used are shown in Figure 3 and included:

- Existing Facility site – 879 m (2,884') elevation: This was a mobile radar station positioned near Turbine 8 of the Existing Searsburg Facility. The station included a radar mounted to a boom van that lifted the antenna up to the height of the surrounding forest canopy,
- Western Expansion Area site – 914 m (2,999') elevation: This was a stationary radar station located within the met tower clearing on the ridgeline of the Western Expansion Area. The radar antenna was mounted to the top of a 4 m (13') tower, which corresponded approximately to the height of the surrounding low forest canopy there. The remainder of the radar station equipment was housed in an on-site shack, and
- Low Elevation site – 664 m (2,178') elevation: This was a mobile radar station located in Yaw Pond Brook valley, west of the Western Expansion Area site. This was the same mobile station that was used at the Existing Facility site. Generally, this site was sampled on alternate nights than the Existing Facility. The boom van was able to extend the antenna to approximately the same height as the surrounding tree canopy.

The radar has a peak power output of 12 kW and has the ability to track small animals, including birds, bats, and even insects, under certain settings of the radar functions. It cannot, however, readily distinguish between different types of animals being detected. Consequently, all animals observed on the radar screen are called targets. To detect small targets such as birds and bats, the radar's anti-rain and anti-sea settings were turned down and the gain was turned up. The radar was operated at its shortest pulse length to increase the detection of small targets. The radar has an echo trail function that maintains past echoes of trails. This function has several time periods that can be used, after which echoes are successively erased from the radar screen. During all operations, the radar's echo trail was set to 30 seconds.

The radar was equipped with a 2-m waveguide antenna. The antenna has a vertical beam height of 20° (10° above and below horizontal). At each survey site, the radar antenna was aligned to magnetic north during each night of operation. At the western expansion facility, this was done by positioning the tower and platform permanently throughout the duration of the survey period in the correct direction. For the mobile station, this was accomplished by parking the van in the same location aligned to magnetic north during each night of survey.

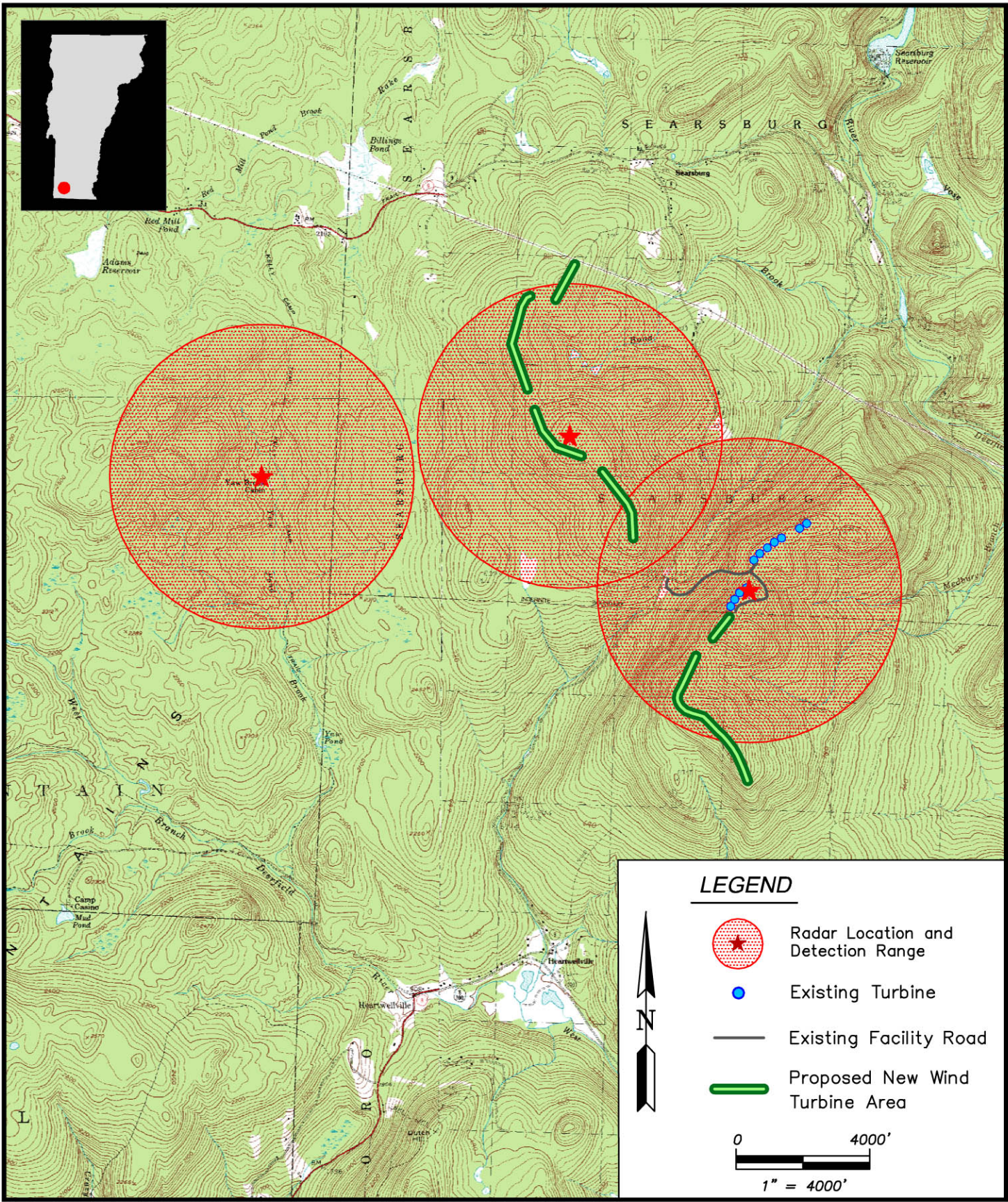

PREPARED BY:



**WOODLOT**  
ALTERNATIVES, INC.  
ENVIRONMENTAL CONSULTANTS

DATE:	January 2005
SCALE:	1" = 4000'
JOB NO.	104145
FILE:	Location.dwg

*Figure 3*  
**Radar Location Map**  
**Searsburg Wind Project**  
**Searsburg, Vermont**

REV.

During data collection the radar was operated in two modes. In the first radar mode, surveillance, the antenna spins horizontally. During surveillance operation, the radar surveys the airspace around the radar and targets moving through the area are detected. With the echo trail function, the flight direction of targets can be observed. In the second mode of operation, vertical, the antenna is rotated 90° to vertically survey the airspace above the radar (Harmata *et al.* 1999). In vertical mode, target echoes do not provide directional data but do provide information on the altitude of targets passing through the vertical, 20° radar beam.

The radar was operated at a range of 1.4 km (0.75 nautical miles). At this range, the echoes of small birds can be easily detected, observed, and tracked. At greater ranges, larger birds can be detected but the echoes of small birds are reduced in size and restricted to a smaller portion of the radar screen, reducing the ability to observe the movement pattern of individual targets. The limits of the range setting used are provided for each radar station location on Figure 3.

Radar surveys were conducted from sunset to sunrise. Thirty nights of surveys were targeted for surveys between September 16 and October 29, 2004. Because the anti-rain function of the radar must be turned down to detect small songbirds and bats, surveys could not be conducted during periods of inclement weather. Therefore, surveys were targeted largely for nights without rain. However, in order to characterize migration patterns during nights without optimal conditions, some nights with weather forecasts including occasional showers were sampled. The operation of the radar for each of these nights is presented in Table 1.

<b>Table 1. Survey effort** for Fall 2004 radar surveys at the Deerfield Wind Project.</b>				
<b>Night of</b>	<b>Sunset</b>	<b>Sunrise</b>	<b>Hours of Survey*</b>	<b>Weather Conditions</b>
Sep 16	7:01 PM	6:34 AM	5	clear sky, fog late in the evening
Sep 18	6:58 PM	6:36 AM	11	partly cloudy to clear in the AM
Sep 19	6:56 PM	6:37 AM	11	clear sky, moderate wind
Sep 20	6:54 PM	6:38 AM	11	mostly cloudy to clear in the AM
Sep 21	6:52 PM	6:40 AM	11	cloudy with moderate wind
Sep 22	6:51 PM	6:41 AM	11	cloudy to start clearing in the AM
Sep 23	6:49 PM	6:42 AM	11	clear sky with no wind
Sep 24	6:47 PM	6:43 AM	11	cloudy with light to moderate wind
Sep 25	6:45 PM	6:44 AM	5	partly cloudy with moderate wind
Oct 8	6:22 PM	6:59 AM	11	cloudy with fairly strong wind
Oct 9	6:21 PM	7:00 AM	13	cloudy with occasional light rain
Oct 10	6:19 PM	7:01 AM	13	cloudy and foggy, strong wind
Oct 11	6:17 PM	7:02 AM	13	clear sky with moderate wind
Oct 12	6:16 PM	7:03 AM	11	partly cloudy, light winds
Oct 13	6:14 PM	7:04 AM	12	partly cloudy no wind
Oct 14	6:12 PM	7:06 AM	2	cloudy with light rain early
Oct 16	6:09 PM	7:08 AM	13	light rain to freezing rain in the AM
Oct 17	6:07 PM	7:09 AM	10	cloudy, occasional rain
Oct 18	6:06 PM	7:10 AM	6	cloudy to start, rain at midnight
Oct 20	6:03 PM	7:13 AM	13	cloudy with moderate wind
Oct 21	6:01 PM	7:14 AM	13	cloudy with moderate wind, snow
Oct 22	6:00 PM	7:15 AM	13	cloudy with moderate winds
Oct 23	5:58 PM	7:17 AM	13	clear with no wind
Oct 24	5:56 PM	7:18 AM	9	cloudy and foggy, light wind
Oct 25	5:55 PM	7:19 AM	13	clear sky, light winds
Oct 26	5:54 PM	7:20 AM	13	cloudy with strong winds
Oct 27	5:52 PM	7:22 AM	11	clear sky, solar eclipse
Oct 29	5:49 PM	7:24 AM	11	cloudy and foggy, rain late

\* Indicates the number of one-hour periods, beginning at sunset, during which radar data collection occurred. These may not be consecutive or include both surveillance and vertical radar operation.

\*\* Survey effort represents the time span during which radars were operated at each of the two radar sites for that night.

### *Data Collection*

The radar display was connected to video software of a computer. For each hour of survey, during surveillance mode, 15 one-minute samples of the radar display were recorded onto the computer. During vertical mode, a single 10-minute video sample was recorded. The video samples were recorded on the following schedule:

- Seven 1-minute samples during the first 15 minutes after sunset,
- One 10-minute vertical sample during the next 30 minutes,
- Eight 1-minute samples during the last 15 minutes of the hour,
- Repetition of this schedule during each 1-hour period after sunset.

During the 30-minute period when vertical data were recorded, additional information was also recorded, including weather observations and ceilometer observations. Weather data that was recorded included wind speed and direction, cloud cover, temperature, and precipitation. Ceilometer observations involved directing a one million candlepower spotlight vertically into the sky in a manner similar to that described by Gauthreaux (1969). The ceilometer beam was observed for 5 minutes by eye to document and characterize low-flying (below 100 m) targets. The ceilometer was held in-hand so that any birds, bats, or insects passing through it could be tracked for several seconds, if needed. On nights with a full moon and clear skies, the ceilometer beam was too diffuse to readily detect birds and bats. Moonwatching (Lowery 1951) was used on those nights. All observations of birds, bats, or heavy insect occurrence were recorded after each period of ceilometer observation. This information was used, in part, during data analysis in the determination between insect data and bird and bat targets.

### *Data Analysis*

Video recording software automatically recorded the 1-minute and 10-minute samples of the radar screen during each hour of operation. Targets were identified as birds and bats versus insects based on their speed. The speed of targets was compared with wind speed and direction and only targets traveling faster than approximately 6 m per second were included as non-insect (and consequently bird or bat) targets. Nightly visual observation notes were also considered during this determination.

The 1-minute video samples were analyzed using a digital video analysis software tool developed by Woodlot. Target tracks traveling fast enough to be bird or bat targets were tracked using the software tool and the time, location, and flight direction of each was output to a spreadsheet. For the vertical samples, the entry point of targets passing through the vertical radar beam was recorded with the software tool and the time and flight altitude above the radar location was output to a spreadsheet. These data were then used to calculate passage rate, flight direction, and flight altitude of targets for each survey site.

Hourly passage rates (in 1-hour increments post sunset) were calculated by tallying the total number of targets in the 1-minute samples for each hour and correcting for the

number of samples collected in that hour. That estimate was then corrected for the radar range setting that was used in the field and was expressed as targets/km/hour (t/km/hr)  $\pm$  1 SE. The hourly rates were used to determine passage rates for each night and the entire season.

Mean target flight directions ( $\pm$  1 circular SD) were summarized in a similar manner: by hour, night, and for the entire season. Flight direction analysis and statistical analyses were conducted using software designed specifically to analyze directional data (Oriana2<sup>®</sup> Kovach Computing Services). The statistics used for this are based on Batschelet (1965), which take into account the circular nature of the data. Nightly wind direction was also calculated using similar methods and supplemented by data collected at existing met tower station 72 (eastern side) and station 690 (western side), near the radar sites. Mean wind speed was calculated using linear statistics (Zar 1999).

Flight altitude data were summarized using linear statistics. Mean flight altitudes ( $\pm$  1 SE) were calculated by hour, night, and overall season. The percent of targets flying below 100 m (the height below the maximum within the rotor swept area of proposed wind turbines) was also calculated hourly, for each night, and for the entire survey period.

## 3.0 Results

### 3.1 *Diurnal Raptor Surveys*

The raptor surveys were generally conducted on days with suitable hawk migration weather (warm days with clear skies and light to moderate winds). During the September surveys temperatures ranged from 60° F to 80° F, while in October temperatures were typically 40° F to 65° F. Winds were generally from a northerly direction although several days included unexpected winds from the east or southeast. On the days with the most suitable conditions, the development of thermals was evident as temperatures increased and cumulus clouds formed. On other days, however, visibility was inhibited by morning fog that either cleared as temperatures and wind speed increased or remained throughout most of the day.

The surveys were conducted on 20 days for a total of 117 hours of observation (60 hours at the existing facility and 57 hours at the Western Expansion Area). During that time, 872 raptors representing 11 species<sup>1</sup> were observed, yielding an overall observation rate of 7.45 birds/hour (Appendix A Table 1). More raptors were observed at the Western Expansion Area (725) than at the existing facility (147) and the passage rates observed were 12.72 and 2.45 birds/hour, respectively.

---

<sup>1</sup> Eleven definitive species were observed. Several other categories of unidentified birds (identified only to Genus or just as “raptor”) were also observed. These latter observations were not used in the calculation of the number of species observed.

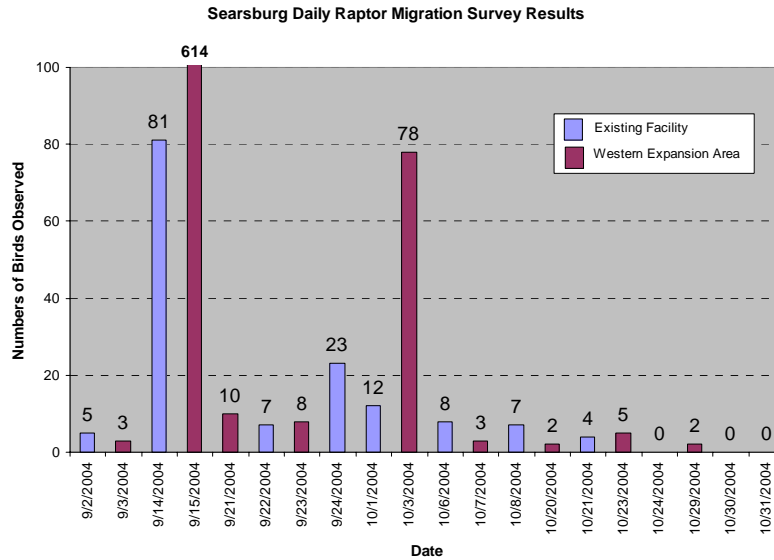
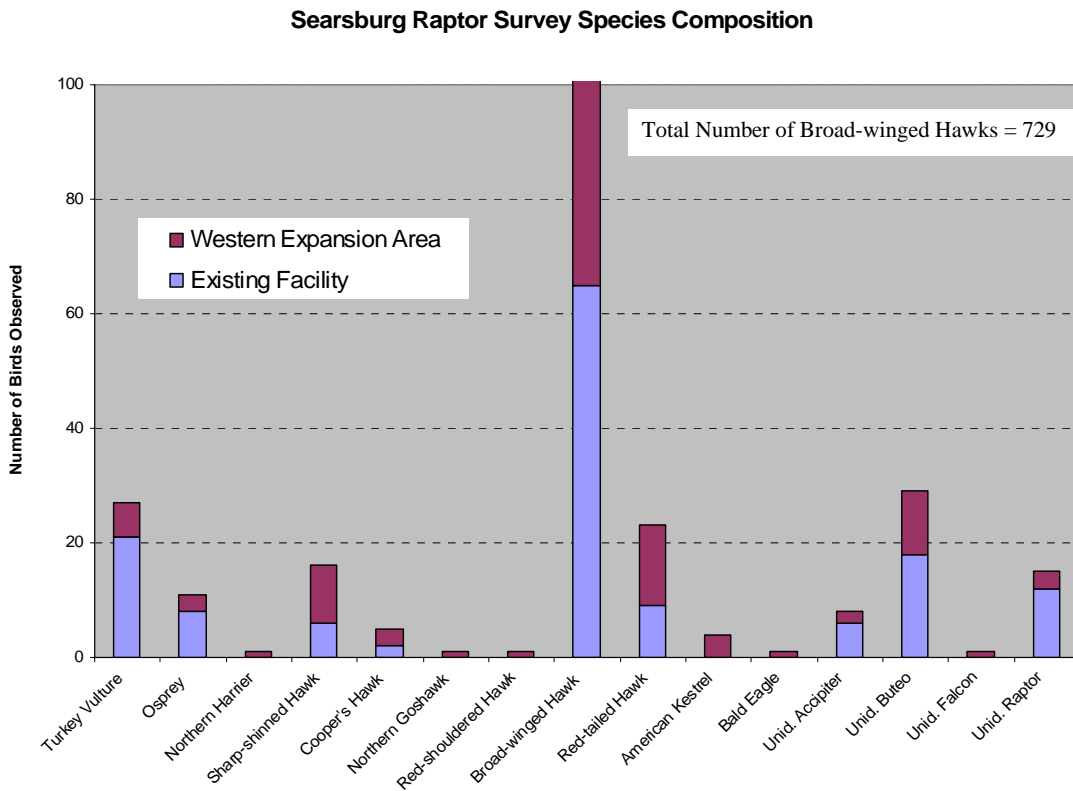

**Figure 4.** Daily raptor survey observations

Broad-winged hawks (*Buteo platypterus*) were the most abundant hawks observed during the survey, at a total of 729. Turkey vultures (*Cathartes aura*)<sup>2</sup> and red-tailed hawks (*Buteo jamaicensis*) and were the next most abundant, with 27 and 23 observed, respectively, followed by sharp-shinned hawks (*Accipiter striatus*), with 16 observed (Figure 5). Fifty-three individuals were not identifiable due either to a distance in excess of 3 miles from the observation site or very brief occurrences within the view of the surveyors. These were mostly from the genus *Buteo*, although several unidentified accipiters were observed.

<sup>2</sup> While turkey vultures are not true raptors they are diurnal migrants that exhibit flight characteristics similar to hawks and other raptors and are typically included during hawk watch surveys.





**Figure 5.** Raptor species composition

The timing of raptor sitings within the day varied. Few sitings occurred during the first hour of the survey period while observations reached near peak numbers during the third survey hour. A second, smaller peak was experienced during the last hour of the day as well (Figure 6). This pattern did vary from day to day. However, the peak of activity for each species typically occurred somewhere between the third and sixth hour of the survey periods (Appendix A Table 2).

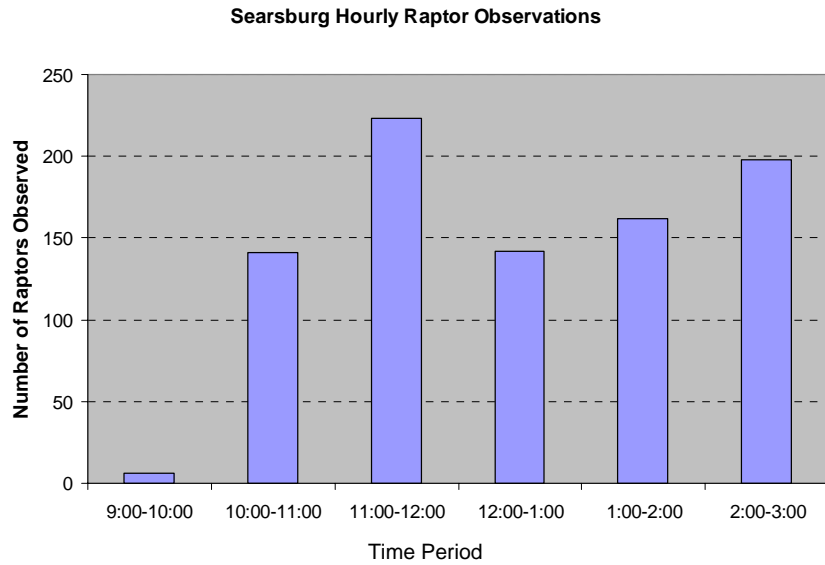

**Figure 6.** Hourly raptor survey sightings

Flight heights were categorized as below or above 100 m (330'), which is comparable to the height within the rotor swept area of proposed wind turbines. Overall, 9% of the raptors observed were flying less than 100 m above the ground (Appendix A Table 3). Trends in flight altitudes between species were observed and Figure 7 depicts differences in the proportion of individuals of each species that were observed flying below 100 m. Proportionally more of the small species, such as the accipiters and falcons, were consistently observed flying lower than the larger species.

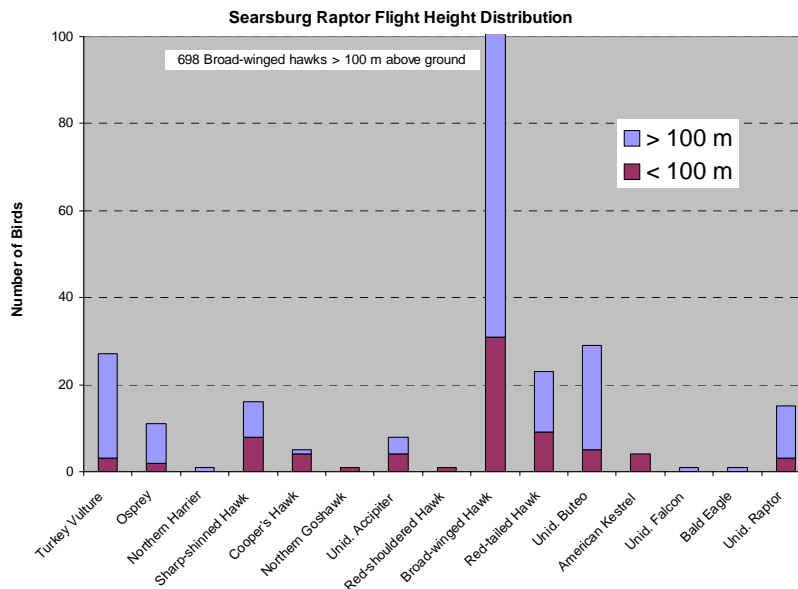

**Figure 7.** Raptor flight height distribution

Raptors were typically observed flying over valleys and side slopes. Most raptors were first seen well to the north of the project area near Somerset Reservoir and Mount Snow. The flight path from there was typically either southwest, west of the Western Expansion Area, or southward, toward the Western Expansion Area and existing facility. These latter birds then either followed the valley north of the existing facility (State Route 9) southeastward, toward Harriman Reservoir, or followed the valley (State Route 8) between the existing facility and Western Expansion Area southward. The predominant flight paths observed during the raptor surveys are depicted on Figure 8.

Because observations were recorded from the existing facility, some opportunity to observe the flight pattern of migrating hawks near operating turbines occurred. Some birds were observed flying over or within the limits of the existing facility. These typically included turkey vultures, although two sharp-shinned hawks were also observed. Several turkey vultures were observed flying between turbines, which placed them within the blade-swept height zone. These birds were observed 'lifting up' as they approached a turbine, flying directly over the moving blades, and then dropping back down on the opposite side. The two sharp-shinned hawks that were observed flew between the turbines but at heights of only a few meters above the treetops. This placed these hawks well below the blade-swept area of those turbines. This low flight height of the observed sharp-shinned hawks is typical for that species.

**LEGEND**



- Raptor Survey Location
- Existing Turbine
- Existing Facility Road
- Proposed New Wind Turbine Area

0 7000'  
1" = 7000'

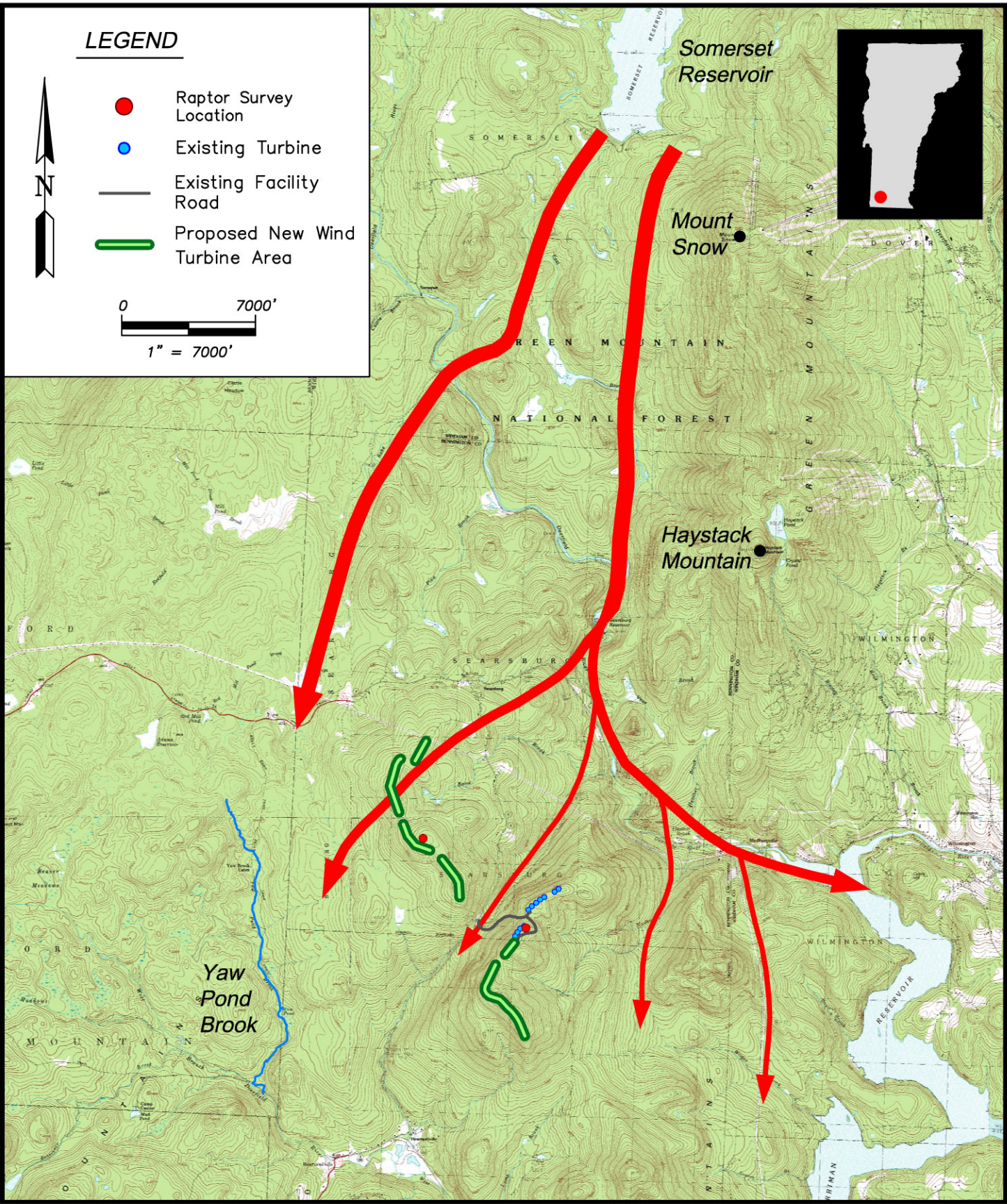
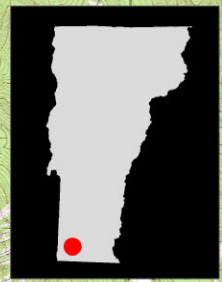

PREPARED BY:



DATE: January 2005

SCALE: 1" = 7000'

JOB NO. 104145

FILE: Location.dwg

*Figure 8*  
**Raptor Flight Paths**  
**Searsburg Wind Project**  
**Searsburg, Vermont**

REV.

### **3.2 Radar Survey Results**

Radar surveys were conducted during 595 hours on 28 nights between September 16 and October 29, 2004. The three radar sites provided good coverage of the airspace surrounding each site because of their location near trees on top of the ridgeline and the uniformity of the design of the radar stations at each sample site. The three sites are briefly described in Section 2.2.

Objects on the ground (such as trees, structures, and the ground itself) detected by the radar cause returns on the radar screen (echoes) that appear as blotches called ground clutter. This happens due to the 20 degree beam height, which includes 10 degrees above horizontal and 10 degrees below horizontal. Because the 10 degrees below the horizontal the radar is essentially seeing the ground care must be taken to position the antenna in such a way to restrict those echoes from ground clutter to an area immediately surrounding the radar site. This was done by placing the radars in small forest canopy openings. Within each opening, the radar antenna was elevated to the height of the top of the canopy. With this configuration, the lower part of the beam reflects back to the antenna from the immediately surrounding vegetation and is displayed as a blotch of clutter in the center of the radar screen. The remainder of the beam extends beyond the surrounding canopy to detect targets in the air. By placing the antenna equal to the forest canopy maximizes the amount of the beam that extends beyond the canopy opening and lowers the altitude at which birds flying above the forest canopy can be detected.

As explained above, the stationary radar station was set up to elevate the antenna to the height of the surrounding tree canopy using a tower. The mobile station had the ability to do the same at each of the two sites it was used to sample at, through the use of the boom on the van. Elevating the antenna to the same height of the tree canopy at all three of the sites provided for a relatively similar coverage of the radar survey area around each site. Additionally, because the antenna was aligned with the canopy in this way, that area above the canopy that could reliably be sampled was maximized. Exceptions to this were small patches of ground clutter that appeared further out on the radar screen at each of the sites. The similarity in application of the radar system to the surrounding vegetation at each of the sites, however, reduced these areas of ground clutter as much as possible at each site. These areas of clutter did not significantly affect the radar's ability to detect and track targets, however, as targets were observed passing through these areas.

#### *Passage Rates*

A total of 43,724 targets were identified in the 2,025 one-minute radar video samples that were collected during the field surveys. The overall passage rate during the entire study was  $178 \pm 24$  t/km/hr. Nightly passage rates varied at each site from  $7 \pm 2$  t/km/hr on October 21 at the existing facility to  $1121 \pm 207$  t/km/hr on October 13 at the Western Expansion Area (Figure 9; Appendix B Table 1).

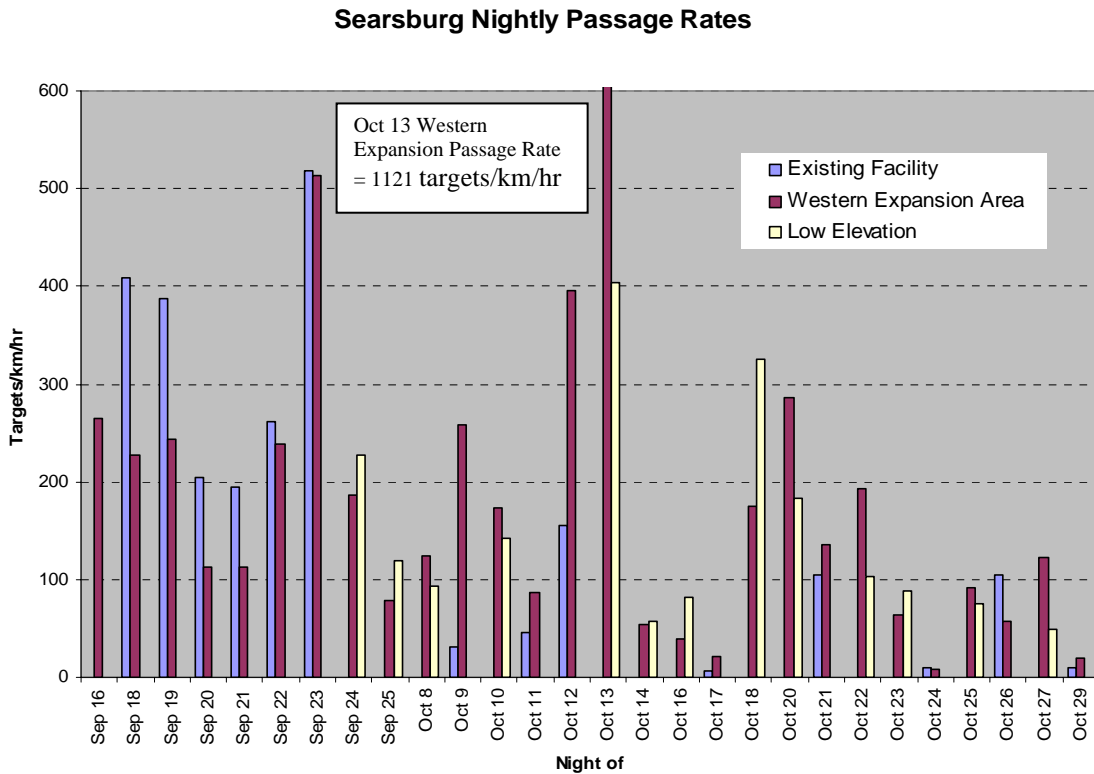

**Figure 9.** Nightly passage rates

Individual hourly passage rates throughout the entire season varied from 1 to 2096 t/km/hr (Appendix B Tables 2 – 4). The pattern of hourly passage rates varied between sites. Hourly passage rates at the existing facility peaked 5 to 6 hours after sunset and gradually declined while those at the Western Expansion Area peaked slightly later but generally remained more even throughout the night (Figure 10). The pattern of hourly passage rates at the low elevation site was similar to that observed at the Western Expansion Area, with generally low variability through the middle part of the night, though no sole peak in rate at any particular hour was observed.

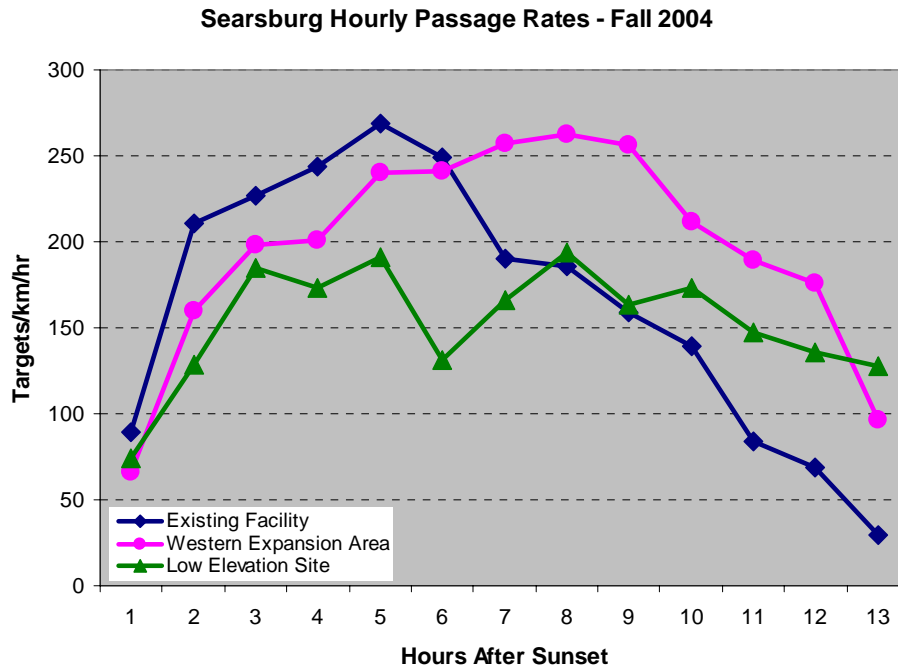

**Figure 10.** Hourly passage rates

*Flight Direction*

The overall mean flight direction through the project area was southwest, at  $212^{\circ} \pm 55^{\circ}$  (Figure 11). The mean flight direction of the entire season at each site varied from  $194^{\circ} \pm 48^{\circ}$  at the existing facility to  $223^{\circ} \pm 56^{\circ}$  at the Western Expansion Area (Appendix B Table 1; Figure 11). Nightly flight directions at the Western Expansion Area and existing facility were generally similar while greater differences were observed between the Western Expansion Area and low elevation site. The mean flight directions observed on each night at each site are provided in Appendix C.

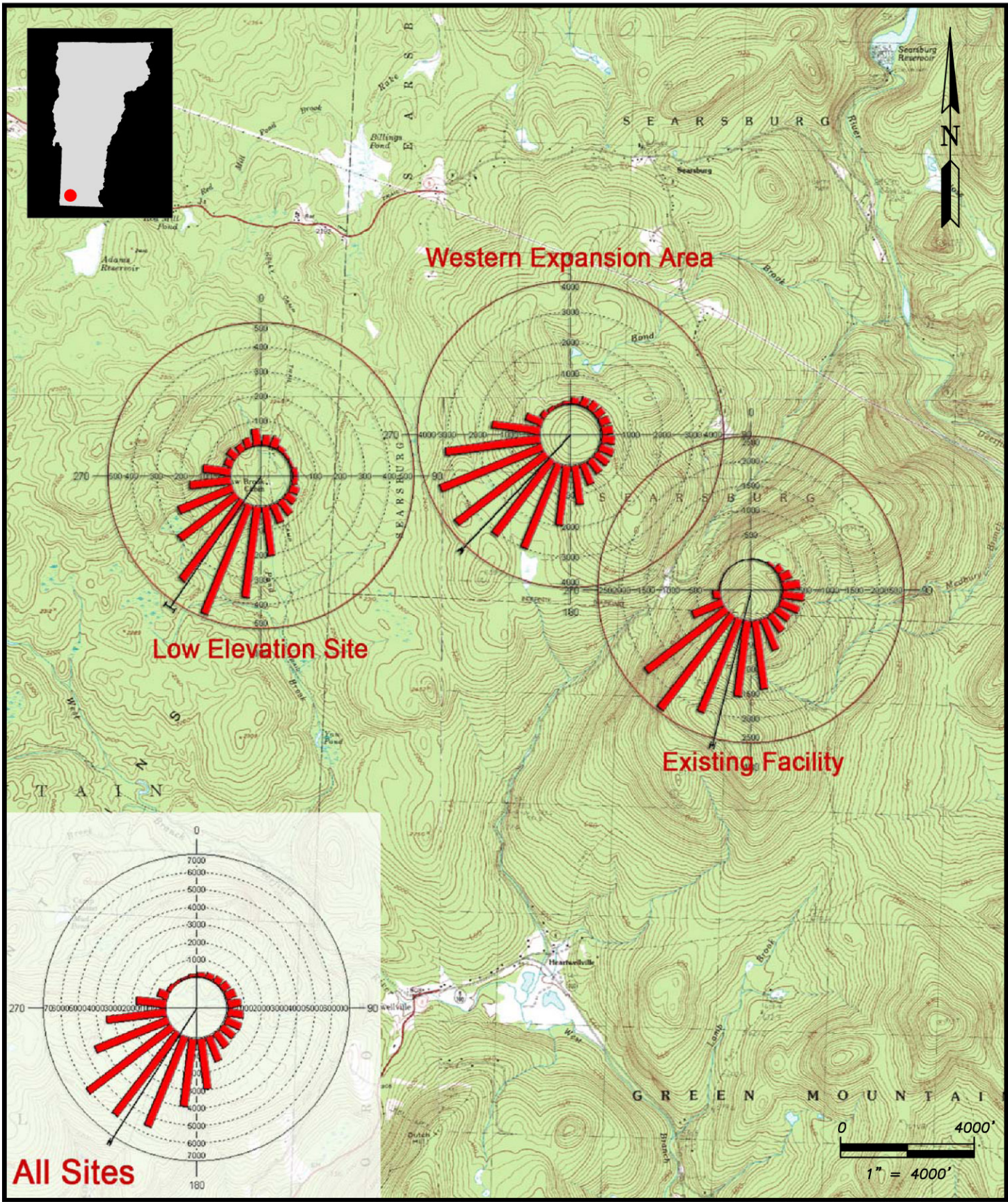

PREPARED BY:

**WOODLOT**  
ALTERNATIVES, INC.  
ENVIRONMENTAL CONSULTANTS

DATE: January 2005

SCALE: 1" = 4000'

JOB NO. 104145

FILE: Location.dwg

**Figure 11**  
*Fall 2004 Target Flight Directions*  
**Searsburg Wind Project**  
**Searsburg, Vermont**

REV.



### *Flight Altitude*

A total of 20,251 targets were identified during the analysis of the 10-minute vertical radar data samples. The mean flight altitude [above ground level] of all targets for all sites was  $566 \pm 23$  m ( $1,857 \pm 75'$ ). Flight altitude for the entire season was lowest at the Western Expansion Area ( $503 \pm 21$  m;  $1,650 \pm 69'$ ) and highest at the existing facility ( $624 \pm 24$  m;  $2,047 \pm 78'$ ) (Figure 12; Appendix B Table 1). Only 3% of the targets were observed flying less than 100 m ( $330'$ ) above ground level (agl). While this area includes airspace below the blade-swept zone of the turbines, no distinction was made between blade-swept and non blade-swept areas below 100 m because the finite distinction between these two zones cannot be consistently made.

There was variation between sites, with less than 1% of targets observed flying less than 100 m agl at the existing facility site and low elevation site and 5% flying less than 100 m agl at the Western Expansion Area site (Appendix B Table 5). The pattern of hourly flight altitude was similar among the sites and typically was greatest about 3 to 6 hours after sunset, followed by a gradual decline (Figure 13).

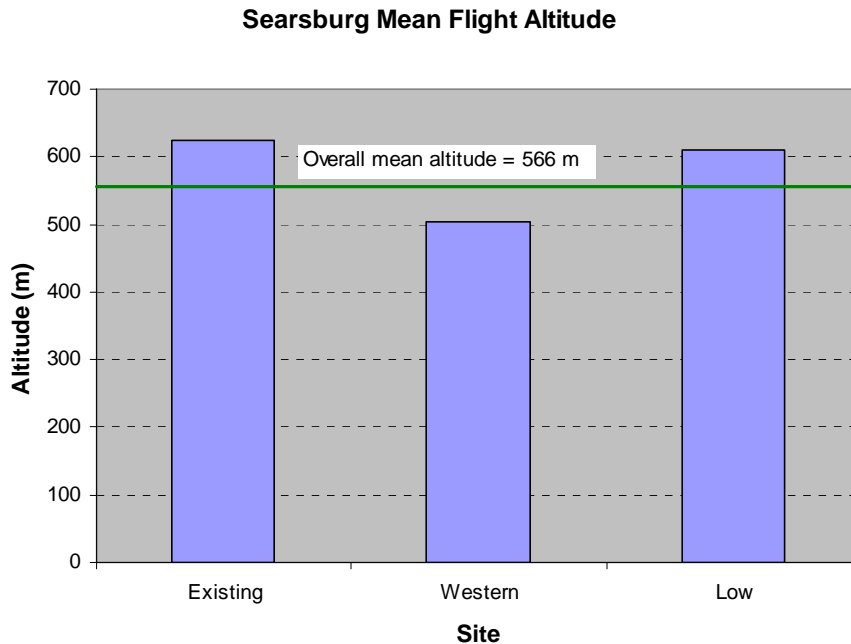

**Figure 12.** Mean flight altitude

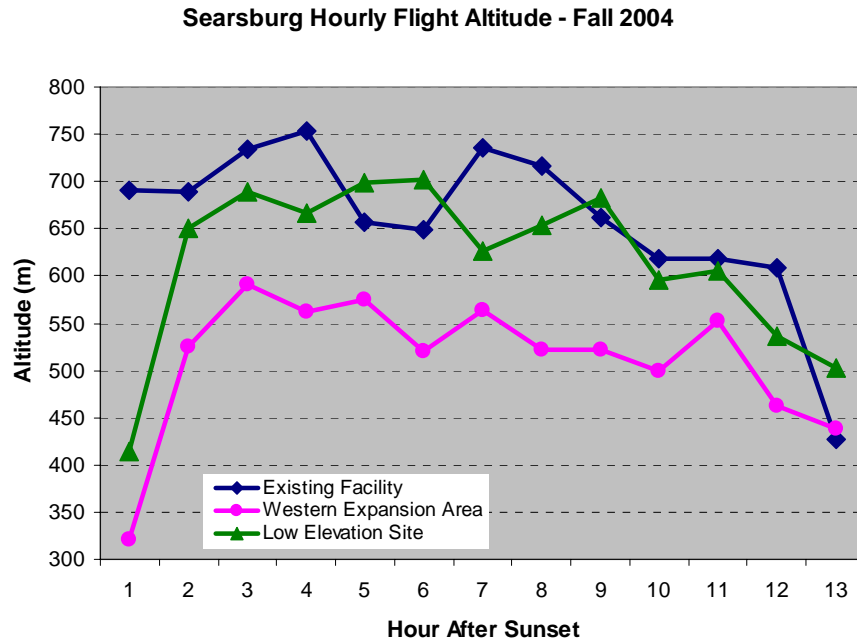

**Figure 13.** Hourly average flight altitude

*Ceilometer Observations*

Ceilometer data collected during the entire radar survey yielded a total of 41 hours of observations. Those surveys, however, resulted in very few bird or bat observations. The 12 total documented observations comprised 8 birds and 2 bats (0.4 birds and 0.1 bats per hour) at the Western Expansion Area and 2 birds (0.2 birds per hour) at the low elevation site (Appendix B Table 6).

**4.0 Discussion**

**4.1 Diurnal Raptor Surveys**

Nearly 900 migrating raptors were observed during the 20 days of field surveys. Broad-winged hawks were the most abundant species observed at Searsburg and comprised 84% of the observations. This is typical in the forested Northeast, as broad-winged hawks are regionally abundant and they typically migrate in groups called kettles, which makes them more easily observed than species that migrate singly.

The observation rate of raptors at Searsburg (7.5 birds/hour) was low compared to nearby HMANA hawk watch sites, which ranged from 12.1 to 70.2 birds/hour (Appendix A Table 4). There are several reasons for this. Initially, survey effort varies from site to site. Hawk watch locations are often only surveyed on days when the weather is optimal for raptor migration and only during the peak of the migration season. This level of

effort increases the rate of observations because relatively few hours of survey time are being targeted for the time periods when the greatest number of raptors will be migrating. Data from Pack Monadnock, New Hampshire, was collected on only 4 days in September 2004. Those days clearly targeted the peak of broad-winged hawk migration, as more than 1,800 were counted. Because so few days were sampled (a total of 28.5 hours), that site had an observation rate of 70.2 birds/hour. Alternatively, sampling only during sub-optimal raptor migration weather would decrease observations rates. During the Fall 2004 surveys some days with suboptimal raptor migration weather were sampled and fewer hawks were typically observed on those days.

Second, location can affect the magnitude of raptor migration at a particular site. Two well-known examples include Cape May, New Jersey, and Hawk Mountain, Pennsylvania. The location of these sites relative to large, regional landscape features result in large concentrations of migrating raptors. This likely happens at a smaller scale, as large river valleys and dominant ridgelines might result in more suitable migration conditions (i.e., strong thermal development, crosswinds, and updrafts). The locations of hawk counts often include large escarpments overlooking large river valleys and the most prominent peaks in a mountain range. Several of the regional hawk counts used for comparison data (Appendix A Table 4) fall into this scenario.

For example, Putney Mountain, located approximately 35 kilometers (22 miles) northeast of Searsburg is a long ridgeline located between the Connecticut and West Rivers. September 2004 surveys from that site included eight days with more than 100 broad-winged hawks recorded; one day included 917 broad-wings. Surveys at Searsburg documented one day with a significant broad-winged hawk migration during that same time period. Interestingly, the survey effort at Putney Mountain (139 hours) was very similar to that at Searsburg (117 hours) but more than five times as many hawks were observed at Putney.

Finally, visibility at a site can affect results of raptor surveys. The best hawk migration sites often provide wide, open views of not only the surrounding airspace but also the surrounding slopes and ridgelines due to open mountaintops, cleared land at the peaks, very steep topography such as at a cliff top, and, sometimes, observation towers. These views downward and over the surrounding hillsides are often needed to observe those species that migrate at lower altitudes, which includes sharp-shinned hawks and American kestrels (*Falco sparverius*). While the surveys at Searsburg included good views to distant mountains and ridgelines, they did not include abundant views of the ridgetops on which survey sites were located. The data reflects this in the limited number of sharp-shinned hawks and kestrels that were documented.

Wind can also affect raptor migration. Wind strongly affects both the propensity to concentrate along linear features (such as rivers and ridges) and the precise location of the stream of migrants relative to the linear feature. Also, concentrations of migrating birds along linear features are in part related to the phenomenon of lateral drift by crosswinds (Richardson 1998). In other words, wind speed and direction can result in changes in the location of migrants along a ridgeline from day to day but can also result

in a consistent location of migrants within an individual day. This was observed during the field surveys at Searsburg. On several days when the predominant winds were from the east and southeast, birds typically used different flight corridors. On one such day, migrating hawks were consistently observed flying south, along the downwind (west) side of Haystack Mountain and crossing through the valley between Haystack and the existing facility before continuing south and east. This flight pattern was not observed on days when winds were from the north or west.

The results of the Fall 2004 raptor surveys are somewhat similar to those of previous studies at Searsburg. Martin (1993, 1994) documented 13 species during fall migration surveys that were conducted over a 2-year period. Observation rates were 4.6 birds/hr in 1993 and 6.0 birds/hr in 1994 for an average of 5.6 birds/hr. The species composition of the observations, however, was different than that documented during the Fall 2004 surveys. Sharp-shinned and red-tailed hawks accounted for 56% of the 528 raptors observed during those surveys while they were only 5% of the 2004 observations. A valley bottom was one of Martin's survey sites, from which there may have been a greater potential of observing birds flying low over the forest canopy<sup>3</sup>. Interestingly, the flight paths documented by those surveys and the relative magnitude of migration are very similar to the 2004 surveys.

## **4.2 Radar Surveys**

Fall 2004 radar surveys documented migration activity and patterns in the vicinity of the Deerfield Wind Project area. In general, migration activity and flight patterns varied between and within nights. Nightly variation in the magnitude and flight characteristics of nocturnally-migrating songbirds is not uncommon and is often attributed to weather patterns, such as cold fronts and winds aloft (Hassler *et al.* 1963, Gauthreaux and Able 1970, Gauthreaux 1971, Richardson 1972, Able 1973, Bingman *et al.* 1982, and Gauthreaux 1991).

### *Passage Rates*

As indicated above, weather patterns are probably the largest factor affecting the magnitude of bird migration, particularly at inland sites. In the fall, the passage of low pressure systems and cold fronts are typically followed by periods of southerly flowing winds that can last from one to three days. Bird migration is often more abundant during these periods, as birds are capitalizing on the generally suitable wind direction for fall migration (Richardson 1972). Consequently, nightly migration traffic rates can be expected to be variable and to peak when the best migration weather occurs. The variable nightly passage rates documented during the Fall 2004 radar surveys are consistent with this.

---

<sup>3</sup> The valley bottom site was not used in 2004. Rather, a site within the existing facility was chosen as it provided a better view of the entire landscape surrounding the project area. This location was not available to Martin, as those surveys were conducted prior to the construction of the existing Searsburg project.

Nightly mean passage rates ( $7 \pm 2$  to  $1121 \pm 207$  t/km/hr, with an overall mean of  $178 \pm 24$  t/km/hr) were generally similar to other radar surveys conducted locally and regionally. In a study in western New York, Cooper *et al.* (2004a) documented Fall 2003 passage rates between 10 and 905 t/km/hr with a mean passage rate of 235 t/km/hr. In another Fall 2003 study, Cooper *et al.* (2004b) documented nightly passage rates between 8 and 852 t/km/hr with a mean of 241 t/km/hr at Mount Storm, West Virginia. While there are limitations in comparing data between years, it appears that the general magnitude of migration observed in Searsburg during 2004 was similar to, though slightly lower than, similar radar surveys conducted recently in the Northeast and Mid-Atlantic States. The fact that the Searsburg results are lower could be expected, as it's more northerly location limits the size of the continental bird population that would be flying south, over the area, compared to sites further south.

Passage rates often peaked 3 hours after sunset, which is often typical of night time migration activity (Able 1970; Gauthreaux 1971; Richardson 1971, 1972). However, on many nights, and for the season as a whole, passage rates did not peak until 5 to 8 hours after sunset at all of the sites (Figure 10). The reason for a later nightly peak in abundance is not known.

Variation between passage rates detected at the different radar sites was observed. On slightly more than half of the nights surveyed, passage rates at the pair of sites being sampled on a particular night were similar (within approximately 40 t/km/hour of each other). This was particularly true for nights when significant migration activity was observed. The radar site at the Western Expansion Area provides the best reference for comparisons, as it was operated on every night of the survey. On nights when most of the highest passage rates were recorded at the Western Expansion Area, passage rates detected with the mobile radar were typically the highest detected at that site. For example, the two greatest passage rates detected at the Western Expansion Area were recorded on October 13<sup>th</sup> and September 23<sup>rd</sup>. These two nights correspond with the nights when the highest passage rate detected at the existing facility radar site (September 23<sup>rd</sup>) and low elevation site (October 13<sup>th</sup>) were recorded.

On the remaining nights, differences in passage rates were observed with no clear pattern as to why. The variation that was observed may simply be due to variation in the distribution of migrants in the air. That variation could potentially be caused by other factors, such as wind direction, wind speed, and migrant height.

### *Flight Direction*

Some research suggests that bird migration may be affected by landscape features, such as coastlines, large river valleys, and some northeastern mountain ranges. This has been documented for diurnally-migrating birds, such as raptors, but is not as well established for nocturnally migrating birds (Sielman *et al.* 1981, Bingman *et al.* 1982, Bruderer and Jenni 1990, Richardson 1998, Fortin *et al.* 1999, Williams *et al.* 2001, Diehl *et al.* 2003, Woodlot Alternatives, Inc. unpublished data).

The overall flight direction of targets documented in the project area was  $212^{\circ} \pm 55^{\circ}$ . Mean flight direction at each site varied from  $194^{\circ} \pm 48^{\circ}$  at the existing facility site to  $223^{\circ} \pm 56^{\circ}$  at the Western Expansion Area site. The mean flight directions that were observed were roughly parallel to the alignment of the ridgeline of the existing facility but perpendicular to the alignment of the ridgeline of the Western Expansion Area, indicating that avoidance of any specific areas, such as ridgelines, by migrants was not occurring.

### *Flight Height*

The altitude at which nocturnal migrants fly has been one of the least understood aspects of bird migration. Bellrose (1971) flew a small plane at night along altitudinal transects to visually document the occurrence and altitude of migrating songbirds. He found the majority of birds observed were between 150 m and 450 m above the ground level but on some nights the majority of birds observed were from 450 m to 762 m above the ground. Radar studies have largely confirmed those visual observations, with the majority of nocturnal bird migration appearing to occur less than 500 m to 700 m above the ground (Able 1970, Alerstam 1990, Gauthreaux 1991, Cooper and Ritchie 1995).

Studies at other proposed wind facilities in the Northeast are consistent with this as well. Cooper *et al.* (2004b) documented mean nightly flight altitudes at Mount Storm, West Virginia, between 214 m and 769 m, with a seasonal mean of 410 m. In western New York, Cooper *et al.* (2004a) documented a mean flight altitude of 532 m with a small percentage (4%) of targets flying less 125 m above the ground.

Flight heights documented in the Deerfield Wind Project area were generally similar to those of Cooper *et al.* (2004a, 2004b), with nightly flight altitudes varying from  $166 \pm 7$  m to  $896 \pm 72$  m and a mean of  $556 \pm 23$  m. The percentage of targets flying less than 100 m above the ground varied from 0.1 % at the existing facility site to 5 % at the Western Expansion Area site, with an overall seasonal average of 3%.

The mean flight height observed at the low elevation site was similar to the existing facility site and roughly 110 meters higher than the Western Expansion Area site. An interesting trend in the mean flight altitude of migrants above sea level was observed. Based on the elevation of each radar site (existing facility site, 876 m; Western Expansion Area site, 888 m; and low elevation site, 665 m) the mean flight altitude of migrants at the low elevation site was approximately 120 m lower than the Western Expansion Area site which, in turn, was approximately 100 m lower than the existing facility site. Consequently, this trend in flight altitudes slopes from the lowest (above sea level) migrants to the west and the highest migrants to the east (Figure 14). The reason for this trend is unknown, but could be due to the formation of suitable migration conditions above the ground and the flow of air across the landscape.

**LEGEND**

Standard Error <  Mean Flight Height

Mean Flight Height  $624\text{ m} \pm 24\text{ m}$  

Mean Flight Height  $503\text{ m} \pm 21\text{ m}$



Mean Flight Height  $611\text{ m} \pm 10\text{ m}$  

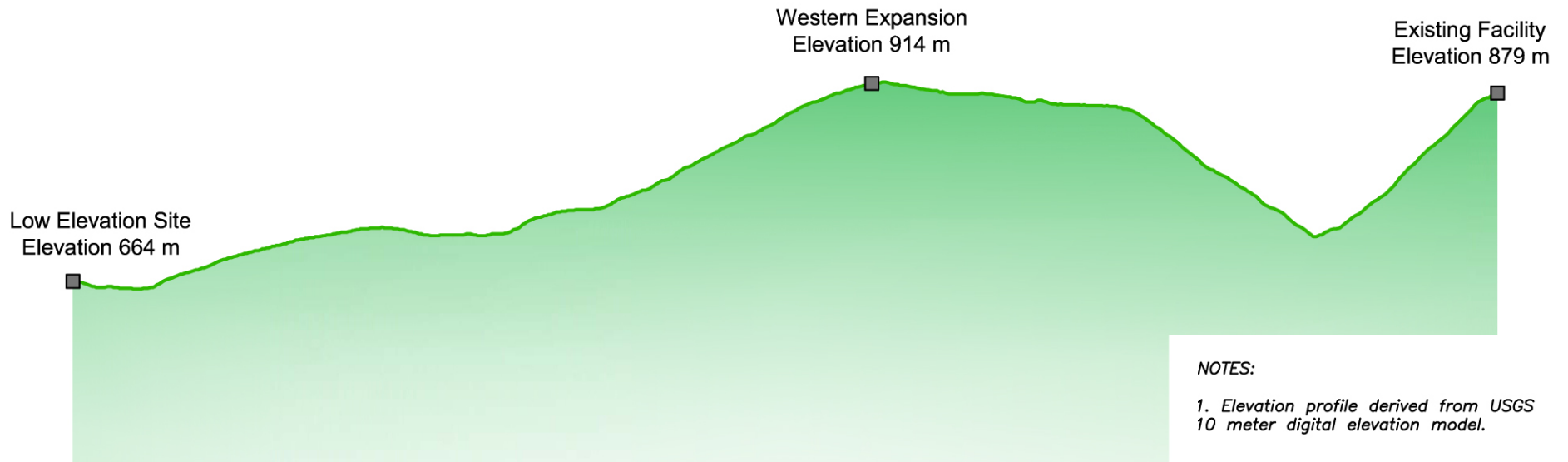

PREPARED BY:



DESIGN:	DATE: March 2005
DRAFT:	JOB NO: 104145
CHECKED:	SCALE: 1" = 600'
FILE NAME: profile_figure.dwg	

DRAWING NAME:

*Elevation Profile Between Radar Sites*

PROJECT:

*Searsburg Wind Project - Searsburg Vermont*

FIGURE NO.

14

## 5.0 Conclusions

The results of the field surveys indicate that fall raptor migration in the Deerfield Wind Project area is low relative to other sites in the region. Raptors observed passing near or through the project area flew at relatively high altitudes and only 9% of all birds observed were flying below the height of the proposed turbines' rotor sweep areas. Based on the flight characteristics of the raptors observed in the project area, it is likely that most migrating raptors would not come into close contact with the proposed project facilities. Additionally, observations of birds lifting up over the existing turbines demonstrate that these diurnally-migrating species have the potential to avoid turbines.

Radar surveys indicate that nighttime bird migration patterns are similar to patterns observed at other sites in the Northeast U.S. region. Migration activity varied throughout the season, which is probably largely attributable to weather patterns.

Flight direction for the entire fall season was to the southwest. Flight direction data indicate that nocturnal migrants are not avoiding the project area for any topographic-related reasons. Rather, migrants were observed flying both parallel and perpendicular to the ridgelines of the proposed project.

Flight altitude data strengthen the assumption that topography is not drastically affecting flight patterns of migrants over the project area. Flight altitudes were generally similar although there was a general trend for higher flight altitude (above sea level) at the east end of the project area and lower altitude at the west end. The vast majority of nocturnal migrants are flying at altitudes well above the turbine height of the proposed project, which reduces potential risk to migrants. Interestingly, the mean flight altitude observed above the low elevation site (1276 m above sea level) is still approximately 400 m above the highest elevations of the Western Expansion Area. This is still further evidence that topography in the project area does not appear to affect nighttime flight patterns and that the majority of the overall population of migrants flies at altitudes well above the proposed turbine heights.



## 6.0 Literature Cited

- Able, K.P. 1970. A radar study of the altitude of nocturnal passerine migration. *Bird-Banding* 41(4):282-290.
- Able, K.P. 1973. The role of weather variables and flight direction in determining the magnitude of nocturnal migration. *Ecology* 54(5):1031-1041.
- Alerstam, T. 1990. *Bird Migration*. Cambridge University Press, Cambridge, United Kingdom. 420 pp.
- Batschelet, E. 1965. *Statistical Methods for the Analysis of Problems in Animal Orientation and Certain Biological Rhythms*. AIBS Monograph. American Institute of Biological Sciences. Washington, DC. 57 pp.
- Bellrose, F. C. 1971. The distribution of nocturnal migration in the air space. *The Auk* 88:397-424.
- Bingman, V.P., K.P. Able, and P. Kerlinger. 1982. Wind drift, compensation, and the use of landmarks by nocturnal bird migrants. *Animal Behavior* 30:49-53.
- Bruderer, B., and L. Jenni. 1990. Migration across the Alps. Pages 61–77 *in* *Bird Migration: Physiology and Ecophysiology* (E. Gwinner, Ed.). Springer Verlag, Berlin.
- Capen and Coker 1994. Avian studies – Proposed GMP (Green Mountain Power Corporation's) wind turbine project Searsburg and Readsboro, Vermont, Summer 1994. Report for Green Mountain Power Corporation, Burlington, VT.
- Cooper, B.A., and R.J. Ritchie. 1995. The altitude of bird migration in east-central Alaska: a radar and visual study. *Journal of Field Ornithology* 66(4):590-608.
- Cooper, B.A., R.H. Day, R.J. Ritchie, and C.L. Cranor. 1991. An improved marine radar system for studies of bird migration. *Journal of Field Ornithology* 62:367-377.
- Cooper, B.A., A.A. Stickney, and T.J. Mabee. 2004a. A radar study of nocturnal bird migration at the proposed Chautauqua wind energy facility, New York, Fall 2003.
- Cooper, B.A., T. Mabee, and J. Plissner. 2004b. Radar study of nocturnal bird migration at the proposed Mount Storm wind power development, West Virginia, Fall 2003. *Appendix in: Baseline Avian studies Mount Storm wind power project, Grant County, West Virginia, final report April 2004*. Prepared for NedPower Mount Storm, LLC.

- Diehl, R., R. Larkin, and J. Black. 2003. Radar observations of bird migration over the Great Lakes. *The Auk* 120(2):278-290.
- Fortin, D., F. Liechti, and B. Bruderer. 1999. Variation in the nocturnal flight behaviour of migratory birds along the northwest coast of the Mediterranean Sea. *Ibis* 141:480-488.
- Gauthreaux, S.A., Jr. 1969. A Portable ceilometer technique for studying low-level nocturnal migration. *Bird-Banding* 40(4):309-320.
- Gauthreaux, S.A., Jr. 1971. A radar and direct visual study of passerine spring migration southern Louisiana. *The Auk* 88: 343-365.
- Gauthreaux, S.A., Jr. 1991. The flight behavior of migrating birds in changing wind fields: radar and visual analyses. *American Zoologist* 31:187-204.
- Gauthreaux, S.A., Jr., and K.P. Able. 1970. Wind and the direction of nocturnal songbird migration. *Nature* 228:476-477.
- Harmata, A., K. Podruzny, J. Zelenak, and M. Morrison. 1999. Using marine surveillance radar to study bird movements and impact assessment. *Wildlife Society Bulletin* 27(1):44-52.
- Hassler, S.S., R.R. Graber, and F.C. Bellrose. 1963. Fall migration and weather, a radar study. *The Wilson Bulletin* 75(1):56-77.
- Kerlinger, P. 1995. *How Birds Migrate*. Stackpole Books. Mechanicsburg, Pennsylvania. 228 pp.
- Kerlinger, P. 1997. A study of the nocturnal migration of songbirds at the Searsburg, Vermont, Wind Energy Facility: Spring 1997. Report prepared for Vermont Department of Public Service, National Renewable Energy Laboratory, Green Mountain Power Corporation and VERA. 14pp.
- Kerlinger, P. 1998. An assessment of the impacts of Green Mountain Power Corporation's Searsburg, Vermont, wind power facility on breeding and migrating birds. Report for National Renewable Energy Laboratory, Golden, CO.
- Lowery, G.H., Jr. 1951. A quantitative study of the nocturnal migration of birds. University of Kansas Publications, Museum of Natural History 3(2):361-472.
- Martin, N.L. 1993. Hawk migration at Searsburg, Vermont – 20 September to 28 October 1993. Report prepared for Green Mountain Power Corporation, Burlington, VT.

- Martin, N.L. 1994. Hawk migration at Searsburg, Vermont – 1 to 20 September 1994. Report prepared for Green Mountain Power Corporation, Burlington, VT.
- Richardson, W.J. 1971. Spring migration and weather in eastern Canada: a radar study. *American Birds*. 25: 684-690.
- Richardson, W.J. 1972. Autumn migration and weather in eastern Canada: a radar study. *American Birds* 26(1):10-16.
- Richardson, W.J. 1998. Bird migration and wind turbines: migration timing, flight behavior, and collision risk. Proceedings: National Avian-Wind Power Planning Meeting III, sponsored by Avian Workgroup of the National Wind Coordinating Committee, June 2000.
- Sielman, M., L. Sheriff, and T. Williams. 1981. Nocturnal Migration at Hawk Mountain, Pennsylvania. *American Birds* 35(6):906-909.
- Thompson, E.H. and E.R. Sorenson. 2000. *Wetland, Woodland, Wildland: A Guide to the Natural Communities of Vermont*. University Press of New England, Hanover, NH. 456pp.
- Williams, T.C., J.M. Williams, P.G. Williams, and P. Stokstad. 2001. Bird migration through a mountain pass studied with high resolution radar, ceilometers, and census. *The Auk* 118(2): 389-403.
- Zar, J.H. 1999. *Biostatistical Analysis*. Fourth Edition. Prentice Hall. Upper Saddle River, New Jersey.

## **Appendix A**

Raptor Survey Data Tables

A Fall 2004 Radar, Visual, and Acoustic Survey of Bird and Bat Migration  
Proposed Deerfield Wind/Searsburg Expansion Project

Appendix A Table 1. Summary of raptor migration surveys																																														
Species	9/2/2004		9/3/2004		9/14/2004		9/15/2004		9/21/2004		9/22/2004		9/23/2004		9/24/2004		10/1/2004		10/3/2004		10/6/2004		10/7/2004		10/8/2004		10/20/2004		10/21/2004		10/23/2004		10/24/2004		10/29/2004		10/30/2004		10/31/2004		Total at Existing Facility		Total at Western Expansion Area		Grand Total	
	Site*	E	W	E	W	W	E	W	E	W	E	W	E	W	E	W	E	W	E	W	E	W	E	W	E	W	E	W	E	W	E	W	E	Total	birds/hr	Total	birds/hr	Total	birds/hr							
Turkey Vulture			11	2	1			7	1	2			2			1																		21	0.35	6	0.11	27	0.23							
Osprey			4	1	1	1		2		1	1																						8	0.13	3	0.05	11	0.09								
Northern Harrier					1																												0	0.00	1	0.02	1	0.01								
Sharp-shinned Hawk			2		3	2	1			3	1		1	1		1		1															6	0.10	10	0.18	16	0.14								
Cooper's Hawk	2	1					1																										2	0.03	3	0.05	5	0.04								
Northern Goshawk										1																								0	0.00	1	0.02	1	0.01							
Red-shouldered Hawk										1																								0	0.00	1	0.02	1	0.01							
Broad-winged Hawk	2		48	603	3			11	4	58																							65	1.08	664	11.65	729	6.23								
Red-tailed Hawk		1				2	3			8			4	1	3	1																		9	0.15	14	0.25	23	0.20							
American Kestrel							2						2																					0	0.00	4	0.07	4	0.03							
Bald Eagle		1																																0	0.00	1	0.02	1	0.01							
Unid. Accipiter				2		1		1	3		1																							6	0.10	2	0.04	8	0.07							
Unid. Buteo	1		7	4	1		1	1	4	3	4	1			1																			18	0.30	11	0.19	29	0.25							
Unid. Falcon				1																														0	0.00	1	0.02	1	0.01							
Unid. Raptor			9	1		1		1		1	1					1																		12	0.20	3	0.05	15	0.13							
<b>Total:</b>	<b>5</b>	<b>3</b>	<b>81</b>	<b>614</b>	<b>10</b>	<b>7</b>	<b>8</b>	<b>23</b>	<b>12</b>	<b>78</b>	<b>8</b>	<b>3</b>	<b>7</b>	<b>2</b>	<b>4</b>	<b>5</b>	<b>0</b>	<b>2</b>	<b>0</b>	<b>0</b>	<b>0</b>	<b>0</b>	<b>0</b>	<b>0</b>	<b>0</b>	<b>0</b>	<b>0</b>	<b>0</b>	<b>0</b>	<b>0</b>	<b>0</b>	<b>147</b>	<b>2.45</b>	<b>725</b>	<b>12.72</b>	<b>872</b>	<b>7.45</b>									

A Fall 2004 Radar, Visual, and Acoustic Survey of Bird and Bat Migration  
Proposed Deerfield Wind/Searsburg Expansion Project

---

<b>Appendix A Table 2. Summary of hourly raptor observations.</b>						
<b>Species</b>	<b>9:00-10:00</b>	<b>10:00-11:00</b>	<b>11:00-12:00</b>	<b>12:00-1:00</b>	<b>1:00-2:00</b>	<b>2:00-3:00</b>
Turkey Vulture	0	1	1	7	4	14
Osprey	0	1	2	2	4	2
Northern Harrier	0	0	0	0	0	1
Sharp-shinned Hawk	0	3	2	2	6	3
Cooper's Hawk	2	0	1	0	2	0
Northern Goshawk	0	0	1	0	0	0
Red-shouldered Hawk	1	0	0	0	0	0
Broad-winged Hawk	1	124	203	118	118	165
Rough-legged Hawk	0	0	0	0	0	0
Red-tailed Hawk	1	4	2	3	7	6
American Kestrel	1	2	1	0	0	0
Merlin	0	0	0	0	0	0
Peregrine Falcon	0	0	0	0	0	0
Bald Eagle	0	1	0	0	0	0
Unid. Accipiter	0	2	3	0	2	1
Unid. Buteo	0	2	4	7	12	4
Unid. Falcon	0	0	0	0	1	0
Unid. Eagle	0	0	0	0	0	0
Unid. Raptor	0	1	3	3	6	2
<b>Total</b>	<b>6</b>	<b>141</b>	<b>223</b>	<b>142</b>	<b>162</b>	<b>198</b>

A Fall 2004 Radar, Visual, and Acoustic Survey of Bird and Bat Migration  
Proposed Deerfield Wind/Searsburg Expansion Project

<b>Appendix A Table 3.</b> Summary of raptor flight heights relative to the height of proposed wind turbines.								
<b>Species</b>	<b>Existing Facility</b>				<b>Western Expansion Area</b>			
	<b># &lt; 100 m</b>	<b>% &lt; 100 m</b>	<b># &gt; 100 m</b>	<b>% &gt; 100 m</b>	<b># &lt; 100 m</b>	<b>% &lt; 100 m</b>	<b># &gt; 100 m</b>	<b>% &gt; 100m</b>
Turkey Vulture	1	5%	20	95%	2	33%	4	67%
Osprey	1	13%	7	88%	1	33%	2	67%
Northern Harrier					0	0%	1	100%
Sharp-shinned Hawk	3	50%	3	50%	5	50%	5	50%
Cooper's Hawk	2	100%	0	0%	2	67%	1	33%
Northern Goshawk					1	100%	0	0%
Unid. Accipiter	3	50%	3	50%	1	50%	1	0%
Red-shouldered Hawk					1	100%	0	0%
Broad-winged Hawk	1	2%	64	98%	30	5%	634	95%
Red-tailed Hawk	2	22%	7	78%	7	50%	7	50%
Unid. Buteo	3	17%	15	83%	2	18%	9	82%
American Kestrel					4	100%	0	0%
Unid. Falcon					0	0%	1	100%
Bald Eagle					0	0%	1	100%
Unid. Raptor	3	25%	9	75%	0	0%	3	100%
<b>Total</b>	<b>19</b>	<b>13%</b>	<b>128</b>	<b>87%</b>	<b>56</b>	<b>8%</b>	<b>669</b>	<b>92%</b>
Combined Total: 77 birds (9%) below 100 m and 797 birds (91%) above 100 m.								

A Fall 2004 Radar, Visual, and Acoustic Survey of Bird and Bat Migration  
 Proposed Deerfield Wind/Searsburg Expansion Project

**Appendix A Table 4.** Summary of Fall 2004 raptor surveys at regional hawk count locations.

Location*	Observation Hours	TV	OS	BE	NH	SS	CH	NG	RS	BW	RT	GE	AK	ML	PG	UR	UB	UA	UF	TOTAL	BIRDS/HOUR
Putney Mountain, VT	139	27	102	21	20	488	29	6	7	4020	19	1	103	6	10	6	0	0	0	4865	35.0
Pack Monadnock, NH	28.5	3	39	14	4	77	6	0	1	1832	0	1	15	7	1	0	0	0	0	2000	70.2
Mount Wachusett, MA	51.5	0	117	11	8	172	24	3	2	2978	0	0	45	1	1	71	0	0	0	3433	66.7
Barre Falls, MA	244.5	271	201	38	41	961	94	3	44	3609	136	3	171	37	9	36	0	0	0	5654	23.1
Little River Lookout, MA	152.75	109	65	30	7	252	14	2	6	1121	65	0	148	9	8	18	0	0	0	1854	12.1
Searsburg, VT	117	27	11	1	1	16	5	1	1	729	23	0	4	0	0	15	8	29	1	872	7.5

\* data obtained from HMANA website

**Abbreviation Key:**

- |                          |                             |
|--------------------------|-----------------------------|
| TV - Turkey Vulture      | RT - Red-tailed Hawk        |
| OS - Osprey              | GE - Golden Eagle           |
| BE - Bald Eagle          | AK - American Kestrel       |
| NH - Northern Harrier    | ML - Merlin                 |
| SS- Sharp-shinned Hawk   | PG - Peregrine Falcon       |
| CH - Cooper's Hawk       | UR - unidentified Raptor    |
| NG - Northern Goshawk    | UB - unidentified Buteo     |
| RS - Red-shouldered Hawk | UA - unidentified Accipiter |
| BW - Broad-winged        | UF - unidentified Falcon    |





## **Appendix B**

Radar Survey Data Tables

A Fall 2004 Radar, Visual, and Acoustic Survey of Bird and Bat Migration  
Proposed Deerfield Wind/Searsburg Expansion Project

Appendix B Table 1. Summary of Radar Data Results.									
Night of	Mean Nightly Passage Rate (t/km/hr)			Mean Flight Direction (°)			Mean Flight Height (m)		
	Existing	Western	Low	Existing	Western	Low	Existing	Western	Low
Sep 16	--	265 ± 28	--	--	75 ± 42	--	--	435 ± 4	--
Sep 18	409 ± 67	227 ± 31	--	194 ± 27	212 ± 19	--	778 ± 43	636 ± 34	--
Sep 19	387 ± 57	244 ± 21	--	211 ± 27	223 ± 21	--	772 ± 35	644 ± 62	--
Sep 20	205 ± 24	112 ± 14	--	118 ± 54	134 ± 54	--	640 ± 84	581 ± 69	--
Sep 21	195 ± 30	113 ± 16	--	107 ± 39	107 ± 44	--	456 ± 34	476 ± 39	--
Sep 22	262 ± 31	239 ± 25	--	172 ± 46	200 ± 43	--	796 ± 78	667 ± 51	--
Sep 23	519 ± 56	513 ± 37	--	221 ± 22	234 ± 23	--	812 ± 25	670 ± 35	--
Sep 24	--	186 ± 30	227 ± 30	--	81 ± 92	299 ± 100	--	662 ± 54	713 ± 45
Sep 25	--	78 ± 29	119 ± 39	--	152 ± 42	190 ± 73	--	352 ± 23	510 ± 44
Oct 8	--	124 ± 20	94 ± 9	--	23 ± 39	265 ± 99	--	450 ± 19	467 ± 28
Oct 9	31 ± 7	259 ± 50	--	147 ± 44	149 ± 54	--	453 ± 26	348 ± 13	--
Oct 10	--	174 ± 43	143 ± 18	--	209 ± 28	216 ± 42	--	611 ± 58	705 ± 49
Oct 11	46 ± 8	86 ± 18	--	193 ± 24	196 ± 25	--	789 ± 26	610 ± 38	--
Oct 12	155 ± 25	395 ± 37	--	180 ± 23	190 ± 27	--	896 ± 72	673 ± 19	--
Oct 13	--	1121 ± 207	404 ± 79	--	257 ± 24	229 ± 36	--	695 ± 39	749 ± 48
Oct 14	--	54 ± 4	58 ± 12	--	280 ± 25	209 ± 50	--	166 ± 7	435 ± 27
Oct 16	--	40 ± 7	81 ± 11	--	133 ± 42	186 ± 46	--	209 ± 32	366 ± 22
Oct 17	7 ± 2	21 ± 6	--	86 ± 34	123 ± 34	--	n/a	333 ± 197	--
Oct 18	--	175 ± 48	325 ± 91	--	189 ± 27	208 ± 29	--	576 ± 114	752 ± 22
Oct 20	--	286 ± 34	183 ± 22	--	246 ± 28	204 ± 34	--	585 ± 31	627 ± 27
Oct 21	104 ± 25	136 ± 25	--	233 ± 24	242 ± 25	--	410 ± 42	310 ± 57	--
Oct 22	--	193 ± 31	103 ± 15	--	236 ± 29	189 ± 37	--	306 ± 39	471 ± 42
Oct 23	--	64 ± 9	89 ± 11	--	250 ± 29	200 ± 36	--	347 ± 47	491 ± 43
Oct 24	9 ± 6	8 ± 2	--	247 ± 48	266 ± 87	--	592 ± 105	470 ± 69	--
Oct 25	--	90 ± 15	75 ± 7	--	199 ± 39	197 ± 52	--	718 ± 37	832 ± 48
Oct 26	105 ± 15	57 ± 6	--	206 ± 31	215 ± 32	--	645 ± 53	495 ± 33	--
Oct 27	--	122 ± 15	49 ± 5	--	212 ± 30	193 ± 43	--	646 ± 51	830 ± 39
Oct 29	10 ± 3	20 ± 5	--	256 ± 76	287 ± 63	--	484 ± 42	408 ± 43	--
<b>Season:</b>	<b>175 ± 44</b>	<b>193 ± 41</b>	<b>150 ± 30</b>	<b>194 ± 48</b>	<b>223 ± 56</b>	<b>214 ± 55</b>	<b>624 ± 24</b>	<b>503 ± 21</b>	<b>611 ± 10</b>

\* Reported data includes the calculated mean and, for passage rates and flight heights, the Standard Error. For flight direction, the mean and the Circular Standard Deviation are reported.

A Fall 2004 Radar, Visual, and Acoustic Survey of Bird and Bat Migration  
Proposed Deerfield Wind/Searsburg Expansion Project

<b>Appendix B Table 2. Summary of passage rates by hour, night, and for the entire season - Searsburg Existing Facility.</b>															
<b>Night of</b>	<b>Passage Rate (targets/km/hr)</b>													<b>Entire Night</b>	
	<i>1</i>	<i>2</i>	<i>3</i>	<i>4</i>	<i>5</i>	<i>6</i>	<i>7</i>	<i>8</i>	<i>9</i>	<i>10</i>	<i>11</i>	<i>12</i>	<i>13</i>	<b>Mean</b>	<b>SE</b>
Sep 18	251	634	649	679	703	571	462	264	286	189	94	129	--	409	67
Sep 19	171	540	504	499	686	630	461	375	259	287	148	86	--	387	57
Sep 20	147	283	296	304	272	257	205	240	167	88	90	107	--	205	24
Sep 21	136	296	336	294	244	300	123	71	75	146	129	--	--	195	30
Sep 22	202	298	302	272	340	335	382	375	116	136	120	--	--	262	31
Sep 23	216	512	498	614	759	673	624	669	680	538	236	214	--	519	56
Oct 9	11	11	9	11	7	19	48	64	54	69	54	21	--	31	7
Oct 11	9	20	29	62	50	34	21	36	105	105	55	32	43	46	8
Oct 12	48	146	257	231	274	209	60	227	259	126	45	68	64	155	25
Oct 17	2	5	2	6	16	6	0	16	5	--	--	--	--	7	2
Oct 21	17	66	163	191	251	279	101	88	96	54	28	19	2	104	25
Oct 24	1	21	24	73	0	0	0	0	0	0	2	0	0	9	6
Oct 26	40	105	92	141	150	174	169	167	110	72	93	9	38	105	15
Oct 29	1	12	16	34	15	4	6	14	9	2	0	--	--	10	3
<b>Entire Season</b>	90	211	227	244	269	249	190	186	159	139	84	68	29	175	44

-- indicates no data available for that hour period

A Fall 2004 Radar, Visual, and Acoustic Survey of Bird and Bat Migration  
 Proposed Deerfield Wind/Searsburg Expansion Project

<b>Appendix B Table 3. Summary of passage rates by hour, night, and for the entire season - Searsburg Western Expansion Site.</b>															
<b>Night of</b>	<b>Passage Rate (targets/km/hr)</b>													<b>Entire Night</b>	
	<b>1</b>	<b>2</b>	<b>3</b>	<b>4</b>	<b>5</b>	<b>6</b>	<b>7</b>	<b>8</b>	<b>9</b>	<b>10</b>	<b>11</b>	<b>12</b>	<b>13</b>	<b>Mean</b>	<b>SE</b>
Sep 16	321	321	281	227	176	--	--	--	--	--	--	--	--	265	28
Sep 18	118	259	356	331	319	343	161	240	193	92	88	--	--	227	31
Sep 19	72	304	298	272	311	246	285	264	251	201	180	--	--	244	21
Sep 20	107	146	171	137	178	159	64	81	75	47	66	--	--	112	14
Sep 21	127	181	176	165		84	109	60	56	56	116	--	--	113	16
Sep 22	91	159	204	242	304	311	300	386	214	229	184	--	--	239	25
Sep 23	309	499	614	384	468	438	658	704	636	491	444	--	--	513	37
Sep 24	76	197	249	287	321	270	193	86	--	62	118	--	--	186	30
Sep 25	21	21	55	144	150	--	--	--	--	--	--	--	--	78	29
Oct 8	--	--	234	255	144	131	107	114	84	84	60	62	86	124	20
Oct 9	64	111	126	131	107	264	161	416	538	613	437	223	171	259	50
Oct 10	70	339	424		401	304	144	81	45	60	32	46	143	174	43
Oct 11	6	30	92	103	47	36	11	24	120	219	163	126	143	86	18
Oct 12	135	362	422	519	506	495	514	464	375	276	279	--	--	395	37
Oct 13	60	169	409	444	791	1336	1841	1817	2096	1776	1476	1236	--	1121	207
Oct 14	--	--	49	58	--	--	--	--	--	--	--	--	--	54	4
Oct 16	5	13	11	16	28	61	90	58	24	79	37	45	51	40	7
Oct 17	3	0	4	17	21	34	47	43	36	6	--	--	--	21	6
Oct 18	0	75	167	231	298	279	--	--	--	--	--	--	--	175	48
Oct 20	36	298	431	549	386	287	286	238	234	251	221	234	265	286	34
Oct 21	25	86	163	240	249	261	246	180	90	74	48	60	43	136	25
Oct 22	23	216	238	291	351	266	300	305	185	116	52	79	86	193	31
Oct 23	21	72	114	109	90	75	81	70	36	26	15	55	69	64	9
Oct 24	4	2	4	4	--	4	--	--	--	10	8	21	16	8	2
Oct 25	0	214	90	54	60	84	99	139	126	103	107	51	48	90	15
Oct 26	20	13	60	67	79	54	66	90	66	81	55	48	39	57	6
Oct 27	11	60	98	114	169	167	133	156	135	129	169	--	--	122	15
Oct 29	0	2	21	34	49	30	21	30	30	6	0	--	--	20	5
<b>Entire Season</b>	66	160	199	201	240	241	257	263	257	212	189	176	97	193	41

-- indicates no data available for that hour period

A Fall 2004 Radar, Visual, and Acoustic Survey of Bird and Bat Migration  
 Proposed Deerfield Wind/Searsburg Expansion Project

---

<b>Appendix B Table 4. Summary of passage rates by hour, night, and for the entire season - Searsburg Low Elevation Site.</b>															
<b>Night of</b>	<b>Passage Rate (targets/km/hr)</b>													<b>Entire Night</b>	
	<i>1</i>	<i>2</i>	<i>3</i>	<i>4</i>	<i>5</i>	<i>6</i>	<i>7</i>	<i>8</i>	<i>9</i>	<i>10</i>	<i>11</i>	<i>12</i>	<i>13</i>	<b>Mean</b>	<b>SE</b>
Sep 24	184	200	414	407	314	221	200	236	164	164	171	50	--	227	30
Sep 25	71	43	69	157	257	--	--	--	--	--	--	--	--	119	39
Oct 8	75	114	143	150	121	114	100	64	50	50	86	93	64	94	9
Oct 10	36	200	250	150	214	157	186	100	129	43	171	86	143	143	18
Oct 13	43	86	136	157	236	243	379	650	814	921	564	593	436	404	79
Oct 14	--	68	--	71	71	21	--	--	--	--	--	--	--	58	12
Oct 16	36	--	--	60	93	79	93	164	71	71	50	93	--	81	11
Oct 18	64	143	321	550	629	243	--	--	--	--	--	--	--	325	91
Oct 20	179	329	329	179	207	129	136	221	129	179	186	150	29	183	22
Oct 22	50	86	129	143	143	121	221	100	79	79	50	36	--	103	15
Oct 23	93	186	121	118	100	93	79	100	57	57	57	64	29	89	11
Oct 25	21	64	71	71	43	93	100	107	100	100	86	60	64	75	7
Oct 27	39	21	54	36	57	64	--	--	43	71	54	--	--	49	5
<b>Entire Season</b>	74	128	185	173	191	132	166	194	164	174	148	136	127	150	30

-- indicates no data available for that hour period

A Fall 2004 Radar, Visual, and Acoustic Survey of Bird and Bat Migration  
Proposed Deerfield Wind/Searsburg Expansion Project

---

<b>Appendix B Table 5.</b> Percentages of Birds Flying above or below 100 meters for all sites.						
<b>Night of</b>	<b>Existing Facility</b>		<b>Western Expansion</b>		<b>Low Elevation Site</b>	
	<b>% &lt; 100m</b>	<b>% &gt; 100m</b>	<b>% &lt; 100m</b>	<b>% &gt; 100m</b>	<b>% &lt; 100m</b>	<b>% &gt; 100m</b>
Sep 16	--	--	5.0	95.0	--	--
Sep 18	0.0	100.0	1.0	99.0	--	--
Sep 19	0.0	100.0	2.0	98.0	--	--
Sep 20	0.0	100.0	2.0	98.0	--	--
Sep 21	0.0	100.0	8.0	92.0	--	--
Sep 22	0.0	100.0	4.0	96.0	--	--
Sep 23	0.2	99.8	3.0	97.0	--	--
Sep 24	--	--	4.0	96.0	0.4	99.6
Sep 25	--	--	8.0	92.0	0.0	100.0
Oct 8	--	--	9.0	91.0	0.0	100.0
Oct 9	0.0	100.0	10.0	90.0	--	--
Oct 10	--	--	10.0	90.0	0.0	100.0
Oct 11	0.0	100.0	6.0	94.0	--	--
Oct 12	0.0	100.0	3.0	97.0	--	--
Oct 13	--	--	6.0	94.0	0.1	99.9
Oct 14	--	--	40.0	60.0	0.0	100.0
Oct 16	--	--	22.0	78.0	0.0	100.0
Oct 17	0.0	100.0	24.0	76.0	--	--
Oct 18	--	--	3.0	97.0	0.0	100.0
Oct 20	--	--	6.0	94.0	0.0	100.0
Oct 21	0.9	99.1	20.0	80.0	--	--
Oct 22	--	--	15.0	85.0	0.0	100.0
Oct 23	--	--	19.0	81.0	0.0	100.0
Oct 24	0.0	100.0	16.0	84.0	--	--
Oct 25	--	--	3.0	97.0	0.0	100.0
Oct 26	0.0	100.0	4.0	96.0	--	--
Oct 27	--	--	3.0	97.0	0.0	100.0
Oct 29	0.0	100.0	10.0	90.0	--	--
<b>Entire Season</b>	0.1	99.9	5.0	95.0	0.2	99.8

A Fall 2004 Radar, Visual, and Acoustic Survey of Bird and Bat Migration  
Proposed Deerfield Wind/Searsburg Expansion Project

<b>Appendix B Table 6. Summary of ceilometer (and Moonwatching) observations for all sites</b>									
Night of	Number of Observation Periods			Number of Birds Observed			Number of Bats Observed		
	Existing	Western	Low	Existing	Western	Low	Existing	Western	Low
Sep 16	--	4	--	--	0	--	--	0	--
Sep 18	11	9	--	0	0	--	0	0	--
Sep 19	11	11	--	0	0	--	0	0	--
Sep 20	11	11	--	0	3	--	0	0	--
Sep 21	9	10	--	0	1	--	0	0	--
Sep 22	11	8	--	0	1	--	0	2	--
Sep 23	11	10	--	0	1	--	0	0	--
Sep 24	--	6	9	--	0	0	--	0	0
Sep 25	--	4	5	--	0	0	--	0	0
Oct 8	--	10	11	--	0	0	--	0	0
Oct 9	10	12	--	0	0	--	0	0	--
Oct 10	--	10	11	--	0	1	--	0	0
Oct 11	10	12	--	0	0	--	0	0	--
Oct 12	9	10	--	0	1	--	0	0	--
Oct 13	--	9	10	--	1	0	--	0	0
Oct 14	--	11	5	--	0	0	--	0	0
Oct 16	--	11	10	--	0	0	--	0	0
Oct 17	8	9	--	0	0	--	0	0	--
Oct 18	--	6	5	--	0	0	--	0	0
Oct 20	--	11	9	--	0	1	--	0	0
Oct 21	12	11	--	0	0	--	0	0	--
Oct 22	--	11	11	--	0	0	--	0	0
Oct 23	--	10	8	--	0	0	--	0	0
Oct 24	10	10	--	0	0	--	0	0	--
Oct 25	--	4	2	--	0	0	--	0	0
Oct 26	12	10	--	0	0		0	0	--
Oct 27	--	6	5	--	0	0	--	0	0
Oct 29	10	0	--	0	0	--	0	0	--
<b>Total</b>	<b>145</b>	<b>246</b>	<b>101</b>	<b>0</b>	<b>8</b>	<b>2</b>	<b>0</b>	<b>2</b>	<b>0</b>

## **Appendix C**

Nightly Mean Flight Direction Histograms



Searsburg Existing - September 18, 2004

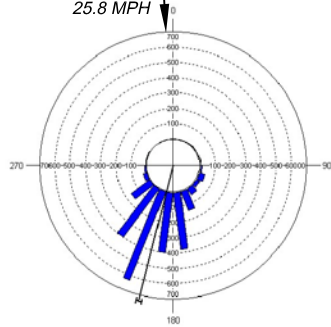

409 TPH

Searsburg Existing - September 19, 2004

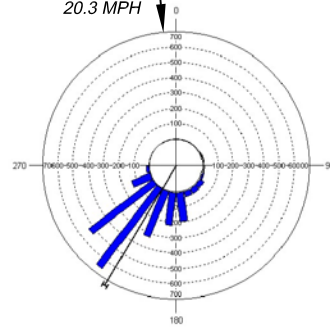

387 TPH

Searsburg Existing - September 20, 2004

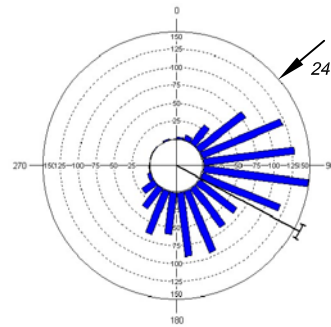

205 TPH

Searsburg Existing - September 21, 2004

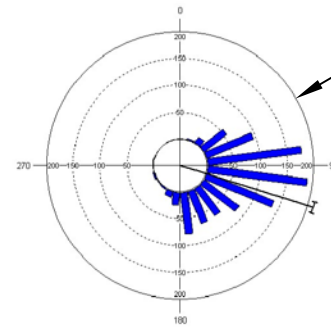

195 TPH

Searsburg Existing - September 22, 2004

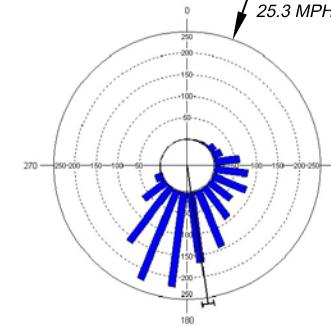

262 TPH

Searsburg Existing - September 23, 2004

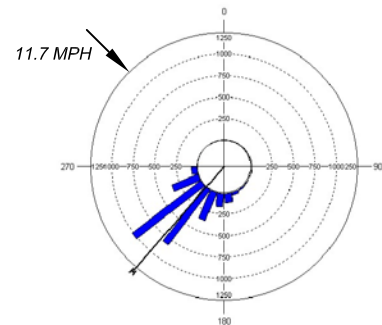

519 TPH

Searsburg Existing - October 9, 2004

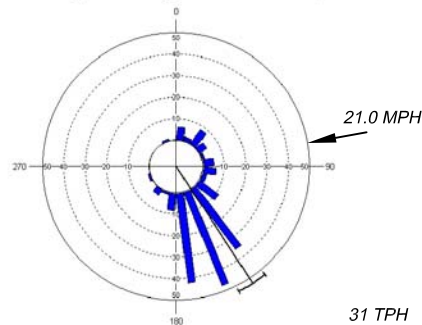

31 TPH

Searsburg Existing - October 11, 2004

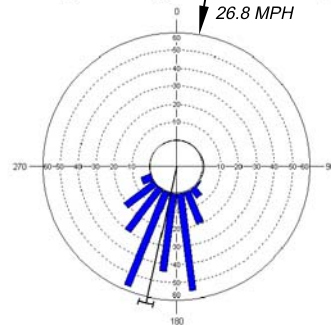

46 TPH

Searsburg Existing - October 12, 2004

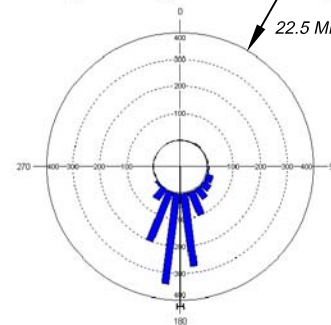

155 TPH

Searsburg Existing - October 17, 2004

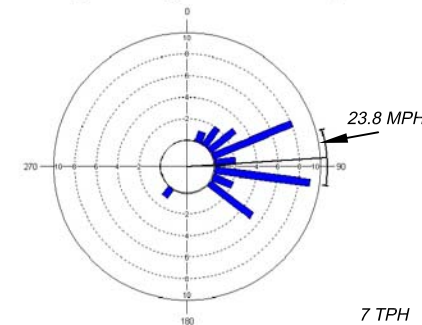

7 TPH

Searsburg Existing - October 21, 2004

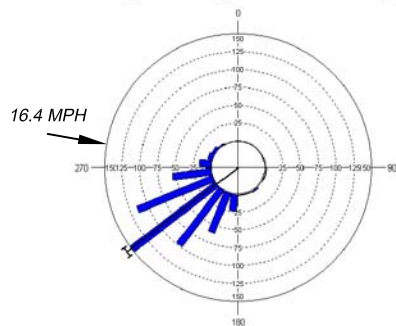

104 TPH

Searsburg Existing - October 24, 2004

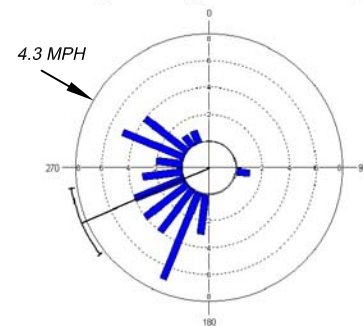

9 TPH

Searsburg Existing - October 26, 2004

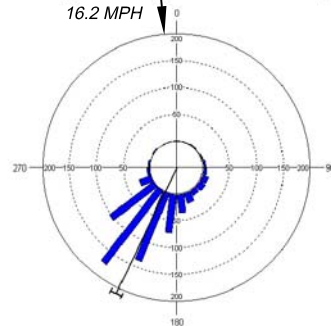

105 TPH

Searsburg Existing - October 29, 2004

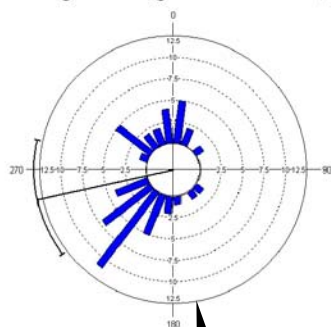

10 TPH

Entire Season - Searsburg Existing

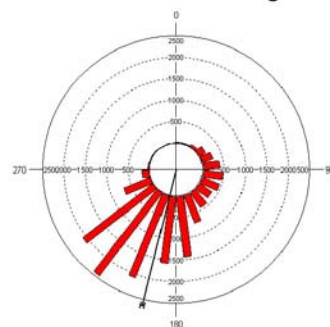

Entire Season - All Sites

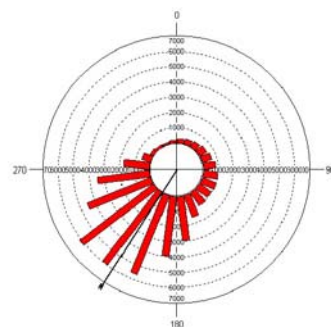

**RADAR DATA ROSE LEGEND**

Observation Location & Period

Searsburg Existing - October 21, 2004

Mean Wind Direction and Speed (Miles per Hour)

16.4 MPH

Number of Targets  
Histogram scale varies from night to night.

Mean Flight Direction

95% Confidence Interval

Mean Hourly Traffic Rate (Targets per Kilometer per Hour)

288 TPH

Data rose shows bird targets in directions of 20° increments.

NO.	REVISIONS	DATE

SHEET TITLE: Appendix C - Nightly Mean Flight Direction Existing Facility

SCALE: N/A

DATE: January 2005

PROJECT: Searsburg Avian Studies

ADDRESS: Searsburg Vermont

PREPARED BY:  WOODLOT ALTERNATIVES, INC. ENVIRONMENTAL CONSULTANTS

nightly\_traffic.dwg



Searsburg West - September 16, 2004

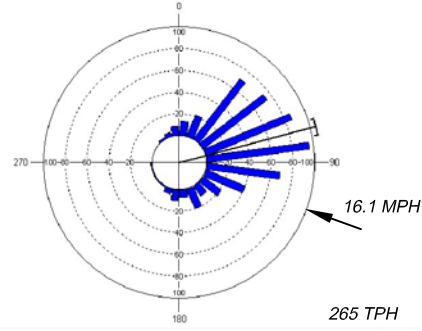

Searsburg West - September 18, 2004

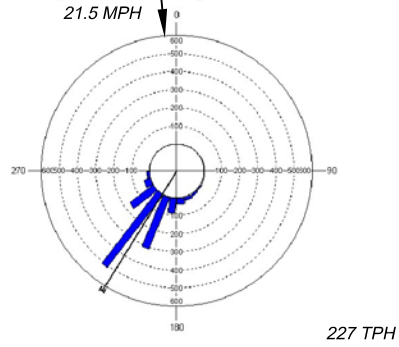

Searsburg West - September 19, 2004

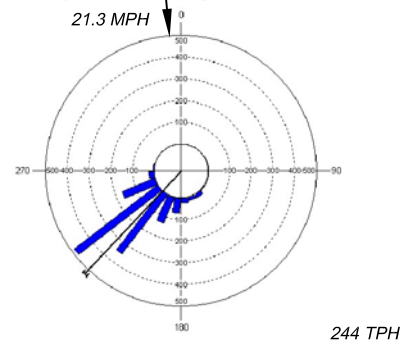

Searsburg West - September 20, 2004

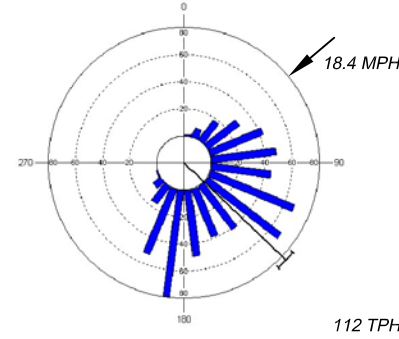

Searsburg West - September 21, 2004

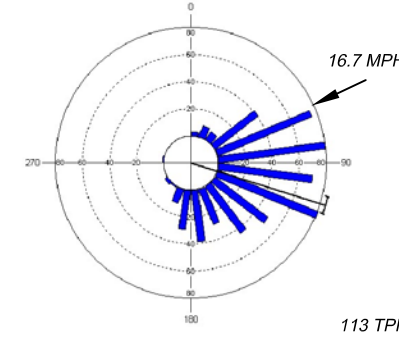

Searsburg West - September 22, 2004

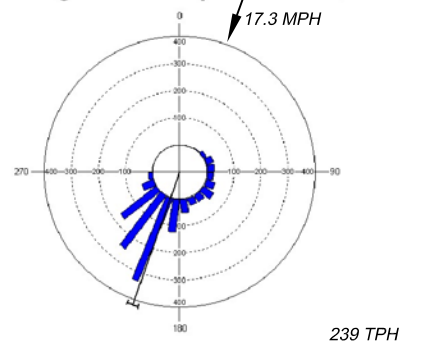

Searsburg West - September 23, 2004

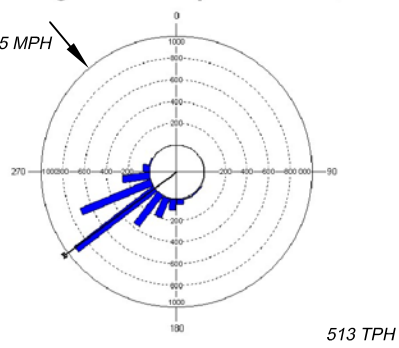

Searsburg West - September 24, 2004

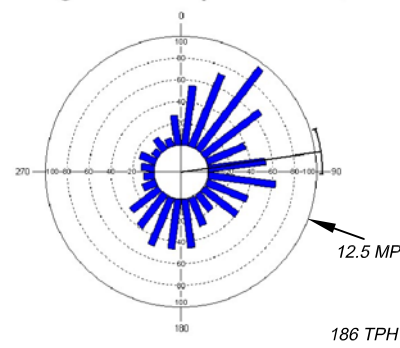

Searsburg West - September 25, 2004

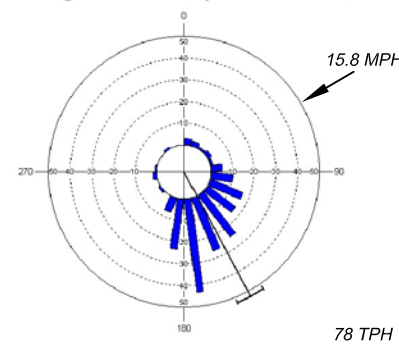

Searsburg West - October 8, 2004

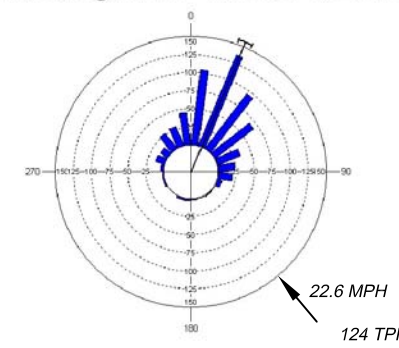

Searsburg West - October 9, 2004

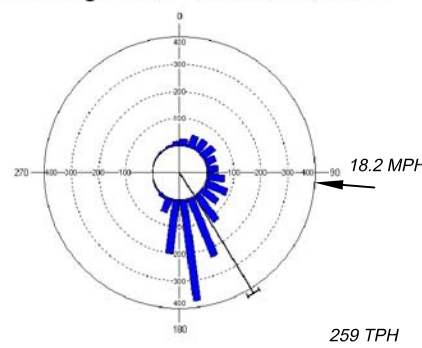

Searsburg West - October 10, 2004

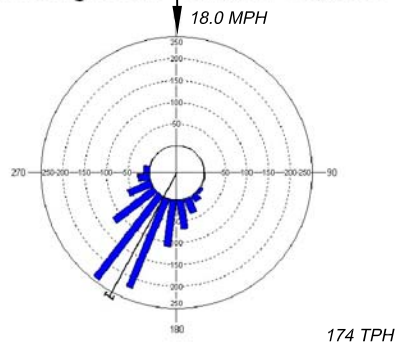

Searsburg West - October 11, 2004

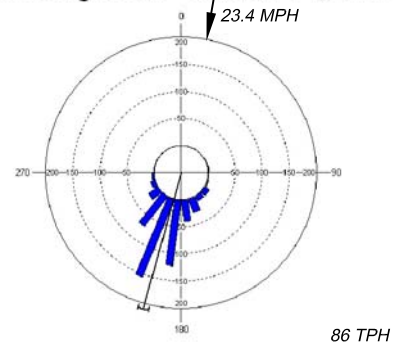

Searsburg West - October 12, 2004

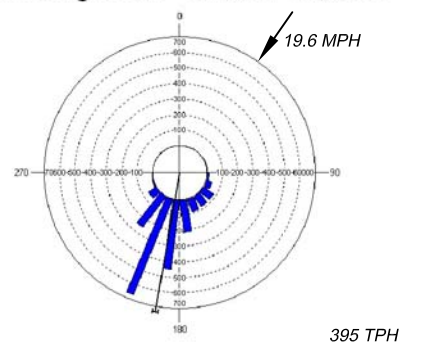

Entire Season - Searsburg West

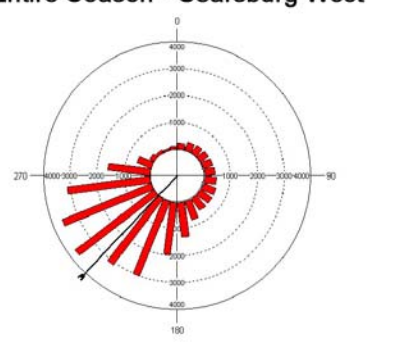

Entire Season - All Sites

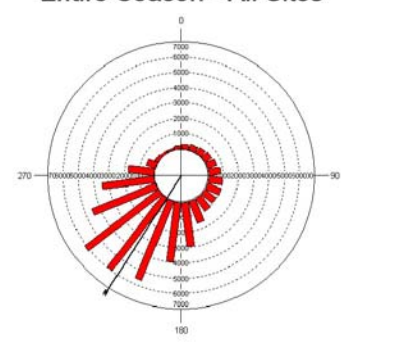

**RADAR DATA ROSE LEGEND**

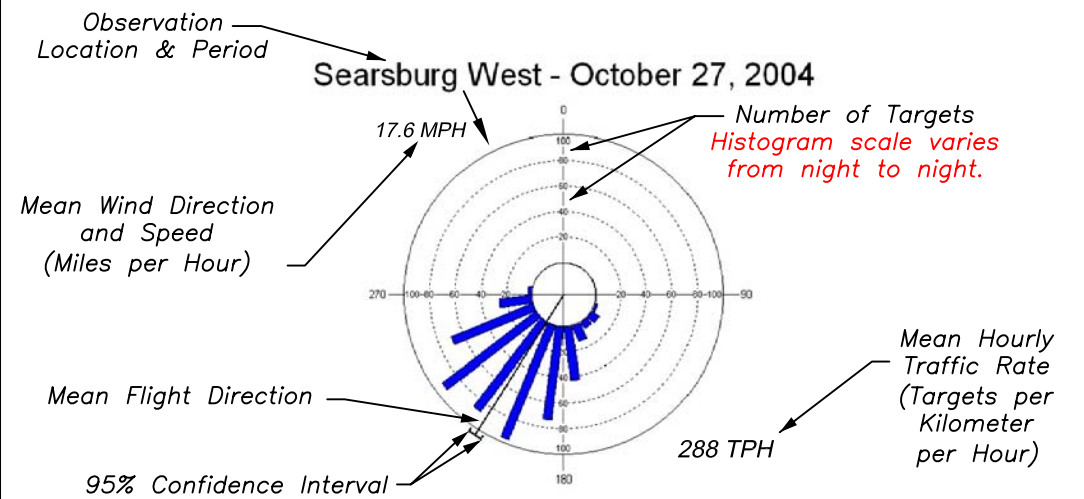

Data rose shows bird targets in directions of 20° increments.

NO.	REVISIONS	DATE

SHEET TITLE: Appendix C - Nightly Mean Flight Direction  
Western Expansion Area

SCALE: N/A

DATE: January 2005

PROJECT: Searsburg Avian Studies

ADDRESS: Searsburg Vermont



PROJ. NO. 104145

FIGURE NO.

Searsburg West - October 13, 2004

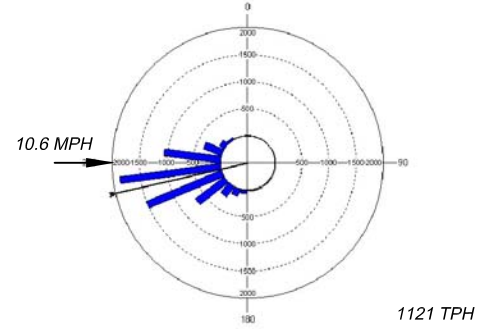

Searsburg West - October 14, 2004

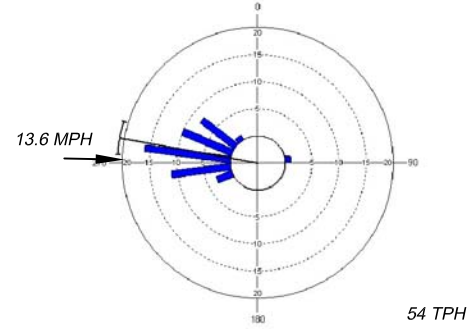

Searsburg West - October 16, 2004

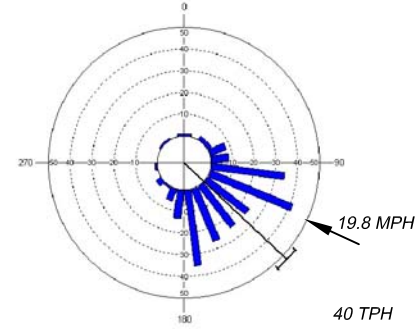

Searsburg West - October 17, 2004

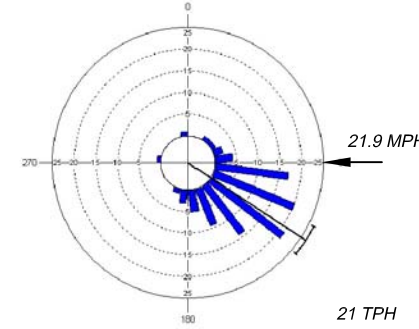

Searsburg West - October 18, 2004

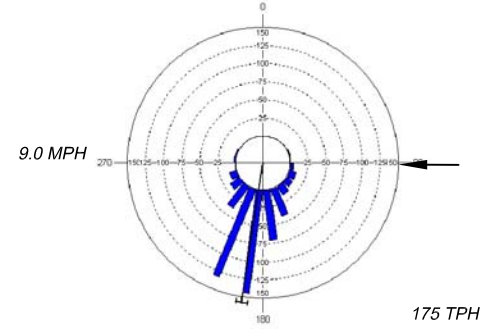

Searsburg West - October 20, 2004

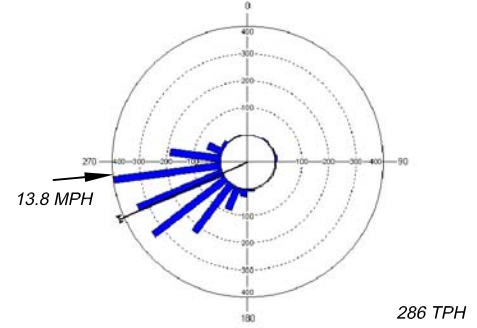

Searsburg West - October 21, 2004

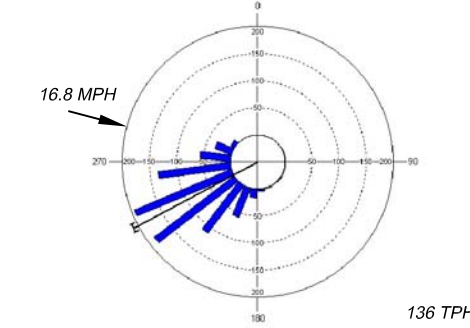

Searsburg West - October 22, 2004

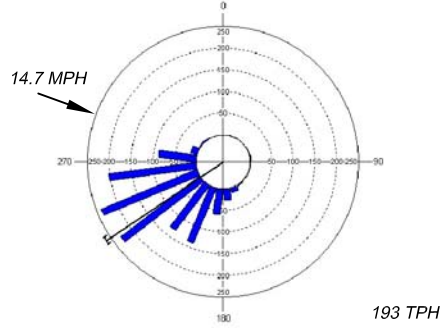

Searsburg West - October 23, 2004

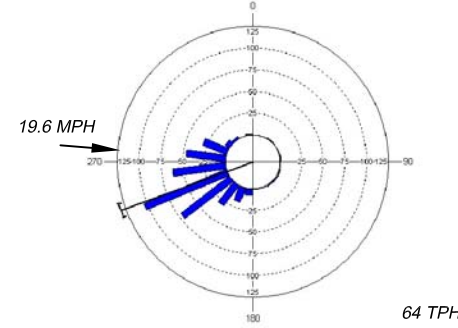

Searsburg West - October 24, 2004

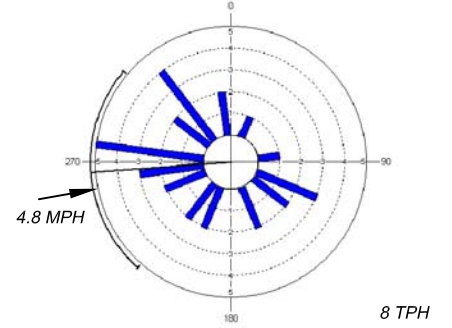

Searsburg West - October 25, 2004

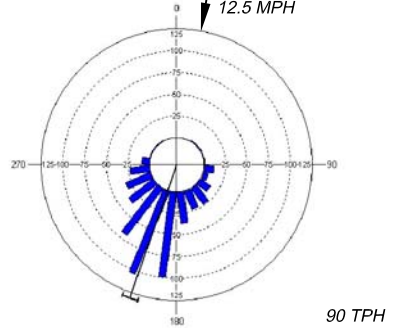

Searsburg West - October 26, 2004

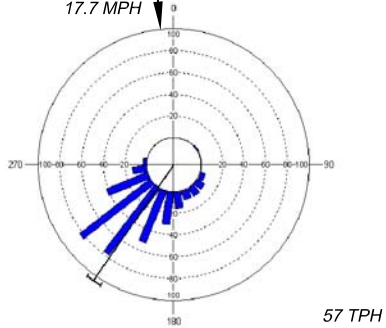

Searsburg West - October 27, 2004

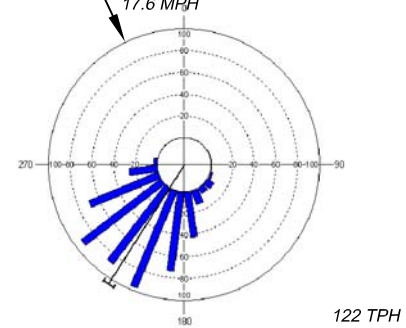

Searsburg West - October 29, 2004

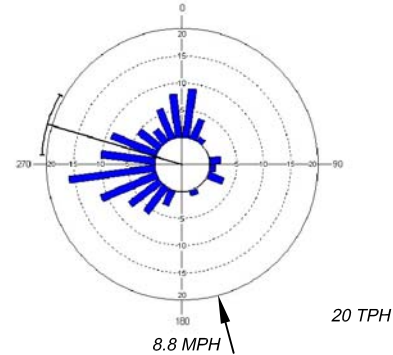

Entire Season - Searsburg West

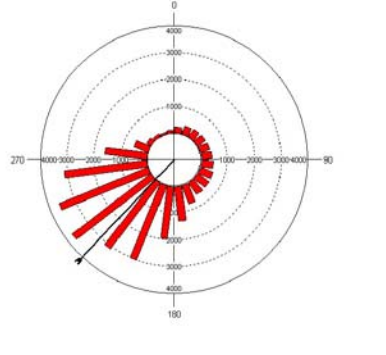

Entire Season - All Sites

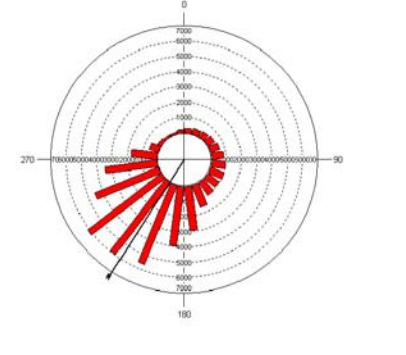

**RADAR DATA ROSE LEGEND**

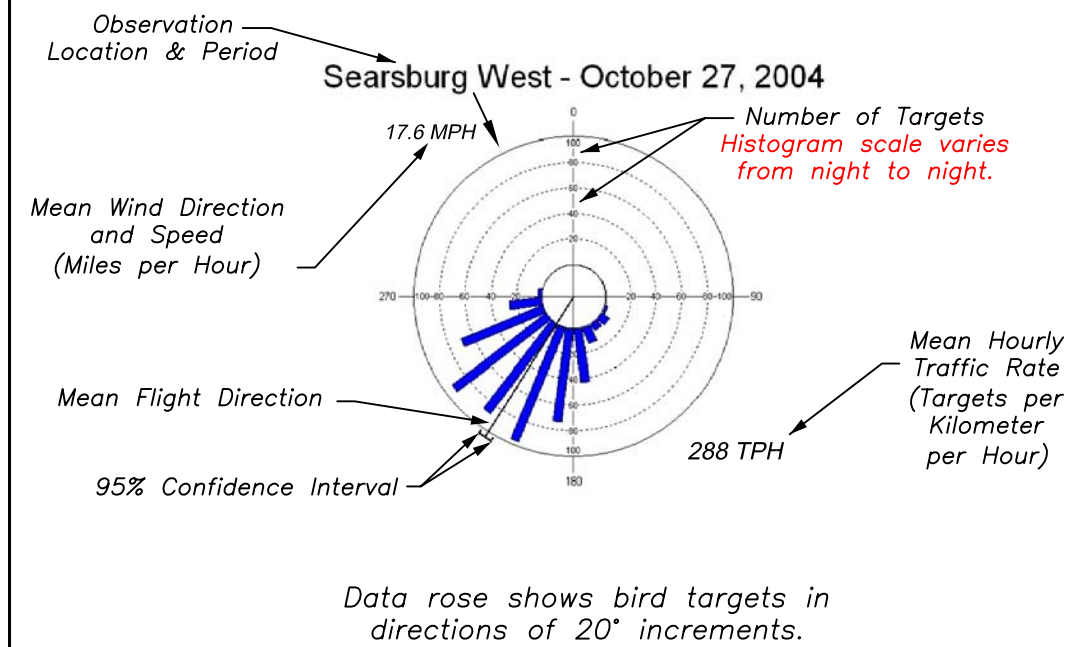

NO.	REVISIONS	DATE

SHEET TITLE: Appendix C - Nightly Mean Flight Direction  
Western Expansion Area

SCALE: N/A

DATE: January 2005

PROJECT: Searsburg Avian Studies

ADDRESS: Searsburg Vermont

