

Partnership for Wave Power - Roadmaps



Wave Energy Technology Roadmaps

K. Nielsen, J. Krogh, H. J. Brodersen, P. R. Steenstrup, H. Pilgaard, L. Marquis, E. Friis-Madsen, J. P. Kofoed

EUDP 13-I J.nr. 64013-0107

ISSN 1901-726X

DCE Technical Report No. 186



DEPARTMENT OF CIVIL ENGINEERING
AALBORG UNIVERSITY

Aalborg University

Department of Civil Engineering

Water and Soil

DCE Technical Report No. 186

Partnership for Wave Power - Roadmaps

By

Kim Nielsen, Jan Krogh, Hans Jørgen Brodersen
Per Resen Steenstrup, Henning Pilgaard,
Laurent Marquis, Erik Friis-Madsen and Jens Peter Kofoed

April 2015

© Aalborg University

Scientific Publications at the Department of Civil Engineering

Technical Reports are published for timely dissemination of research results and scientific work carried out at the Department of Civil Engineering (DCE) at Aalborg University. This medium allows publication of more detailed explanations and results than typically allowed in scientific journals.

Technical Memoranda are produced to enable the preliminary dissemination of scientific work by the personnel of the DCE where such release is deemed to be appropriate. Documents of this kind may be incomplete or temporary versions of papers—or part of continuing work. This should be kept in mind when references are given to publications of this kind.

Contract Reports are produced to report scientific work carried out under contract. Publications of this kind contain confidential matter and are reserved for the sponsors and the DCE. Therefore, Contract Reports are generally not available for public circulation.

Lecture Notes contain material produced by the lecturers at the DCE for educational purposes. This may be scientific notes, lecture books, example problems or manuals for laboratory work, or computer programs developed at the DCE.

Theses are monographs or collections of papers published to report the scientific work carried out at the DCE to obtain a degree as either PhD or Doctor of Technology. The thesis is publicly available after the defence of the degree.

Latest News is published to enable rapid communication of information about scientific work carried out at the DCE. This includes the status of research projects, developments in the laboratories, information about collaborative work and recent research results.

Published 2015 by
Aalborg University
Department of Civil Engineering
Sofiendalsvej 9-11
DK-9200 Aalborg SV,

Printed by Aalborg University.dk

ISSN 1901-726X
DCE Technical Report No. 186

Contents

Partnership for Wave Power - Roadmaps.....	1	AP 2 Roadmap for mooring systems.....	9
Wave Energy Technology Roadmaps.....	1	1 Connections.....	9
Introduction and Purpose	1	2 Energy production.....	9
Foreword.....	2	3 Integrations	10
Long term development plan.....	3	4 Safety and cost	10
1 Prototype Test and Demonstration	4	Collaborative and Individual developments projects	10
2 Demo Parks	4	AP 3 Roadmap for development of PTO-systems.....	11
3 Large Demo Parks.....	4	Collaborative and Individual developments projects	12
4 Off shore Energy Park	4	AP 4 Roadmap for Power-transmission from floating WEC to sea bed ..	13
Development Plan for Target Costs for Danish Wave Power	5	Collaborative and Individual developments projects	14
Reducing the Cost of Energy	6	AP 5 Roadmap for Materials and Components.....	15
OPEX.....	6	Collaborative and Individual developments projects	15
Summary of Development Themes and Recommendations	7	References:.....	16
<i>Structure & Prime mover</i>	7	Annex 1 Danish Wave Energy Converters.....	17
<i>PTO - Mechanical & electrical</i>	7	Introduction and summary	18
<i>Foundations & moorings</i>	7		
<i>Grid connection</i>	7		
<i>Installation</i>	7		
Conclusions	8		
Wave Power off-shore research test rig	8		
Supplementary Recommendations.....	8		

Disclaimer: In this EUDP financed project report "Partnership for Wave Power - Roadmaps" the Danish Partnership for Wave Power describes in roadmaps the development requirements for Wave Power in Denmark. EUDPs co-financing of the project does not necessarily mean that the roadmaps describes or express the views of the Danish Energy Agency nor the Danish Energy Technology Development and Demonstration Program EUDP.

Partnership for Wave Power - Roadmaps

The Partnership for Wave Power is a network stimulating innovation related to converting wave energy.

The roadmaps in this report describes themes that need research and development to reach the targets and long term visions set up in the Partnership Strategy of 2012:

“By 2030 at the latest, wave energy technologies must provide a cost-effective and sustainable electricity supply from offshore energy farms in Denmark”



Partnerskabet for **Bølgekraft**



Wave Energy Technology Roadmaps

Prepared by the Partnership for Wave Power for the Energy Development and Demonstration Program EUDP

Introduction and Purpose

Technology roadmaps are tools that provide a framework for stimulating innovation in specific technology areas to achieve a long term vision, target or goal.

The aim of these roadmaps is to help the emerging wave energy sector in Denmark to develop cost-effective solutions to convert Wave Energy.

This Wave Energy Technology Roadmap is developed by the Partnership for Wave Power including nine Danish wave energy developers. It builds on to the strategy [1] published by the Partnership in 2012, a document that describes the long term vision of the Danish Wave Energy sector: *“By 2030 at the latest, wave energy technologies must provide a cost-effective and sustainable electricity supply from offshore energy farms in Denmark”*.

For this to happen the funding agencies must consider support mechanisms that can attract private investments i.e. by creating artificial markets for small wave energy farms. The research, knowledge and experience emerging from such wave energy farms could become a shared public-private property administrated by the Partnership for Wave Power.

This Roadmap describes the challenges in engineering and cost and provides suggestions how to address these to enable the Danish wave power industry to progress.

Foreword

EUDP 13-I project “Partnership for Wave Power – roadmaps”

J.nr. 64013-0107, EUDP contact Hanne Thomassen

The project has been structured around work packages each with a dedicated coordinator and group as described below:

WP1 Project steering, Co-ordination and Reporting

*DanWEC, Hans Jørgen Brodersen; AAU, Jan Krogh & Jens Peter Kofoed
Development/v Kim Nielsen*

WP2 Roadmap for mooring systems

Crestwing, Henning Pilgaard

WP3 Roadmap for PTO-systems

Wavestar, Laurent Marquis

WP4 Roadmap for Power-transmission from floating structure to the seabed

Resen Energy, Per Resen Steenstrup

WP5 Roadmap for materials and components

Wave Dragon, Erik Friis-Madsen

WP6 Dissimination

OCD, Hans A Petersen

In addition Floating Power Plant v Anders Køhler, Leancon v Kurt Due Rasmussen, WavePlane v Erik Skaarup and Eaconsult v Erik Adam Pedersen have participated in the workshops and contributed to the project. The project has included four milestones related to main workshops for the whole Partnership group.

Milestone M1 Workshop 1 Establishment of workgroups (kick-off 16. September 2013 Hanstholm)

Milestone M2 Workshop 2 Identification of main elements in the roadmaps (d. 31/01/2014 Fredericia)

Milestone M3 Workshop 3 Conventions and dimensions of the roadmaps including LCOE (27/08/2014 AAU/CPH)

Milestone M4 Workshop 4 Presentation and discussion of the four draft roadmaps (25/11/2014 AAU/CPH)

In addition to these workshops, work has taken place in smaller group’s including meetings in person and electronic meetings. Individuals from other sectors and institutions have also been involved and participated in a positive and engaged manner that has contributed to the development of the partnership and these reported roadmaps.

The Danish Partnership for Wave Power acknowledges the effort that Jan Krogh and Hans Jørgen Brodersen at DanWEC have contributed to inspire co-operation and the co-ordination of this road-map project.

On behalf of the Danish Partnership for Wave Power it is my hope that the work with these roadmaps will continue to inspire the partners and the funding agencies to successful development of Wave Energy Systems, and that testing of a relative wide range of small prototype systems in the coming years – will provide the basis for collective compilation of experience as a basis for commercial development of wave energy.

Kim Nielsen

16-04-2015 Chairman for the Danish Partnership for Wave Power

Long term development plan

The Danish Partnership for Wave Power propose a long term development plan for Wave Power in Denmark as shown on figure 1 below. Each development step is associated with an estimated Lavelized Cost of Energy LCOE that reduces as the technology matures. A specific feed-in tariff will be one among several factors that can support such a development as described in the strategy 2012 [1]. The tariffs will gradually be reduced and offered for a limited annual energy production over a 10 year period. This report will describe some of the developments necessary on the road to realize this plan.

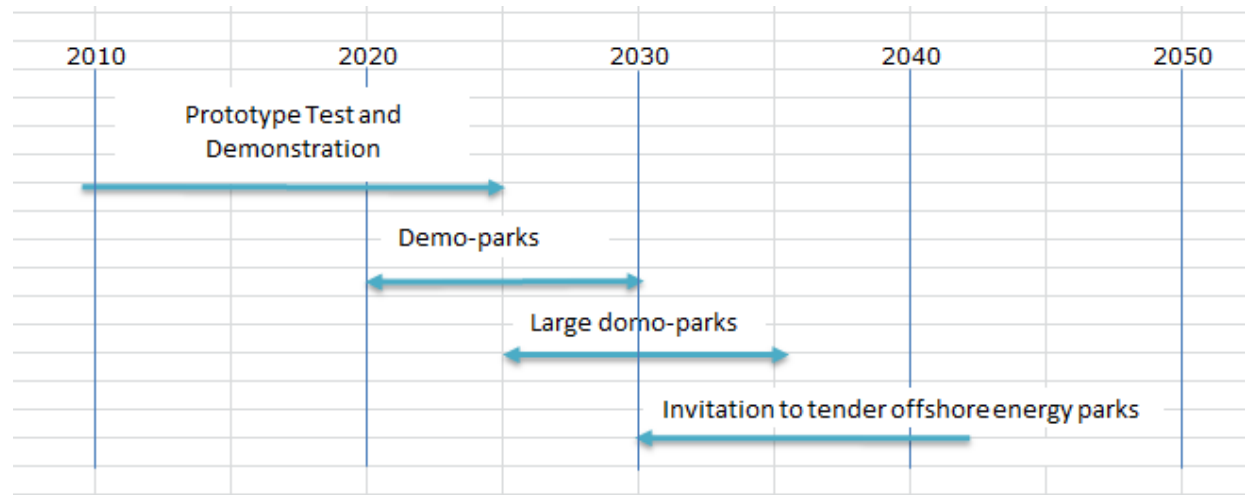

Figure 1 Development plan for Wave energy in the Danish Part of the North Sea.

Table 1 Projected LCOE for the development of wave power convertors in the development plan figure 1

YEAR	Demonstration Capacity MW	Production Limit per Year MWh/Year	LCOE €/MWh	DKK/kWh
2010-2025	2-5	7.000	600	4,5
2020-2030	10-20	30.000	400	3,0
2025-2035	30-60	100.000	200	1,5
2030 -	500 – 1.000	1.500.000	120	0,9

1 Prototype Test and Demonstration

DanWEC "Forsk-VE" Model (2-5 MW, 2010-2025)

The first phase of prototype tests and demonstrations is planned to take place at sheltered sites such as Nissum Bredning and if successful here followed by larger prototype tests at the exposed site at Hanstholm (where the WaveStar project has been tested since 2010).

DanWEC has in 2012 received Greenlab funding to develop the infrastructure of a common offshore test site. This includes measuring equipment and data collection as well as planning of a more permanent grid connection via a mono-pile. At this site the "Forsk-VE" funding model, "a project specific support model", is suggested to be applied which will release funding proportional to the hours of performance above an agreed performance curve (used successfully by Energinet.dk on the WaveStar experiment).

2 Demo Parks

(10-20 MW at 3.0 DDK/kWh, 2020 - 2030)

Demo Parks consist of small arrays i.e. 5 – 10 devices placed in deeper water further offshore at DanWEC Hanstholm or in connection with wind parks such as Horns Rev.

3 Large Demo Parks

(30 – 60 MW at 1.5 DDK/kWh, year 2025 - 2035)

The large Demo Parks with arrays of more than 20 devices should be regarded as power plants in line with today's offshore wind projects. These parks are established in order to gain confidence in the operational and maintenance issues in the preparation and planning for larger combined wind and wave projects in the North Sea. Maritime spatial planning must be addressed before this period.

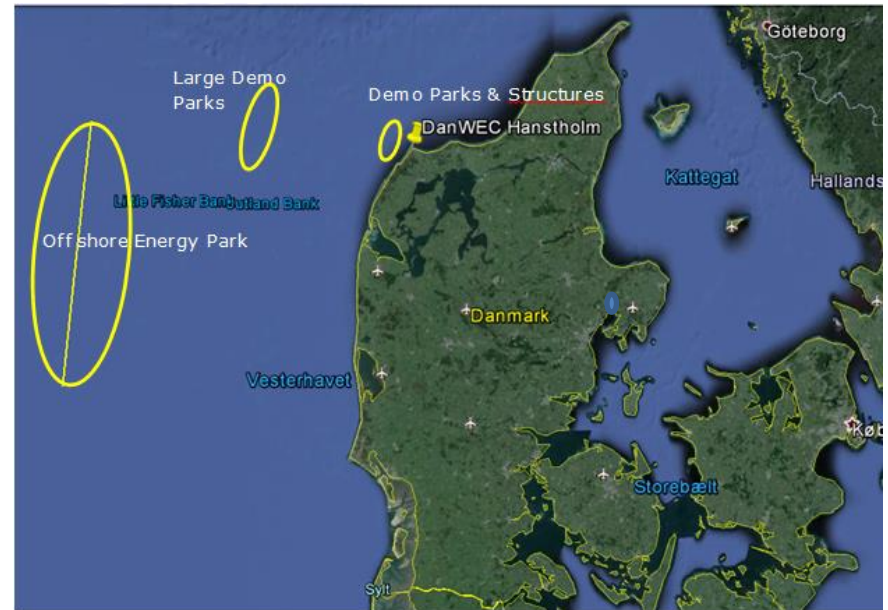

Figure 2 Sites should be planned and prepared for Wave Energy Parks

4 Off shore Energy Park

(500 – 1000 MW at 0.9 DDK/kWh, from 2030 onwards)

The largest wave energy resource in Denmark is in the central part of the North Sea as indicated on figure 2 the water depth is about 45 meter and the resource on an average about 15kW/m. The distance to shore is some 100 - 150 km and common transmission cables should be a joint undertaking between wave energy technologies and offshore wind projects. The planning of the use of sea space is a national undertaking but many issues common to other European countries is described in EU Blue Energy at Sea [2]. The target is that combined offshore energy parks could be put for tender at 0.9 DDK/kWh.

Development Plan for Target Costs for Danish Wave Power

In order to reach the target of installed produced energy – as well as target Cost of Energy of 0.90 DKK/kWh the plan figure 3 below shows how this target can be reached, guided by the overall development of Capital Expenses CAPEX and Operating Expenses OPEX with set targets for life time, Load factor (capacity factor) and availability . The Danish Partnership for Wave Power has developed its own version of a calculation tool for LCOE is described in [P1] based on the same principles as described in the SI Ocean report [3].

DK Development Plan Wave Power Danish part of the North Sea	2015-2020	2020-2025	2025-2030	2030-50
Installed Power [MW]	4 MW	15 MW	40 MW	500 MW
Annual Production [MWh/y]	7.000 mWh/Y	30.000 MWh/Y	100.000 MWh/Y	1.500.000 MWh/Y
CAPEX [DKK/kW]	45.000 DKK/kW	35.000 DKK/kW	20.000 DKK/kW	20.000 DKK/kW
OPEX [DKK/kW]	2.000 DKK/kW/Y	1.750 DKK/kW/Y	1.000 DKK/kW/Y	750 DKK/kW/Y
Life time [Years]	10	10	10	20
Load factor [%]	25%	25%	30%	35%
Availability [%]	80%	90%	95%	98%
Annualized O&M Costs [DKK/kWh]	1.14	0.88	0.40	0.25
LCOE	4.5 DKK/kWh	3.0 DKK/kWh	1.5 DKK/kWh	0.90 DKK/kWh
Amortisations factor	0.13	0.13	0.13	0.09
Interest r	0.05	0.05	0.05	0.07

Figure 3 Targets for the development of installed and produced wave power as well as targets for the development of CAPEX, OPEX, lifetime, Availability and Capacity factor

The development in cost as described above is similar to the development that took place in the development of wind energy – in which the graduate development of larger turbines in itself contributed to cost reductions [4].

Reducing the Cost of Energy

Typical cost centers and drivers within CAPEX and OPEX for power plants based on Wave Energy Converters is shown in the table below [3].

Table 2 Typical subdivision and main drivers of CAPEX and OPEX for Wave Energy Converters

COST CENTERS		MAIN DRIVERS	EXAMPLE MEASURE
CAPEX	<i>Project development</i>	Planning Project production facility Insurance Permissions	
	<i>Structure & Prime mover</i>	Production facilities and methodologies Material cost Extreme loads Coatings	Cost/ton
	<i>PTO - Mechanical & electrical</i>	Rating of the machine Wave climate Controle	Rated power/mean power output
	<i>Foundation & Moorings</i>	Water depth, Tidal range Tidal flow, Storm conditions Compliance, Type of WEC systems Redundancy, Maritime Spatial Plannig	WEC displacement Mooring load Water depth
	<i>Grid connection</i>	Power transmission level Distance to shore Standardisation of subsea cables Substations alternatives	Cost pr km
	<i>Installation</i>	Type and availability of vessels required Distance to port/terminal/production facility Time taken for installation Weather windows	Vessel type & day rates
OPEX	<i>Planned maintainance</i>	Running costs Cost of replacement part Component design for maintainance Time to complete service Distance to port Weather windows	Dedicated support vessels and equipmet Logistic Standardisation
	<i>Unplanned Maintanance</i>	Cost of replacement parts and spares Time to complete Time waiting for weatherwindow Lost power production Cost of stanby personel and material	

Summary of Development Themes and Recommendations

The common themes - derived from the road map exercise undertaken in the different work packages - is summarized in the table below

Table 3 Development themes and recommendations from Roadmaps

	CAPEX Reduction	Performance improvement	OPEX reduction
<i>Structure & Prime mover</i>	Material optimization Upscaling of devices Batch and serial production Reduced over-engineering Regional manufacturing	Geometry optimization Optimization of array layout Improved reliability	Simpler access Specialist vessels Anti-corrosion Anti-Bio fouling
<i>PTO - Mechanical & electrical</i>	Improved Power electronics Improved hydraulic systems Alternative/Improved PTOs	Improved control system and algorithms Improved hydraulic system Improved met ocean forecasting Drive train optimization Improved power electronics Array yield optimization	Modular subsystems
<i>Foundations & moorings</i>	Improved moorings Improved foundations Improved piling Cost effective anchors for all seabed conditions	Deep water installation techniques	Modular components Improved ROV and autonomous vehicles
<i>Grid connection</i>	Off-shore umbilical/wet-mate connectors Subsea hubs Array electrical system optimization Offshore grid optimization Power transmission co-operation with offshore wind	Optimized high voltage transmission technology AC/DC to reduce losses	Improved connection and disconnection techniques
<i>Installation</i>	Specialist vessels Modularization of subsystems Improvements in met ocean forecasting Fast deployment and other economic Installation methods Subsea and seabed drilling techniques Improved ROV and autonomous vehicles		Specialist vessels

Conclusions

In 2014 the two largest UK wave energy projects the Oyster and Pelamis - as well as Oceanlinx in Australia and OPT in the USA has significantly reduced if not stopped their activities. It appears that these very large prototype experiments have been far more costly than foreseen – and the prospects from further development have not been obvious. This leaves a vacuum in the wave energy business – and raises the questions how best to proceed – and why?

Wave energy is a large and untapped energy source – the challenge in harvesting this resource is related to cost and technology. The best way to proceed is not obvious – the challenge and the development costs are high and the time it takes to learn is long.

There is however still a wide range of unproven promising technologies as well as many interested young talents that has the potential to develop Wave Energy Converters to deliver LCOE as targeted in this roadmap.

The Partnership for Wave Energy behind this Roadmap study supports a long term and step wise development strategy with open sharing of results and lessons learned from real sea experience both with regard to successes and failures.

Wave Power off-shore research test rig

A joint development of a “Partnership for Wave Power test-rig” is one idea which could help providing some of the information and experience identified under each roadmap. Individual components could be tested in large numbers in parallel to find out which ones work and which don't.

Moorings: Improved connection and disconnection techniques, testing of materials and ropes, identify costs and components, improved moorings & foundations (i.e. screw anchors and improved piling)

PTO: installing different prototypes using different types of PTO's side by side will if the output and performance is compared in a systematic way concerning performance reliability etc. result in a more effective and efficient use of limited investment resources.

Power-transmission from floating WECs to sea bed: Cables are expensive to inspect and access during operation. Development of on-line monitoring system for electric cables and mooring systems - can give an early warning of tear and wear, before the damage happens.

Materials: Typical structural materials used in wave energy converters are steel, concrete, composites and flexible materials. Experience on cost durability and bio-fouling can be gathered from parallel testing of the materials on one structure or several structures tested in parallel in the same environment.

Supplementary Recommendations

The Partnership for Wave Energy has during the execution of this project noticed a benefit from co-operation internally within the Partnership. The regular meetings and workshops with themes of common interest have in itself stimulated innovation and confidence. The continuation of such co-operation is highly recommended. The secretariat for the Danish Partnership for Wave Power has since 2015 been placed with Offshoreenergy.dk this will help the Partnership expand and create new links and co-operation with the offshore industry and the offshore wind sector. Such co-operation can i.e. be in areas such as standardization of electrical infrastructures, subsea cables and connections.

AP 2 Roadmap for mooring systems

Typically Wave Energy Converters can be placed in three groups

1. **Bottom Standing** devices (such as Wave Star)
2. **Small absorbers** (i.e. DWP point absorbers and the Resen system)
3. **Large floating structures** (such as Wave Dragon, FPP, Crestwing, Wavepiston, Weptos, Leancon or KNSwing) using a slack mooring system to keep the structure in its mean position. The Danish Wave Energy Systems and their current mooring design are described in the internal partnership report [P2] and three main groups are shown on figure 4.

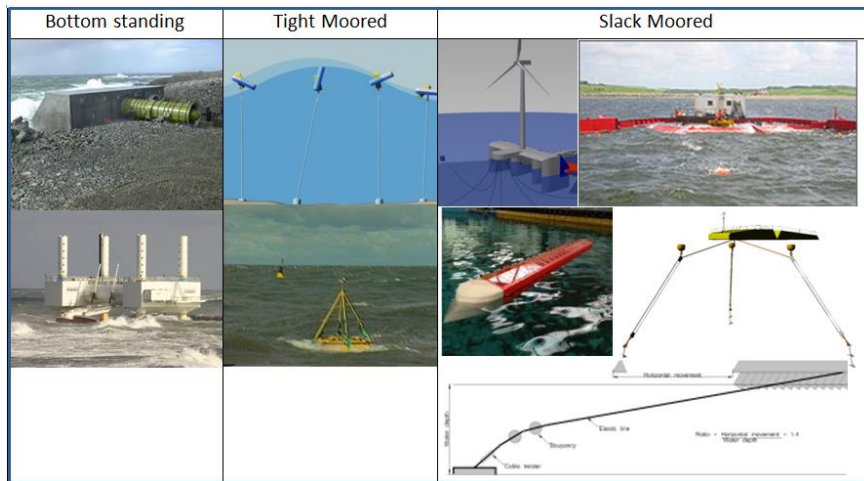

Figure 4 Examples of Wave Energy Converters with different types of mooring system

In general four main concerns have to be addressed in the development of the mooring systems:

1. Connections
2. Energy production
3. Integrations
4. Safety and Cost

1 Connections

All components must have sufficient strength, fatigue life and reliability and marine growth and corrosion must be considered. The mooring can include connections between mooring chain, wire-rope, synthetic lines to special flexible lines (Sea-flex) and floating or submerged buoyancy buoys, sinkers etc.

1.1. On device

The point of connection to the WEC structure should have sufficient strength to handle the loads and at the same time enable easy handling of the connections. Inspection and maintenance must be possible.

1.2. To sea bed

The design of seabed connection depends on the combinations and magnitude of vertical and horizontal mooring loads – interacting with the seabed. This typically includes gravity anchors, drag-embedment anchors, driven pile/suction anchors, screw anchors, vertical load anchors, drilled and grouted anchors or screw anchors and driven anchor plates. The mooring systems with smaller footprints on the seabed will probably be more attractive concerning environmental issues.

2 Energy production

A WEC's mooring system design can in varying degrees, have an impact on the power absorption and can therefore impact the cost of energy. In the design test, it is recommended to determine the influence of alternative mooring designs on the Mean Annual Energy Production of the WEC.

3 Integrations

The integration of the mooring, data transmission and power transmission is strongly interrelated. The interaction with the mooring system design and its reliability affects the electrical transmission cable connection from floating WEC to the seabed described in AP 4 Roadmap for Power transmission.

A highly reliable mooring system will also reduce the risk of damage to electric transmission cable, ensuring the electrical transmission cable during operation.

4 Safety and cost

The mooring design should follow standards related to Wave Energy Converters such as IEC TC 114 PT 10. The lifetime of the mooring system as a whole must be a substantial part of the WEC's lifetime. Redundancy mooring lines are recommended as a design praxis that could lead towards increased reliability of the whole system.

The WEC mooring systems design philosophy is recommended to include an emergency plan for the unlikely case that the mooring system for some reason breaks anyway. Emergency planning and design should include the situation up to, during and after breakaway. Documentation of how the system design includes damage control should be provided.

Mooring costs can contribute to 10-15% of LCOE. Reduction of mooring costs without compromising survivability should be a design objective. This is particularly important in large arrays. Practical configurations for array mooring leading to the reduction of mooring lines may contribute to this objective. Further documentation of the critical variables and choice of technology alternatives with primarily focus on survival, reliability, O & M is required in order to obtain insurance.

Collaborative and Individual developments projects

The Danish partnership for wave energy has promoted greater openness between the otherwise competing partners. Considering alone the sum of each partner's contacts provides a significant background of experience and expertise that all can benefit from.

Experience within wave energy project development from idea to realization shows that, involving third partner's experience can lead to new and improved results. Therefore projects involving multiple cooperating partners can become a very secure way of solving technical and general issues within the sector.

Recommendation of Development Projects	
Mooring systems	
Ongoing (and completed)	
(Wave Star bottom standing), (WaveDragon Mooring design study), (Common pre-study and demonstration of wave energy challenges, AAU, Resen, Crestwing and Ramboll), Leancon prototype 1:10 scale, Mooring solutions for large wave energy converters, AAU, FPP, Leancon, Wave Dragon KNSwing, Prototype Resen , Prototype Wave Piston, Prototype Crestwing	
High Priority Near term (2015 – 2020)	
1.	Improved connection and disconnection techniques
2.	Testing mooring concepts combined with testing of materials and ropes, identify costs and components
3.	Improved moorings & foundations (i.e. Screw anchors and Improved piling)
4.	Cost effective anchors for all seabed conditions
5.	Considerations of array mooring layout

AP 3 Roadmap for development of PTO-systems

One of the common goals of wave power projects is undoubtedly the development of an efficient transformation of the wave energy into electricity via the Power Take Off (PTO) system.

The current status of the PTO technology for wave energy systems are identified and described in the internal partnership PTO status report. It appears that the Danish system Wavestar is unique in the world as it have demonstrated the functionality and the effectiveness of their PTO system in the open water test site DanWEC, survived long enough to get stabilized and robust data on power performance..

The critical system requirements is the effectiveness of the PTO system, including high reliability, controllability and maintainability in order to meet the performance targets of high and stable annual energy production that can meet the grid requirements. The PTO technology alternatives that can satisfy those targets are described in [5] and [6]:

1. Hydraulic systems (oil or high pressure water)

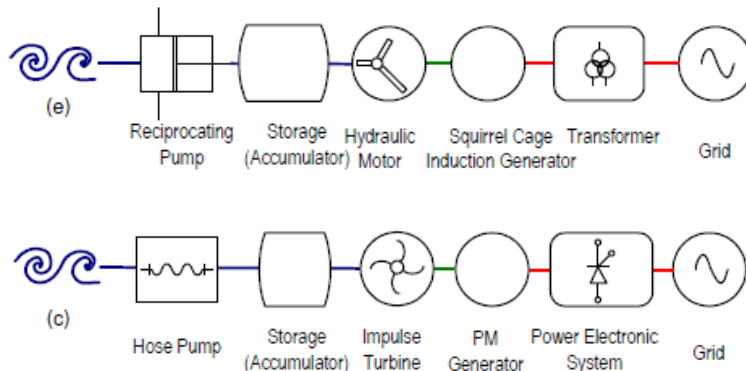

2. Air and water turbine systems

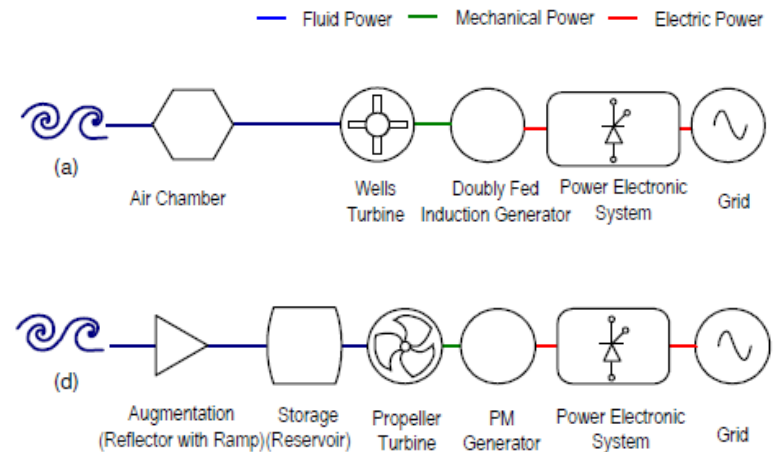

3. Direct mechanic systems

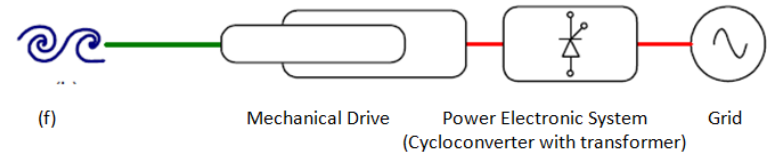

4. Direct electrical systems such as linear generators

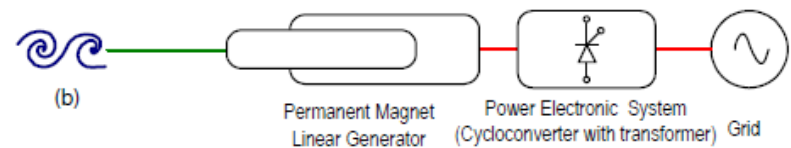

The critical variables that will determine which technology alternatives are selected are cost, reliability, efficiency, and grid compliance in term of power quality.

Collaborative and Individual developments projects

- A collaborative development and implementation effort that, involves installing different prototypes using different types of PTO's side by side will if the output and performance is compared in a systematic way concerning performance reliability etc. result in a more effective and efficient use of limited investment resources.
- The PTO has to be designed for being used in a harsh condition and not only for research purpose. The use of a large test bench is necessary to test the component and the different control strategies. Then the efficiency of the PTO has to be clearly mapped for securing the energy production of the WEC and be a part of the validation process.
- There are many projects for WEC development with the associated PTO system. Only few have been described and no data are really available to compare the efficiency and durability of the different systems.

Technical and Implementation recommendations	
PTO systems	
High Priority near term (2015 – 2020)	
1.	Prototype 1 (hydraulic)
2.	Prototype 2 (air/water)
3.	Prototype 3 (direct drive)
4.	Prototype 4 (electrical drive)
5.	Improved efficiency in hydraulic systems
6.	Power smoothing on combined systems
7.	Optimization of LCOE
Medium term Priority (2020 – 2025)	
1.	Recording data on maintenance
2.	Improved Power electronics
3.	Inverter technology
4.	Generator optimization
5.	Housing of components
Longer term Priority (2025 – 2030)	
1.	Alternative/Improved PTOs for the future with high efficiency
2.	Analyze on combining different system such as wind & wave in term of energy produced (less variation, no 0 production, capacity factor)

AP 4 Roadmap for Power-transmission from floating WEC to sea bed

The Power and data transmissions line(s) from a floating platform and to the seabed is by nature the most critical component after the mooring system as shown on figure 5. If the anchors fail it can be total disaster and if the power and data transmission fails it will mean great losses in down time and repair in a hostile sea.

Based on a common study among all active Danish wave energy developers, the existing alternatives have been identified. It is based on all the generic parameters and drivers that can influence the power and data transmission from the floating WEC and to the touch down point on the sea bed as illustrated on figure 6.

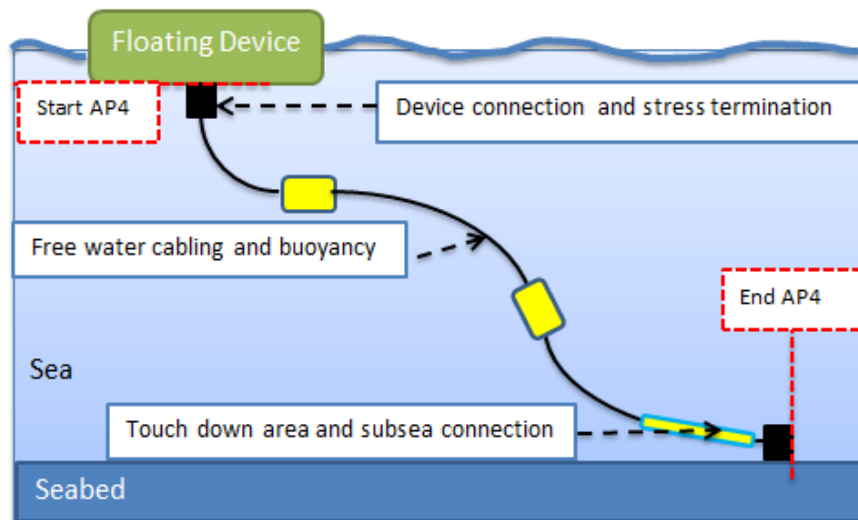

Figure 5 Illustration of the segments involved in the power-transmission from the floating wave energy converter to the seabed.

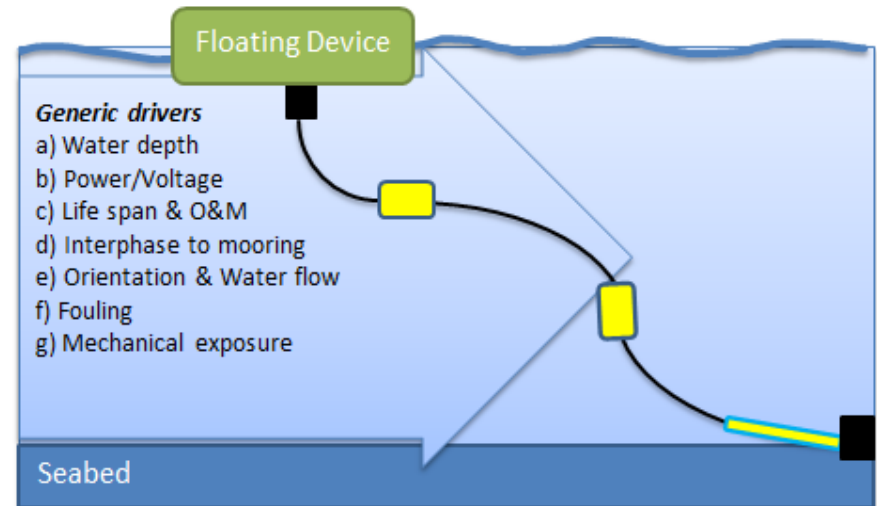

Figure 6 The Generic drivers guiding the solutions to the design problem

Today the solutions could basically be bought as more or less standard offshore products, but the costs, which are acceptable to the oil and gas offshore industry, are way above what is acceptable in the renewable wave energy business.

Therefore it is necessary to get costs down for the WEC developers by learning from the oil and gas industry history and focusing on the areas and components which can give substantial savings in cost of energy. And then industrialize and standardize these solutions among the WEC developers, which eventually will drive the costs down, when the numbers in production are increased.

The main focus in the years to come is to identify areas for common projects with high impact on cost of energy and reliability in general. The 4 general focus areas that will be kept in mind in all future projects are: Reliability, System cost, Installation cost and O&M cost.

Collaborative and Individual developments projects

Development of sensor technology that can monitor integrity on line of anchor lines, power- and data transmission and predict early failure before it happens. Under water anchors and cables are expensive to inspect and access during operation. Development of an on-line monitoring system for anchor chains and electric cables that can give an early warning of tear and wear, before the damage happens is recommended.

Development of a 1kV power and data transmission system. By starting the development and testing of a low power transmission according to the same requirements as a 33 kV system (Cu and fiber), just in smaller scale, early operational lessons can be learnt from the development of a 1kV power and data transmission system. Experience can then be incorporation in development of a 33 kV cable system..

Development and testing of 33 kV cable systems for moored WECs: This project should identify and combine existing cable, bend resistor, device interface and sensor technologies, to best suit the design characteristics of catenary moored WECs. The project should involve dry testing for fatigue and offshore testing for an extended period of time. The intended outcome of the project should be both a proof of concept for the designed cable system, and equally important methods and guidelines for determining the operational environment of cable systems and testing/certification of cable systems.

Development of medium voltage 33 kV slip ring systems for WECs: Development of medium voltage 33 kV slip ring systems for WECs: The project should develop and test slip ring systems specifically designed for WECs. The development should focus on the special requirements in

the WEC sector as water ingress protection, ruggedness (Stress relief, impact resistance), low cost and low maintains requirements.

Technical and Implementation recommendations	
Power-transmission from floating WEC to sea bed	
High Priority near term (2015 – 2020)	
<ol style="list-style-type: none"> 1. Extensive sea testing with many operational hours 2. 5 year interval between services 3. Optimization of cable designs for reliability and price 4. Show documented progress in design, test and operation 5. Certification of products 	<p>Common projects:</p> <ol style="list-style-type: none"> 1. Sensor technology that enables integrity monitoring of cable transmission. Prediction of early failure. 2. Low tension (1 kV) power and data transmission. 3. 33 kV cable system with fiber optic connection. 4. 33 kV slip ring
Medium term Priority (2020 – 2025)	
<ol style="list-style-type: none"> 1. High level of standardization 2. Proven reliability and economics of operation 3. kWh price drops minimum 50% 	
Longer term Priority (2025 – 2030)	
<ol style="list-style-type: none"> 1. Proven reliability and economics of operation 2. kWh price drops minimum 35% (factor x 3 price drop since early prototypes) 	

AP 5 Roadmap for Materials and Components

Identify and describe the **materials and components** for wave energy systems and their current status focusing on the main structures and components of the device.

Typical structural materials used in wave energy converters are:

1. Steel & other metals
2. Concrete
3. Composites
4. Flexible materials

The critical system requirements for the materials and components to meet the performance targets are set in unit costs, expected lifetime and maintenance costs. The choice of materials and component shall ensure high reliability, survivability and maintainability.

Several types of materials can often fulfill the technological targets, but the relations between CAPEX/OPEX are very dependent of the choice of material. Both CAPEX and OPEX are highly dependent of local conditions at the production/deployment site, which means that detailed feasibility studies are necessary in order to make the optimal choice of the structural materials.

Collaborative and Individual developments projects

A collaborative development and implementation effort started as part of the Partnership for Wave Power will result in a more effective and efficient use of limited investment resources, as results and experience from different approaches are shared in a comparable manner.

The shared development approach is crucial – and the public support of the development of one technology that does not share information can be a critical factor (show-stoppers) which will cause the roadmap to fail.

Areas such as exotic polymers for Power take-off are not addressed in the roadmap.

Technical and Implementation recommendations	
Materials og components	
High Priority near term (2015 – 2020)	
1.	Production of at least 5 different prototypes in small scale for testing in DanWEC's sheltered Nissum Bredding test site
2.	Testing and demonstration of different materials on these prototypes i.e. steel, concrete, composites
3.	Building and running 3 different prototypes in ½ scale suited for Hanstholm
4.	Design basis for prototype developments
Medium term Priority (2020 – 2025)	
1.	Development of small array
2.	Optimization of structure
Longer term Priority (2025 – 2030)	
1.	Optimization

References:

- [1] Bølgekræftteknologi Strategi for Forskning, Udvikling og Demonstration 2012, K. Nielsen, J. Krogh, N. E. H. Jensen, J. P. Kofoed, E. Friis-Madsen, B. V. Mikkelsen, A. Jensen
- [2] http://ec.europa.eu/maritimeaffairs/policy/maritime_spatial_planning/index_en.htm
- [3] Ocean Energy: Cost of Energy and Cost Reduction Opportunities, SI Ocean, May 2013;
http://www.si-ocean.eu/en/upload/docs/WP3/CoE%20report%203_2%20final.pdf
- [4] Risø-R-1247(DA) Økonomi for vindmøller i Danmark, Etablerings-, drifts- og vedligeholdelsesomkostninger for udvalgte generationer, Peter Hjuler Jensen, Poul Erik Morthorst, Strange Skriver, Mikkel Rasmussen, Helge Larsen, Lars Henrik Hansen, Per Nielsen og Jørgen Lemming. Forskningscenter Risø, Roskilde, Oktober 2002
- [5] Generic WEC System Breakdown, Bornha Hamedni, Cocho Mathieu, Claudio Bittencourt Ferreira SDWED,
www.sdwed.civil.aau.dk/digitalAssets/97/97538_d5.1.pdf
- [6] Potential opportunities and differences associated with integration of ocean wave and marine current energy plants in comparison to wind energy Grids Jahangir Khan, Gouri S. Bhuyan, and Ali Moshref Powertech Labs Inc March 2009 Final Annex III Technical Report IEA-OES Document No: T0311
[http://www.ocean-energy-systems.org/library/oes-reports/annex-iii-reports/document/potential-opportunities-and-differences-associated-with-integration-of-ocean-wave-and-marine-current-energy-plants-in-comparison-to-wind-energy-2009-/](http://www.ocean-energy-systems.org/library/oes-reports/annex-iii-reports/document/potential-opportunities-and-differences-associated-with-integration-of-ocean-wave-and-marine-current-energy-plants-in-comparison-to-wind-energy-2009/)

Internal reference documents available for the Partnership

- [P1] Partnership for Wave Power, Conventions for Roadmaps and Calculations of LCOE, Kim Nielsen
- [P2] AP 2 Roadmap – forankringssystemer, Internal Partnership report on Moorings, 2014, Henning Pilgaard /Waveenergyfyn, Erik Skaarup/Waveplane, Erik Adam Pedersen/ eaconsult, Kurt Due Rasmussen/Leancon, Anders Køhler/Floating Power Plant
- [P3] AP 3 PTO Partnerskab November 2014, M. Laurent, Wavestar, P. Resen, K. Due, H. Pilgaard



Annex 1 Danish Wave Energy Converters

Danish Partnership for Wave Power

Danish Wave Energy Converters

Roadmap project Annex 1

April, 2015

Introduction and summary

This folder includes a state of the art description of the Danish wave energy systems under development. Each system is presented with summary data concerning estimated dimensions for their target design in the North Sea, as well as power matrices of their absorbed and produced power (based on best measured results).

Principal data from each device is summarized in table 1 below. The first columns indicate the estimated Technology Readiness Level or development step in the ongoing development process within the Danish Partnership for Wave Power. Based on the methodology developed by energinet.dk a simplified LCOE spreadsheet has been developed by the partnership to help guide and verify the developments into future economic wave power solutions. The results of these calculations are presented at the Partnership meetings for debate and inspiration.

Table 4 Summary data concerning the Danish Projects at a location in the central part of the Danish North Sea

TRL ¹	Concept	Rated Power kW	Load factor (wave)	Structure weight [ton]	PTO Type	Mooring type
7	WaveStar	1000 (+5000 Wind)	28%	1.600 (steel)	Oil hydraulic	Bottom standing
7	FPP P70 DK version	1500 (+3600 Wind)	25%	2.000 (steel)	Oil hydraulic	Slack Moored
6	WaveDragon	3200	20%	22.000 (concrete)	Overtopping	Slack Moored
6	Crestwing	800	18%	400 (steel)	Mechanical	Slack Moored
5	WavePiston	285	33%	45(composite)	Water hydraulic	Slack Moored
4	Leancon	4600	22%	1.000 (composite)	OWC	Slack Moored
4	Weptos	3200	23%	1000 (N/A)	Mechanical	Slack Moored
4	WavePlane	75	24%	90 (steel)	Overtopping	Slack Moored
4	Resen	5	49%	1(composite)	Mechanical	Reactive
4	KNSwing	5000	20%	44.000(concrete)	OWC	Slack Moored
3	Joltec	N/A			Gyro	Reactive
Historic systems						
6	PA (2000)	100	12%	50	Oil hydraulic	Reactive
7	DWP (1992-96)	100	13%	60	Water hydraulic	Reactive
6	Dexa (2008)				Oil hydraulic	Slack Moored

¹ See definitions at the last page

WaveStar <http://wavestarenergy.com/>
 (Hansthholm project photo 2013)

WaveStar has been tested at DanWEC facing the North Sea during 2011 – 2013, at the pier Roshage in Hansthholm.

The project has been funded by EUDP and by Forsk-VE. A project-specific support condition was agreed between Wave Star and Forsk-VE – which included a specific target performance curve, leading to full time operation and the production of 41.180 kWh in 2012.

The Hansthholm device included two floats of \varnothing 5 m. In a sea conditions of $H_s = 1,6$ m the measured average absorbed power from one float was about 15 KW.



Dimension (Demonstration version)

Wave Star, C6	Demo
Main dimension (distance between units)	120
Secondary dimension (length/width)	80
no of "absorbers per unit"	20
Absorber dimension [m]	6
Water depth [m]	20

Main structure

Total dry weight [ton] 1600

PTO

Rated Power Wave	1000
Rated Power Wind	5000
PTO average efficiency [%]	80%

Electrical connection

Voltage level [kV]	20
Length [m]	10.000

Mooring, Joints and connectors

Mooring type: Fixed bottom standing pile foundations.

Power matrix (based on best measured)

Target Absorbed Power [kW]

Hs\Tz	3	4	5	6	7	8	9
>5.5							
5							
4				2001	1798	1603	1436
3			1353	1325	1212	1092	985
2		564	704	724	683	627	572
1	88	163	219	243	243	231	216

Electrical Power [kW]

Hs\Tz	3	4	5	6	7	8	9
>5.5						0	0
5					0	0	0
4				1000	1000	1000	1000
3			1000	1000	970	874	788
2		451	563	579	546	502	458
1	71	131	175	194	194	185	173

Floating Power Plant FPP: <http://www.floatingpowerplant.com/>
 FPP floating power plant transforms wind - and wave energy into electricity at the same time. This will drive the cost of energy down e.g. in respect to O&M. Floating Power Plant has built and successfully completed 4 offshore test with a 37 meter wide scaled model at Vindeby off-shore wind turbine park in 2008 - 2013 in Denmark.

A scale Poseidon plant for a Danish site would measure approximate 70 meters depending on wave and wind conditions. In Danish waters the total installed power will be 5.1 MW, including one single center-placed 3.6 MW wind turbine and 1.5 MW wave power.

A full scale UK device will have 5 MW wind & 2.6 MW of wave power.

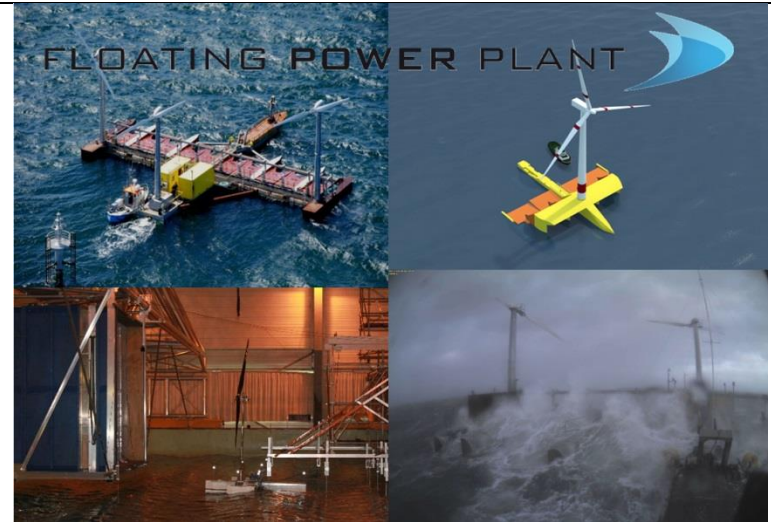

Dimension ("Low" wave energy Danish-site version)

Floating Power Plant

	Target
Main dimension length [m]	70
Secondary dimension with [m]	70
no of "absorbers per unit"	4
Absorber dimension [m]	15
Water depth [m]	40

Main structure

Total dry weight [ton]	2000
------------------------	------

PTO

Rated wave Power [kW]	1500
Rated Wind Power [kW]	3600
PTO average efficiency [%]	80%

Electrical connection

Voltage level [kV]	33
Electrical cable Length [m]	750

Mooring, Joints and connectors

Torrent mooring	
Max load [kN]	4000

Target Performance:

Target Absorbed Power [kW]

Hs\Tz	3	4	5	6	7	8	9
>5.5						4117	4051
5					3563	3571	3524
4				2409	2517	2529	2508
3			1326	1504	1560	1565	1552
2		473	645	709	721	711	695
1	36	92	121	128	124	116	106

Electrical Power [kW]

Hs\Tz	3	4	5	6	7	8	9
>5.5						1500	1500
5					1500	1500	1500
4				1500	1500	1500	1500
3			1061	1203	1248	1252	1241
2		378	516	567	577	569	556
1	29	73	97	103	99	92	84

WaveDragon www.wavedragon.net

Wave Dragon is a floating, slack-moored energy converter of the overtopping type. This means that the waves push water up into a reservoir from where it runs back into the sea through a water turbine.

An experimental 1:4 scale prototype connected to the grid was deployed and tested in Nissum Bredning, during 2003 -2010. This long term testing has helped determine the systems availability and power production in different sea states.

The energy absorption performance has been independently verified and focus will now be on power production optimization.



Dimension (Demonstration version)

<i>Wave Dragon 4MW</i>	Demo
Main dimension (distance between arms)	260 m
Secondary dimension (<u>length</u> / <u>width</u>)	150 m
no of "turbines per unit"	16
Absorber dimension [m]	260
Water depth [m]	20 - 40

Main structure

Total dry weight [ton]	22.000
------------------------	--------

PTO

Rated Power [kW]	4000
PTO average efficiency [%]	80%

Electrical connection

Voltage level [kV]	10
Length [m]	1.000

Mooring, Joints and connectors

Mooring type: Single point mooring

Target Performance

Absorbed Power kW

Hs\Tz	3	4	5	6	7	8	9
>5.5						4000	4000
5					3875	4000	4000
4				2488	3163	3675	3375
3			1225	1538	1850	2275	2025
2		695	825	935	1130	812	337
1	205	292	334	334	380	341	231

Electrical Power kW

Hs\Tz	3	4	5	6	7	8	9
>5.5						3000	3000
5					2906	3000	3000
4				1866	2372	2756	2531
3			919	1153	1388	1706	1519
2		521	619	701	848	609	253
1	154	219	251	251	285	256	173

Crestwing <http://crestwing.dk/>

The Crestwing system has been tested at AAU in 2008 and at DHI in 2010. Since 2011 Crestwing has been testing in real sea conditions in scale 1:5 in Frederikshavn.

The Crestwing is based on the hinged raft principle. The two pontoons are connected with hinges. The angular rotation around the hinge is activating a push rod which, through a gear turns a generator.

The power take off system is developed by Crestwing and placed dry in a large engine room within one of the pontoons.

The mooring system based on flexible mooring lines Seaflex is being tested.

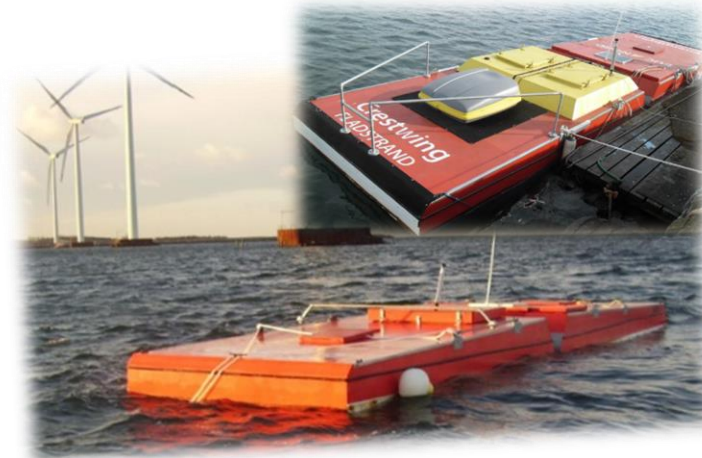
Dimension (Target version)

<i>Crestwing</i>	Target
Main dimension width [m]	30
Secondary dimension length [m]	80
no of "absorbers per unit"	-
Absorber dimension [m]	-
Water depth [m]	45
Main structure	
Total dry weight [ton]	400
PTO	
Rated Power	800
PTO average efficiency [%]	90%
Electrical connection	
Voltage level [kV]	1
Electrical cable Length [m]	200
Mooring, Joints and connectors	
Mooring type: Flexible seaflex triple	
Max load [kN]	4000

Target Performance:
Electrical Power [kW]

Hs\Tz	3	4	5	6	7	8	9
>5.5						800	800
5					800	800	800
4				768	768	768	768
3			372	372	372	372	372
2		140	140	140	140	140	140
1	23	23	23	23	23	23	23

Absorbed Power [kW]

Hs\Tz	3	4	5	6	7	8	9
>5.5						2418	2418
5					1474	1474	1474
4				853	853	853	853
3			414	414	414	414	414
2		155	155	155	155	155	155
1	26	26	26	26	26	26	26

Wavepiston: <http://www.wavepiston.dk/index.html>

The Wavepiston concept is designed to utilize the horizontal oscillating movement of ocean waves into usable energy.

Neutral buoyant vertical plates are placed along a submerged pipe – to which pumps are attached. The pumps are activated by the plates and over the stretch of the pipe the pull and push of the plates more or less equals out so the resulting force on the string is small.

The fluid in the pumps is sea water and the pressurized fluid will turn a high pressure turbine (100 bar) that drives a generator.

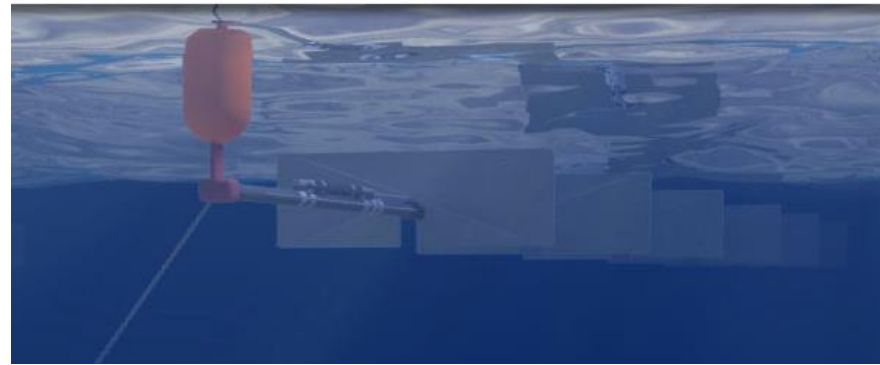

Dimension (Target version)

<i>Wavepiston</i>	Target
Main dimension length [m]	600
Secondary dimension with [m]	10
no of "absorbers per unit"	30
Absorber dimension [m]	10
Water depth [m]	25
Main structure	
Total dry weight [ton]	45
PTO	
Rated Power [kW]	285
PTO average efficiency [%]	80%
Electrical connection	
Voltage level [kV]	10
Electrical cable Length [m]	1000
Mooring, Joints and connectors	
300 m Chain and Drag plate anchors	
Max load [kN]	4000
Compliance [m]	40

Target Performance:

Target Absorbed Power [kW]

Hs\Tz	3	4	5	6	7	8	9
>5.5						200	200
5					310	310	310
4				356	356	356	356
3			307	307	307	307	307
2		171	171	171	171	171	171
1	47	47	47	47	47	47	47

Electrical Power [kW]

Hs\Tz	3	4	5	6	7	8	9
>5.5						160	160
5					248	248	248
4				285	285	285	285
3			246	246	246	246	246
2		137	137	137	137	137	137
1	38	38	38	38	38	38	38

Leancon <http://www.leancon.com/>
 LEANCON was established in 2003 with measurements in own wave flume, at University of Aalborg and off shore in the autumn of 2007 (photo).

Leancon is based on the principle of Oscilating Water Collumns OWC's which in this case is collected to a few turbines via rectifying valves. The only moving parts, besides the 8 turbines and generators, are the valves above the OWC tubes.

Energinet.dk has funded to build test and measure the energy production from a s 24 meter wide scale 1:10 model. This will be tested in Nissum Bredning during spring 2015.



Hydraulic evaluation of the LEANCON wave energy converter (Scale 1:40)
 J. P. Kofoed, P. Frigaard, January 2008

Dimension (Target version)

<i>Lancon</i>	Target
Main dimension length [m]	240
Secondary dimension with [m]	110
no of "absorbers per unit"	80
Absorber dimension [m]	6
Water depth [m]	40
Main structure	
Total dry weight [ton]	1000
PTO	
Rated Power [kW]	4600
PTO average efficiency [%]	80%
Load Factor	22%
Electrical connection	
Voltage level [kV]	33
Electrical cable Length [m]	1000
Mooring, Joints and connectors	
Max load [kN]	5300
Compliance [m]	50

Target Performance:

Electrical Power [kW]

Hs\Tz	3	4	5	6	7	8	9
>5.5	0	0	0	0	0	4600	4600
5	0	0	0	0	4320	4320	4320
4	0	0	0	3072	2560	2560	2560
3	0	0	2160	1728	1440	1440	1440
2	0	768	960	768	640	640	640
1	128	192	240	192	160	160	160

Target Absorbed Power [kW]

Hs\Tz	3	4	5	6	7	8	9
>5.5						7200	7200
5				0	5400	5400	5400
4				3840	3200	3200	3200
3			2700	2160	1800	1800	1800
2		960	1200	960	800	800	800
1	160	240	300	240	200	200	200

Weptos <http://www.weptos.com/>

WEPTOS (wave energy power take off system) extracts wave energy in a new and innovative manner. The wave energy converter is able to regulate the angle of the V shaped floating construction and thereby reduce the impact during rough weather conditions.

The V-shaped structure absorbs the wave energy through a line of rotors (Salter Ducks), which each transmits energy to a common axle, directly attached to a generator. This gives a more smooth energy generation, suited for known generator solutions.

Weptos have completed test in small scale in AAU 2008, as well as large scale model tests in Spain 2011 (photo) as well as experiments under the Marinet program.

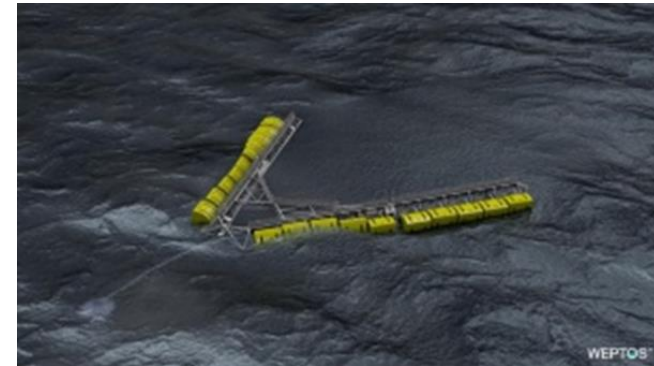

Dimension (ref. paper RENEW 2014)

WEC model		Demonstration		Commercial WEC	
Location		DanWEC Pt 1	Danish North Sea Pt 3	EMEC	Yeu Island
Wave power level	[kW/m]	9	16	29	26
Water depth	[m]	29	39	~50	
$H_s, 100\text{ years}$	[m]	9.5	10.0	16.4	
$T_p, 100\text{ years}$	[s]	16.8	14.5		
Rotors					
amount	[#]		20		
diameter	[m]	4.5	6.8	7.9	
width	[m]	5.4	8.3	9.6	
WEC					
Leg length	[m]	108	162	189	
Total weight	[ton]	1130	3532	5480	
Ballast weight	[ton]	490	2520	4100	
Generator capacity	[kW]	750	3200	4000	
Power production					
Average $P_{\text{electrical}}$	[kW]	132	763	1087	1113
MAEP	[MWh/year]	1335	5329	9532	9758

N/A

Resen Waves <http://www.resenwaves.com/>

The Resen Waves Lever Operated Pivoting Float (LOPF) is based on up tight moored buoy modules.

The buoys consist of a float and a water proof arm, with a gear and a generator. One end of the arm is tension moored to the seabed. When waves push or lift the float up and down, the arm turns forth and back and activates the generator.

For a 5 kW buoy, the main active dimension of the buoy is 2.4 m and the dry weight is 700 kg. They are designed for full ocean exposure and have excellent survivability in big waves, thanks to the patented LOPF, which means the buoy streamlines itself when exposed to big waves. Even during storms the buoys produce electricity. The buoys can be organized in groups to achieve the desired power level.



Courtesy of: www.matthew-oldfield-photography.com

“Wave Energy, Lever Operated Pivoting Float LOPF study
ForskEl Project no.: 10639 by Lucia Margheritini”

Dimension:

<i>Resen LOPF</i>	Target
Main dimension length [m]	2.4
Secondary dimension with [m]	3.6
no of "absorbers per unit"	1
Absorber dimension [m]	2.4
Water depth [m]	45

Main structure

Total dry weight [ton]	0.7
------------------------	-----

PTO

Rated Power [kW]	5
PTO average efficiency [%]	80%

Electrical connection

Voltage level [kV]	1
Electrical cable Length [m]	100

Mooring, Joints and connectors

Max load [kN]	
Compliance [m]	
Chain [m]	

Target Performance:

Target Absorbed Power [kW]

Hs\Tz	3	4	5	6	7	8	9
>5.5						0	0
5					41	41	41
4				35	35	35	35
3			24	24	24	24	24
2		11	11	11	11	11	11
1	2	2	2	2	2	2	2

Electrical Power [kW]

Hs\Tz	3	4	5	6	7	8	9
>5.5						0	0
5					5	5	5
4				5	5	5	5
3			5	5	5	5	5
2		5	5	5	5	5	5
1	2	2	2	2	2	2	2

WavePlane <http://www.waveplane.com/>

WavePlane - converts the pulsating waves directly into a swirling rotating flow via large guide vanes without any moving parts.

WavePlane has been developed over the years by Erik Skaarup and the largest unit was build and installed outside Hanstholm in 2008.



Dimension:

<i>Wave Plane</i>	Target
Main dimension length [m]	20
Secondary dimension with [m]	20
no of "absorbers per unit"	2
Absorber dimension [m]	15
Water depth [m]	15

Main structure

Total dry weight [ton]	90
------------------------	----

PTO

Rated Power [kW]	70
PTO average efficiency [%]	75%

Electrical connection

Voltage level [kV]	0,4
Electrical cable Length [m]	NA

Mooring, Joints and connectors

Max load [kN]	NA
Compliance [m]	NA
Chain [m]	NA

Target Absorbed Power [kW]

Hs\Tz	3	4	5	6	7	8	9
>5.5						120	120
5					120	120	120
4				100	100	100	100
3			70	70	70	70	70
2		40	40	40	40	40	40
1	10	10	10	10	10	10	10

Target performance

Electrical Power [kW]

Hs\Tz	3	4	5	6	7	8	9
>5.5	0	0	0	0	0	90	90
5	0	0	0	0	90	90	90
4	0	0	0	75	75	75	75
3	0	0	53	53	53	53	53
2	0	30	30	30	30	30	30
1	8	8	8	8	8	8	8

KNSwing Development v/Kim Nielsen

Principle: The attenuator (ship shaped) wave energy converter is planned to be built in concrete. It consists of a central buoyancy volume and along each side is placed wave energy absorbing elements consisting of Oscillating Water Columns (OWC) chambers (20 on each side).

A 3 meter long experimental model (the picture) has been tested at HMRC under the Marinet program 2013 as a phase 1 project, and the results compared to early experiments known as the I beam Attenuator [http://www.fp7-marinet.eu/access-menu-post-access-reports_KNSWING.html]. The project has further formed the basis for a Bachelor and Master student projects at DTU, MEK. A second phase of Marinet II testing has been carried out in at Queens January 2015.

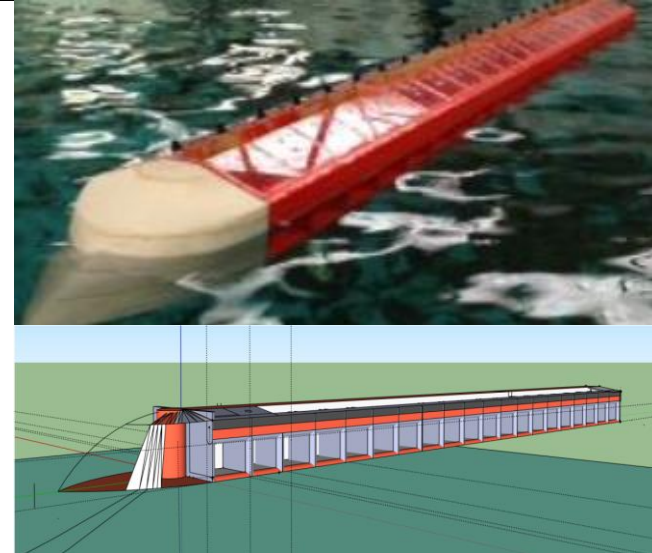
Dimension:

<i>KNSwing</i>	Target
Main dimension length [m]	240
Secondary dimension with [m]	28
no of "absorbers per unit"	40
Absorber dimension [m]	8
Water depth [m]	45

Main structure

Total dry weight concrete [ton]	45.000
---------------------------------	--------

PTO

Rated Power [kW]	6000
PTO average efficiency [%]	80%

Electrical connection

Voltage level [kV]	1
Electrical cable Length [m]	200

Mooring, Joints and connectors

Max load [kN]	8200
Compliance [m]	50

Performance
Target Absorbed Power [kW]

Hs\Tz	3	4	5	6	7	8	9
>5.5						11566	12114
5					7997	8032	8413
4				5052	5273	5140	5384
3			3116	2916	3053	2991	3141
2		1285	1412	1363	1396	1418	1446
1	166	299	346	332	330	332	312

Target performance
Electrical Power [kW]

Hs\Tz	3	4	5	6	7	8	9
>5.5	0	0	0	0	0	5000	5000
5	0	0	0	0	5000	5000	5000
4	0	0	0	4041	4219	4112	4307
3	0	0	2493	2333	2443	2393	2513
2	0	1028	1130	1090	1117	1134	1157
1	133	239	277	266	264	266	249

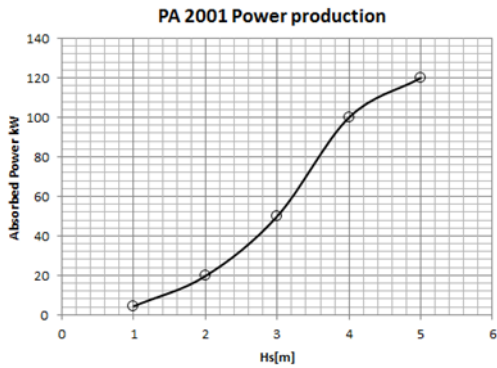
<p>PA Point absorber, Ramboll, (Kim Nielsen) Principle: The float is moved up and down by the waves relative to a gravity/suction cup based seabed structure. This relative motion activates a hydraulic PTO including a hydraulic piston that drives a hydraulic motor that drives a generator. In the hydraulic system is included accumulators that smooth out the pulsating energy from the waves. A synthetic rope is inserted between the hydraulic piston pump and the seabed. Status: During the period survival experiments at DMI juli 1998, power production and experiments in scale 1:10 at DMI June 1999 Testing with Hydraulic PTO was tested in scale 1:4 at DTU (dry test) and in the flume at DMI spring 2001 followed by a feasibility study of a 100 MW plant in the North sea of Denmark.</p>																	
<p>Main data: Water depth: 50 m Diameter: 10 m Height: 2.5 m Float volume: 200 m³ Weight of float: 50 ton Submerged weight of seabed structure: 100 ton</p>		<p>Power take-off: <i>Hydraulisk</i> (65 %) Rated Power electrical: 80 kW (120kW abs) Average Energy Production: 190.000 kWh Electrical - produktion: 116.000 kWh</p> <p>Mooring system: <i>Tight moored</i> Max mooring load: 4.500 kN</p>		<p>PA 2001 Power production</p>  <table border="1"> <caption>PA 2001 Power production data</caption> <thead> <tr> <th>Hs [m]</th> <th>Absorbed Power kW</th> </tr> </thead> <tbody> <tr> <td>1</td> <td>~5</td> </tr> <tr> <td>2</td> <td>~20</td> </tr> <tr> <td>3</td> <td>~50</td> </tr> <tr> <td>4</td> <td>~100</td> </tr> <tr> <td>5</td> <td>~120</td> </tr> </tbody> </table>		Hs [m]	Absorbed Power kW	1	~5	2	~20	3	~50	4	~100	5	~120
Hs [m]	Absorbed Power kW																
1	~5																
2	~20																
3	~50																
4	~100																
5	~120																
<p>Material Choice: Steel: 60 ton Ballast concrete 90 ton</p>		<p>Rapports: <i>Point absorber optimering og design, overlevelsesforsøg, April - November 1998.</i> <i>Point absorber, on the optimization of wave energy conversion, July 1999.</i> <i>Point Absorber Phase 3, Durability testing in Nissum Bredning, RAMBØLL Project report. January 2000</i> <i>POINT ABSORBER TEST IN SCALE 1:4 WITH HYDRAULIC MOTOR, June 2001</i> <i>Point absorber feasibility and development requirements, November 2001</i></p>															
<p>Områder som kræver fortsat udvikling:</p> <ul style="list-style-type: none"> • End-stop component • Hydraulic interconnection of several units • Power transmission 		<p>Danish Wave Energy Programme ENS</p>		<p>Period:1998-2000</p>		<p>Funding: DDK. 2.415.000</p>		<p>Test facilitets DMI, Nissum Bredning, DTU</p>									

Danish Wave Power, Point absorber (Kim Nielsen)

Principle: The float is moved up and down by the waves relative to a gravity/suction cup based seabed structure. This relative motion activates a water hydraulic PTO including a hydraulic piston that drives a Kaplan Turbine that drives a generator. The hydraulic system includes an accumulator that smooth out the pulsating energy from the waves. A synthetic rope is connecting the piston to the float.

History: DWP tested in two periods at Hanstholm – 1992 was a 45 kW unit of 600 ton placed on 30 meter deep water outside Hanstholm – this was followed by a much smaller scale 1:4 experiment with a 2.5 meter diameter float connected to a seabed pump on 25 meter deep water. During the second operating period data over a six month period was obtained on performance and survival loads at Hanstholm in the North sea of Denmark.

Ref. <http://www.waveenergy.dk/files/hanstholmfase2B.pdf>

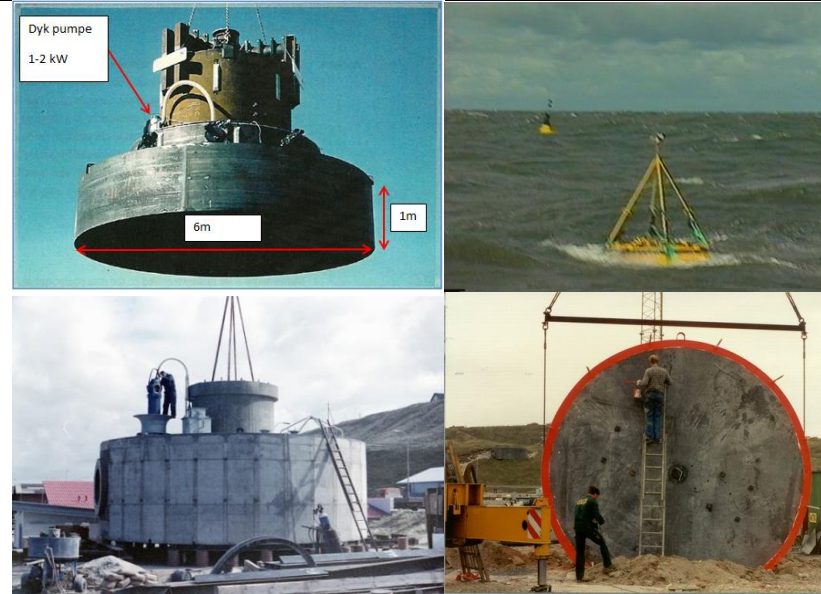
Main data:

Water depth: 50 m

Diameter: 10 m

Height: 2.5 m

Float volume: 200 m³

Weight of float: 50 ton

Submerged weight of seabed structure: 100 ton

Material Choice:

Steel: 60 ton

Ballast concrete 90 ton

Power take-off:

Hydraulisk (75 %)

Rated Power
electrical: 100 kW

Mooring system:

Tight moored
Max mooring
load: 4.500 kN

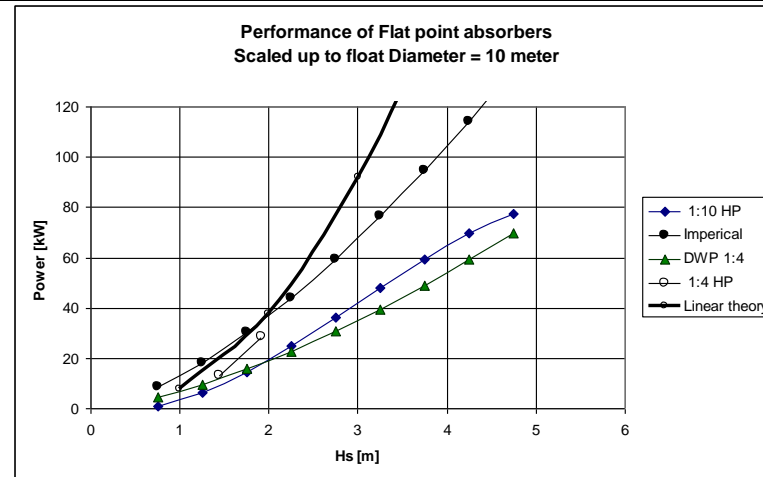

Technology Readiness Levels in the European Commission (EC)

Technology Readiness Level	Description
TRL 1.	basic principles observed
TRL 2.	technology concept formulated
TRL 3.	experimental proof of concept
TRL 4.	technology validated in lab
TRL 5.	technology validated in relevant environment (industrially relevant environment in the case of key enabling technologies)
TRL 6.	technology demonstrated in relevant environment (industrially relevant environment in the case of key enabling technologies)
TRL 7.	system prototype demonstration in operational environment
TRL 8.	system complete and qualified
TRL 9.	actual system proven in operational environment (competitive manufacturing in the case of key enabling technologies)