

# OERA Open Call: Final Report

---

Testing 360 degree imaging technologies for improved animal detection  
around tidal energy installations

Applied Oceans Research Group, Nova Scotia Community College  
March 4<sup>th</sup>, 2020

Prepared by: Larissa Pattison, Amy Serrick and Dr. Craig Brown.

## Executive Summary

This report provides an overview of an investigation in marine animal monitoring technology on floating tidal turbine platforms. Two different 360 degree cameras (Go Pro Fusion and Insta 360 One X) were compared to an acoustic camera (Aris Explorer 3000) to determine which system would be most suitable for marine animal monitoring around Marine Renewable Energy Devices (MRED). The 360 degree cameras were self-contained units that were mounted on Sustainable Marine Energy's PLAT-I. These deployments were conducted in Grand Passage, Nova Scotia, which is part of the Bay of Fundy. Data was collected away from the platform to compare and contrast the differences between the 360 degree and acoustic cameras. Due to a number of logistical challenges, data collection was limited and occurred mainly in the winter months. From the data collected, it is evident that marine life such as small fish and jellyfish are present around the platform but no larger marine fauna was observed during any of the data collection periods. The marine life was never observed to have interacted with the turbines or the platform itself. Successful deployments of the 360 degree cameras allowed simultaneous collection of upstream and downstream data, resulting in a more comprehensive assessment of marine animal interaction with the platform. There was not enough data to effectively compare the efficiency of the 360 degree camera compared to the acoustic camera in this environment, and the acoustic camera was not simultaneously deployed on the PLAT-I at the same time as the 360 degree cameras. Further field trials are recommended, that target deployments while the PLAT-I is fully operational, and with deployments taking place during each season. Technical limitations remain to stream live video data to the surface using these 360 degree cameras, posed by interfacing with off the shelf 360 degree camera models and transmission and storage of data volumes from the 360 degree video. Nonetheless, future modifications to these camera models, or alternative off-the-shelf camera models may make this feasible and cost effective. Logistics for transmission, storage and analysis of 360 degree video still require considerable effort to resolve to make this a routine method for renewable energy devices deployed in the marine environment to monitor marine animal/turbine interactions.

## Table of Contents

<b>PROJECT OBJECTIVES .....</b>	<b>1</b>
<b>METHODOLOGY .....</b>	<b>2</b>
<b>SITE ASSESSMENT AND PLACEMENT OF CAMERA SYSTEMS ON SME PLAT-I .....</b>	<b>2</b>
<b>REDESIGN OF 360° SUBSEA PRESSURE HOUSING.....</b>	<b>3</b>
<b><i>IN SITU</i> CAMERA TRIALS ON PLAT-I .....</b>	<b>3</b>
<b>DATA PROCESSING OF IMAGERY.....</b>	<b>4</b>
<b>KEY FINDINGS AND OUTCOMES .....</b>	<b>5</b>
<b>SITE ASSESSMENT AND PLACEMENT OF CAMERA SYSTEMS ON SME PLAT-I .....</b>	<b>5</b>
<b>REDESIGN OF 360° SUBSEA PRESSURE HOUSING.....</b>	<b>6</b>
<b><i>IN SITU</i> CAMERA TRIALS ON PLAT-I .....</b>	<b>8</b>
<b>DATA PROCESSING OF IMAGERY.....</b>	<b>10</b>
<b>CONCLUSION AND IMPACT .....</b>	<b>12</b>
<b>RECOMMENDATIONS AND FUTURE CONSIDERATIONS.....</b>	<b>13</b>
<b>APPENDIX A .....</b>	<b>14</b>
<b>APPENDIX B .....</b>	<b>18</b>

Table 1 360 Degree Camera Deployment Data .....	8
Figure 1 Proposed Mounting Locations for 360 Camera Systems.....	2
Figure 2 Go Pro Fusion System Attached to Scaffolding Pole in Preparation to be Mounted to the PLAT-I .....	3
Figure 3 Location A (Top) vs Location B (Bottom) for Turbine Visualization during Deployments These figures are still images of the 360 video spread into a flat image. The silver borders are the inside of the pressure housing. ....	5
Figure 4 Go Pro Fusion Pressure Housing Design .....	6
Figure 5 Insta 360 One X Pressure Housing Design .....	7
Figure 6 Poor Resolution Caused by Insta 360 One X Lenses not Centered in Dome Ports. In the bottom of the frame, the image is distorted, there is a reflection on the dome port from the inside of the housing, which is caused by the camera not being centred.....	7
Figure 7.1 Acoustic Camera Still of Bubble Plume Caused by Flooded Buoy .....	9
Figure 7.2 Insta 360 One X Still of Bubble Plume Caused by Flooded Buoy .....	10
Figure 8 Still image of Marine Animal near the PLAT. Please refer to Table 2 in Appendix B for more detailed information on each still.....	11

## Project Objectives

The aim of this project was to explore camera systems that will improve in situ monitoring of marine animal interactions with turbine blades of tidal energy platforms. 360 degree camera systems deployed in pressure housings designed by the Applied Oceans Research Group (AORG) collected imagery alongside the Aris Explorer 3000 acoustic camera in the upper 15m of the water column. These camera systems were mounted on Sustainable Marine Energy (SME) PLAT-I floating tidal turbine. The data collected was analyzed to compare and contrast the benefits and limitations of each camera system in this specific environment.

The project objectives were to:

- 1) Modify the existing NSCC AORG 360 degree prototype camera system for installation onto the SME PLAT-I MRED. This will include design modifications to power the camera directly from the platform, and allow data transfer from the subsea camera to the surface via a cable.
- 2) Testing different installation locations on the platform to optimize field of view, available ambient light and minimize adverse environmental characteristics such as presence of bubbles, vibration, or turbidity.
- 3) Installation of the Aris Explorer 3000 acoustic camera adjacent to one of the 360° cameras for direct comparison of performance.
- 4) Testing the cameras over an extended period (~2-4 weeks) to evaluate long term performance and effectiveness in collecting data in a high flow environment.
- 5) Manual assessment of the video footage and data from the Aris Explorer 3000 acoustic camera to determine the effectiveness of these technologies for in situ monitoring of MREDs.

## Methodology

### Site assessment and placement of camera systems on SME Plat-I

A site visit of the SME PLAT-I was done to assess options for camera placements. In order to evaluate possible mounting locations a Go Pro Hero was used to take underwater video. The video was reviewed and two mounting locations were decided based on ambient light, turbidity and field of view in relation to the turbine (Figure 1). A mounting location for the ARIS Explorer 3000 was also considered as it would have ideally been mounted next to one of the 360 degree cameras for accurate comparison of the collected data.

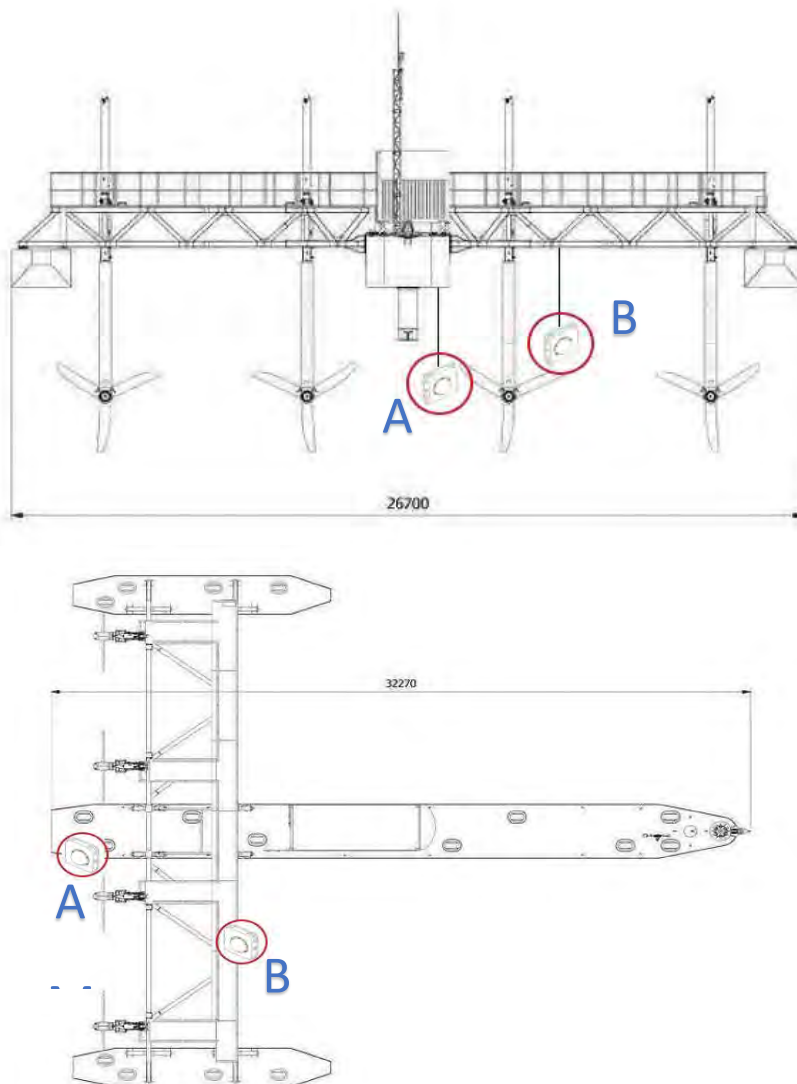

Figure 1 Proposed Mounting Locations for 360 Camera Systems.

## Redesign of 360° subsea pressure housing

The 360 degree camera housing made for a Go Pro Fusion was redesigned in order to accommodate an adapter for a pole mount. For logistical reasons at this proof of concept stage, the camera systems were designed as self-contained units using an internal battery and large capacity micro SD cards within the subsea pressure housings to collect the imagery, rather than attempting to power the units from the surface.

Bench testing at NSCC facilities was done on the Go Pro Fusion. Both the in air and in tank tests revealed that the Go Pro would overheat and shut down in approximately one hour while shooting in full resolution video. Due to the overheating issues in the Go Pro Fusion system, the Insta 360 One X was purchased and a new underwater pressure housing was designed to accommodate the new camera system. Both of these pressure housings were designed using Autodesk Inventor 2019. Please refer to Appendix A for the pressure housing designs.

## *In situ* camera trials on PLAT-I

The 360° cameras were deployed either individually or two at a time during daylight hours. The cameras would record between 3 to 8 hours depending on storage capacity of the microSD cards. While using the Go Pro Fusion systems the cameras used video time-lapse settings at varied intervals (0.5s, 1s, 5s, 10s, 30s and 60s) to combat the overheating issue. The cameras were deployed by the SME crew, the pressure housings were attached to a scaffolding pole using a pole adapter and using scaffolding clamps, the pole was secured to the beams on the PLAT-I. The cameras were recovered to swap out the battery and memory card for redeployment.



*Figure 2 Go Pro Fusion System Attached to Scaffolding Pole in Preparation to be Mounted to the PLAT-I.*

A few limiting factors prevented the Aris Explorer 3000 from being mounted on the PLAT-I, these factors are discussed more in the Key Findings and Impact section. Because of these factors, members of SOAR and NSCC deployed the Aris Explorer 3000 and the Insta 360 One X off the Grand Adventure research vessel in Grand Passage, NS, in order to compare the performance of these systems in a specific environment. Data was collected in a relatively stationary environment while being tied up to the Brier Island wharf and also in a dynamic environment while drifting in the passage. A buoy tied to a weighted sack was used as a target, after initial data collection, the buoy was intentionally flooded and submerged, producing an additional target of a bubble plume.

## Data processing of imagery

The deployment videos were rendered using the appropriate software. The Go Pro videos were rendered in 2k using the Fusion studio software and the Insta 360 videos were rendered in full resolution using the Insta 360 studio software. Once rendered, the videos were reviewed for any marine animals by a single observer in Adobe Premiere. When a marine animal was spotted, a marker was placed, a still image was taken and a red box outlining the marine animal was placed on the still. An approximate time and tidal state was noted for each still image of the marine animal.



## Key Findings and Outcomes

### Site assessment and placement of camera systems on SME Plat-I

Cameras deployed in location A (Figure 1) produced much better data in regards to visibility of the turbine blades compared to cameras deployed in location B (Figure 2.1 and 2.2). However, due to the difficult environment conditions it was only possible to deploy cameras at location A during high slack tide, therefore most of the deployments were done at location B. The Aries Explorer 3000 was never mounted on the Plat-I, therefore its placement in regards to the 360 degree cameras was never considered during data collection.

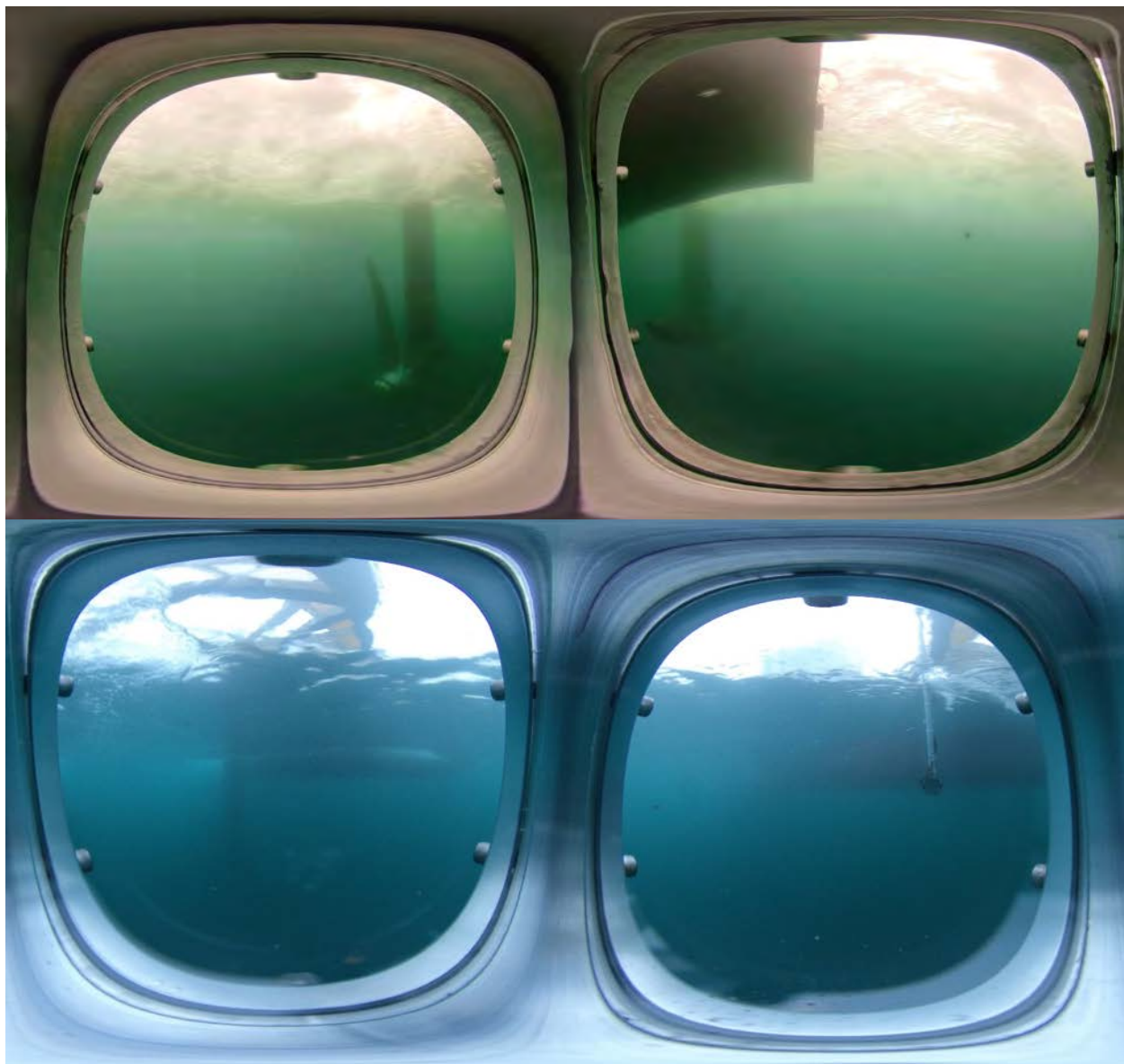

*Figure 3 Location A (Top) vs Location B (Bottom) for Turbine Visualization during Deployments These figures are still images of the 360 video spread into a flat image. The silver borders are the inside of the pressure housing.*

## Redesign of 360° subsea pressure housing

There were only slight modifications done to the previous Go Pro Fusion pressure housing which included a surface adjustment to accommodate a pole adapter needed to deploy the system of the PLAT-I. Also, chamfers were designed to allow water to flow around the case easier, relieving some of the strain on the mounting pole (Figure 3).



*Figure 4 Go Pro Fusion Pressure Housing Design.*

Since the camera design of the Insta 360 One X is different than the Go Pro Fusion, a second camera housing was also designed and fabricated. The housing for the Insta 360 One X is much thinner and used 3-inch dome ports compared to the 4-inch used for the Go Pro. A similar feature was created on the bottom surface of the case, allowing a pole adaptor to be connected so the system could be deployed off the platform (Figure 4). Please refer to Appendix A for more detailed drawings of the pressure housings.



*Figure 5 Insta 360 One X Pressure Housing Design.*

Due to the time constraints of this project, the prototype pressure housing was designed relatively quickly and did not consider mounting options for the camera inside the case. Ultimately, camera movement inside the housing created resolution issues because the camera lenses did not always line up to the centre of the dome ports (Figure 5). This could be easily rectified through minor modifications to the housing in subsequent design iterations.

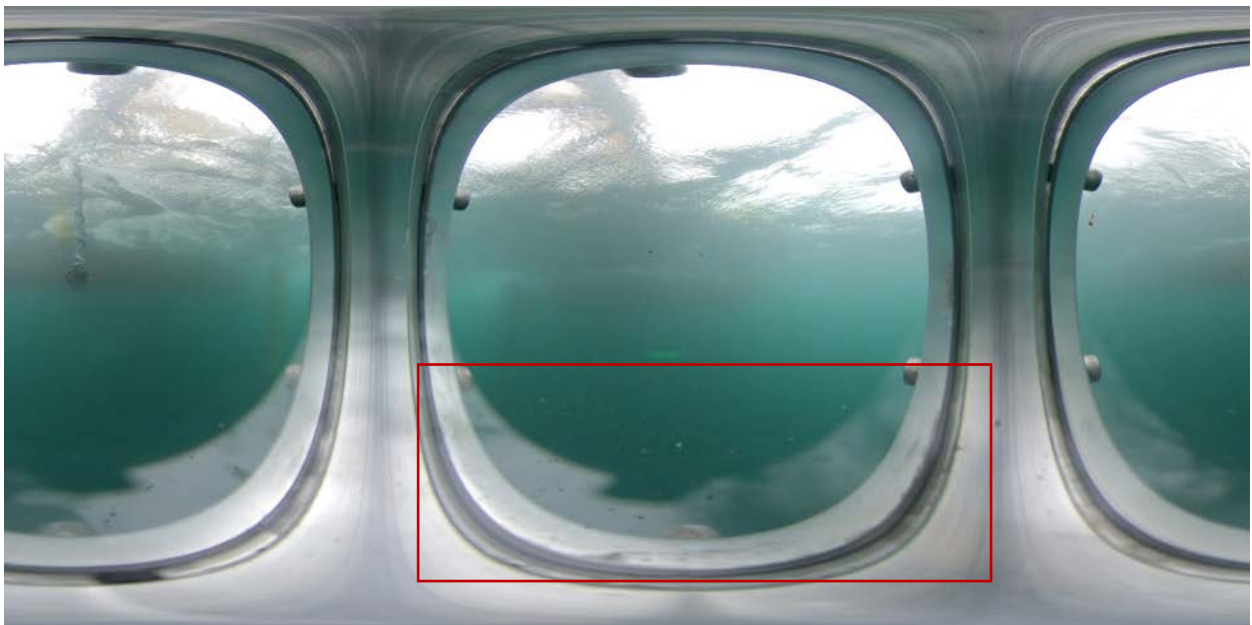

*Figure 6 Poor Resolution Caused by Insta 360 One X Lenses not Centered in Dome Ports. In the bottom of the frame, the image is distorted, there is a reflection on the dome port from the inside of the housing, which is caused by the camera not being centred.*

*In situ* camera trials on PLAT-I

A total of six deployments were completed using the 360 degree cameras, the first two deployments consisted of two Go Pro Fusion camera systems with different video time-lapse intervals. The rest of the deployments were done using one camera, either the Go Pro or the Insta 360. The deployment time, tidal data and a Secchi disk measurement was noted before each deployment (Table 1).

Table 1 360 Degree Camera Deployment Data

Deployment #	Date	Deployment (Local Time)	Tides (Local Time)	Camera Settings	Secchi Disk Measurement	Comments
1	2019/10/03	15:30	High:0314 Low:0930 High:1534 Low:2200	Cam A- 1s Cam B- 5s	~ 8m	First deployment. Helical strakes added to poles. Minimal strumming observed.
2	2019/10/04	10:23	High:0408 Low:1023 High:1629 Low:2255	Cam A- 5s Cam B- 10s	~ 8m	
3	2019/11/20	10:41	High:0450 Low:1109 High:1715 Low:2343	Cam A- 10s	~ 6-8m	Could only deploy one camera due to conditions
4	2020/01/06	10:38	Low:0112 High:0722 Low:1347 High:1952	Insta 360	~ 8m	
5	2020/01/21	11:45	Low:0201 High:0811 Low:1437 High:2049	Cam A- 1s	~ 7m	
6	2020/01/22	10:54	Low:0258 High:0906 Low:1531 High:2143	Insta 360	~ 7m	

Camera A in the first deployment, Camera B in the second deployment and Camera A in deployment 3 were unsuccessful and did not result in useable video data. The cause of this could be speculated as user error since the cameras were in working order for every deployment.

The Aris Explorer 3000 was not able to be mounted to the platform for a multitude of reasons: the mounting bracket necessary for the camera to be deployed off the PLAT-I was robust and when initially machined, it did not fit on the platform properly. Also, SME's involvement in other projects that were using acoustic equipment which prevented the Aris being mounted because it would have interfered with the other acoustic instrumentation. Finally, when the platform was generating, a hydrophone always had to be running, again preventing the acoustic camera from being mounted as it would have interfered with the hydrophone.

Since the acoustic camera was never mounted to the platform, concurrent data with the acoustic and 360 degree cameras was collected off the Grand Adventure research vessel. These data showed the drastic difference in field of views between the two camera systems (Figure 6.1 and 6.2). As expected, the 360 degree camera had a much larger field of view than the acoustic camera. It is also evident from the still images that the resonating bubbles on the acoustic image create a much large image/target than visible on the optical image. Unfortunately, due to the lack of data it is difficult to conclude any other findings on the comparison between these two camera systems.

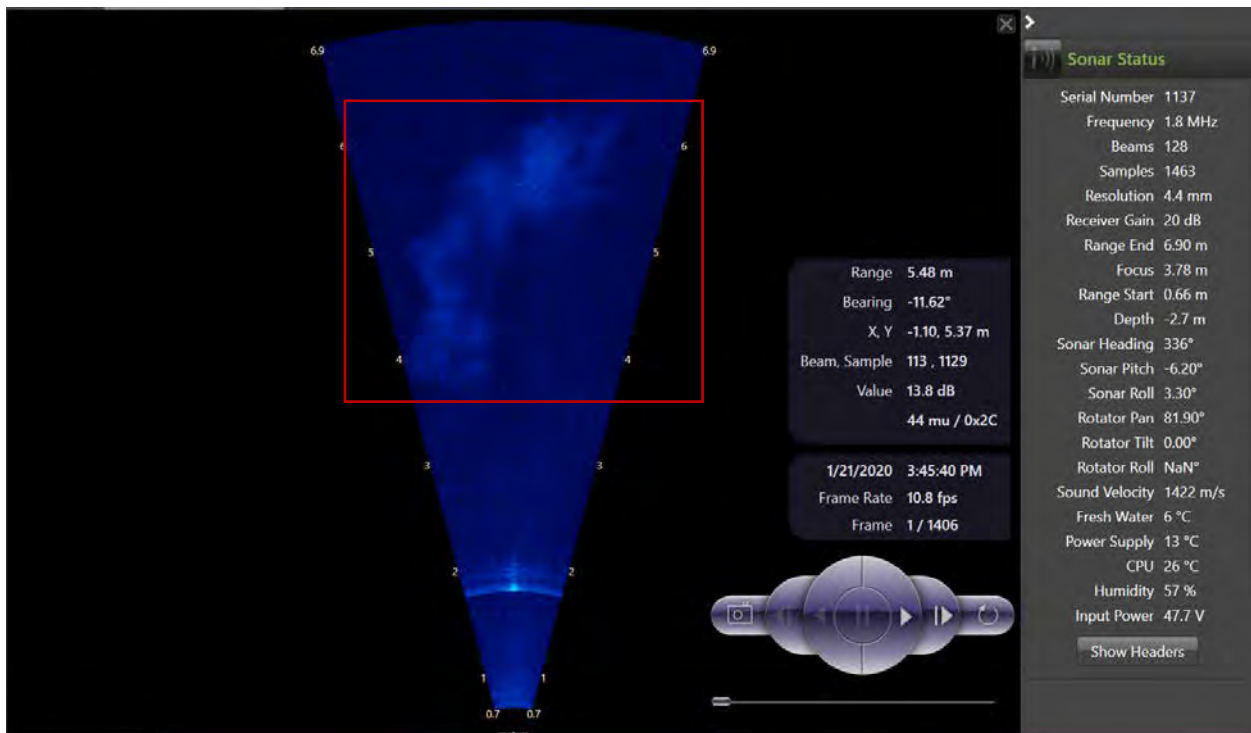

Figure 7.1 Acoustic Camera Still of Bubble Plume Caused by Flooded Buoy.

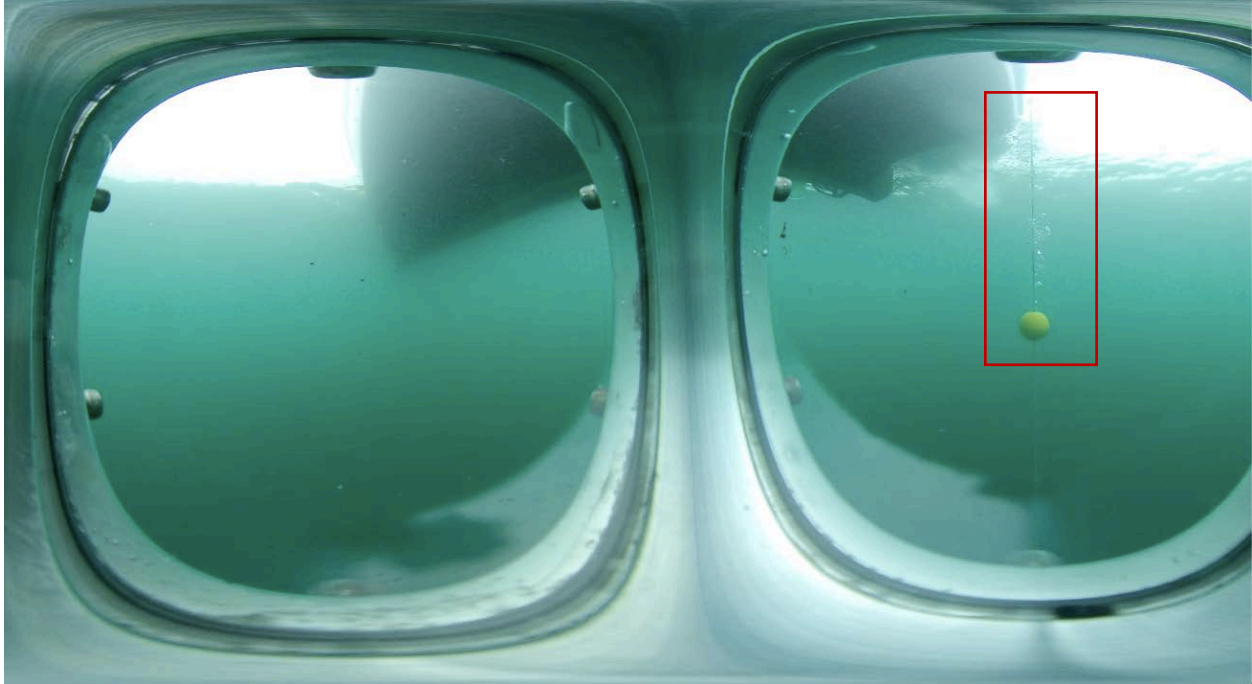
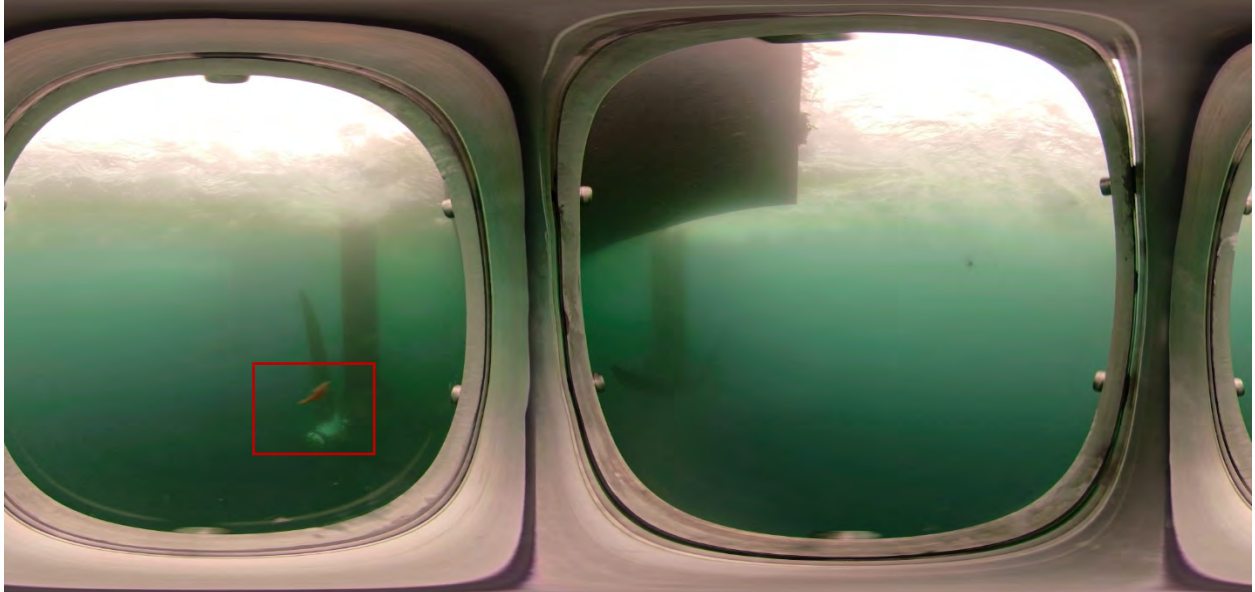

Figure 7.2 Insta 360 One X Still of Bubble Plume Caused by Flooded Buoy.

### Data processing of imagery

Prior to being reviewed, the videos collected needed to be rendered in order for the lenses to be stitched together, providing the 360° view. This process took many hours and often resulted in large file sizes causing the video to be choppy and hard to analyze. The data resulted in clear imagery of platform and the areas upstream and downstream from the platform. After reviewing all of the video data, it is evident that small marine life such as fish and jellyfish are around the platform but no larger marine fauna were observed in the field of view for any of the collected video footage. The animals in the field of view never interacted with the turbines or the platform itself (Figure 7). Please refer to Appendix B to review all still images of marine life noted in the videos. Please refer to Table 2 in Appendix B for more detailed information on each still.

It was difficult to determine whether moving objects in the water were in fact marine animals because of the fast moving water as well as image quality due to motion. After careful consideration, stills were taken of frames that were believed to have the best quality image of the marine animal. It was difficult to identify marine animals in the still images taken from the video because the images were blurry objects and without the ability to scroll to the previous and proceeding frame. Therefore, the observer often had to refer back to the video to confirm marine animal movement.



*Figure 8 Still image of Marine Animal near the PLAT. Please refer to Table 2 in Appendix B for more detailed information on each still.*

## Conclusion and Impact

Overall, this project was successful regarding most of the project objectives but did not meet all expectations. The existing pressure housing for the Go Pro Fusion was effectively modified to accommodate the mounting options of the PLAT-I. Similarly, a new pressure housing was designed to allow the Insta 360 One X to be used during this project – effectively testing alternative choices of off the-shelf 360 degree camera systems. Both camera systems were successfully deployed multiple times off the PLAT-I, allowing simultaneous collection of upstream and downstream data. However, the Aris Explorer 3000 was never mounted on the platform, resulting in a lack of data to compare the pros and cons of the two camera systems in this specific environment. Furthermore, due to unfavourable conditions, there were large time gaps between deployments which prevented the evaluation of performance for these systems during seasonal periods where higher densities of marine fauna could be expected. Nonetheless, the proof-of-concept trials successfully demonstrated the potential capability of 360 degree cameras for monitoring MRED and marine animal interactions.



## Recommendations and Future Considerations

- Between the two camera systems (Go Pro Fusion and Insta 360 One X) the Insta 360 One X is a much better choice for this environment because:
  - It shoots in 5.7K compared to the 5.2K for the Go Pro Fusion
  - It is possible to render the Insta 360 videos in full resolution compared to the Go pro videos which have to be rendered in 2k.
  - While shooting video with higher resolution settings, the Go Pro overheats and shuts down in approximately an hour while the Insta 360 will record until the battery dies or the microSD card is full.
  - In order to capture a larger time frame of data, the Go Pro has to be used in time-lapse video mode
- The cameras should be set to shoot in higher frames per second as fast moving objects were quite blurry in the video.
- A way to measure objects in the water column should be incorporated into these systems. It would need to consider the distortion caused by the camera lenses as well as the water.
- Memory cards with high writing speeds (minimum v30) are necessary for these systems.
- This project should be done all year long or for a period during each season of the year to see how the weather affects the data (ex. Species migration)
- Data analysis needs to be automated as it is unrealistic to have a single observer reviewing all data over longer periods of time.
  - Perhaps using artificial intelligence
- The file sizes of the raw footage and the rendered videos are extremely large and requires too much storage to keep multiple days' worth of data.
- More concurrent data needs to be collected with the acoustic and 360 degree cameras to effectively compare the pros and cons of each system in this specific environment.
- It is only possible to live stream the video from the Go Pro Fusion to the surface using a Wi-Fi extension cable for 2.4GHz Wi-Fi. However, this only allows the user to see the video through the mobile app and it would need to be connected prior to deployment. This feature would not allow for data transfer, just the control of the system and live footage at the surface. Neither camera supports controlling via the USB connector.

# Appendix A

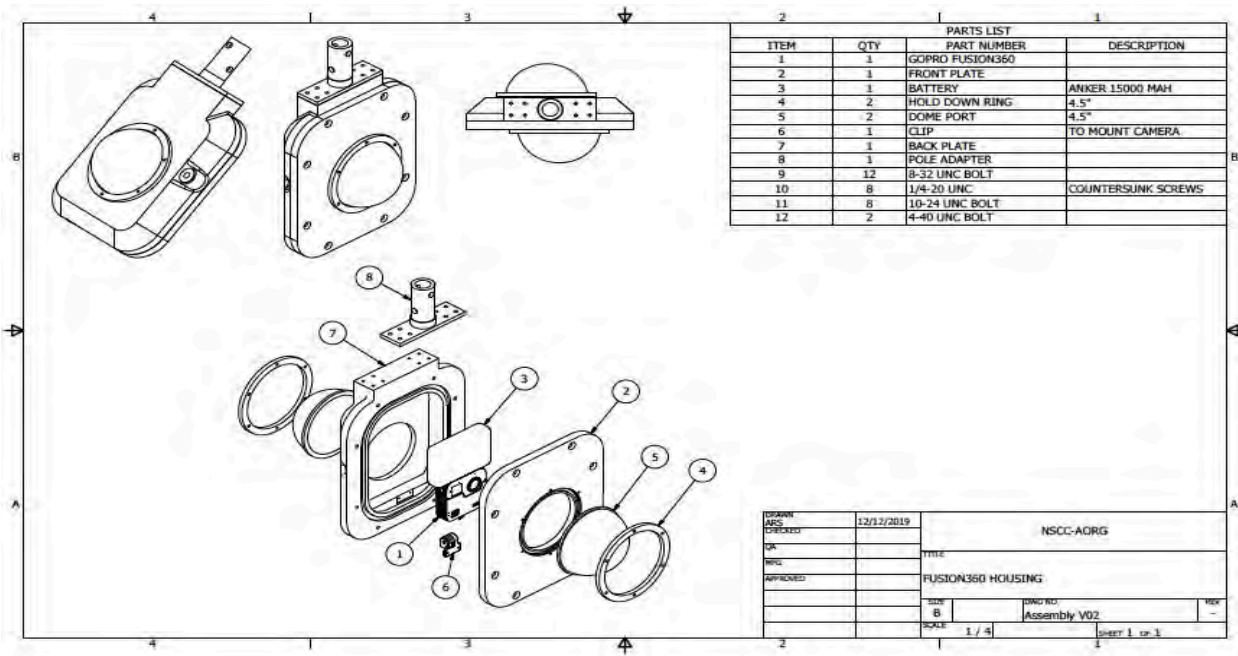

Appendix A 1 Go Pro Fusion Assembly.

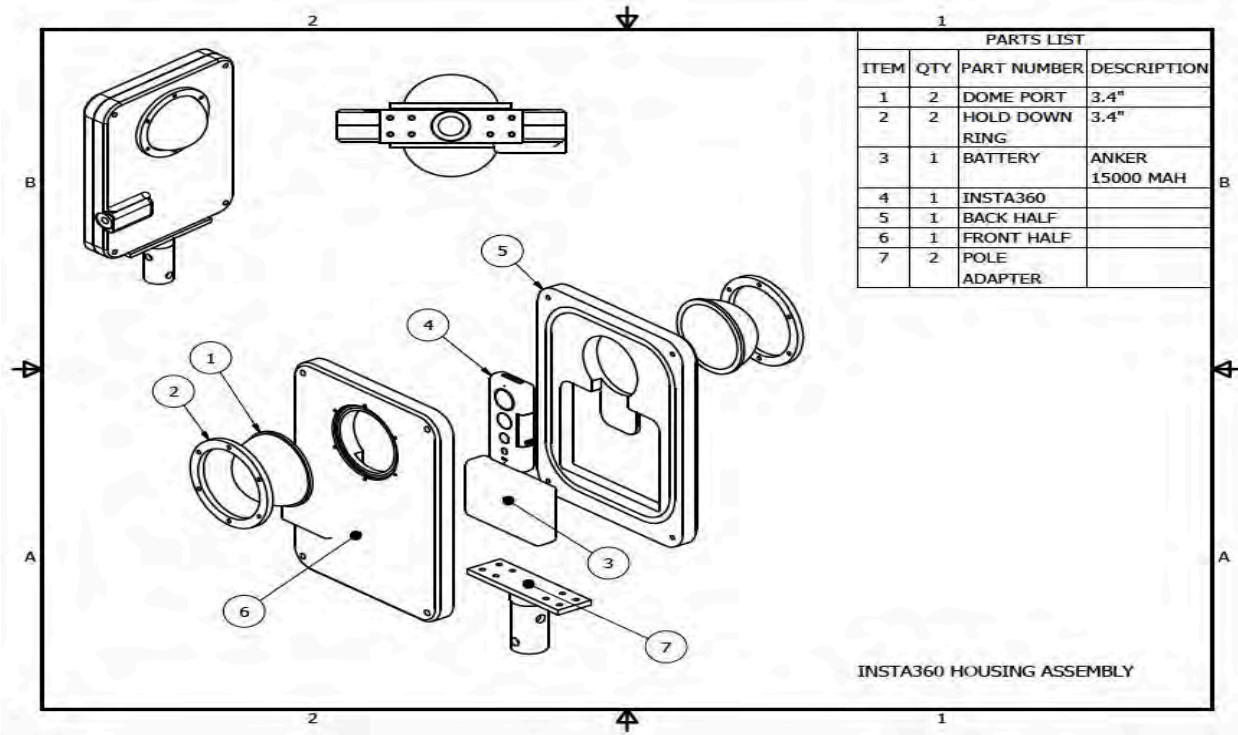

Appendix A 2 Insta 360 One X Assembly.

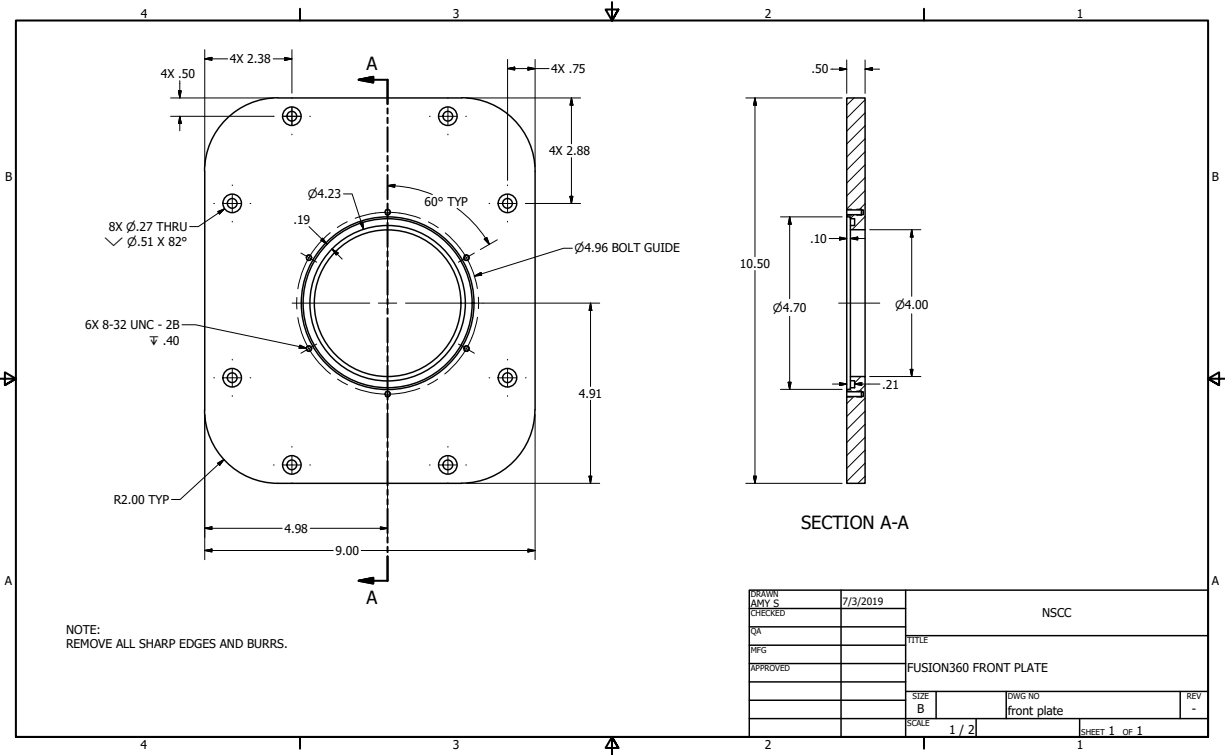

Appendix A 3 Go Pro Fusion Front Plate.

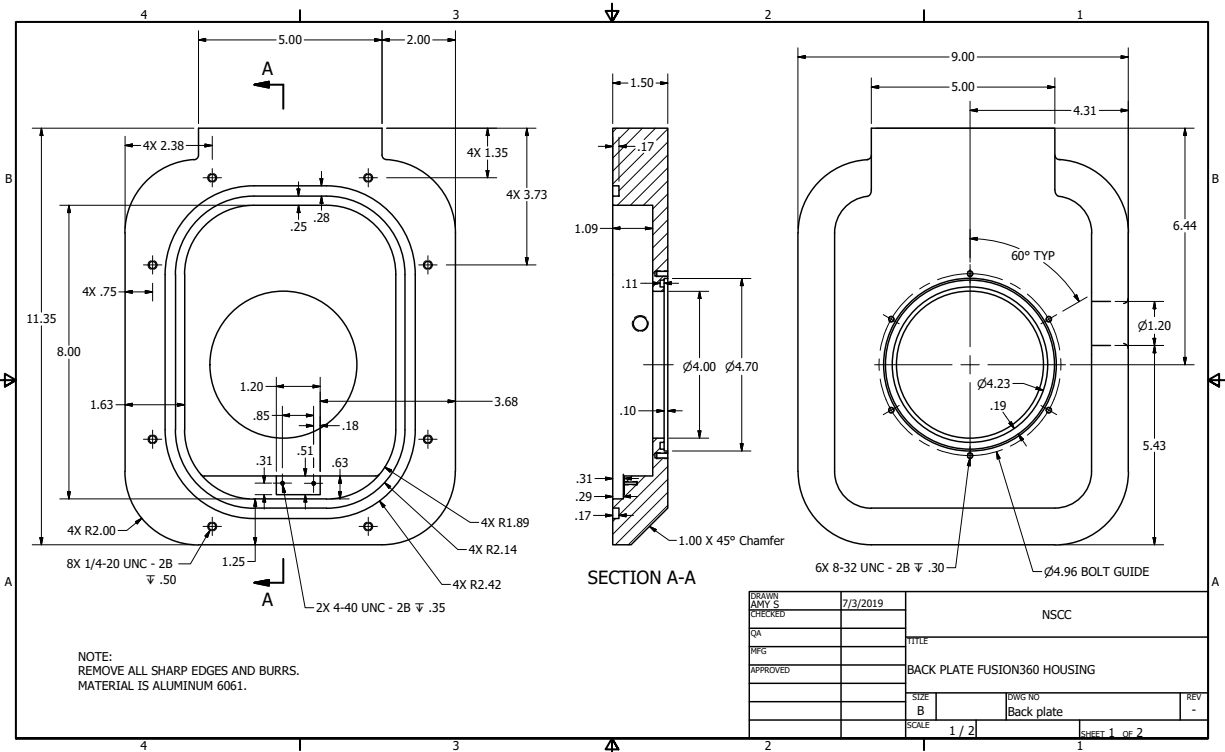

Appendix A 4 Go Pro Fusion Back Plate (1).

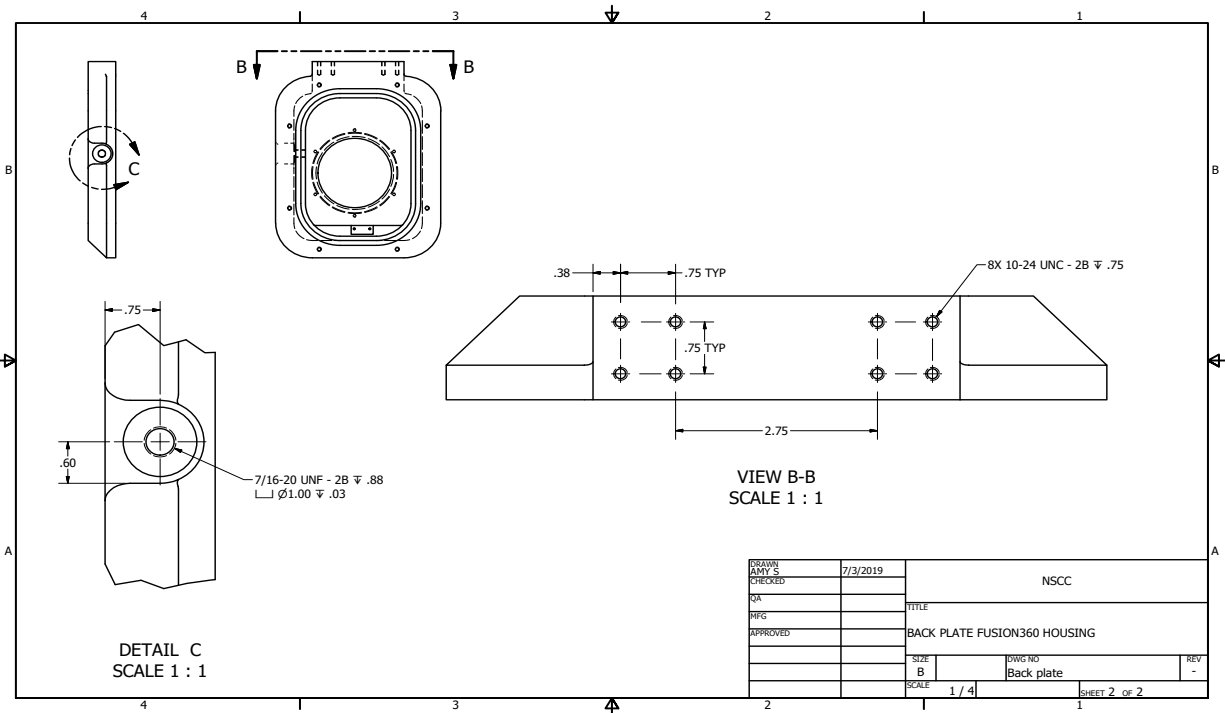

Appendix A 5 Go Pro Fusion Back Plate (2).

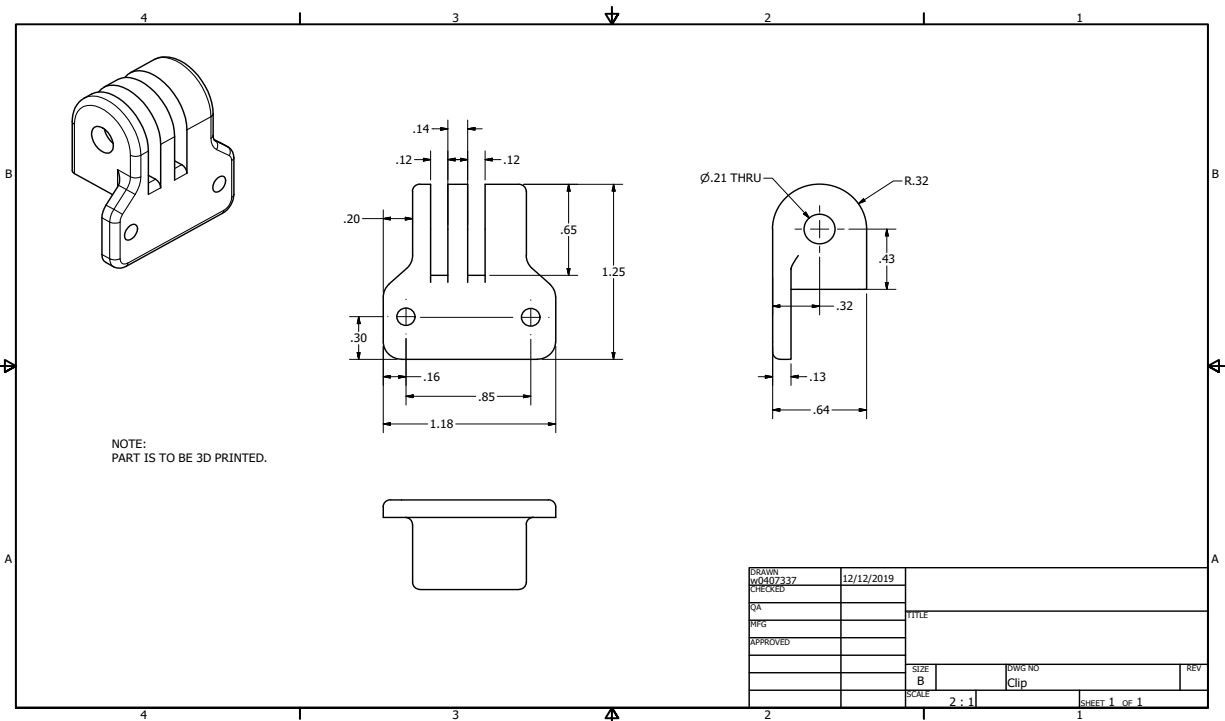

Appendix A 6 Go Pro Fusion Interior Camera Clip.

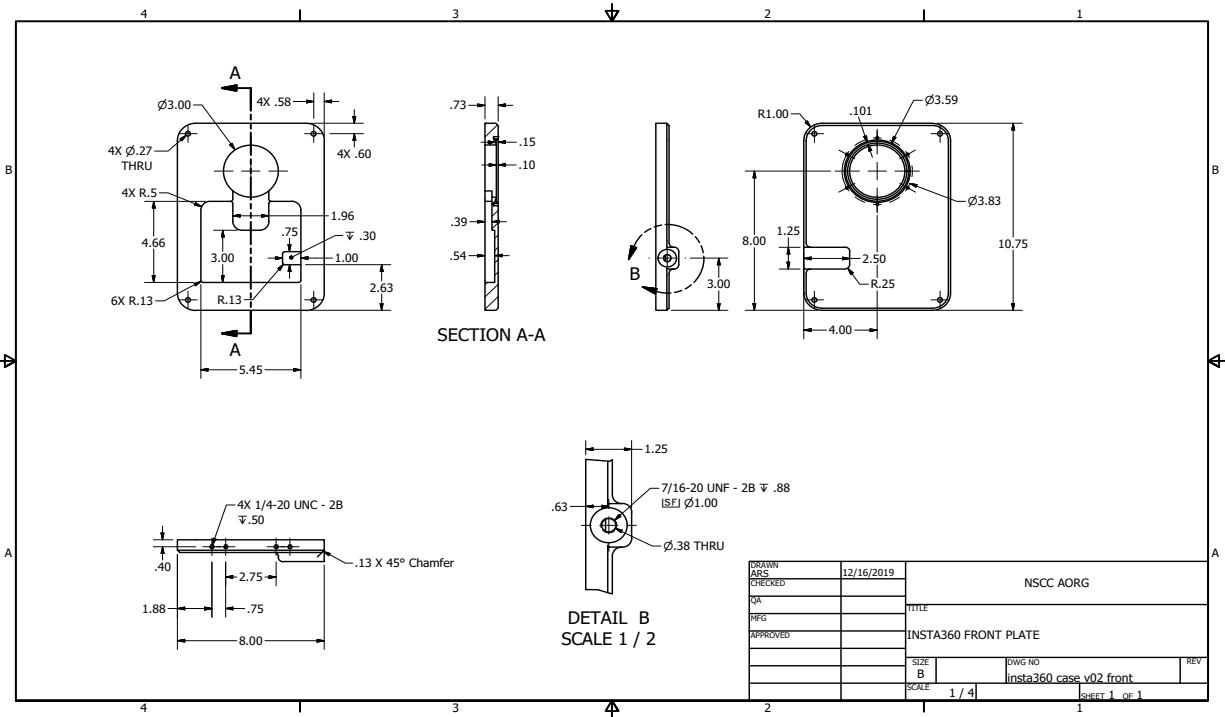

Appendix A 7 Insta 360 One X Front Plate.

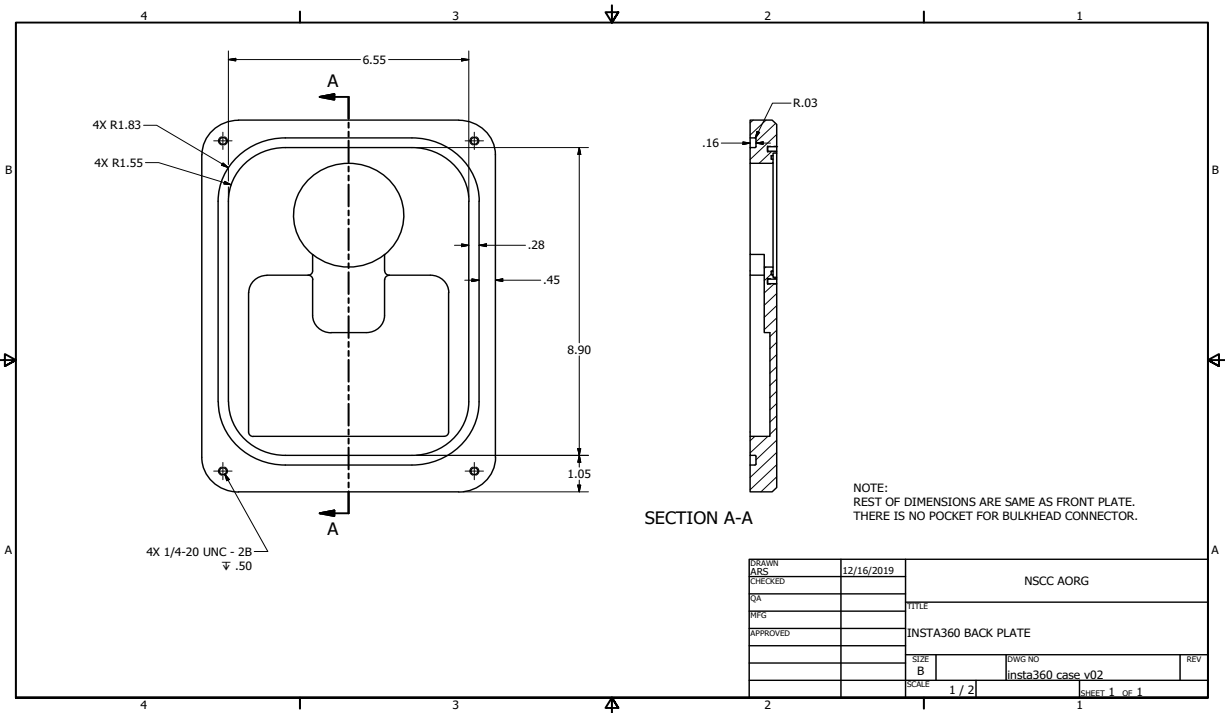

Appendix A 8 Go Pro Fusion Back Plate.

## Appendix B

Table 2 Detailed Information for Each Still taken from Deployment Video.

Deployment #	Deployment Date	Still #	Camera System	Time Elapsed (Video)	Approximate Time of Day	Approximate Tide Elevation (m)
1	2019/10/03	001	Go Pro Fusion	00:01:29:29	15:31	-0.0702
1	2019/10/03	002	Go Pro Fusion	00:01:55:26	15:31	-0.0702
1	2019/10/03	003	Go Pro Fusion	00:02:28:29	15:32	-0.0702
1	2019/10/03	004	Go Pro Fusion	00:03:04:09	15:33	0.0306
1	2019/10/03	005	Go Pro Fusion	00:03:11:21	15:33	0.0306
1	2019/10/03	006	Go Pro Fusion	00:03:11:29	15:33	0.0306
1	2019/10/03	007	Go Pro Fusion	00:03:22:17	15:33	0.0306
1	2019/10/03	008	Go Pro Fusion	00:03:34:18	15:33	0.0306
1	2019/10/03	009	Go Pro Fusion	00:06:02:03	15:36	0.1313
2	2019/10/04	001	Go Pro Fusion	00:06:04:03	10:29	-1.9227
2	2019/10/04	002	Go Pro Fusion	00:06:15:02	10:29	-1.9227
2	2019/10/04	003	Go Pro Fusion	00:07:43:10	10:30	-1.9227
2	2019/10/04	004	Go Pro Fusion	00:08:15:25	10:31	-1.9227
2	2019/10/04	005	Go Pro Fusion	00:08:20:22	10:31	-1.9227
2	2019/10/04	006	Go Pro Fusion	00:08:22:07	10:31	-1.9227
2	2019/10/04	007	Go Pro Fusion	00:08:27:27	10:31	-1.9227
2	2019/10/04	008	Go Pro Fusion	00:08:38:07	10:31	-1.9227
2	2019/10/04	009	Go Pro Fusion	00:08:50:03	10:31	-1.9227

2	2019/10/04	010	Go Pro Fusion	00:10:24:02	10:33	-1.8599
2	2019/10/04	011	Go Pro Fusion	00:10:35:13	10:33	-1.8599
2	2019/10/04	012	Go Pro Fusion	00:12:05:02	10:35	-1.8599
2	2019/10/04	013	Go Pro Fusion	00:12:06:27	10:35	-1.8599
2	2019/10/04	014	Go Pro Fusion	00:12:11:06	10:35	-1.8599
2	2019/10/04	015	Go Pro Fusion	00:13:12:29	10:36	-1.8599
2	2019/10/04	016	Go Pro Fusion	00:13:14:10	10:36	-1.8599
2	2019/10/04	017	Go Pro Fusion	00:14:07:04	10:37	-1.8599
2	2019/10/04	018	Go Pro Fusion	00:16:14:22	10:39	-1.7936
2	2019/10/04	019	Go Pro Fusion	00:16:17:03	10:39	-1.7936
2	2019/10/04	020	Go Pro Fusion	00:16:22:24	10:39	-1.7936
2	2019/10/04	021	Go Pro Fusion	00:16:44:23	10:39	-1.7936
2	2019/10/04	022	Go Pro Fusion	00:17:45:05	10:40	-1.7936
2	2019/10/04	023	Go Pro Fusion	00:21:38:16	10:44	-1.7240
2	2019/10/04	024	Go Pro Fusion	00:25:51:15	10:48	-1.6510
2	2019/10/04	025	Go Pro Fusion	00:26:09:11	10:49	-1.6510
2	2019/10/04	026	Go Pro Fusion	00:28:03:27	10:51	-1.6510
2	2019/10/04	027	Go Pro Fusion	00:29:22:25	10:51	-1.6510
2	2019/10/04	028	Go Pro Fusion	00:30:38:18	10:52	-1.6510
2	2019/10/04	029	Go Pro Fusion	00:30:56:12	10:52	-1.6510
2	2019/10/04	030	Go Pro Fusion	00:30:58:13	10:52	-1.6510

2	2019/10/04	031	Go Pro Fusion	00:35:57:28	10:57	-1.5749
2	2019/10/04	032	Go Pro Fusion	00:41:55:29	11:03	-1.4139
2	2019/10/04	033	Go Pro Fusion	00:46:45:02	11:08	-1.3293
2	2019/10/04	034	Go Pro Fusion	00:48:13:18	11:10	-1.3293
2	2019/10/04	035	Go Pro Fusion	00:51:19:15	11:13	-1.2420
2	2019/10/04	036	Go Pro Fusion	01:00:48:10	11:22	-1.1524
2	2019/10/04	037	Go Pro Fusion	01:02:19:20	11:24	-1.0605
2	2019/10/04	038	Go Pro Fusion	01:14:52:29	11:36	-0.8706
2	2019/10/04	039	Go Pro Fusion	01:30:16:00	11:52	-0.5731
2	2019/10/04	040	Go Pro Fusion	01:37:11:03	11:59	-0.3683
2	2019/10/04	041	Go Pro Fusion	01:37:31:20	11:59	-0.3683
2	2019/10/04	042	Go Pro Fusion	01:40:30:08	12:03	-0.2645
2	2019/10/04	043	Go Pro Fusion	01:40:32:24	12:03	-0.2645
2	2019/10/04	044	Go Pro Fusion	01:40:56:20	12:03	-0.2645
2	2019/10/04	045	Go Pro Fusion	01:41:16:03	12:04	-0.2645
2	2019/10/04	046	Go Pro Fusion	01:42:02:29	12:05	-0.2645
2	2019/10/04	047	Go Pro Fusion	01:42:24:22	12:05	-0.2645
2	2019/10/04	048	Go Pro Fusion	01:44:05:06	12:07	-0.2645
2	2019/10/04	049	Go Pro Fusion	01:50:08:23	12:13	-0.0550
2	2019/10/04	050	Go Pro Fusion	01:52:41:08	12:15	-0.0550
2	2019/10/04	051	Go Pro Fusion	02:05:13:09	12:28	0.2610



2	2019/10/04	052	Go Pro Fusion	02:09:00:12	12:32	0.2610
2	2019/10/04	053	Go Pro Fusion	02:13:46:05	12:36	0.3661
2	2019/10/04	054	Go Pro Fusion	02:14:10:09	12:37	0.3661
2	2019/10/04	055	Go Pro Fusion	02:58:05:11	13:21	1.2706
2	2019/10/04	056	Go Pro Fusion	03:00:16:15	13:23	1.3632
2	2019/10/04	057	Go Pro Fusion	03:01:46:15	13:24	1.3632
2	2019/10/04	058	Go Pro Fusion	03:02:54:06	13:25	1.3632
2	2019/10/04	059	Go Pro Fusion	03:03:37:05	13:26	1.3632
2	2019/10/04	060	Go Pro Fusion	03:04:42:22	13:27	1.3632
2	2019/10/04	061	Go Pro Fusion	03:04:43:27	13:27	1.3632
2	2019/10/04	062	Go Pro Fusion	03:04:46:08	13:27	1.3632
2	2019/10/04	063	Go Pro Fusion	03:04:58:14	13:27	1.3632
2	2019/10/04	064	Go Pro Fusion	03:11:03:10	13:34	1.5417
2	2019/10/04	065	Go Pro Fusion	03:12:44:05	13:35	1.5417
2	2019/10/04	066	Go Pro Fusion	03:13:22:03	13:36	1.5417
2	2019/10/04	067	Go Pro Fusion	03:13:37:09	13:36	1.5417
2	2019/10/04	068	Go Pro Fusion	03:13:50:04	13:36	1.5417
2	2019/10/04	069	Go Pro Fusion	03:13:58:19	13:36	1.5417
2	2019/10/04	070	Go Pro Fusion	03:14:10:15	13:37	1.5417
2	2019/10/04	071	Go Pro Fusion	03:14:55:16	13:37	1.5417
2	2019/10/04	072	Go Pro Fusion	03:15:07:08	13:38	1.6273

2	2019/10/04	073	Go Pro Fusion	03:16:47:15	13:39	1.6273
2	2019/10/04	074	Go Pro Fusion	03:25:34:21	13:48	1.7903
2	2019/10/04	075	Go Pro Fusion	03:26:29:20	13:49	1.7903
2	2019/10/04	076	Go Pro Fusion	03:27:30:23	13:50	1.7903
2	2019/10/04	077	Go Pro Fusion	03:35:31:27	13:58	1.9415
2	2019/10/04	078	Go Pro Fusion	03:54:39:13	14:17	2.1439
2	2019/10/04	079	Go Pro Fusion	04:22:19:13	14:45	2.4496
2	2019/10/04	080	Go Pro Fusion	04:23:00:13	14:46	2.4496
2	2019/10/04	081	Go Pro Fusion	04:25:23:15	14:48	2.4865
2	2019/10/04	082	Go Pro Fusion	04:31:36:02	14:54	2.5194
2	2019/10/04	083	Go Pro Fusion	04:34:16:29	14:57	2.5194
2	2019/10/04	084	Go Pro Fusion	04:39:02:12	15:02	2.5479
2	2019/10/04	085	Go Pro Fusion	04:51:51:07	15:14	2.6077
4	2020/01/06	001	Insta 360 One X	00:00:25:03	10:38	2.0654
4	2020/01/06	002	Insta 360 One X	00:00:26:17	10:38	2.0654
4	2020/01/06	003	Insta 360 One X	00:03:29:18	10:41	2.0654
4	2020/01/06	004	Insta 360 One X	00:03:38:14	10:41	2.0654
4	2020/01/06	005	Insta 360 One X	00:05:43:24	10:43	2.0134

4	2020/01/06	006	Insta 360 One X	00:08:12:16	10:46	2.0134
4	2020/01/06	007	Insta 360 One X	00:15:50:17	10:53	1.8989
4	2020/01/06	008	Insta 360 One X	00:16:24:05	10:54	1.8989
4	2020/01/06	009	Insta 360 One X	00:16:54:07	10:54	1.8989
4	2020/01/06	010	Insta 360 One X	00:28:01:23	11:06	1.7708
4	2020/01/06	011	Insta 360 One X	00:37:01:29	11:15	1.6302
4	2020/01/06	012	Insta 360 One X	00:37:03:11	11:15	1.6302
4	2020/01/06	013	Insta 360 One X	00:37:27:10	11:15	1.6302
4	2020/01/06	014	Insta 360 One X	00:37:28:29	11:15	1.6302
4	2020/01/06	015	Insta 360 One X	01:01:52:03	11:39	1.2303
4	2020/01/06	016	Insta 360 One X	01:16:38:01	11:54	0.9630
4	2020/01/06	017	Insta 360 One X	01:28:17:15	12:06	0.7759
4	2020/01/06	018	Insta 360 One X	01:33:52:16	12:11	0.6803
4	2020/01/06	019	Insta 360 One X	01:34:19:10	12:12	0.6803

4	2020/01/06	020	Insta 360 One X	01:40:00:25	12:18	0.4855
4	2020/01/06	021	Insta 360 One X	01:52:07:08	12:30	0.2873
4	2020/01/06	022	Insta 360 One X	01:58:26:20	12:36	0.1873
4	2020/01/06	023	Insta 360 One X	02:06:35:07	12:44	-0.0135
5	2020/01/21	001	Go Pro Fusion	00:04:54:03	11:49	-1.0443
5	2020/01/21	002	Go Pro Fusion	00:07:39:02	11:52	-1.0443
5	2020/01/21	003	Go Pro Fusion	00:07:59:12	11:52	-1.0443
5	2020/01/21	004	Go Pro Fusion	00:08:00:01	11:53	-1.1336
5	2020/01/21	005	Go Pro Fusion	00:10:14:08	11:55	-1.1336
6	2020/01/22	001	Insta 360 One X	00:19:03:18	12:13	-0.5640
6	2020/01/22	002	Insta 360 One X	00:22:21:06	12:16	-0.5640
6	2020/01/22	003	Insta 360 One X	00:54:39:06	12:48	-1.2127
6	2020/01/22	004	Insta 360 One X	00:57:06:08	12:51	-1.2127
6	2020/01/22	005	Insta 360 One X	00:59:50:13	12:59	-1.3811
6	2020/01/22	006	Insta 360 One X	01:00:22:03	13:00	-1.3811
6	2020/01/22	007	Insta 360 One X	01:02:23:05	13:02	-1.3811

6	2020/01/22	008	Insta 360 One X	01:05:42:04	13:05	-1.4617
6	2020/01/22	009	Insta 360 One X	01:06:14:16	13:06	-1.4617
6	2020/01/22	010	Insta 360 One X	01:08:39:26	13:08	-1.5396
6	2020/01/22	011	Insta 360 One X	01:13:14:09	13:13	-1.6149
6	2020/01/22	012	Insta 360 One X	01:16:31:19	13:16	-1.6149
6	2020/01/22	013	Insta 360 One X	01:16:55:17	13:16	-1.6149
6	2020/01/22	014	Insta 360 One X	01:31:54:01	13:31	-1.8229



*Appendix B Deployment 1 Still 001.*

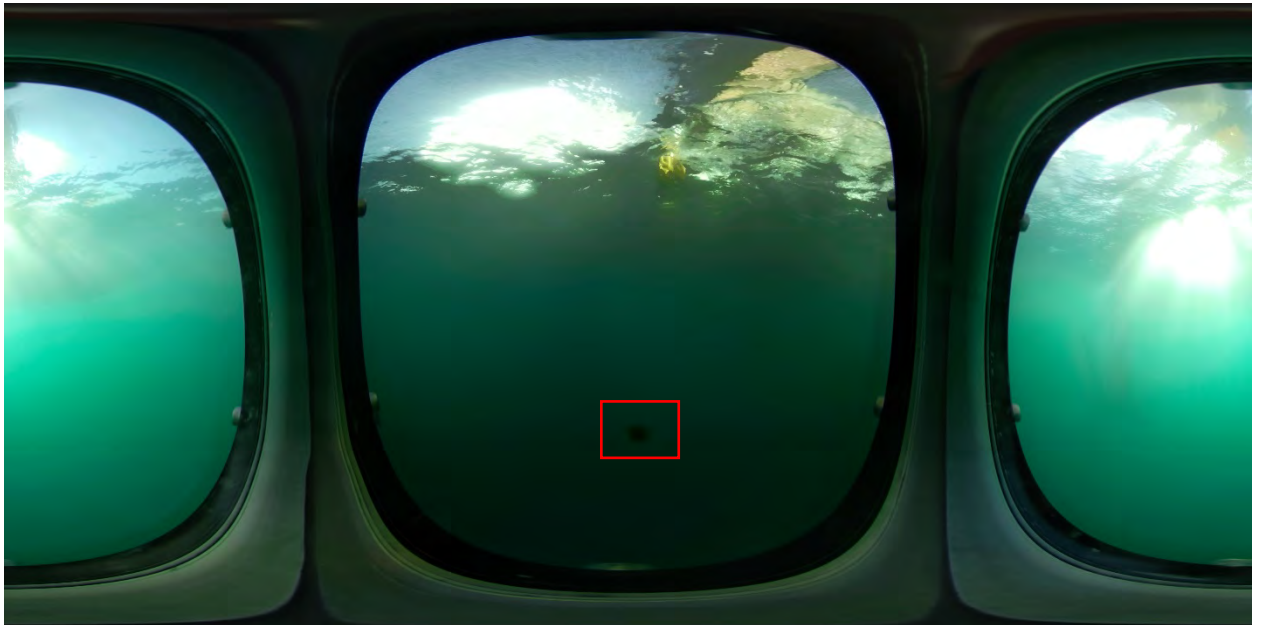

*Appendix B Deployment 1 Still 002.*

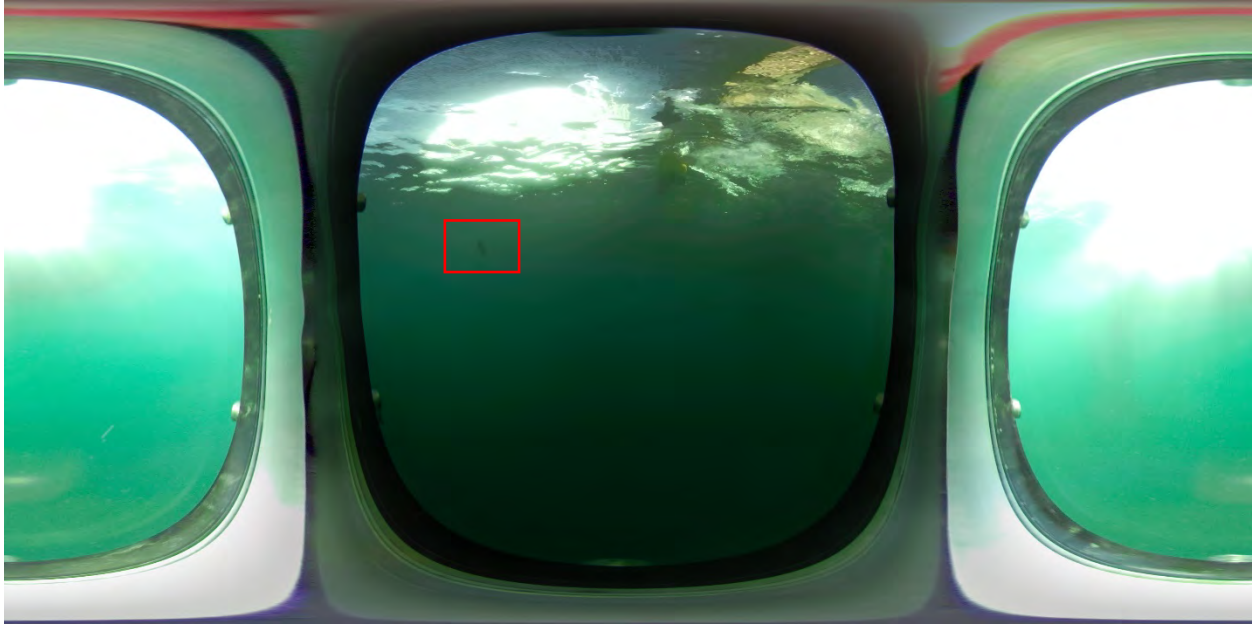

*Appendix B Deployment 1 Still 003.*

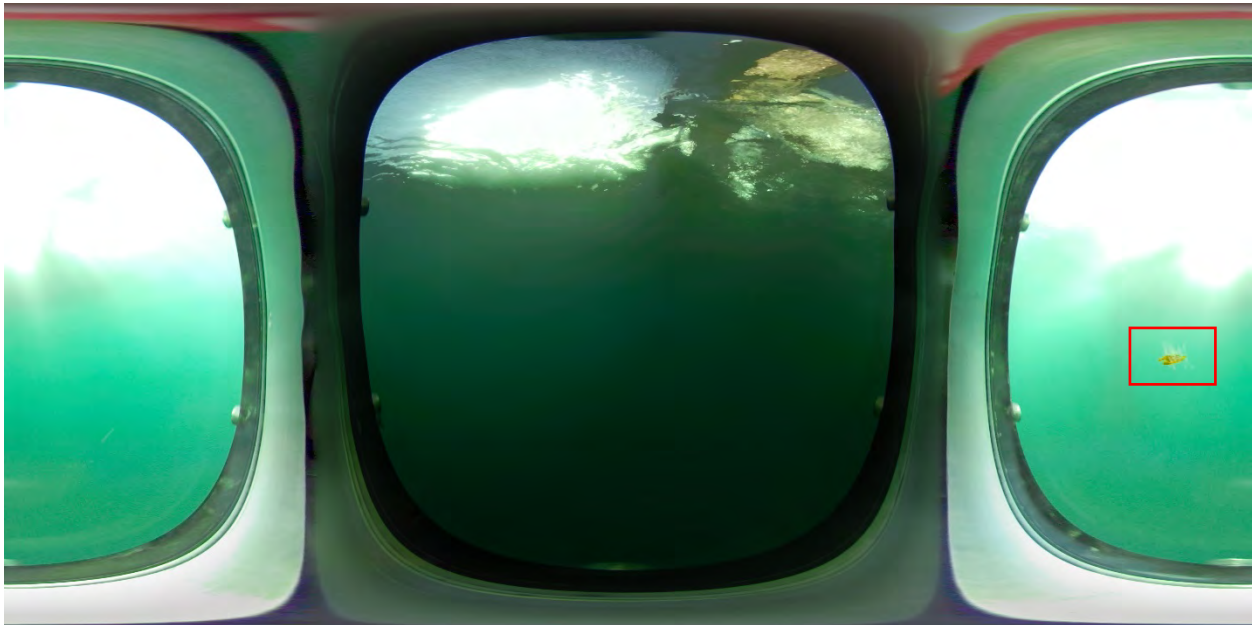

*Appendix B Deployment 1 Still 004.*

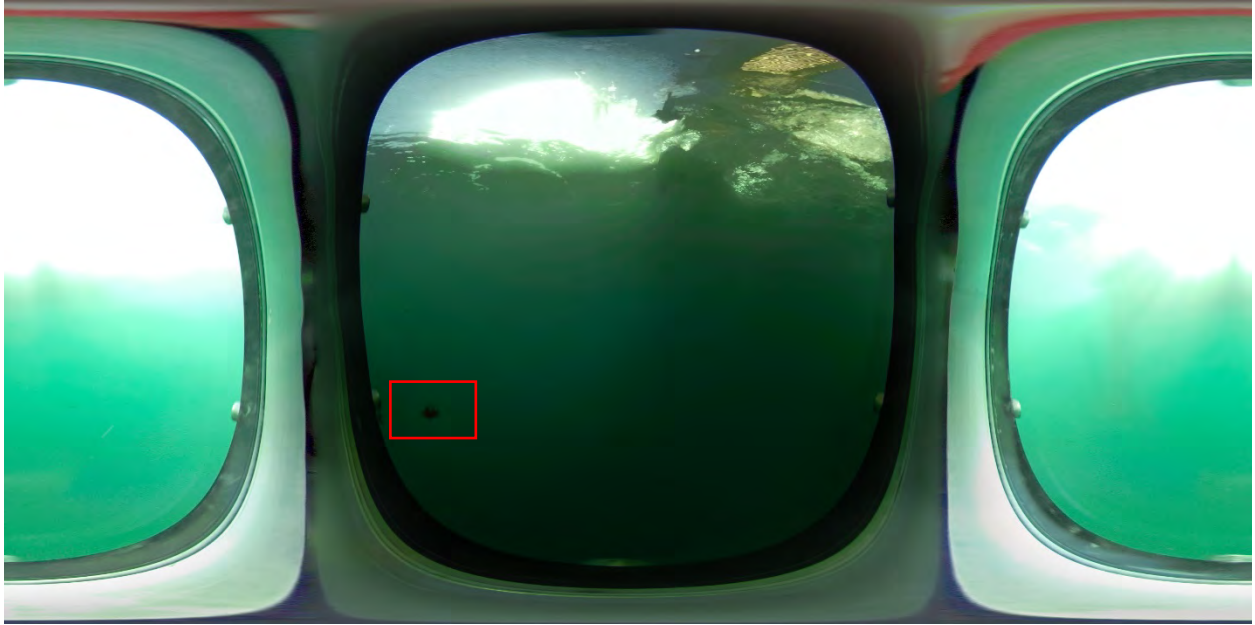

*Appendix B Deployment 1 Still 005.*

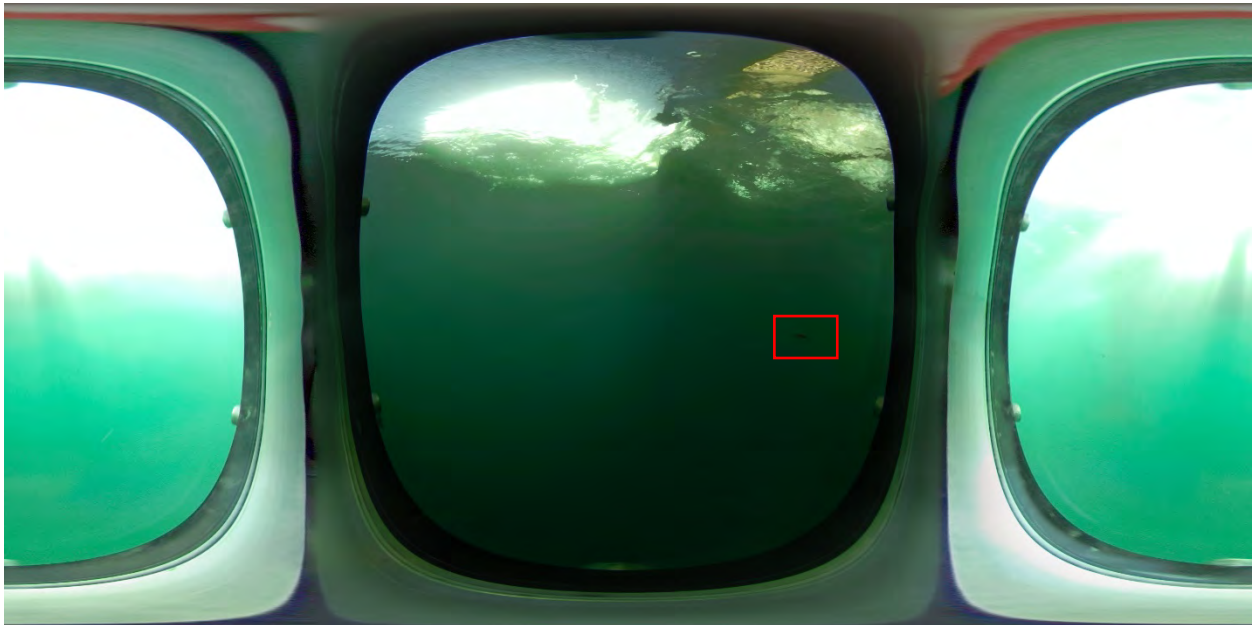

*Appendix B Deployment 1 Still 006.*





*Appendix B Deployment 1 Still 007.*

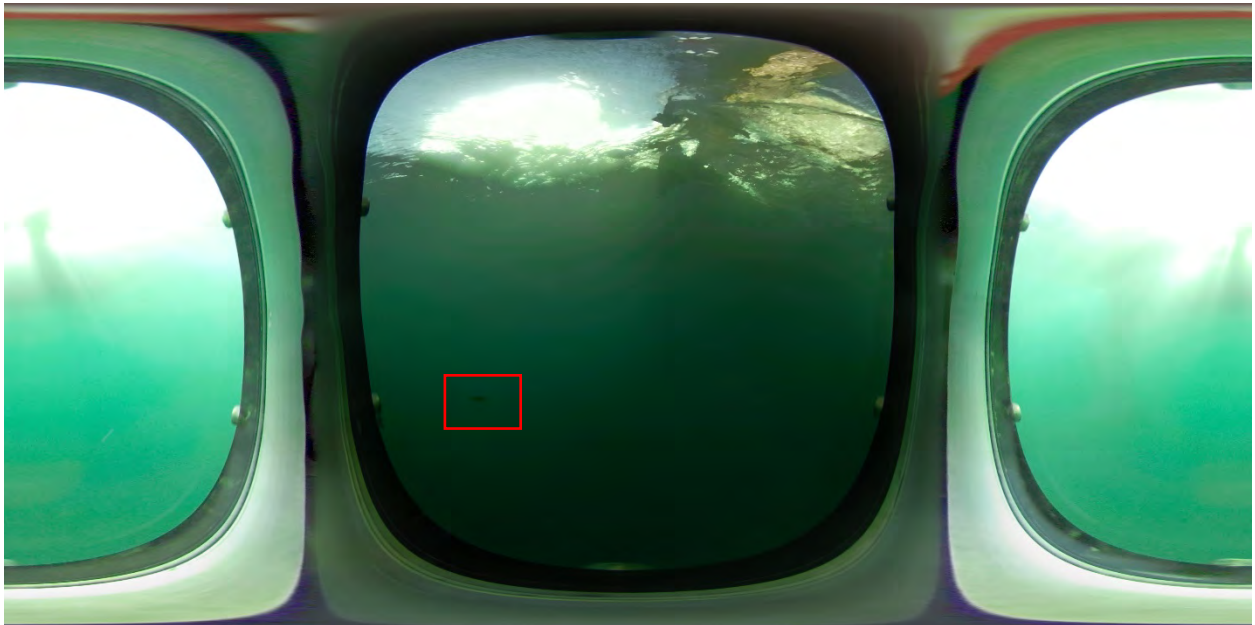

*Appendix B Deployment 1 Still 008.*



*Appendix B Deployment 1 Still 009.*



*Appendix B Deployment 2 Still 001.*

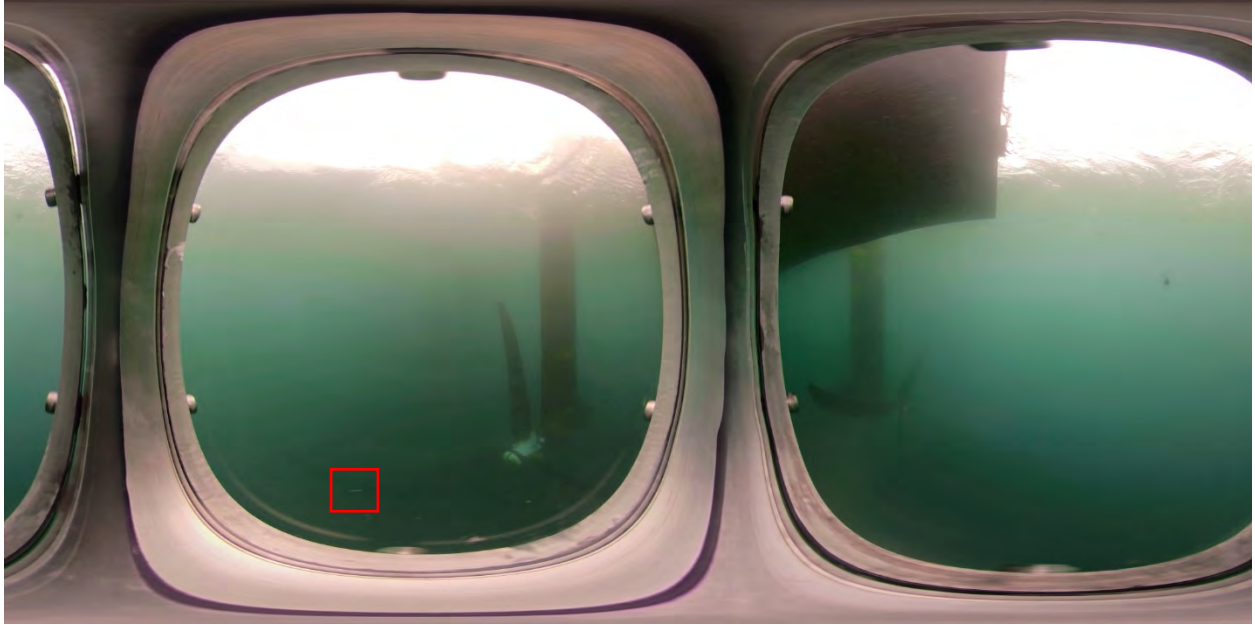

Appendix B Deployment 2 Still 002.



Appendix B Deployment 2 Still 003.



*Appendix B Deployment 2 Still 004.*

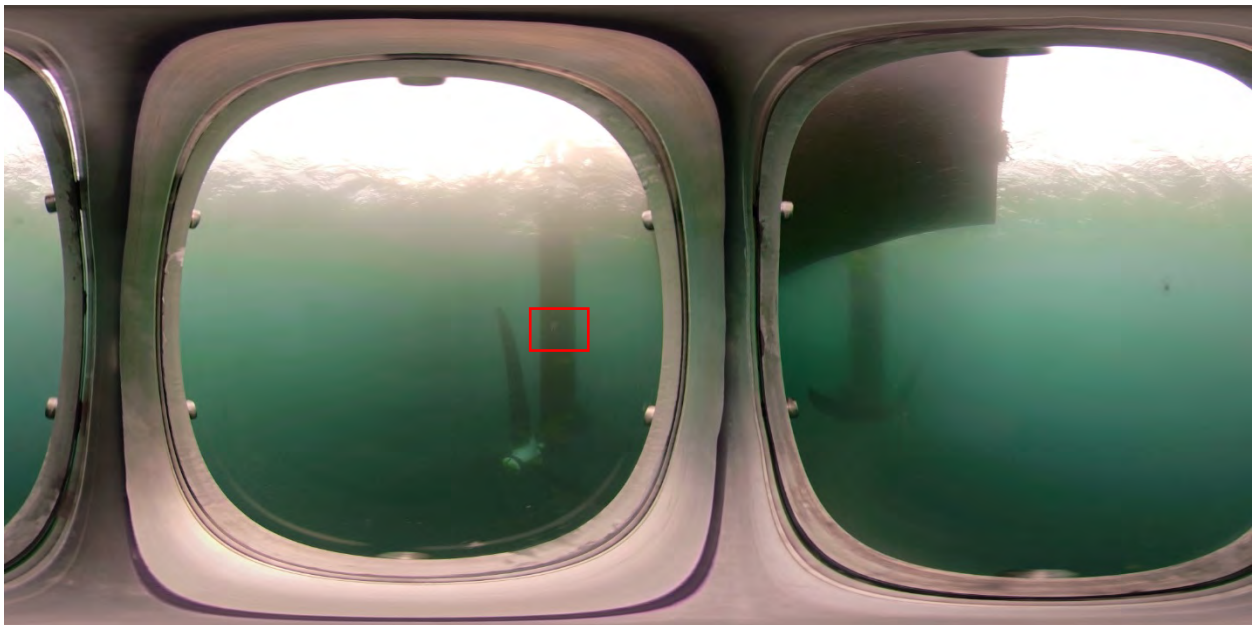

*Appendix B Deployment 2 Still 005.*

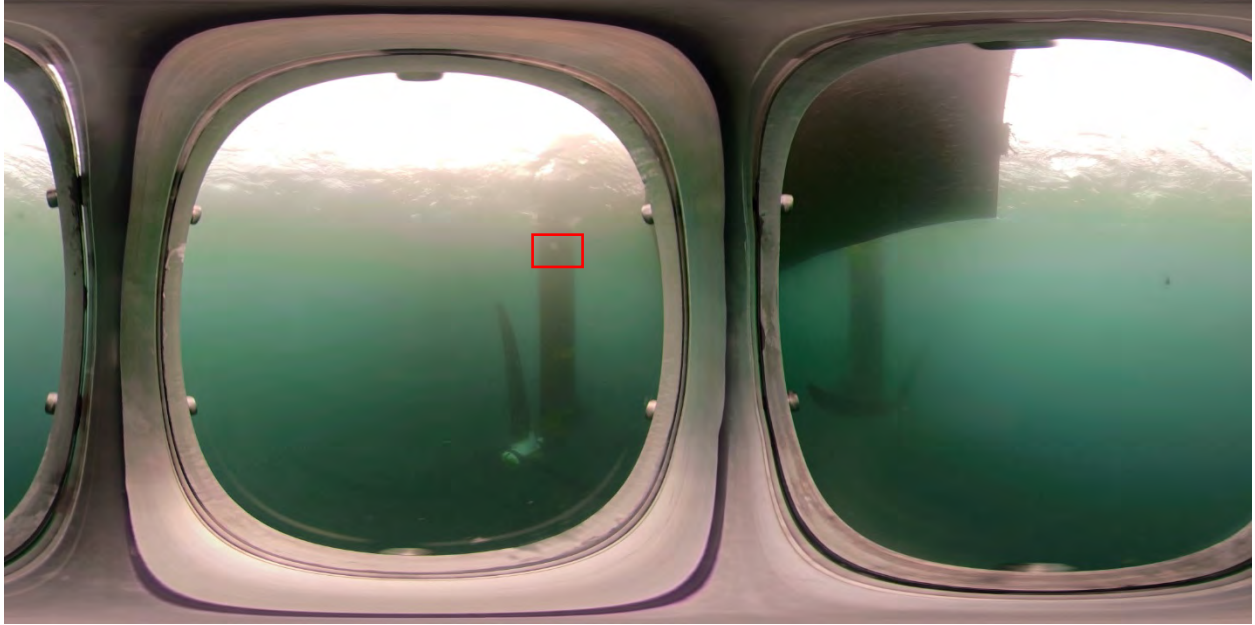

*Appendix B Deployment 2 Still 006.*



*Appendix B Deployment 2 Still 007.*



*Appendix B Deployment 2 Still 008.*



*Appendix B Deployment 2 Still 009.*



*Appendix B Deployment 2 Still 010.*



*Appendix B Deployment 2 Still 011.*



Appendix B Deployment 2 Still 012.



Appendix B Deployment 2 Still 013.





*Appendix B Deployment 2 Still 014.*



*Appendix B Deployment 2 Still 015.*



*Appendix B Deployment 2 Still 016.*



*Appendix B Deployment 2 Still 017.*



*Appendix B Deployment 2 Still 018.*

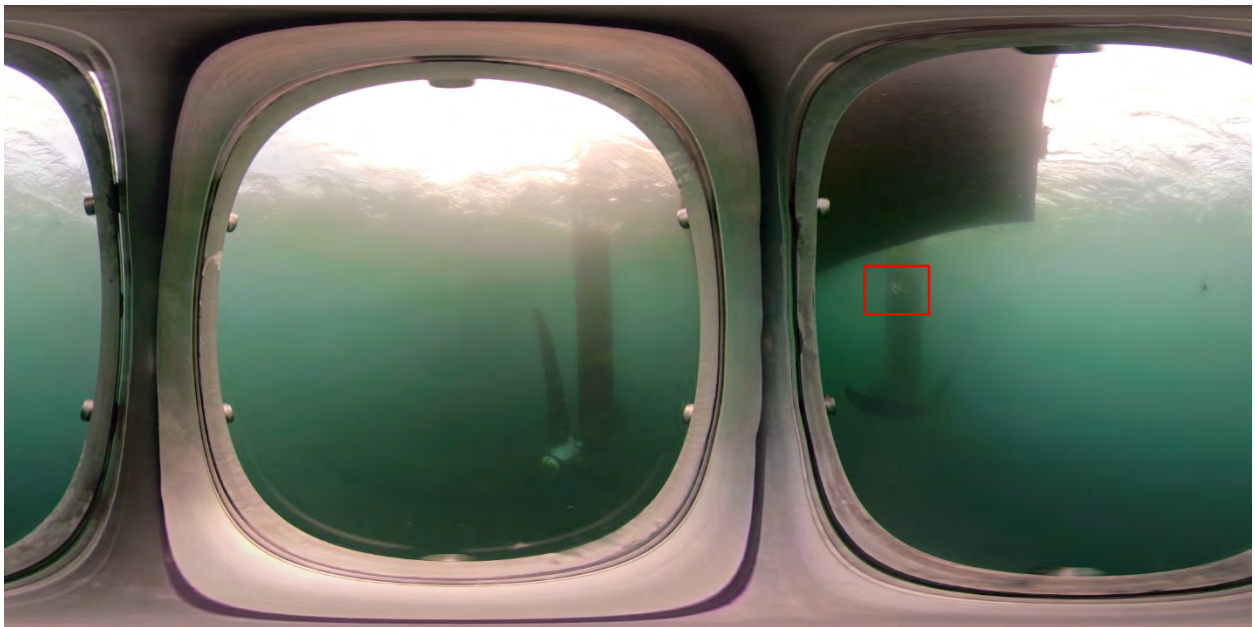

*Appendix B Deployment 2 Still 019.*



*Appendix B Deployment 2 Still 020.*



*Appendix B Deployment 2 Still 021.*



*Appendix B Deployment 2 Still 022.*



*Appendix B Deployment 2 Still 023.*



*Appendix B Deployment 2 Still 024.*



*Appendix B Deployment 2 Still 025.*



Appendix B Deployment 2 Still 026.



Appendix B Deployment 2 Still 027.



*Appendix B Deployment 2 Still 028.*



*Appendix B Deployment 2 Still 029.*





*Appendix B Deployment 2 Still 030.*



*Appendix B Deployment 2 Still 031.*



*Appendix B Deployment 2 Still 032.*



*Appendix B Deployment 2 Still 033.*



*Appendix B Deployment 2 Still 034.*

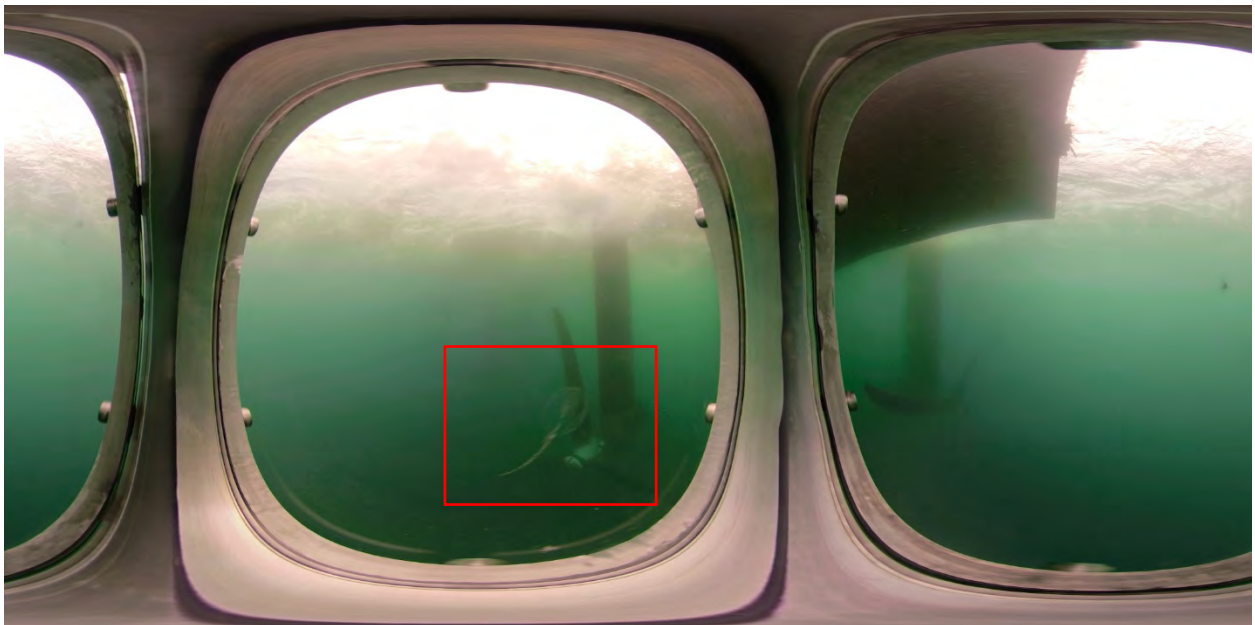

*Appendix B Deployment 2 Still 035.*



*Appendix B Deployment 2 Still 036.*



*Appendix B Deployment 2 Still 037.*

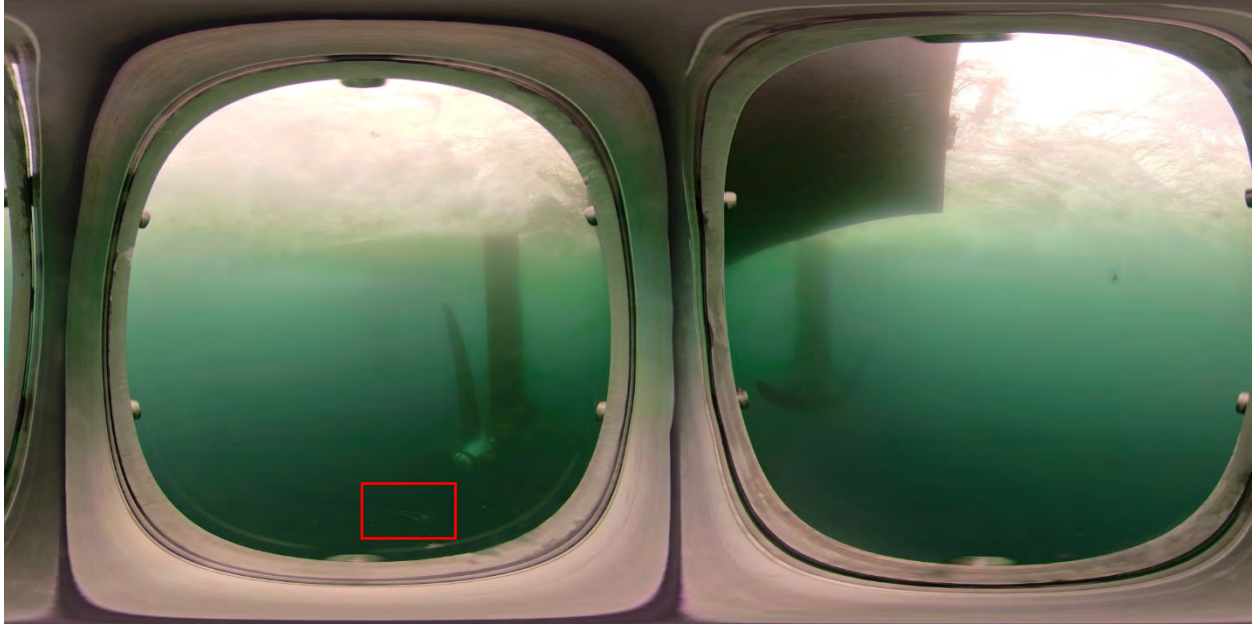

*Appendix B Deployment 2 Still 038.*



*Appendix B Deployment 2 Still 039.*



*Appendix B Deployment 2 Still 040.*



*Appendix B Deployment 2 Still 041.*



*Appendix B Deployment 2 Still 042.*



*Appendix B Deployment 2 Still 043.*

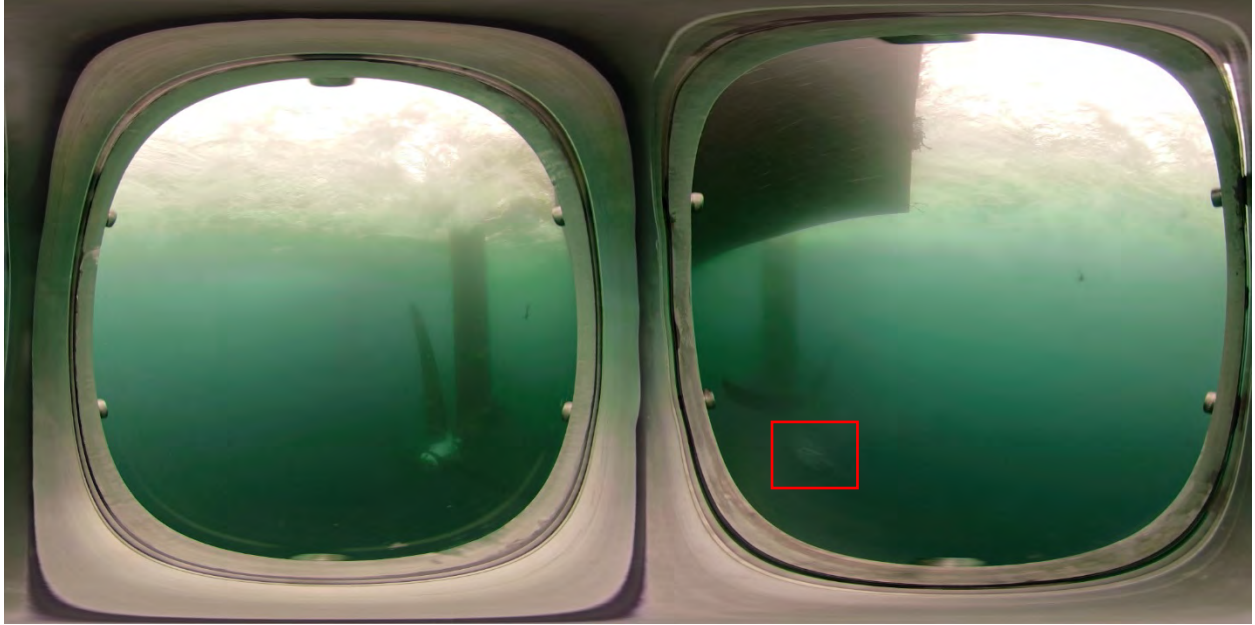

*Appendix B Deployment 2 Still 044.*

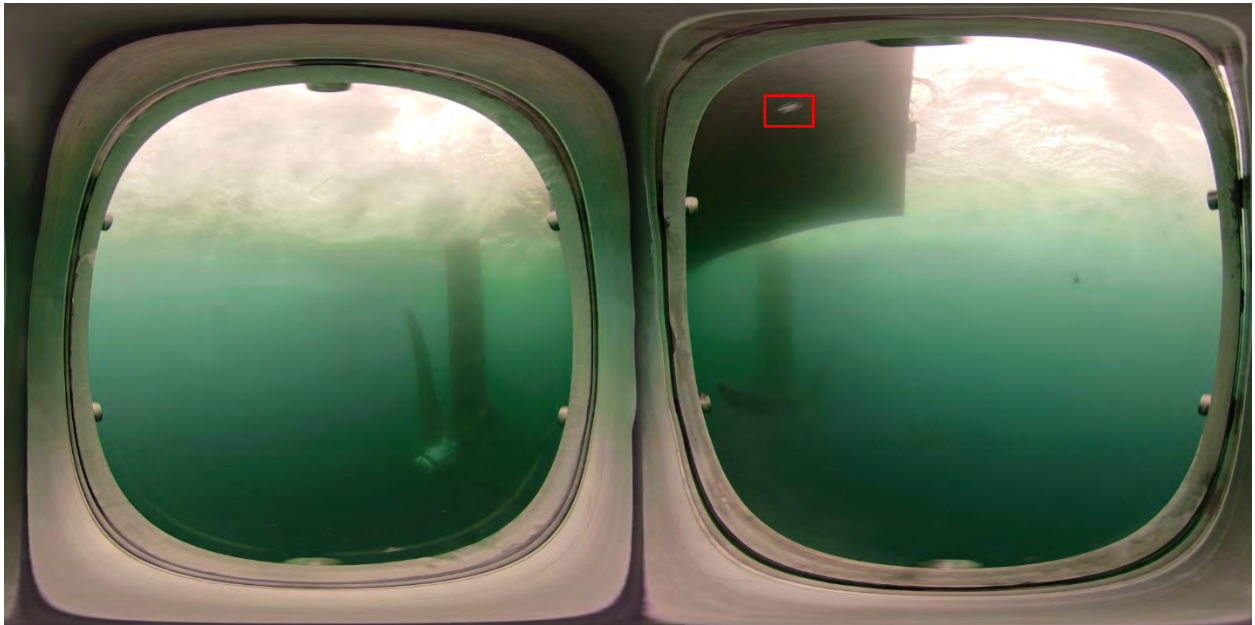

*Appendix B Deployment 2 Still 45.*





*Appendix B Deployment 2 Still 046.*

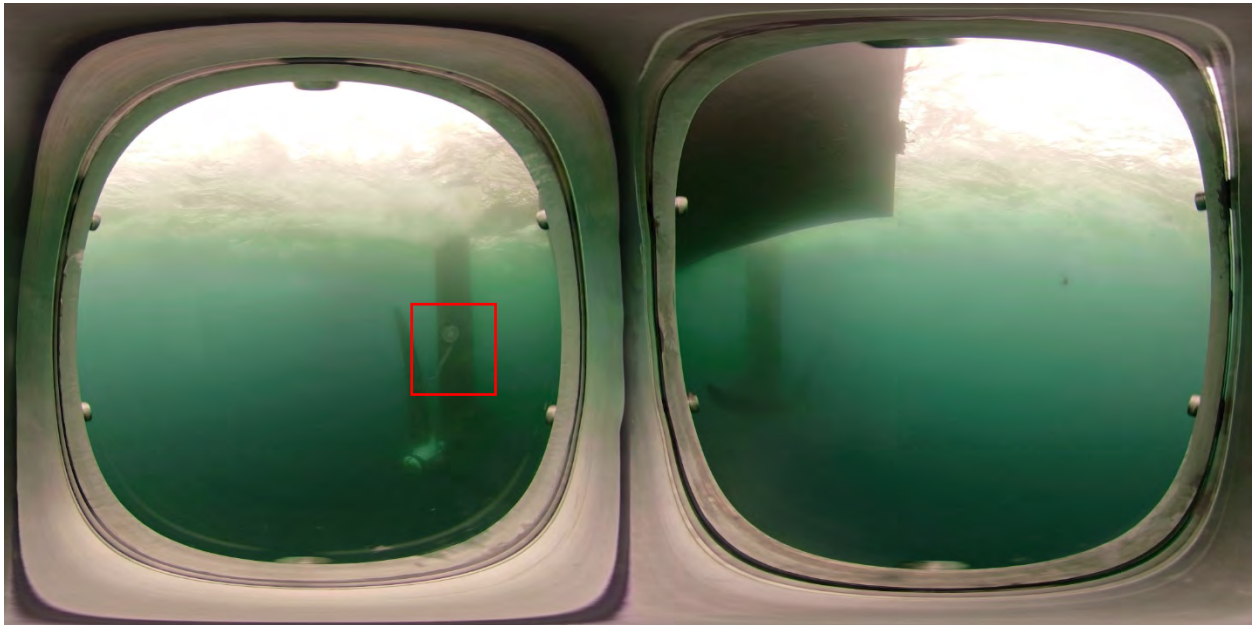

*Appendix B Deployment 2 Still 047.*



*Appendix B Deployment 2 Still 048.*



*Appendix B Deployment 2 Still 049.*

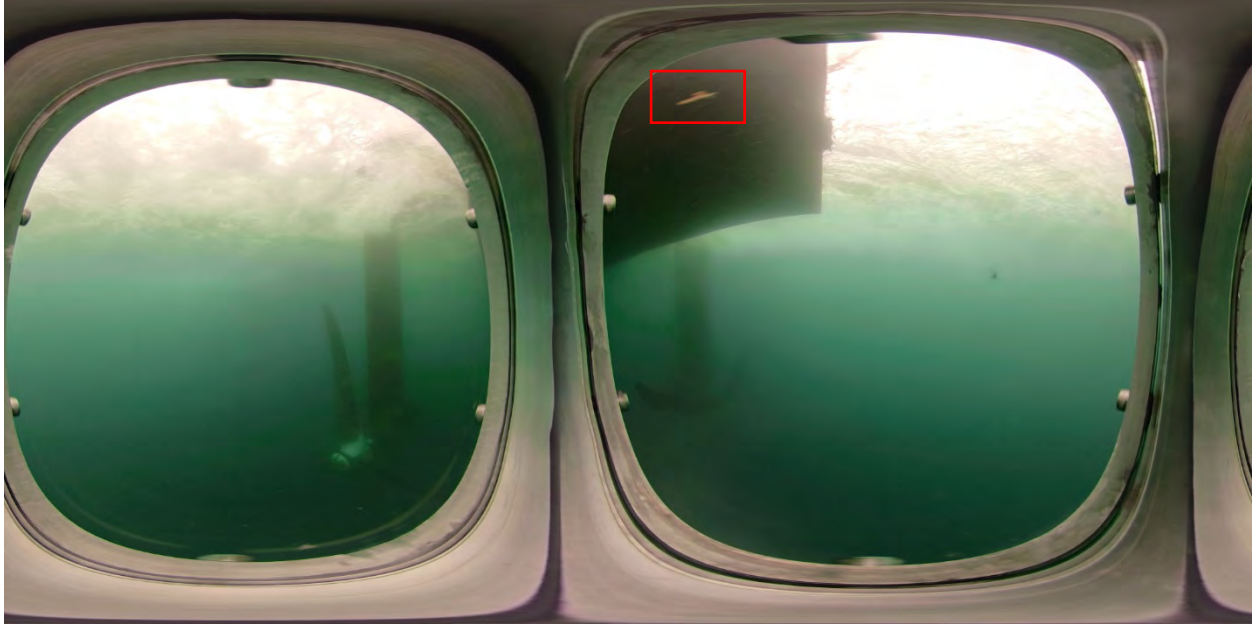

*Appendix B Deployment 2 Still 050.*

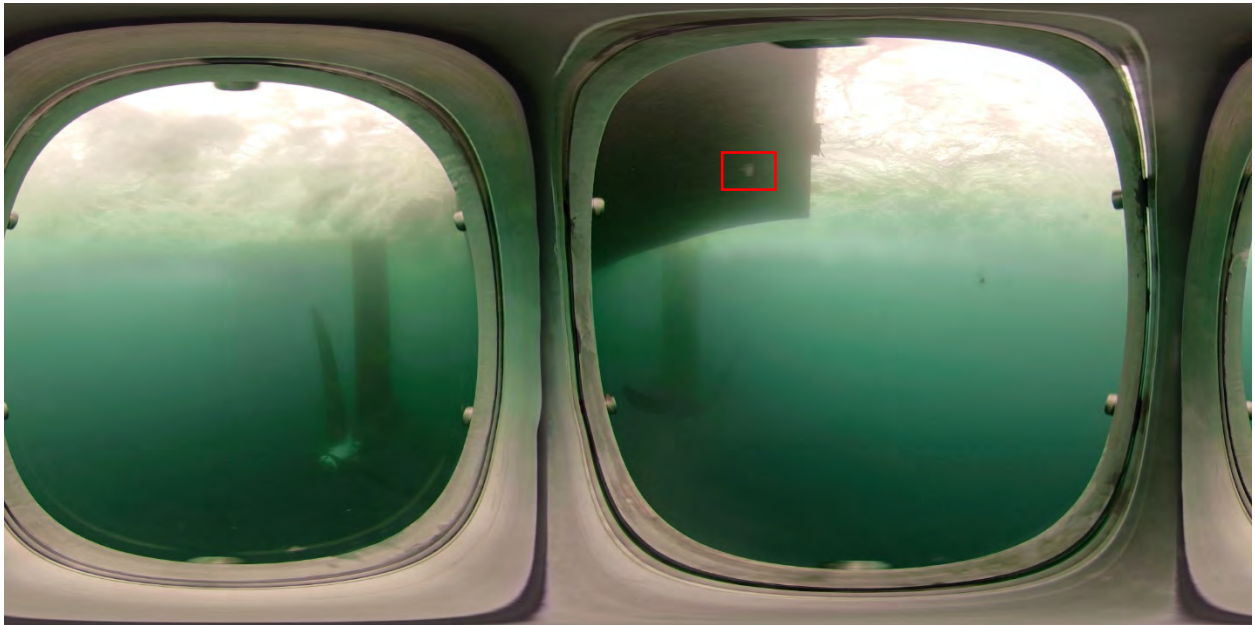

*Appendix B Deployment 2 Still 051.*



*Appendix B Deployment 2 Still 052.*

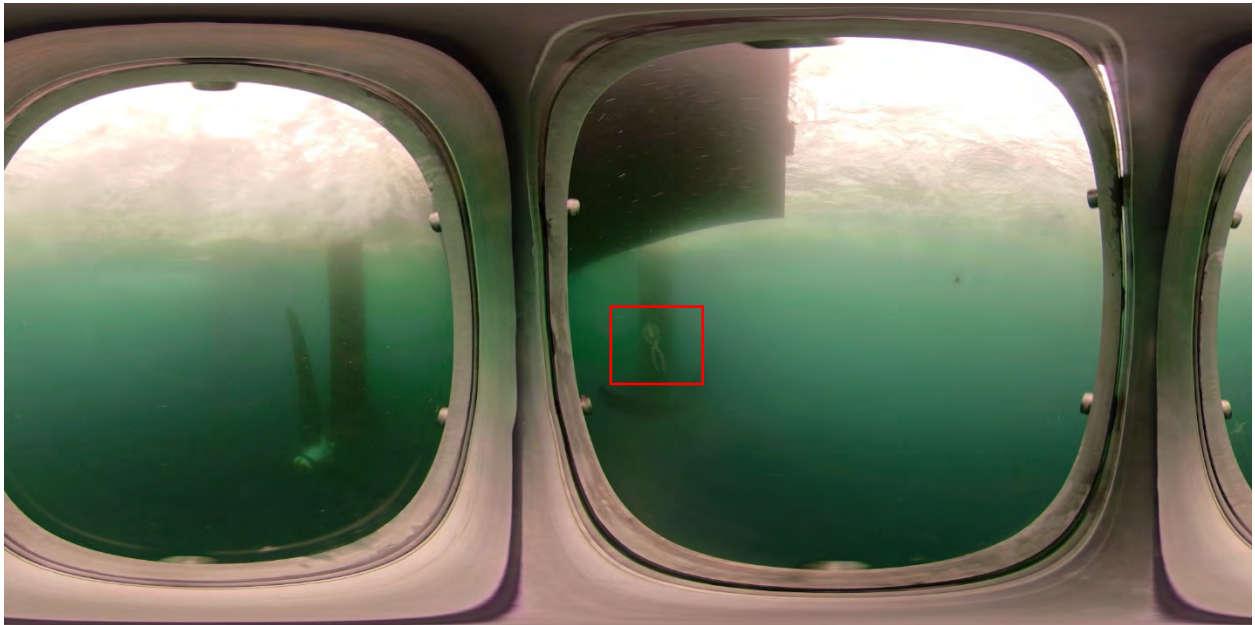

*Appendix B Deployment 2 Still 053.*

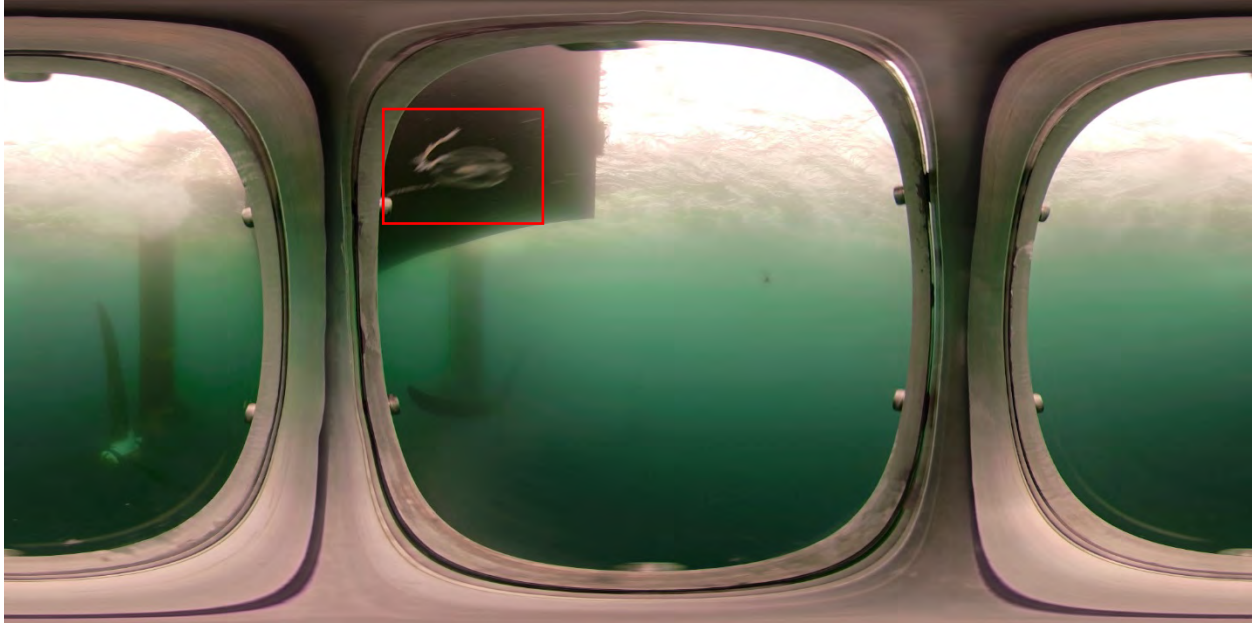

*Appendix B Deployment 2 Still 054.*



*Appendix B Deployment 2 Still 055.*

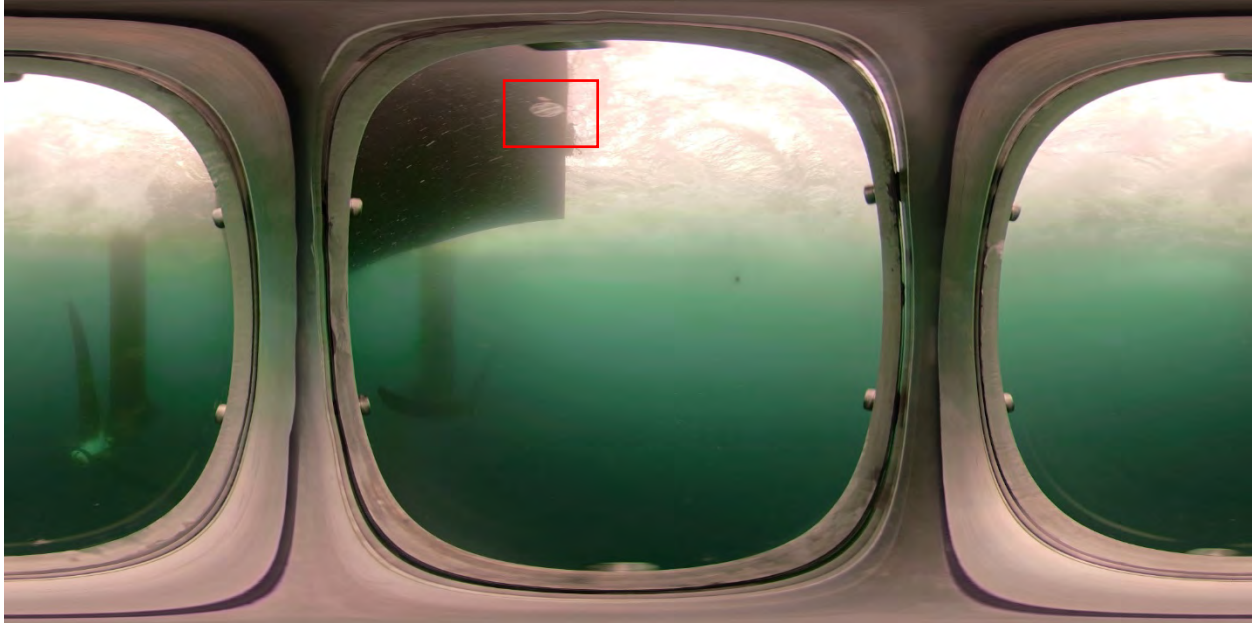

*Appendix B Deployment 2 Still 056.*

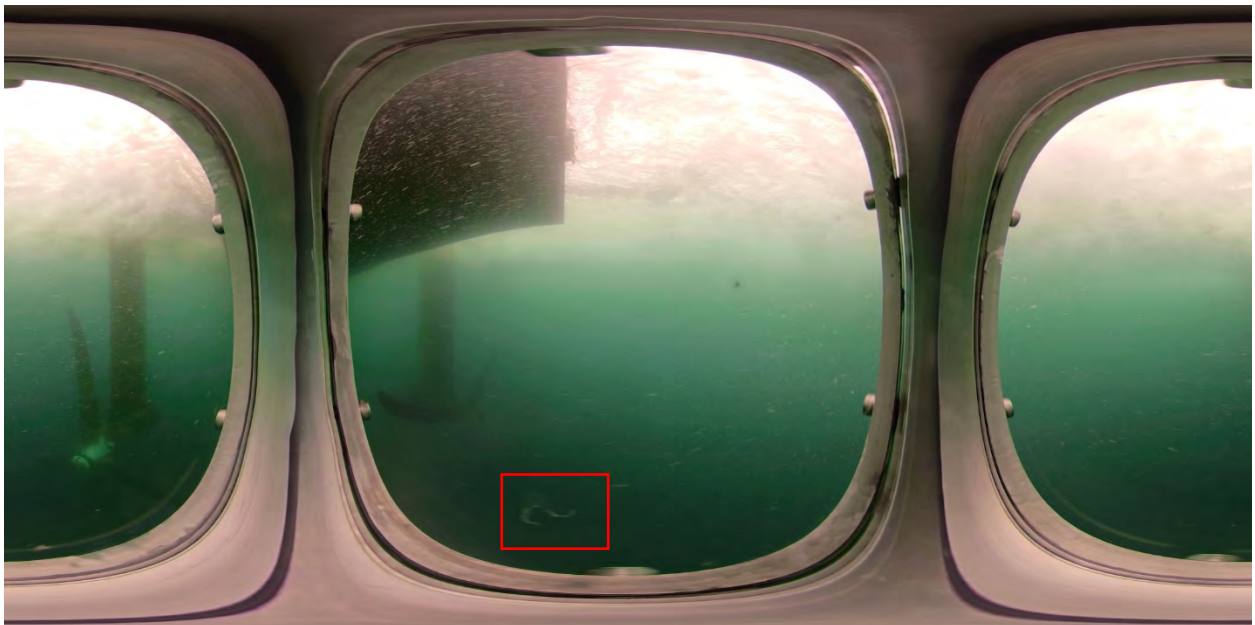

*Appendix B Deployment 2 Still 057.*

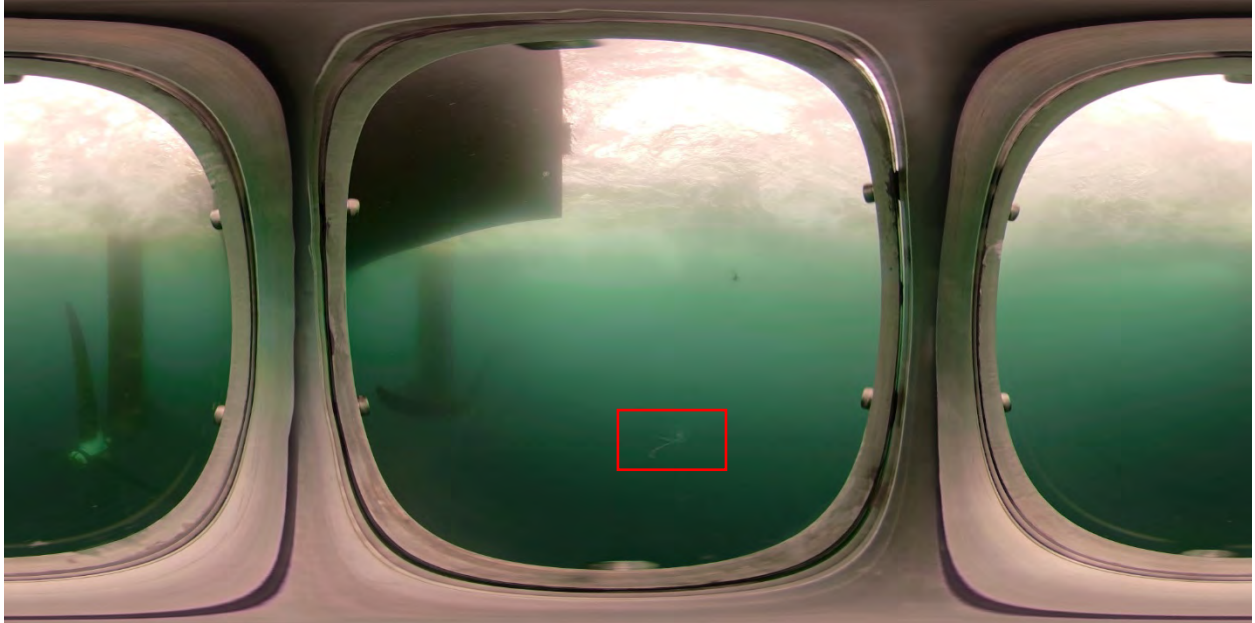

*Appendix B Deployment 2 Still 058.*

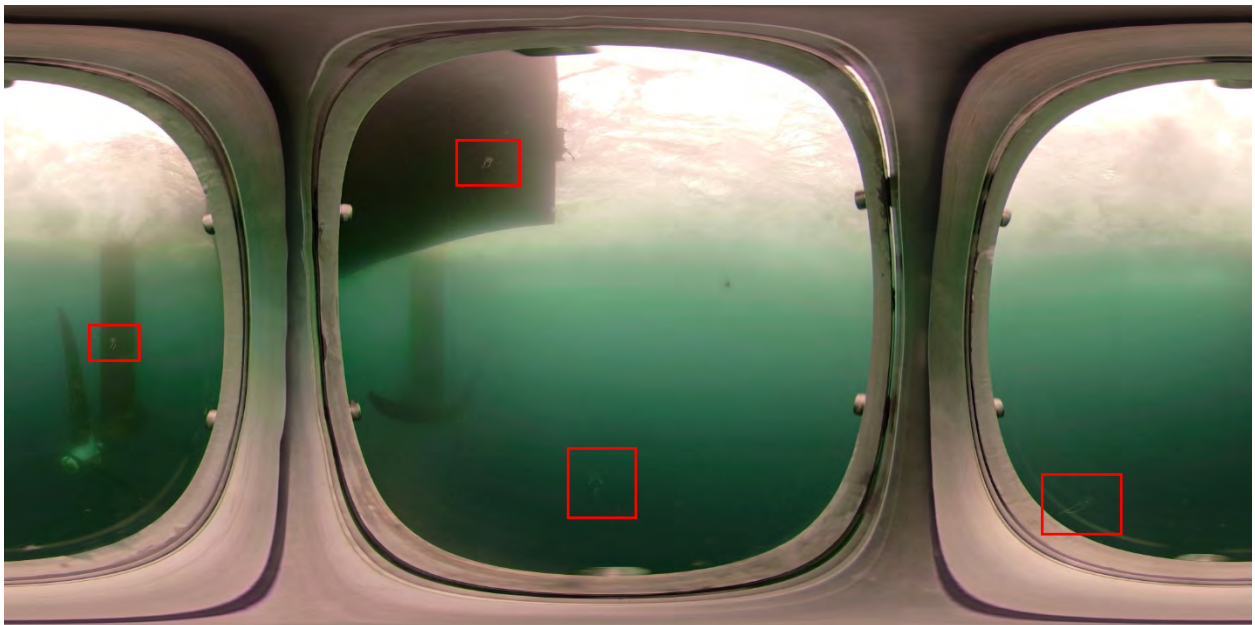

*Appendix B Deployment 2 Still 059.*



*Appendix B Deployment 2 Still 060.*



*Appendix B Deployment 2 Still 061.*





*Appendix B Deployment 2 Still 062.*

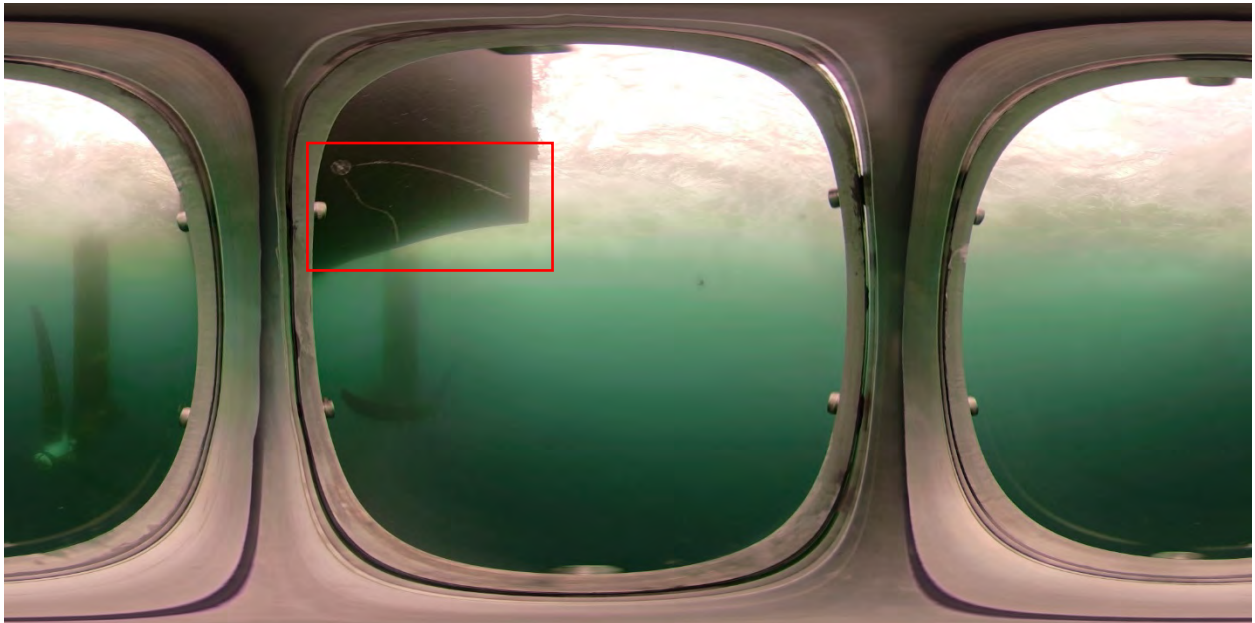

*Appendix B Deployment 2 Still 063.*

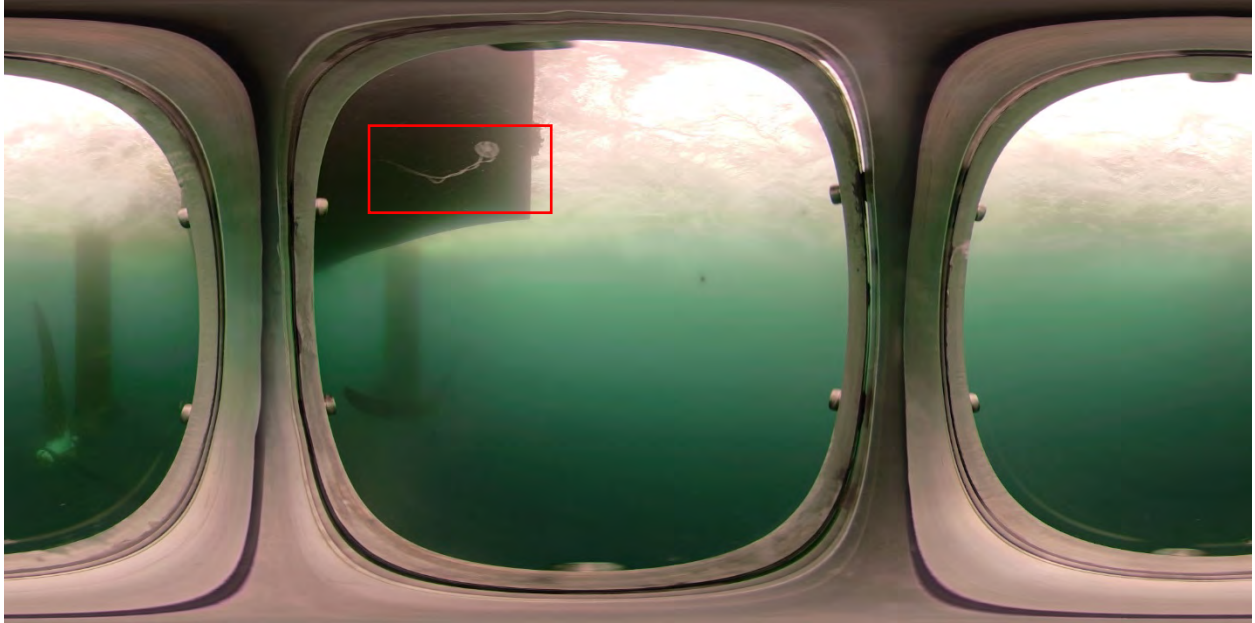

*Appendix B Deployment 2 Still 064.*

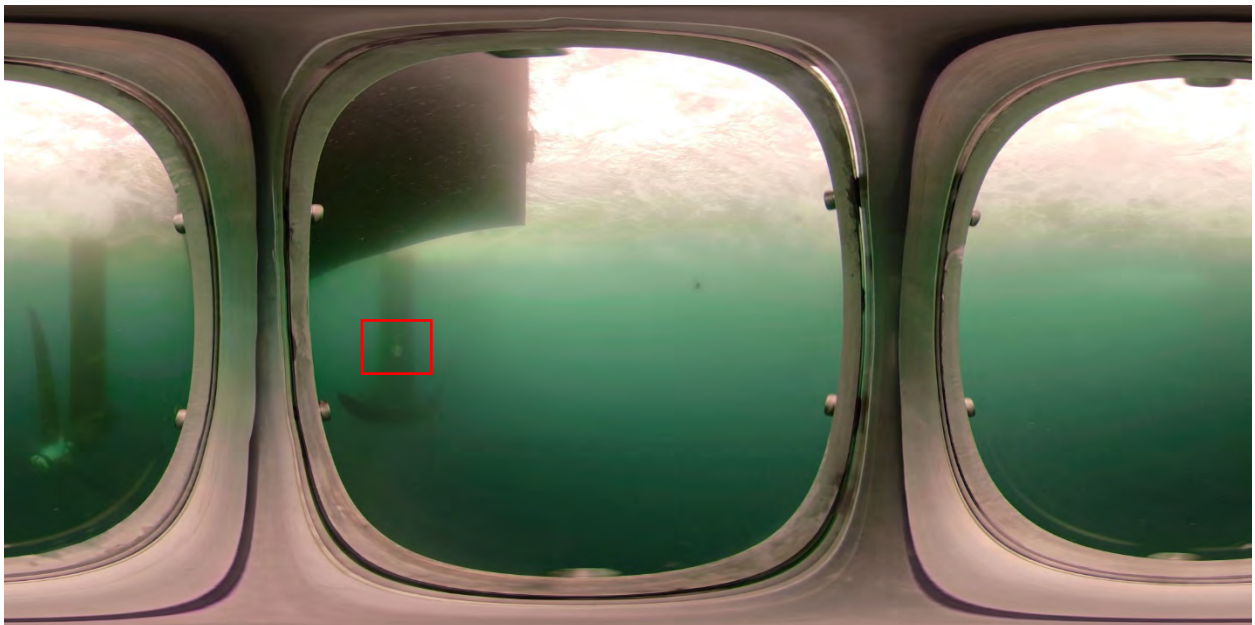

*Appendix B Deployment 2 Still 065.*

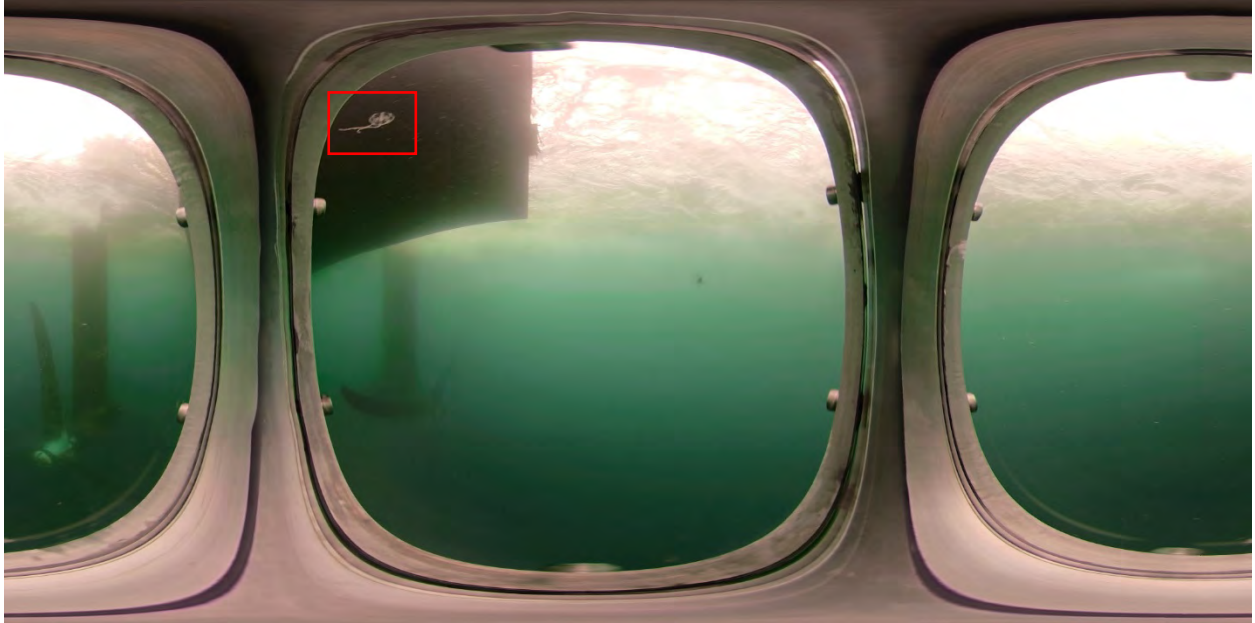

*Appendix B Deployment 2 Still 066.*

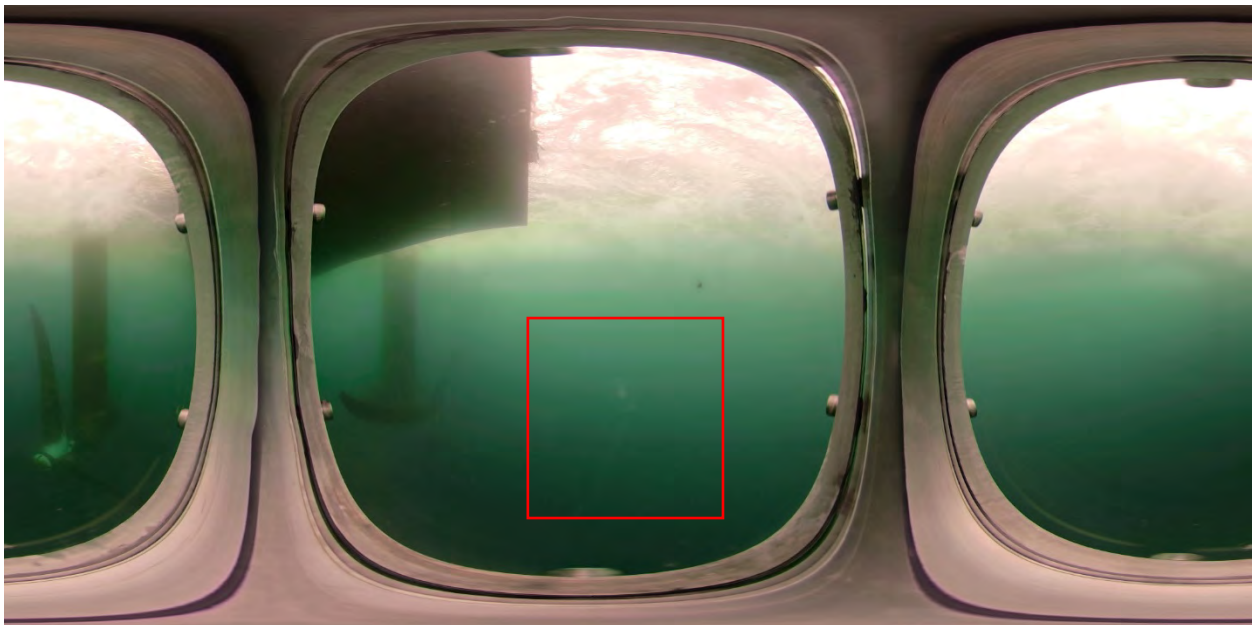

*Appendix B Deployment 2 Still 067.*

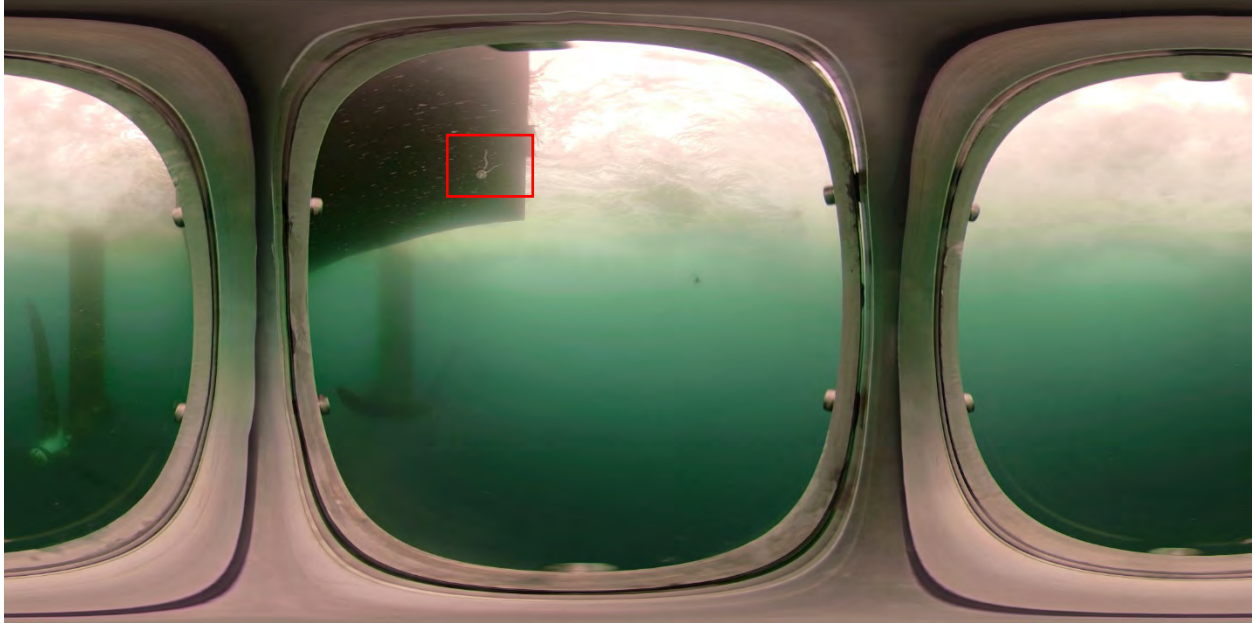

*Appendix B Deployment 2 Still 068.*

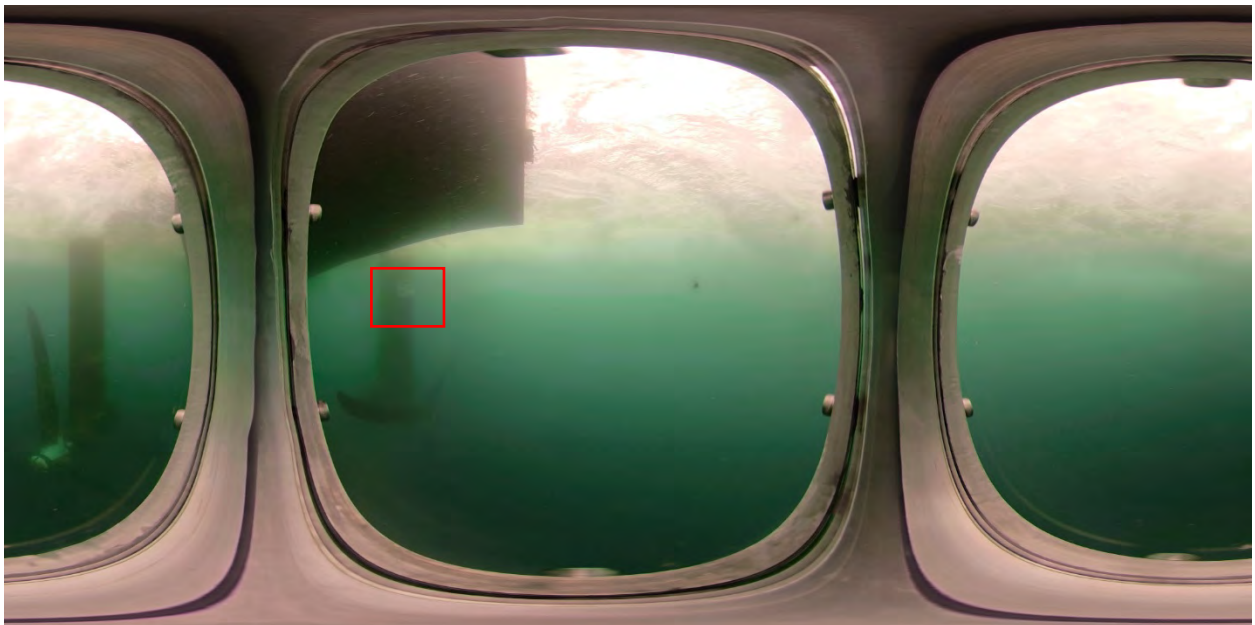

*Appendix B Deployment 2 Still 069.*



*Appendix B Deployment 2 Still 070.*

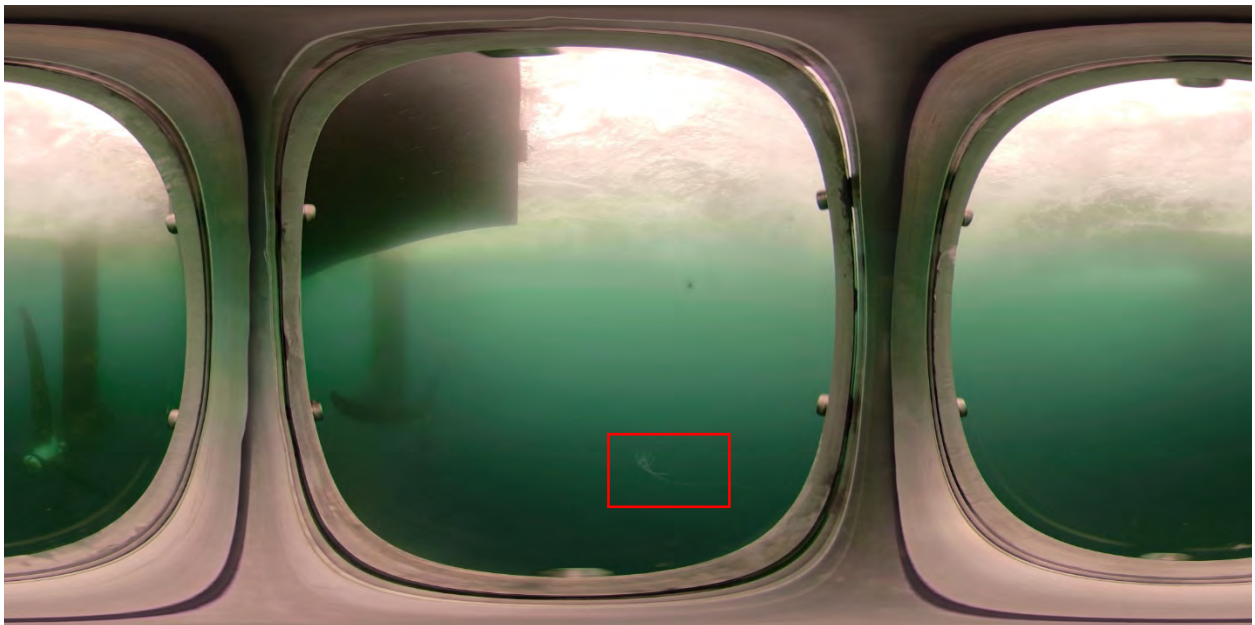

*Appendix B Deployment 2 Still 071.*

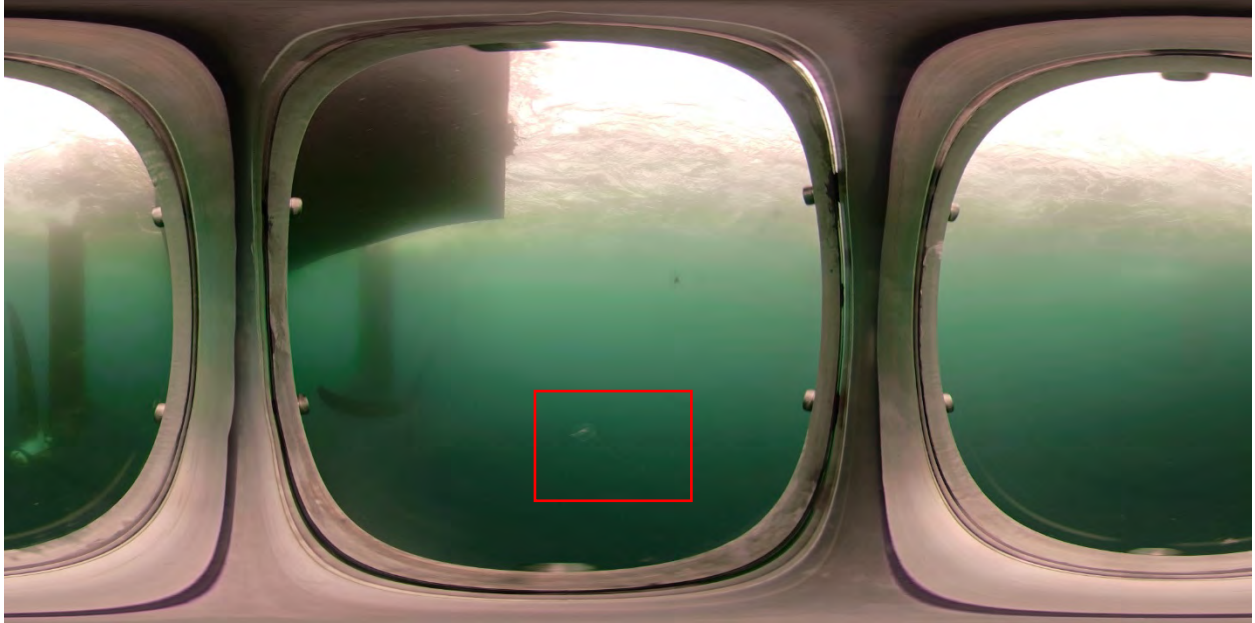

*Appendix B Deployment 2 Still 072.*

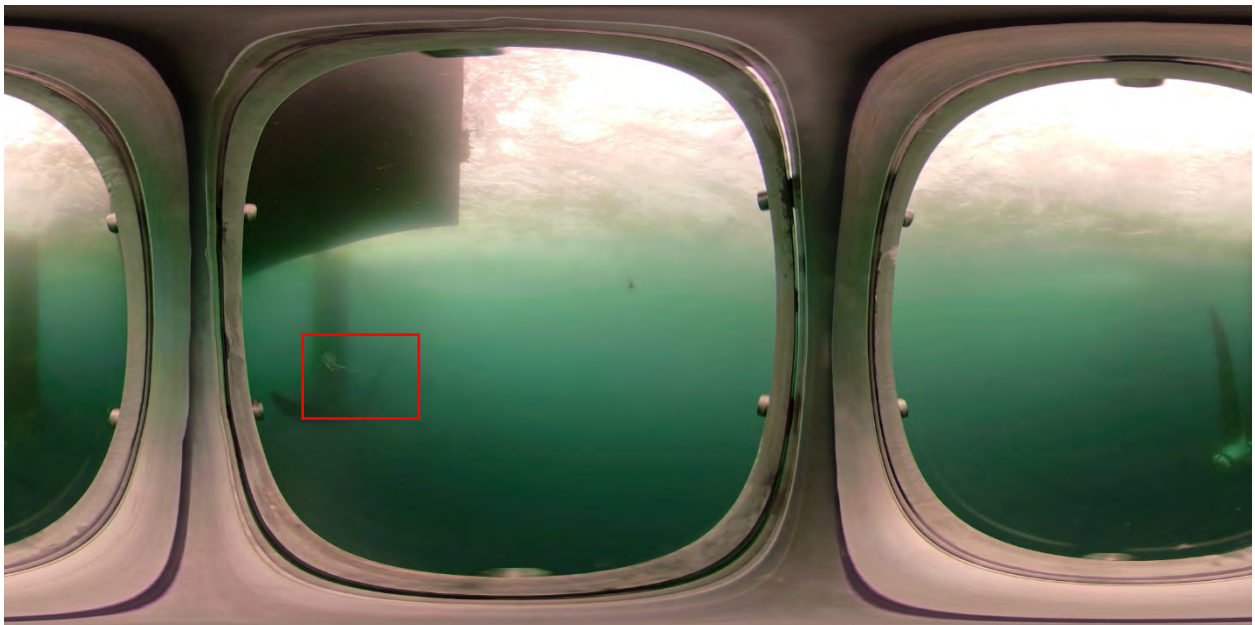

*Appendix B Deployment 2 Still 073.*



*Appendix B Deployment 2 Still 074.*

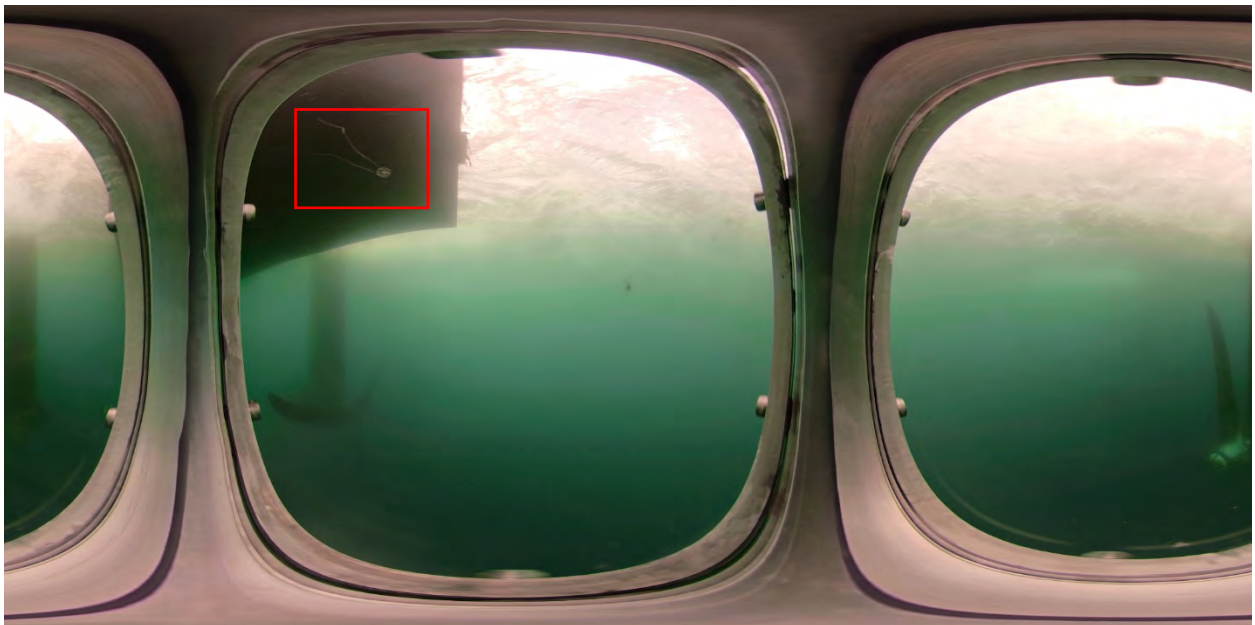

*Appendix B Deployment 2 Still 075.*

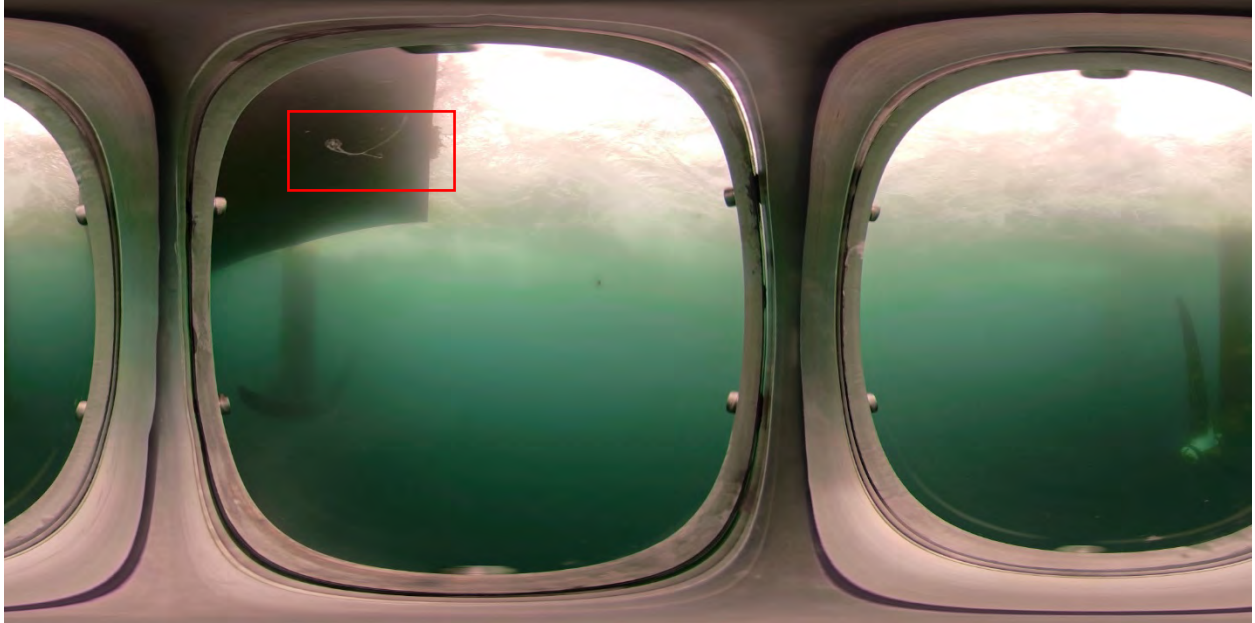

*Appendix B Deployment 2 Still 076.*

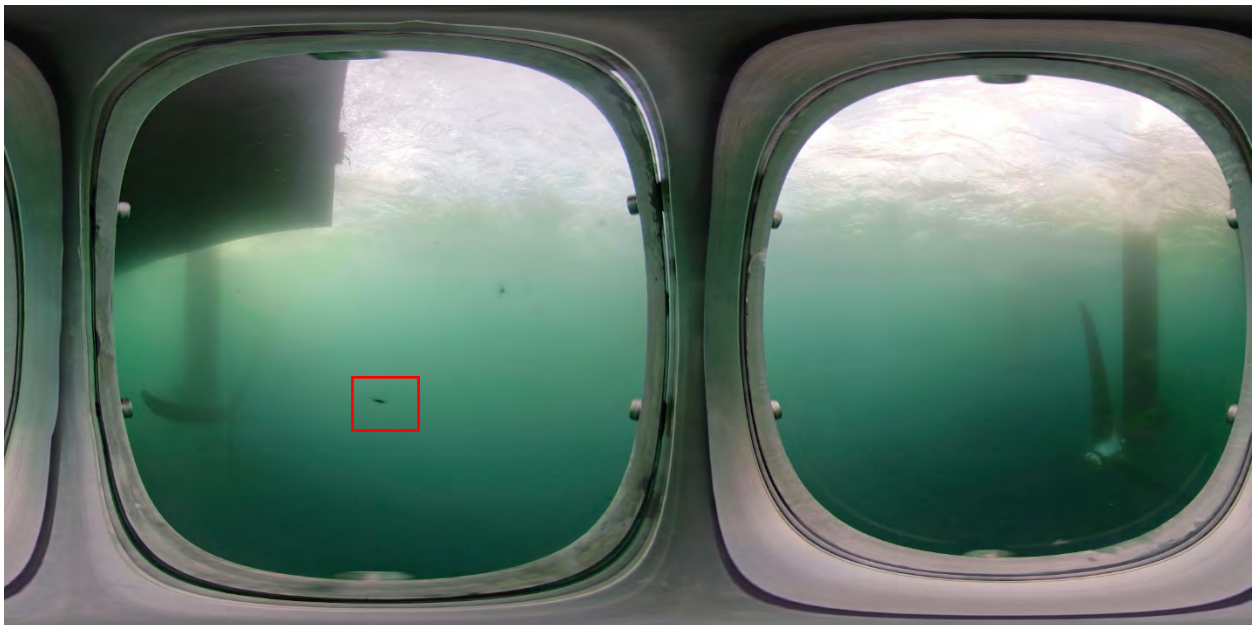

*Appendix B Deployment 2 Still 077.*



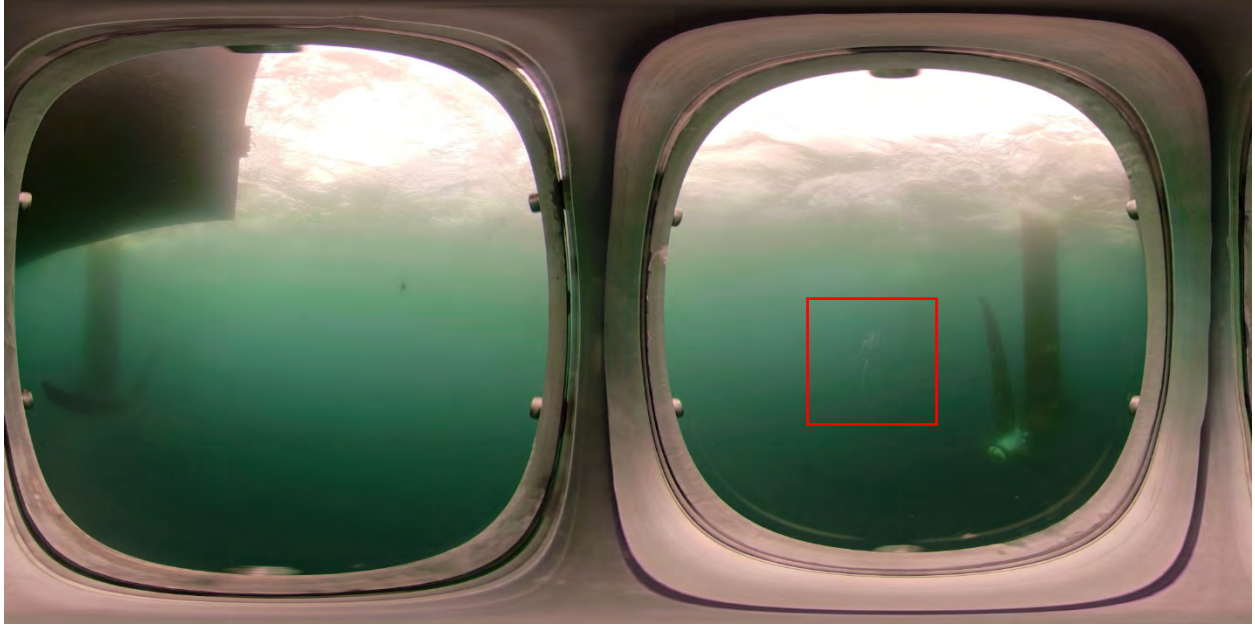

*Appendix B Deployment 2 Still 078.*

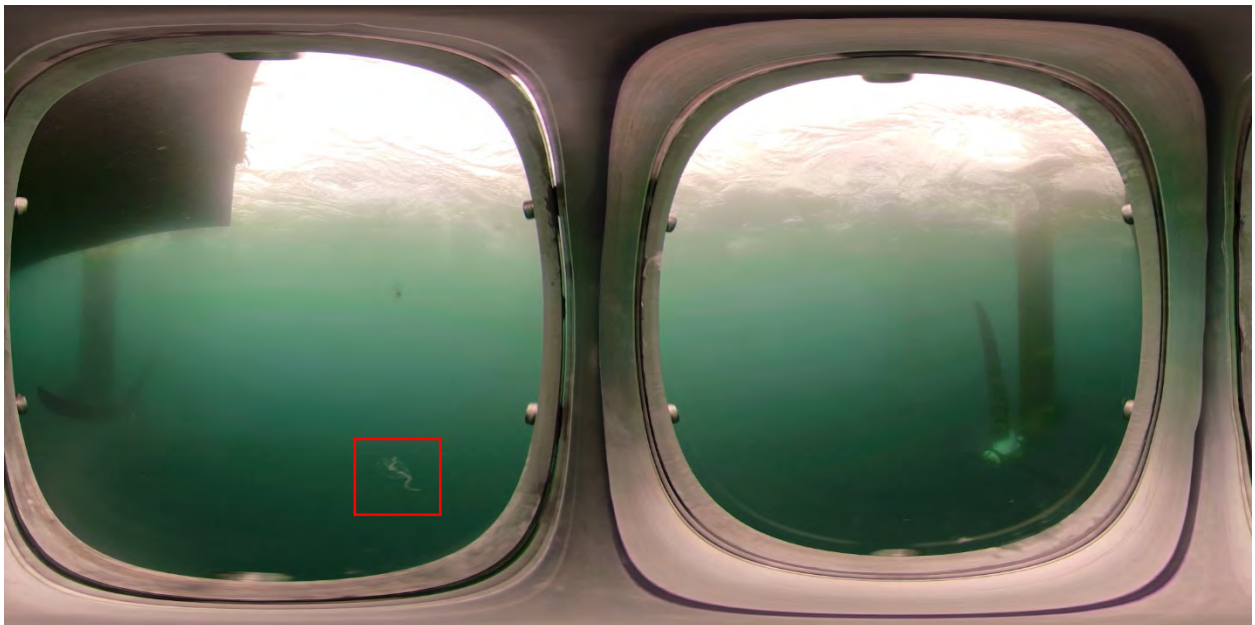

*Appendix B Deployment 2 Still 079.*

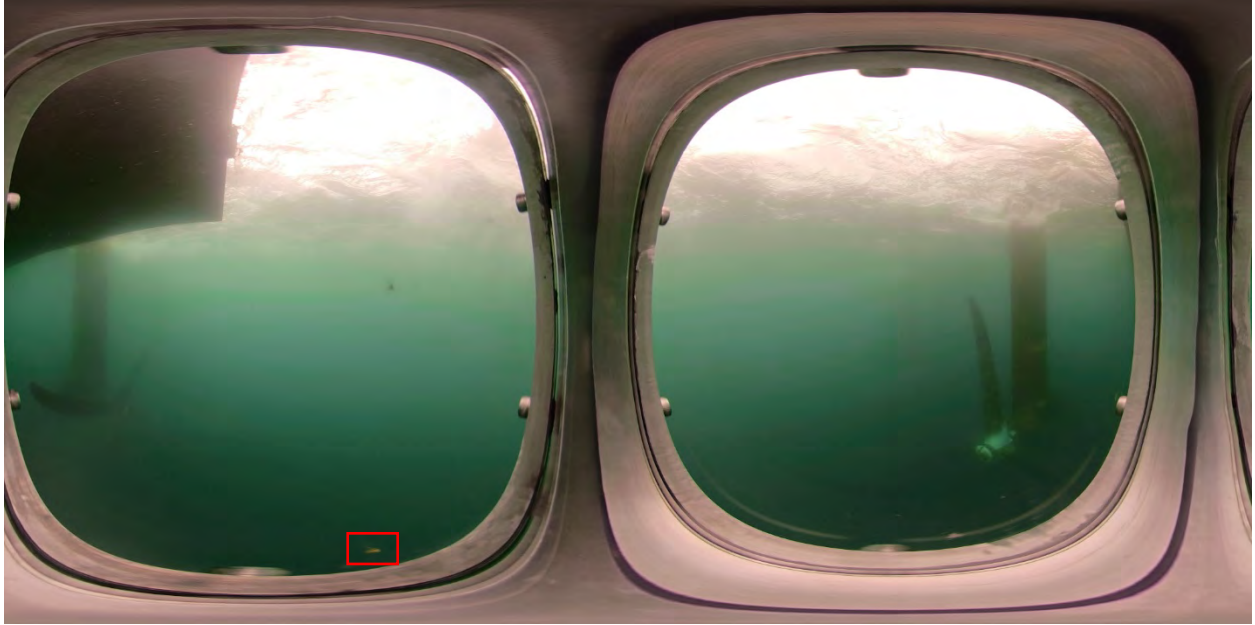

*Appendix B Deployment 2 Still 080.*



*Appendix B Deployment 2 Still 081.*

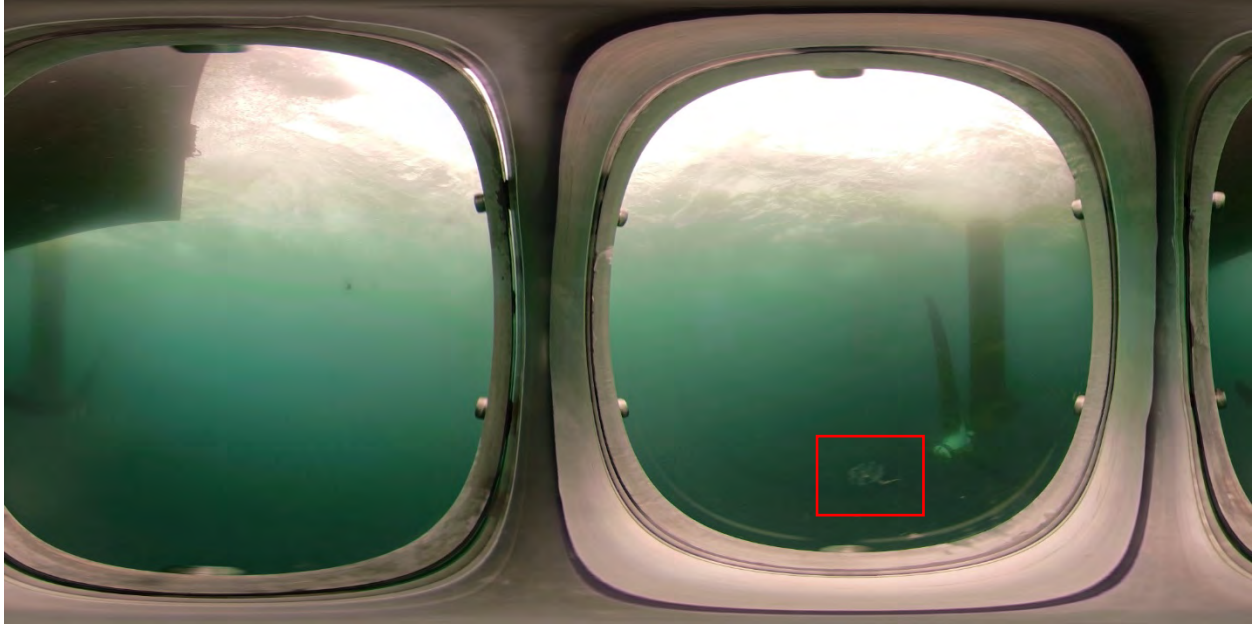

*Appendix B Deployment 2 Still 082.*

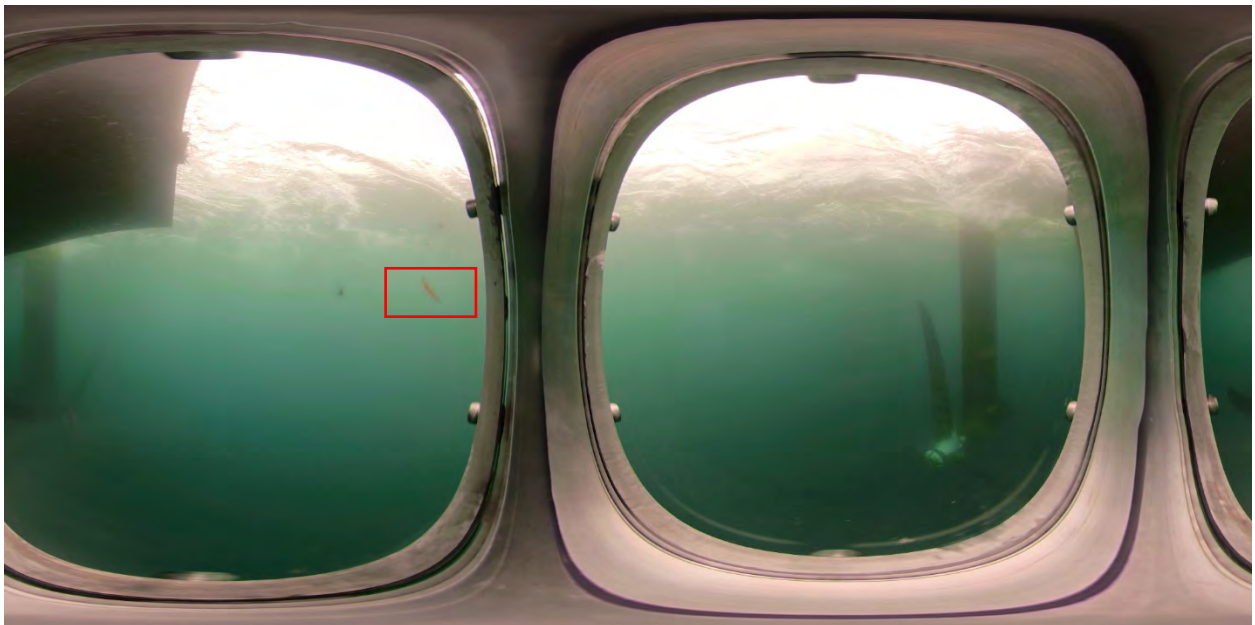

*Appendix B Deployment 2 Still 083.*

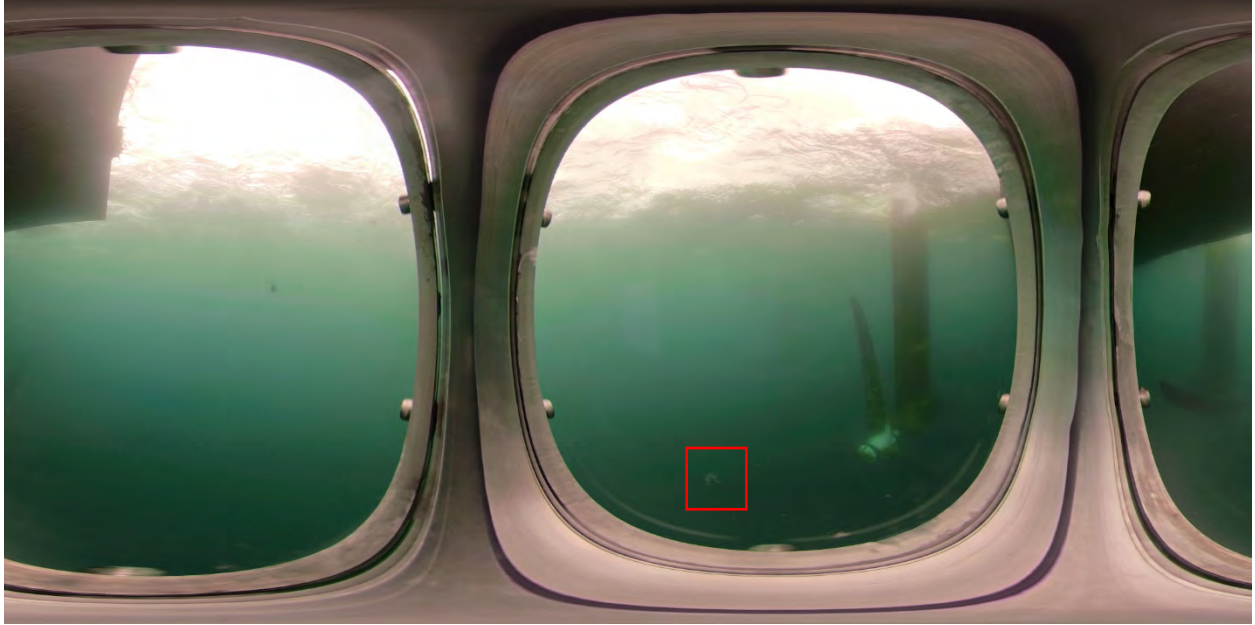

*Appendix B Deployment 2 Still 084.*

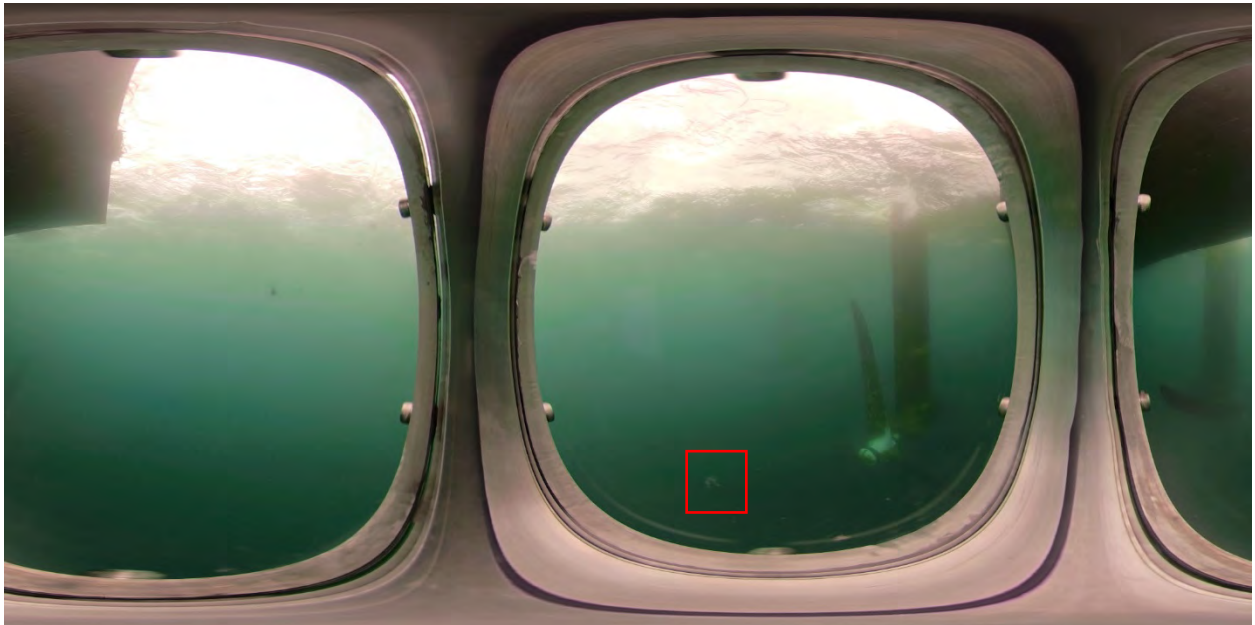

*Appendix B Deployment 2 Still 085.*

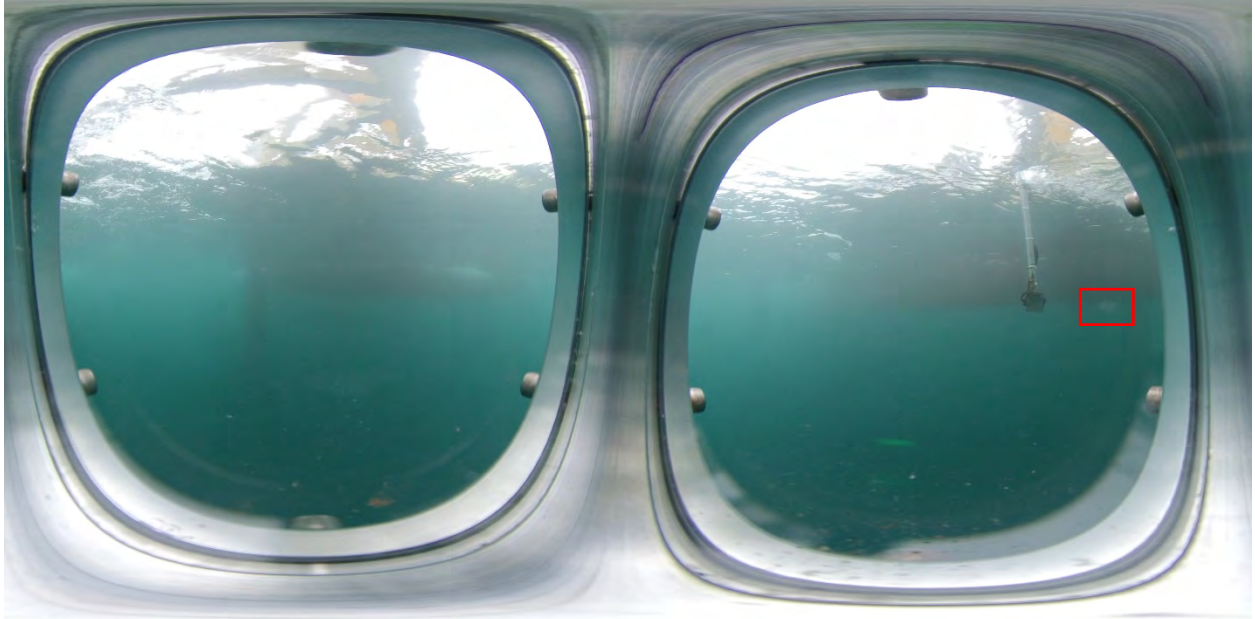

*Appendix B Deployment 4 Still 001.*

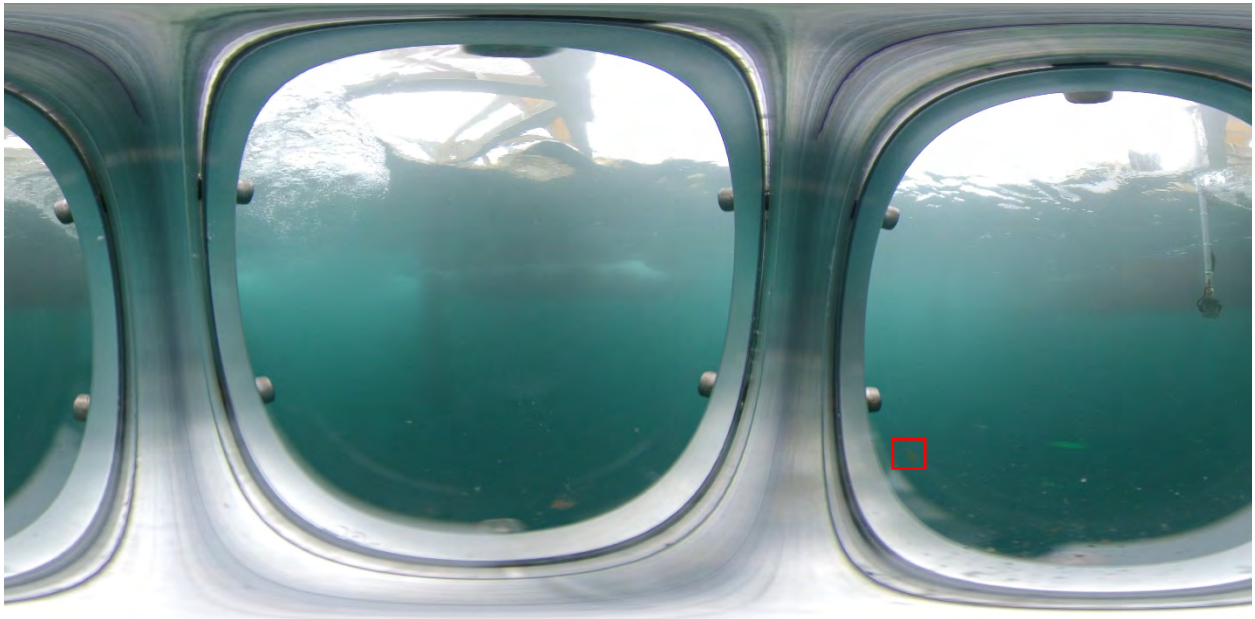

*Appendix B Deployment 4 Still 002.*

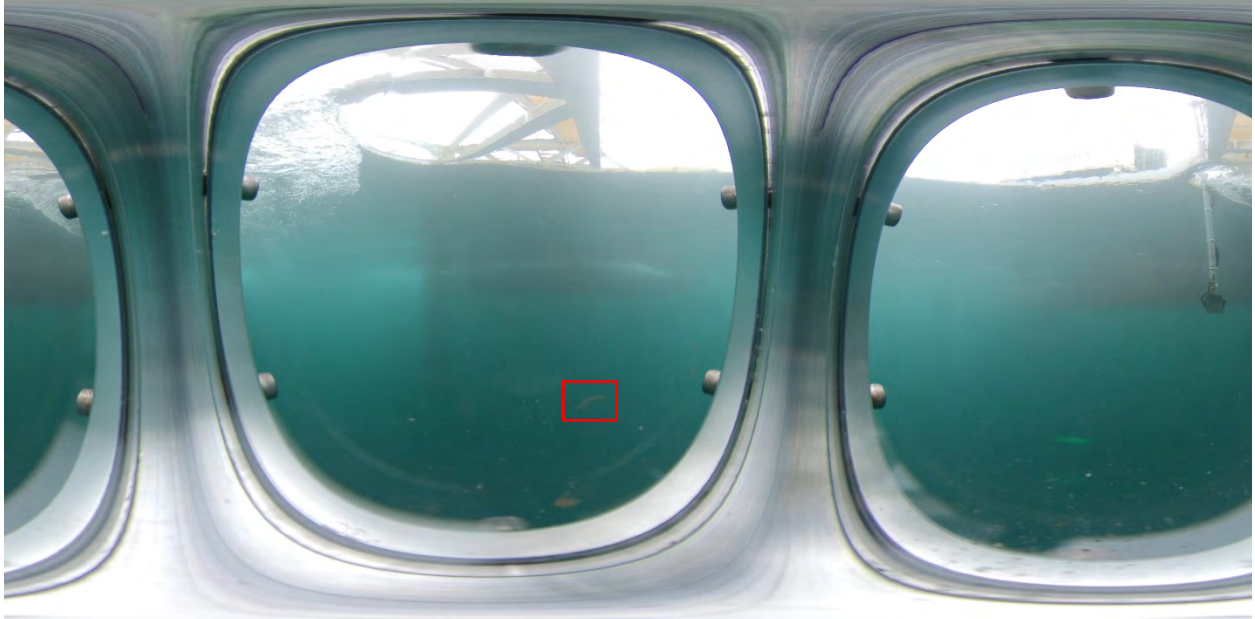

*Appendix B Deployment 4 Still 003.*

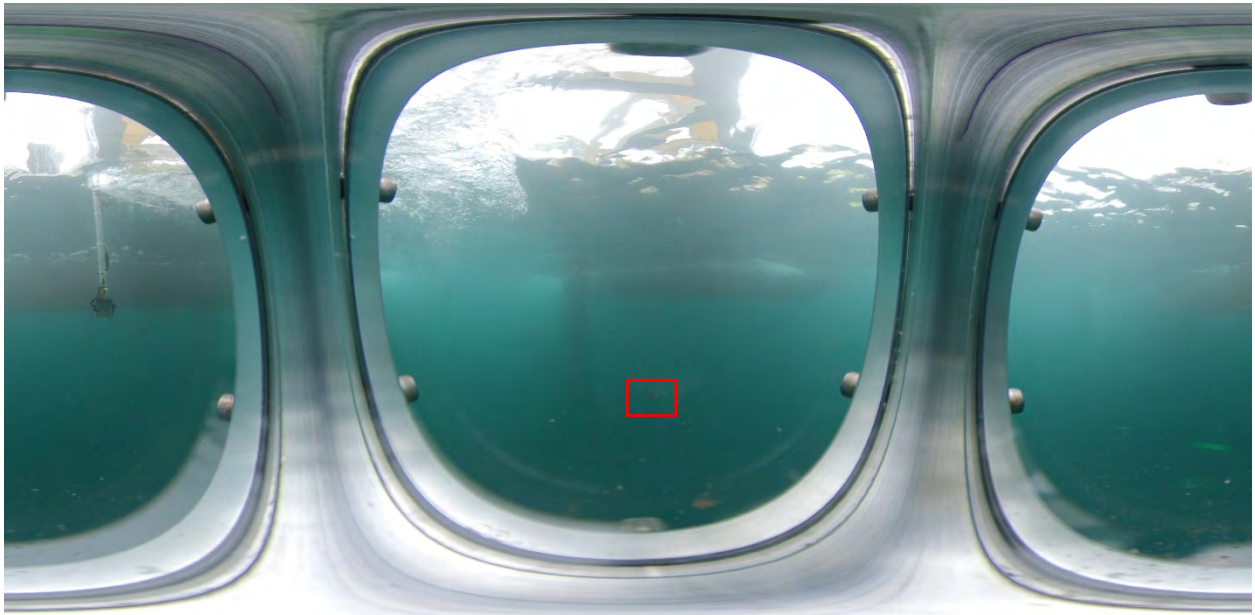

*Appendix B Deployment 4 Still 004.*

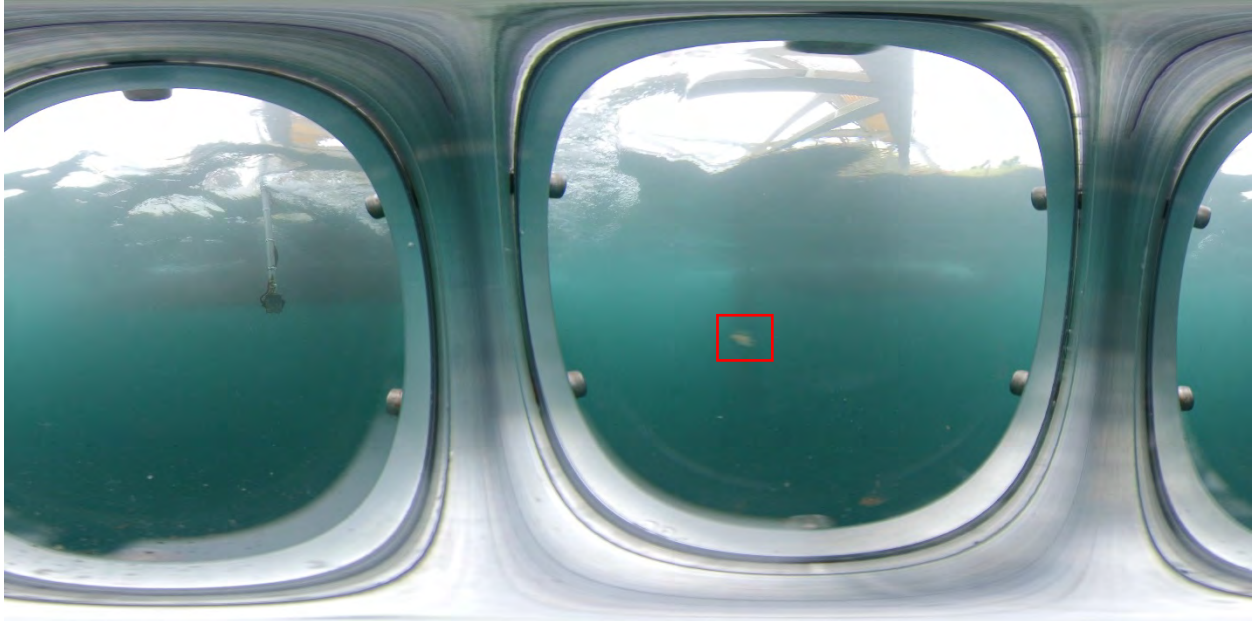

*Appendix B Deployment 4 Still 005.*

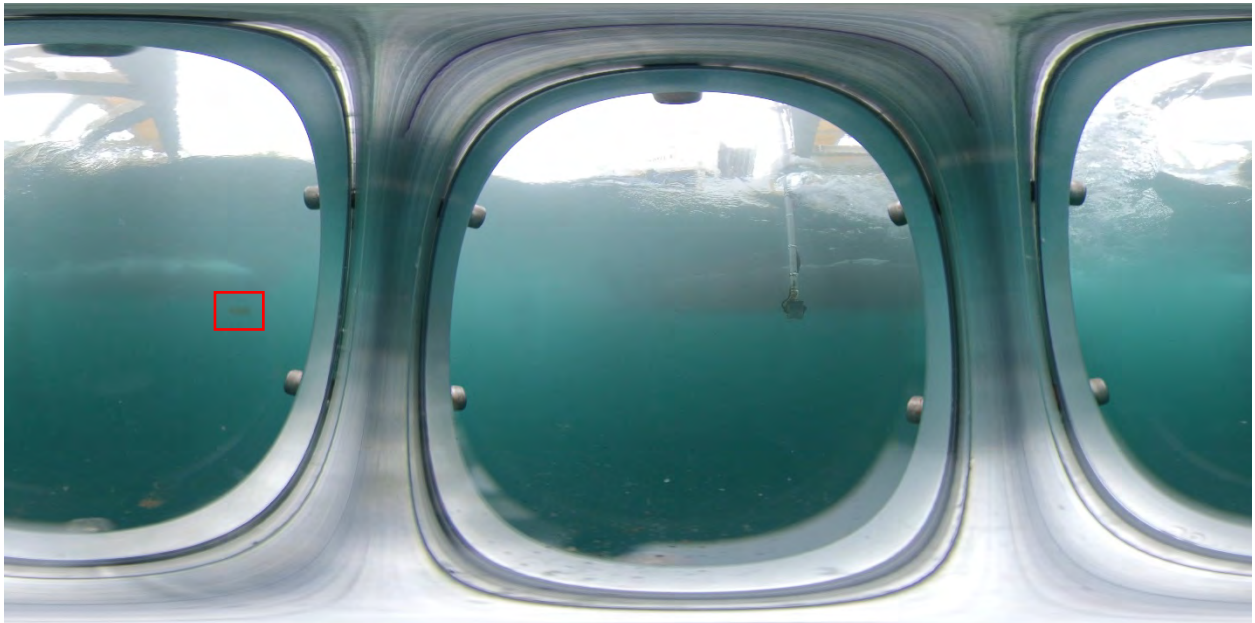

*Appendix B Deployment 2 Still 006.*

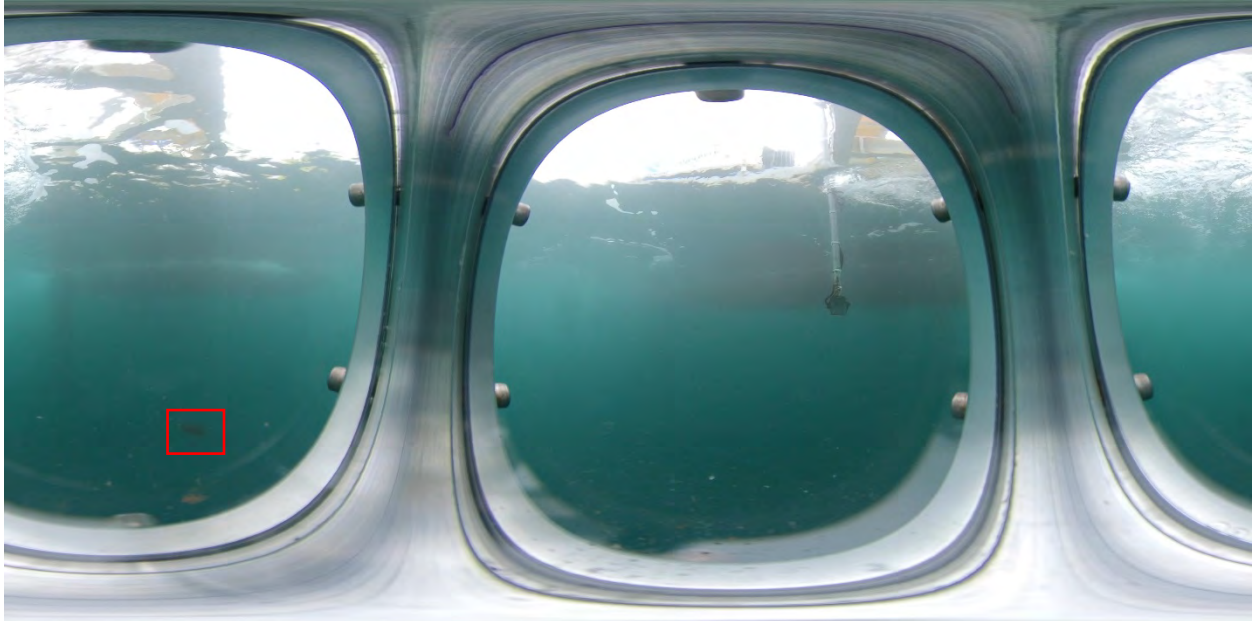

*Appendix B Deployment 4 Still 007.*

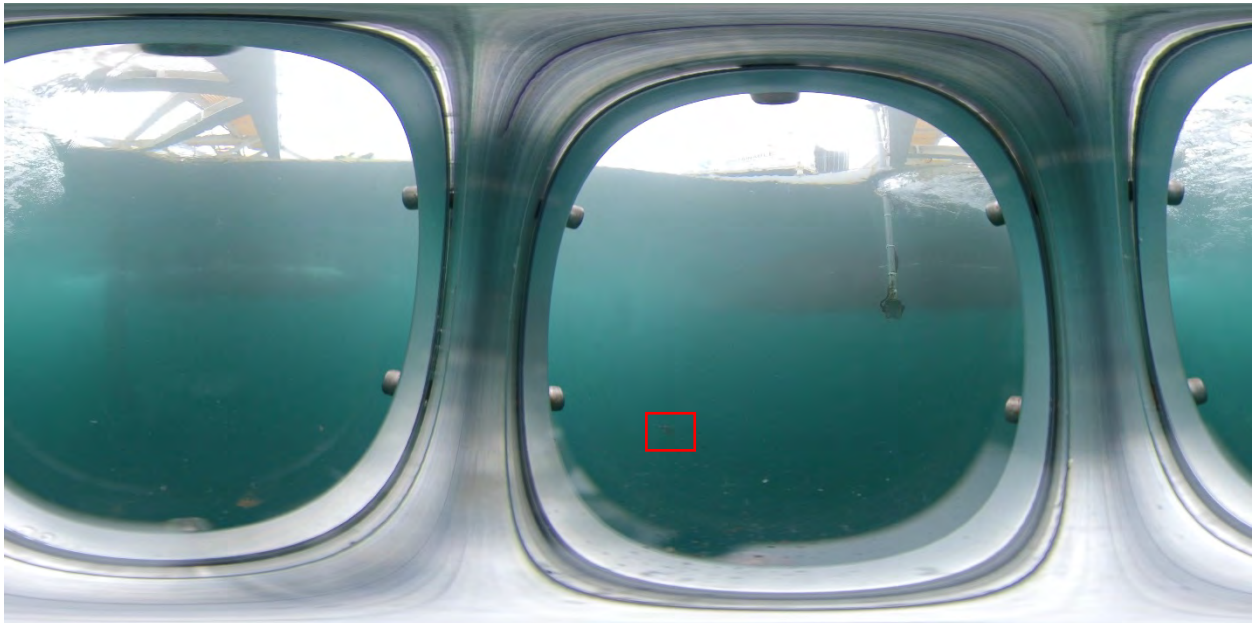

*Appendix B Deployment 4 Still 008.*



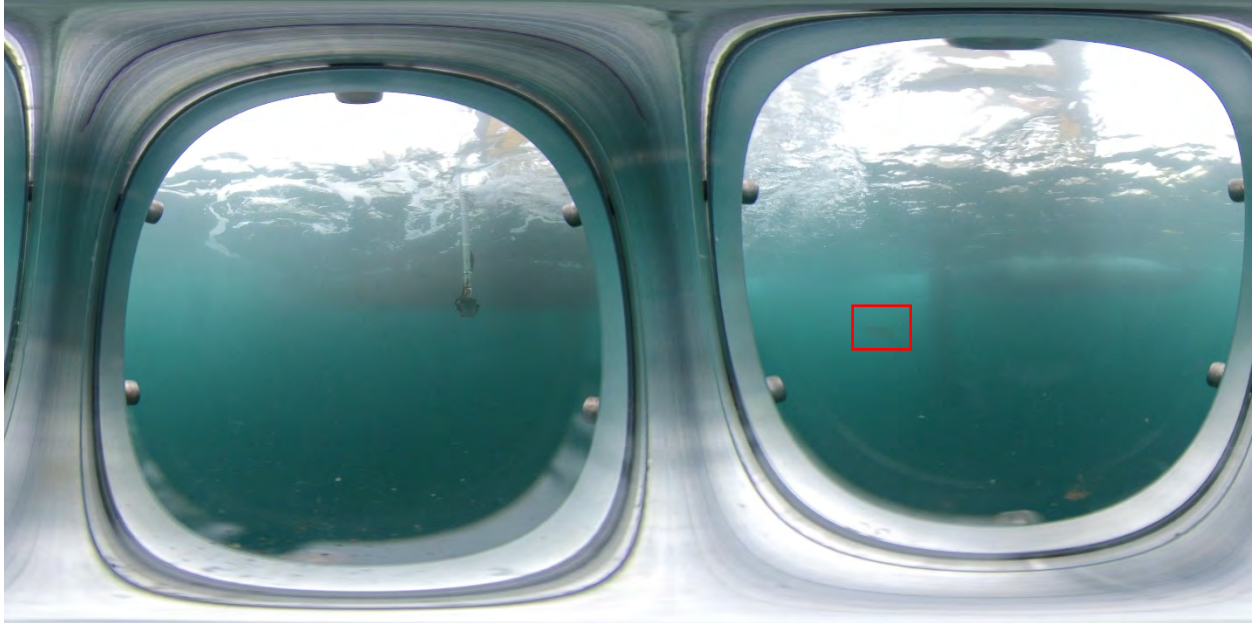

*Appendix B Deployment 4 Still 009.*

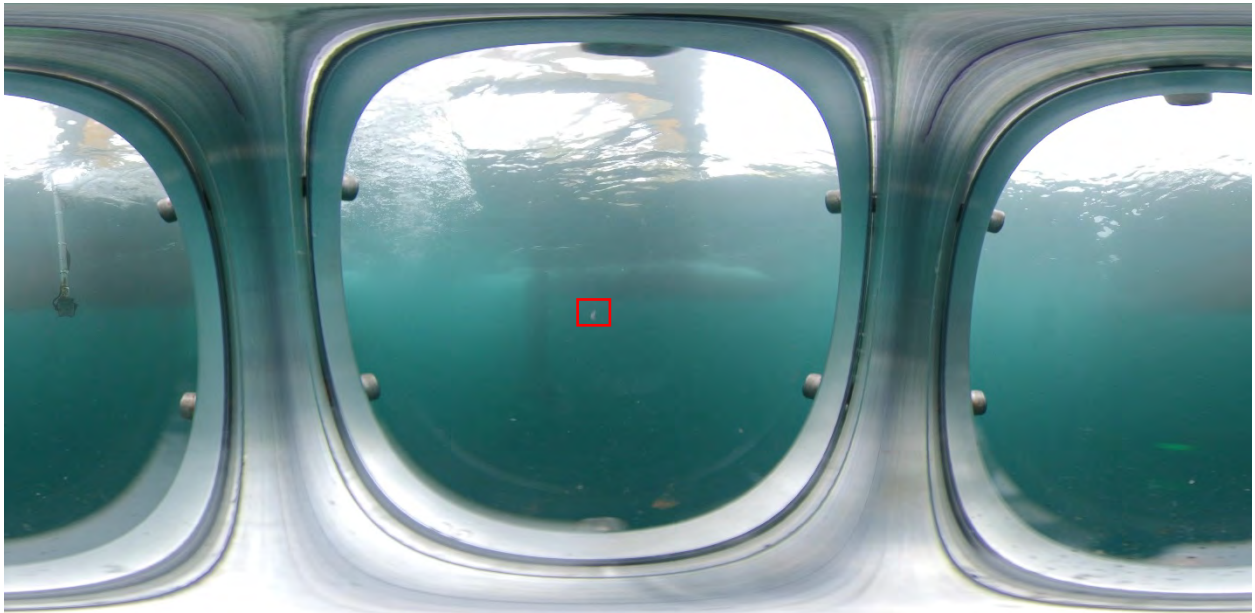

*Appendix B Deployment 4 Still 010.*

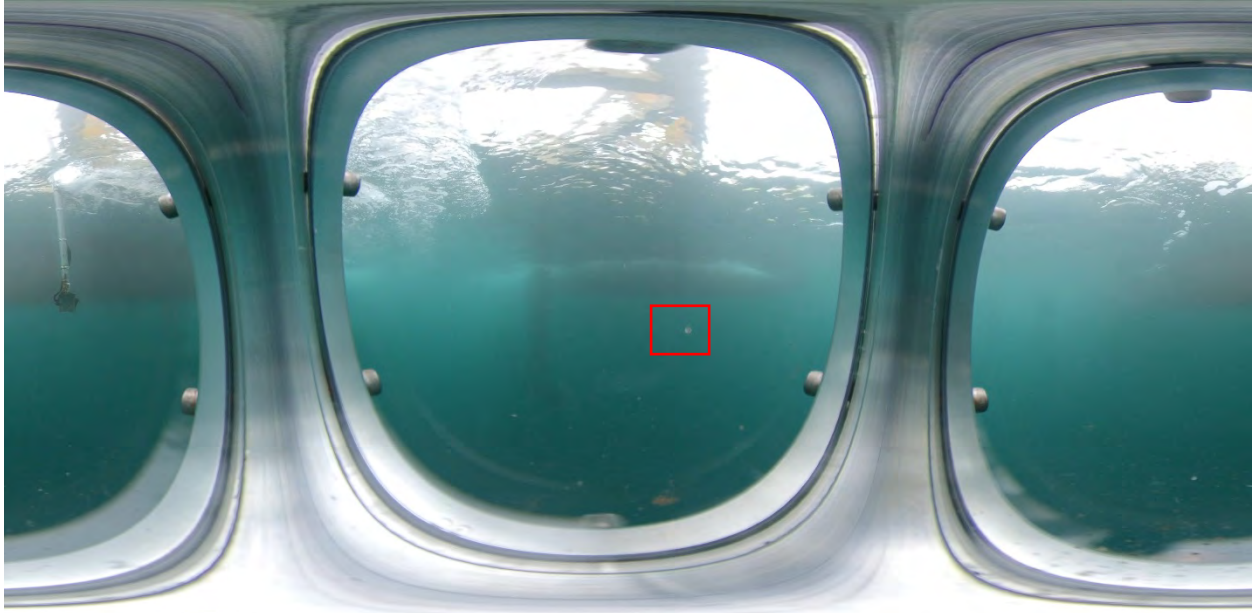

*Appendix B Deployment 4 Still 011.*

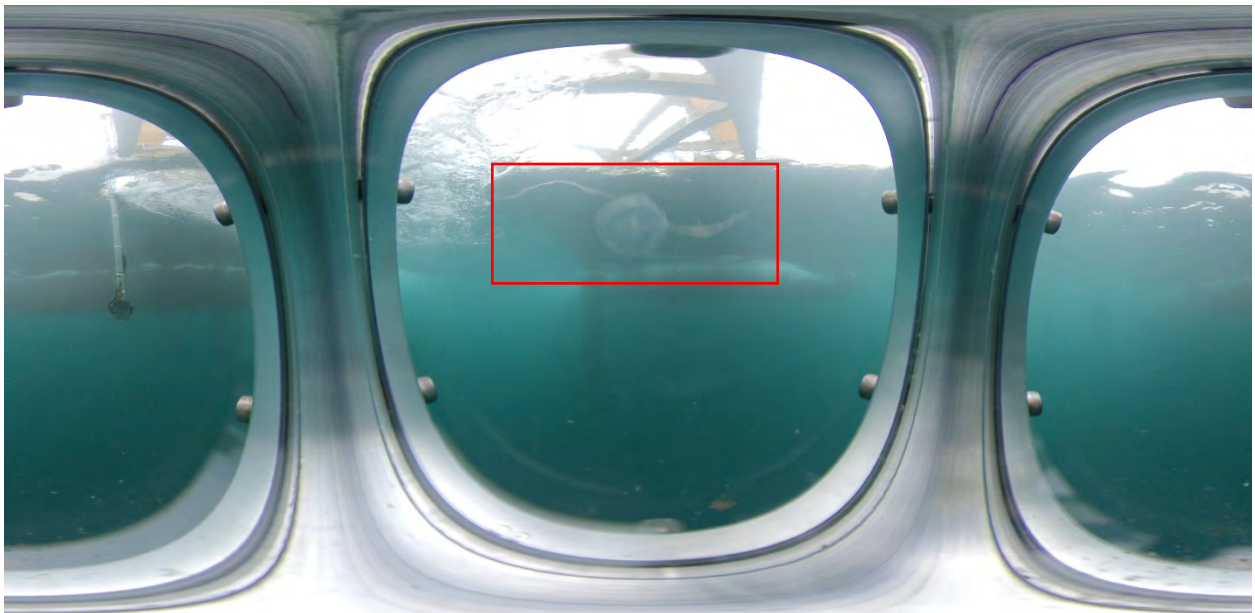

*Appendix B Deployment 4 Still 012.*

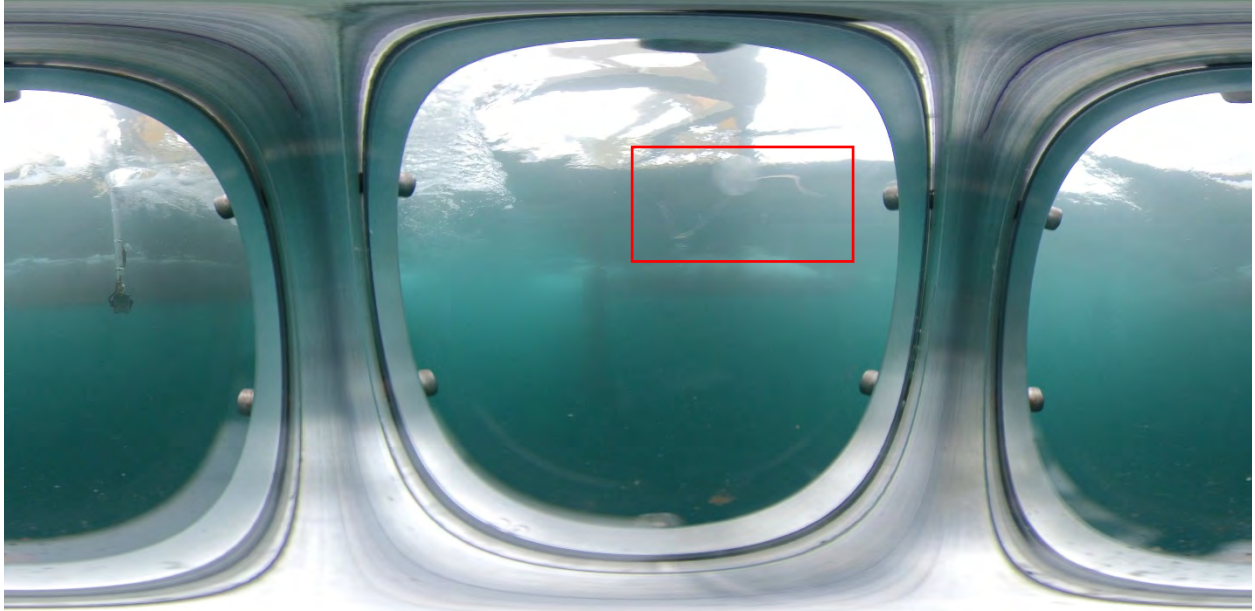

*Appendix B Deployment 4 Still 013.*

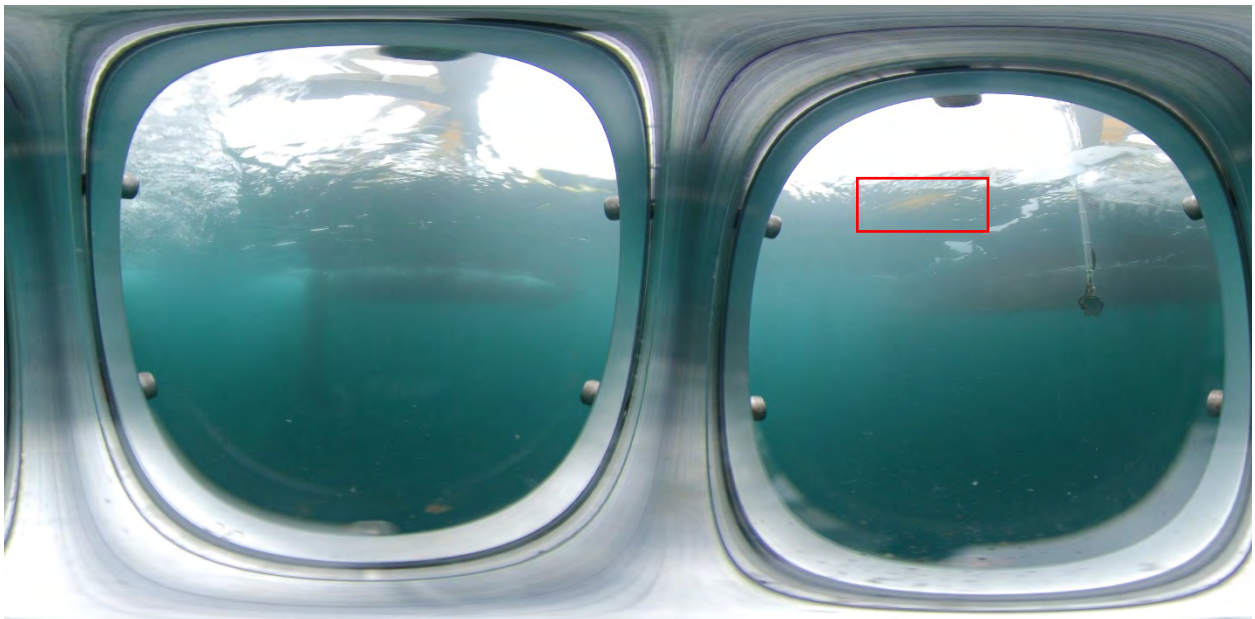

*Appendix B Deployment 4 Still 014.*

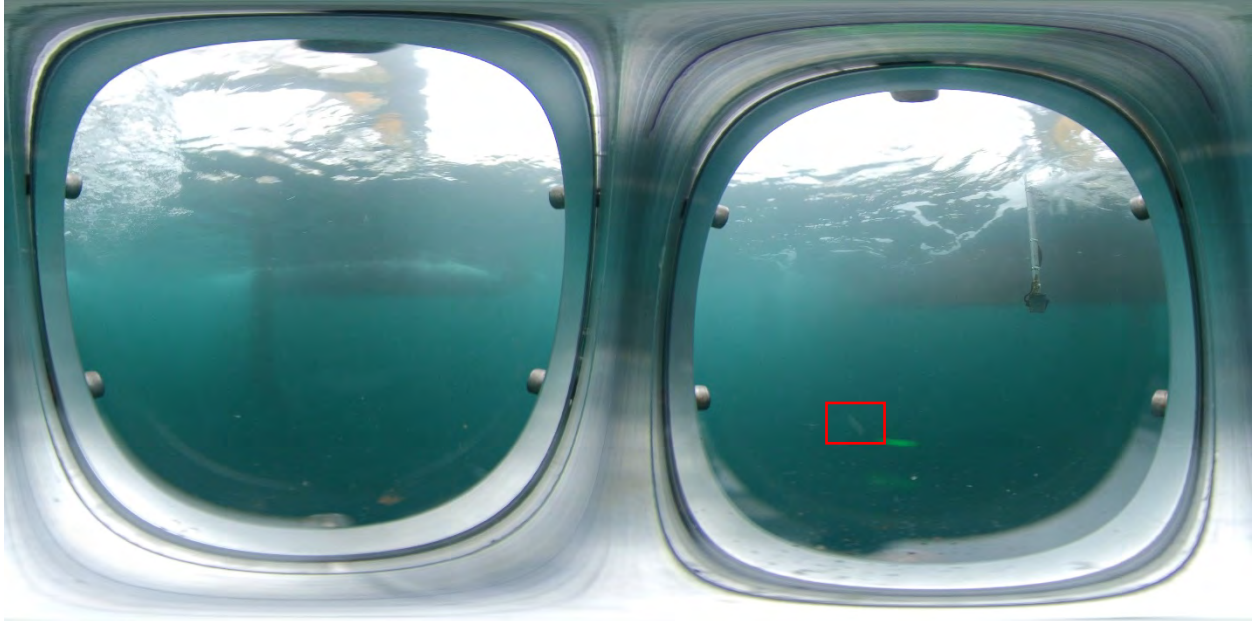

*Appendix B Deployment 4 Still 015.*

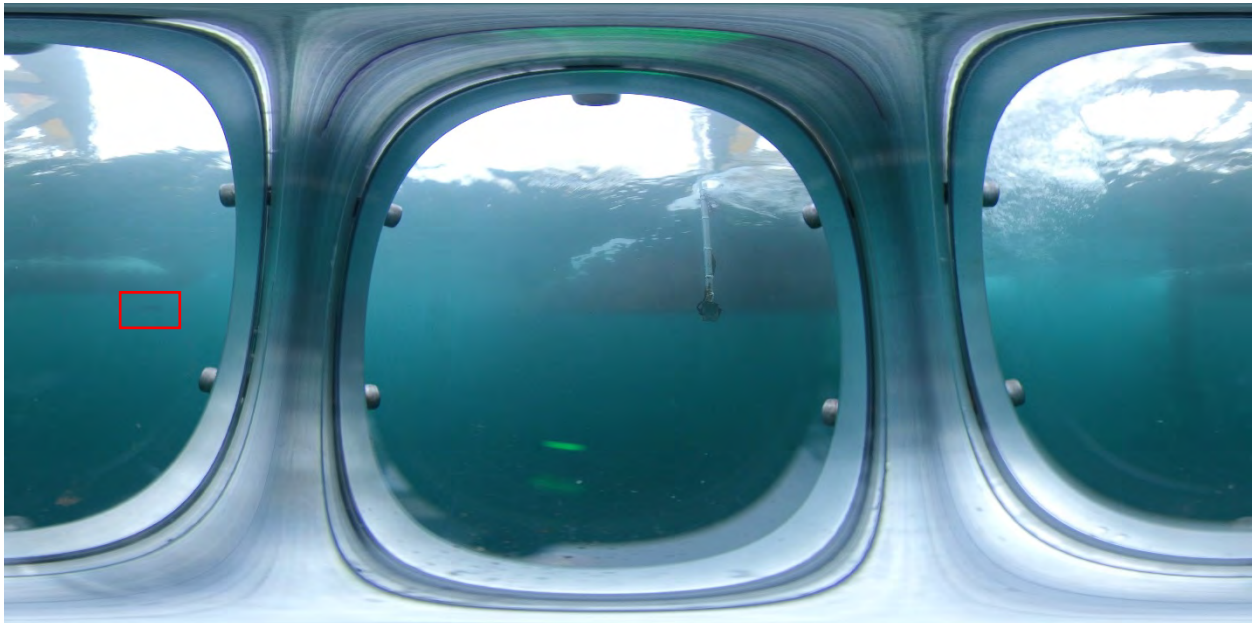

*Appendix B Deployment 4 Still 016.*

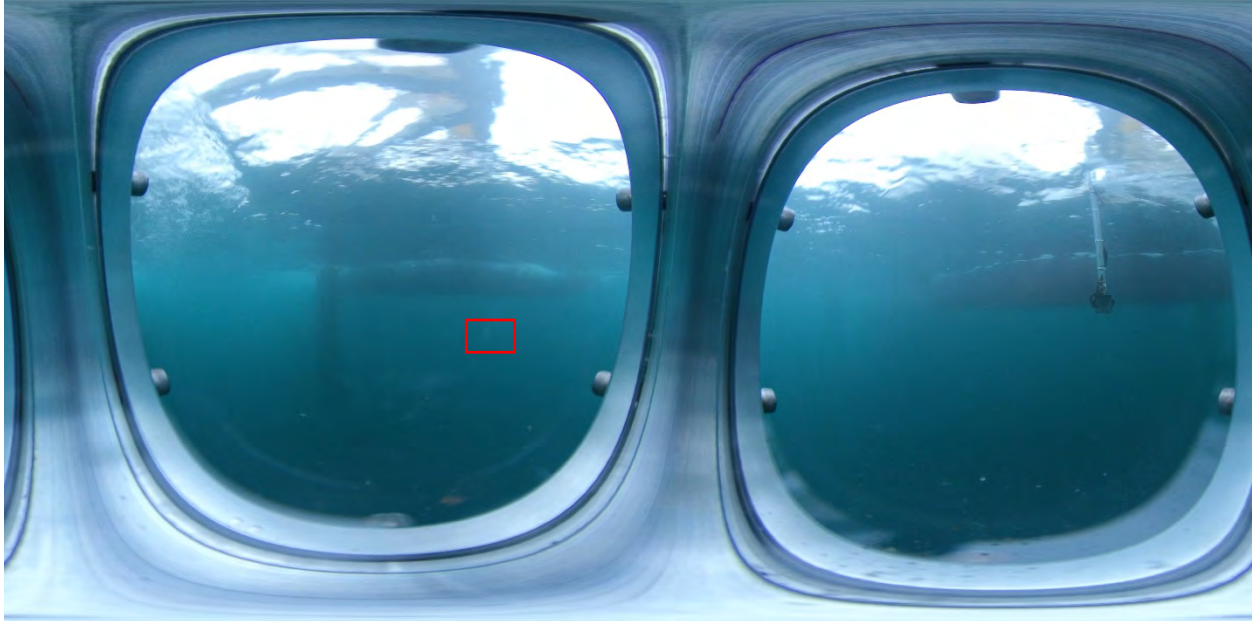

Appendix B Deployment 4 Still 017.

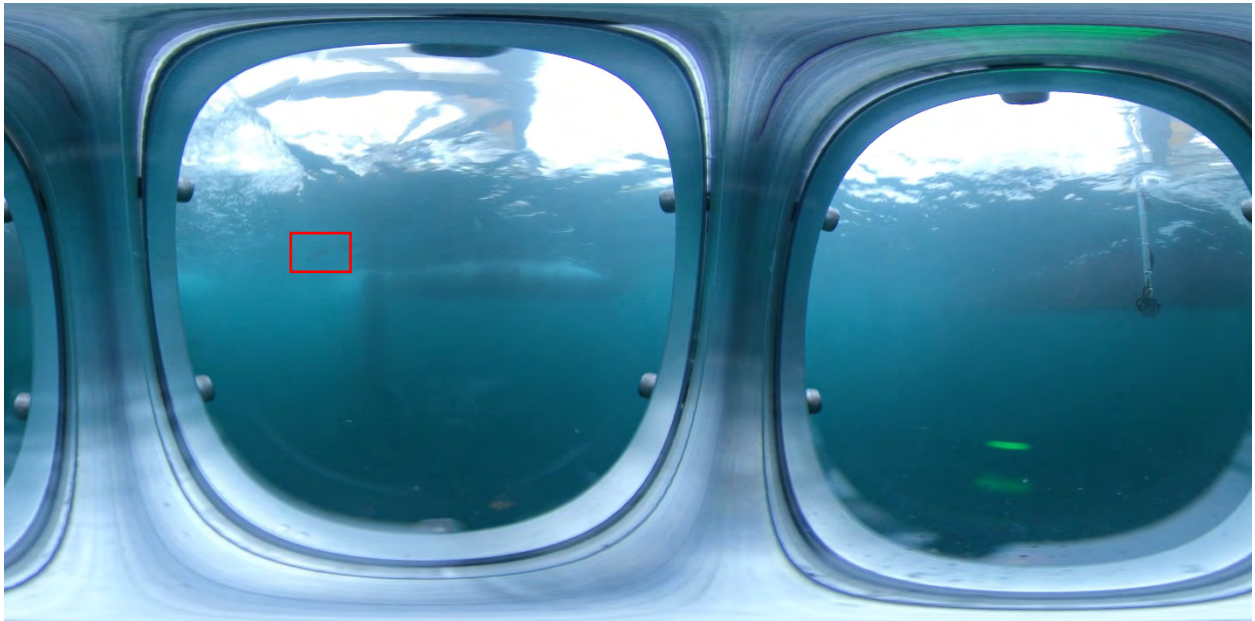

Appendix B Deployment 4 Still 018.

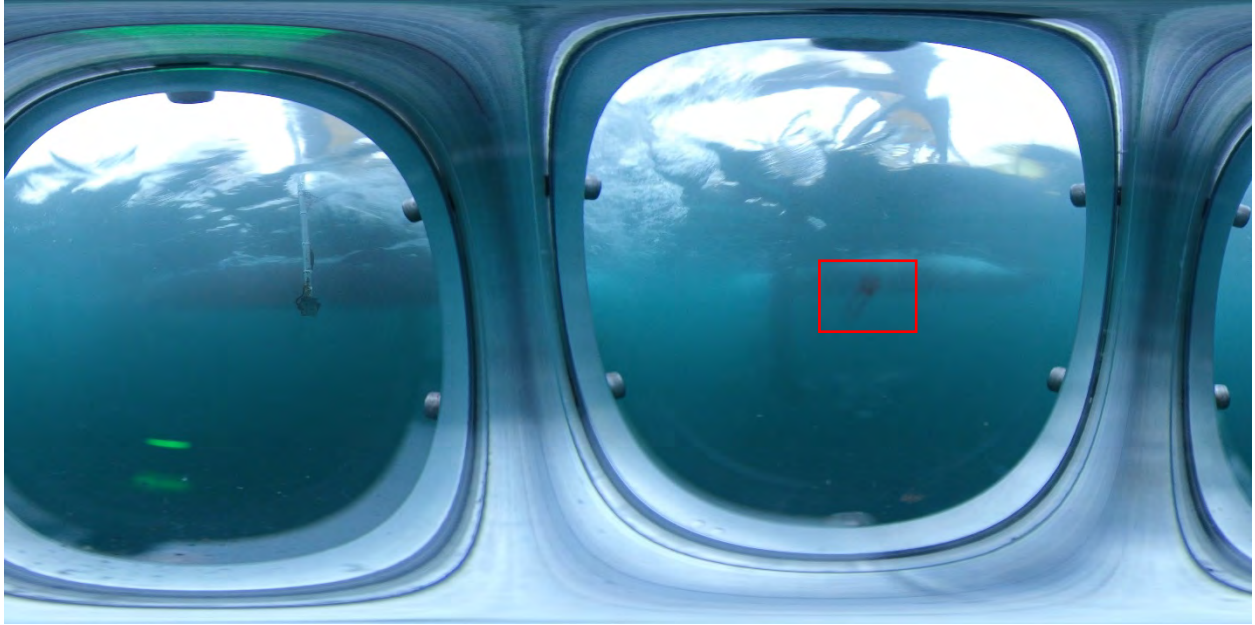

*Appendix B Deployment 4 Still 019.*

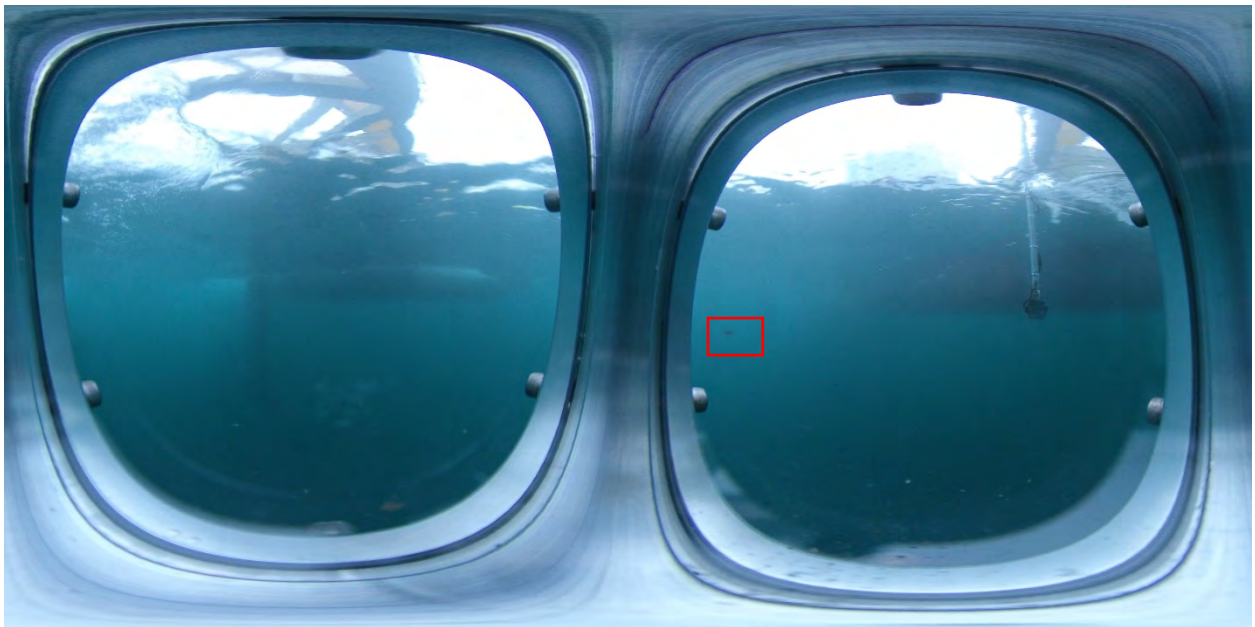

*Appendix B Deployment 4 Still 020.*



*Appendix B Deployment 4 Still 021.*

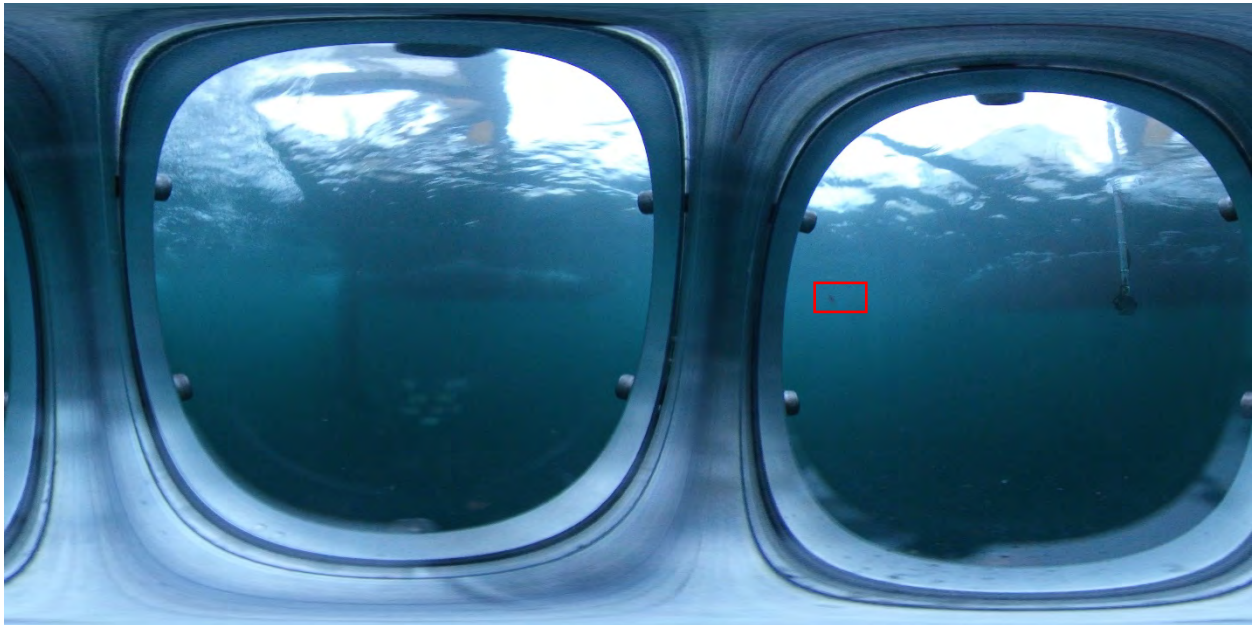

*Appendix B Deployment 4 Still 022.*

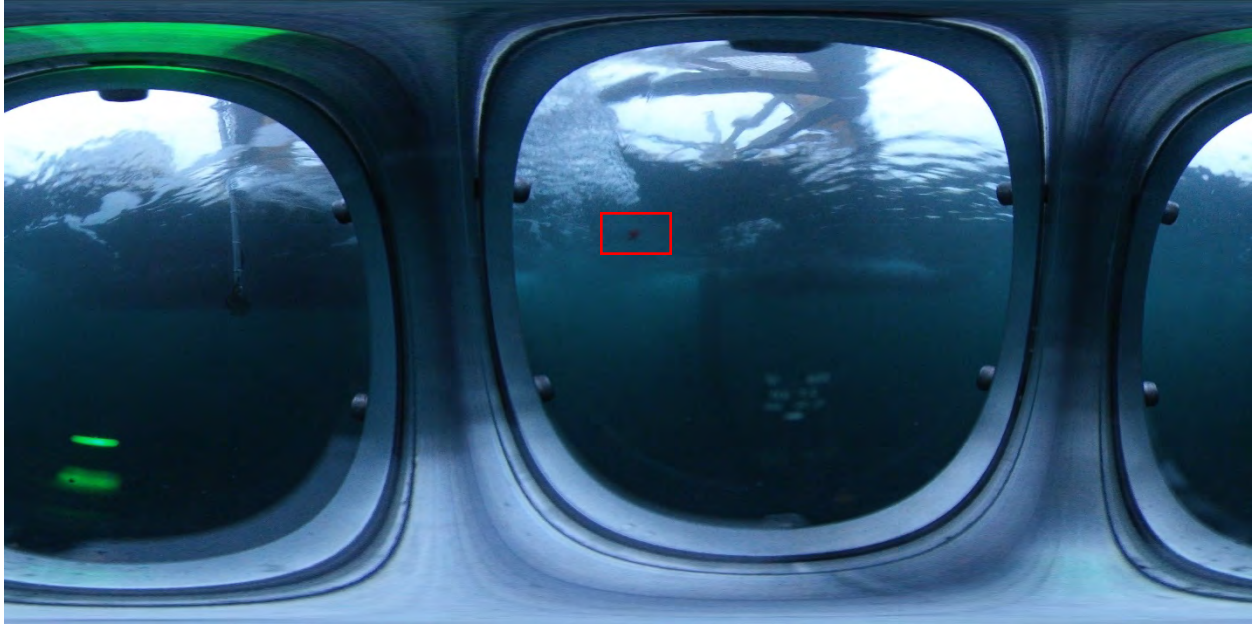

*Appendix B Deployment 4 Still 023.*



*Appendix B Deployment 5 Still 001.*





*Appendix B Deployment 5 Still 002.*



*Appendix B Deployment 5 Still 003.*



*Appendix B Deployment 5 Still 004.*



*Appendix B Deployment 5 Still 005.*

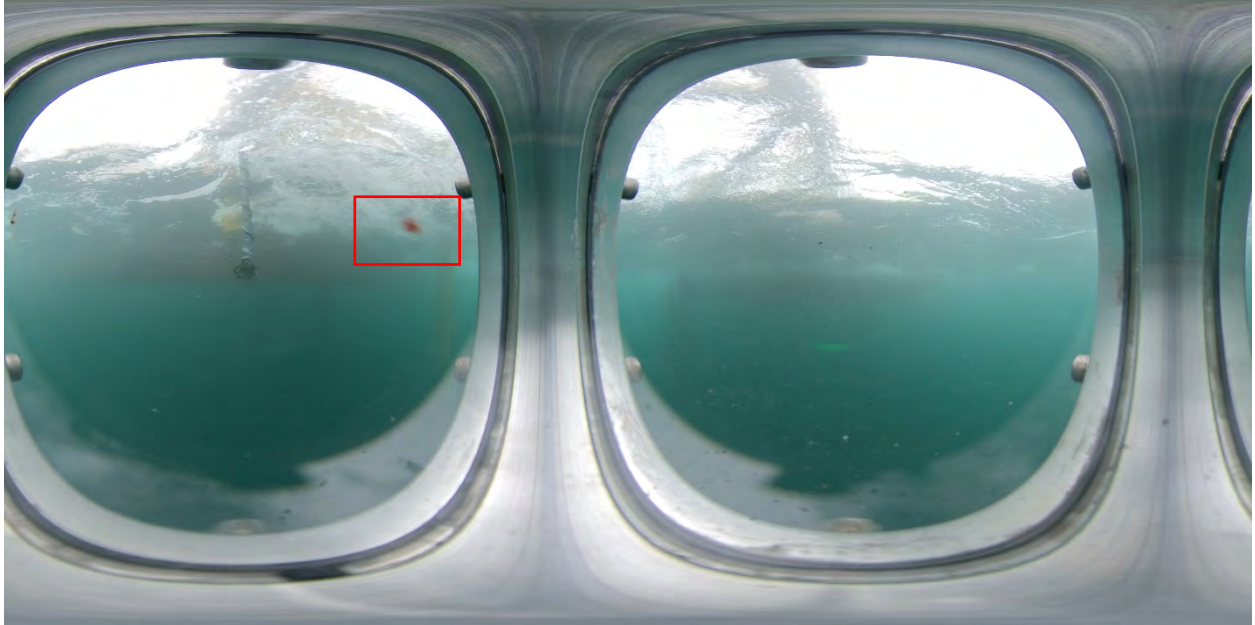

*Appendix B Deployment 6 Still 001.*

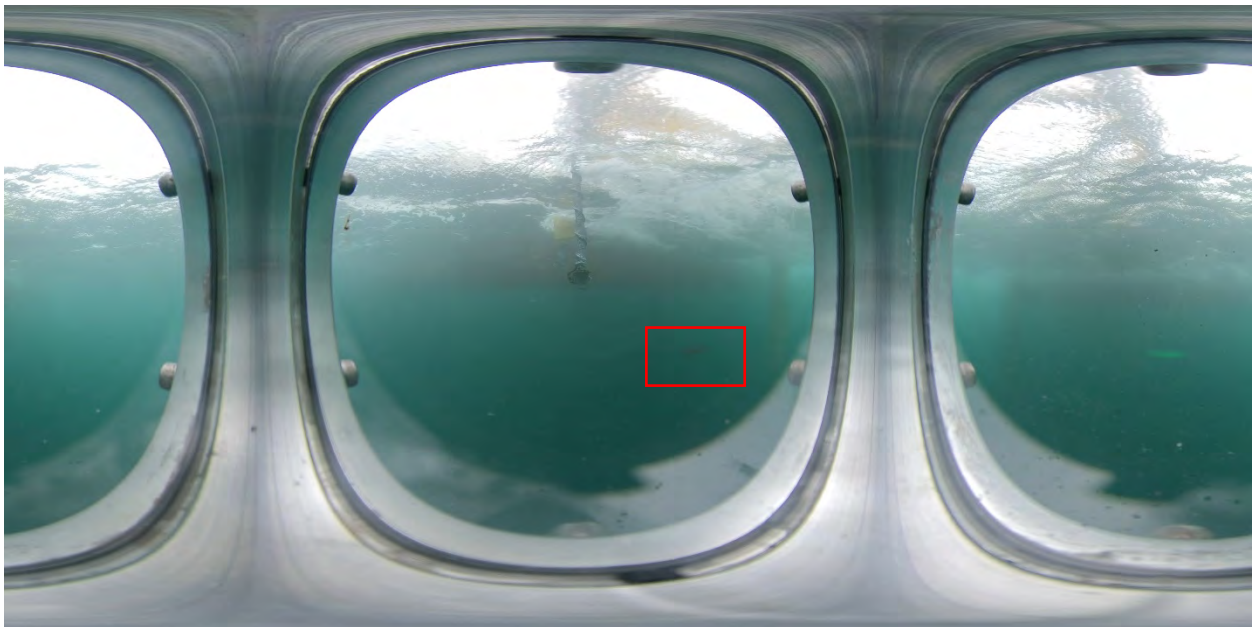

*Appendix B Deployment 6 Still 002.*

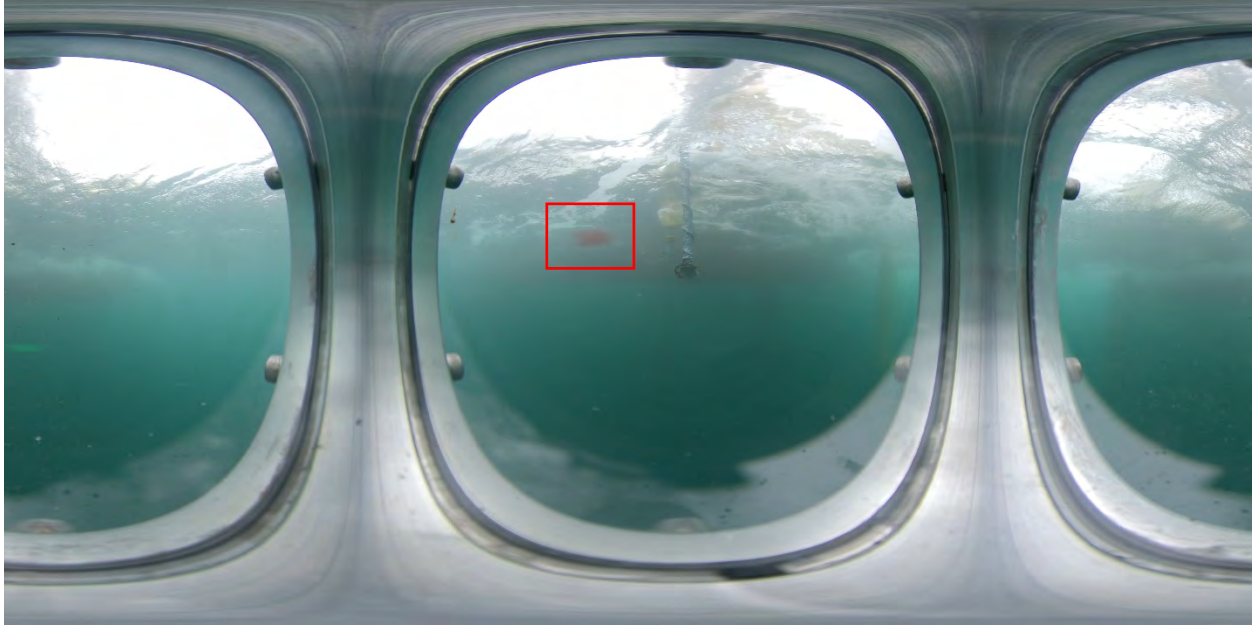

*Appendix B Deployment 6 Still 003.*

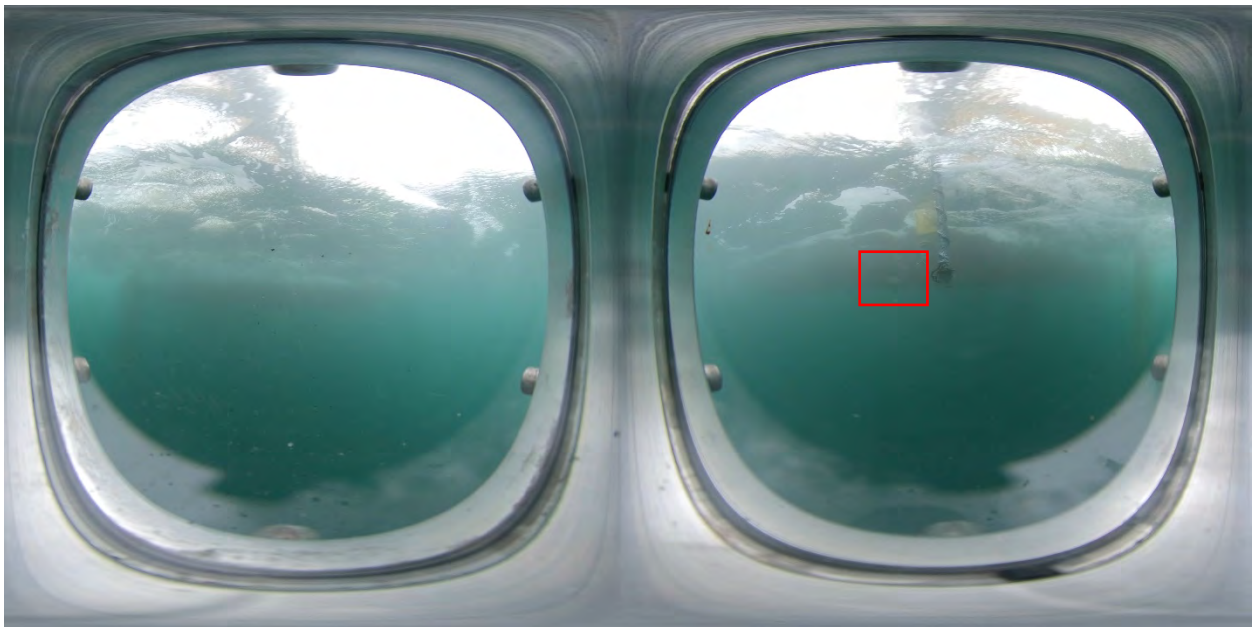

*Appendix B Deployment 6 Still 004.*



*Appendix B Deployment 6 Still 005.*

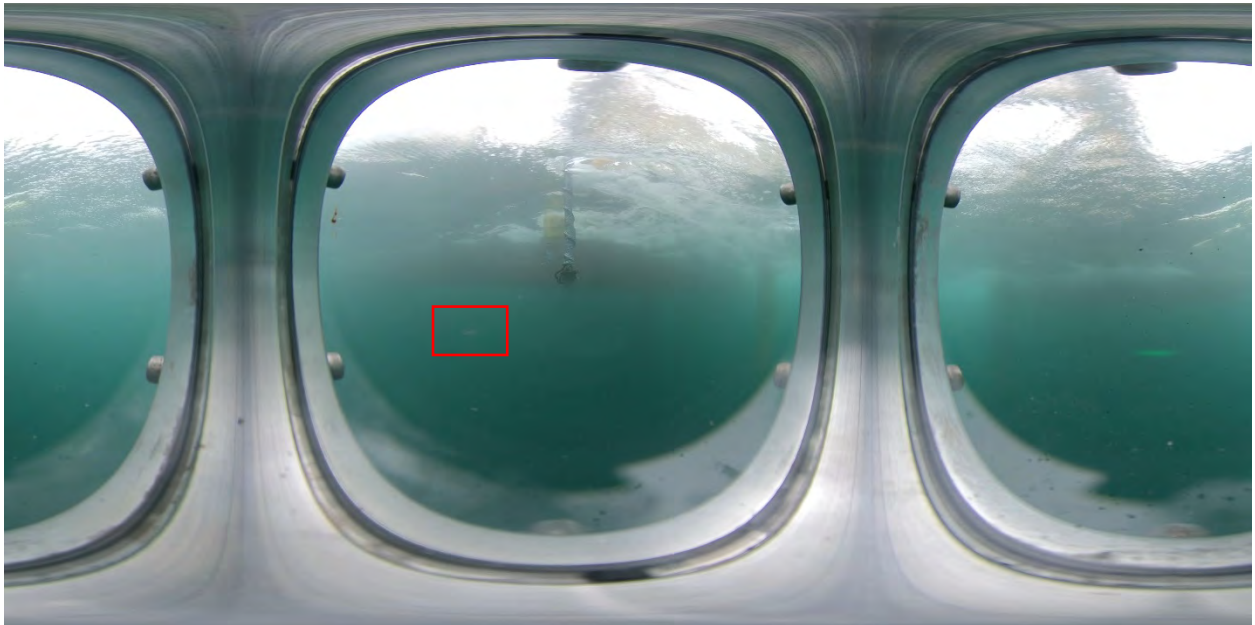

*Appendix B Deployment 6 Still 006.*

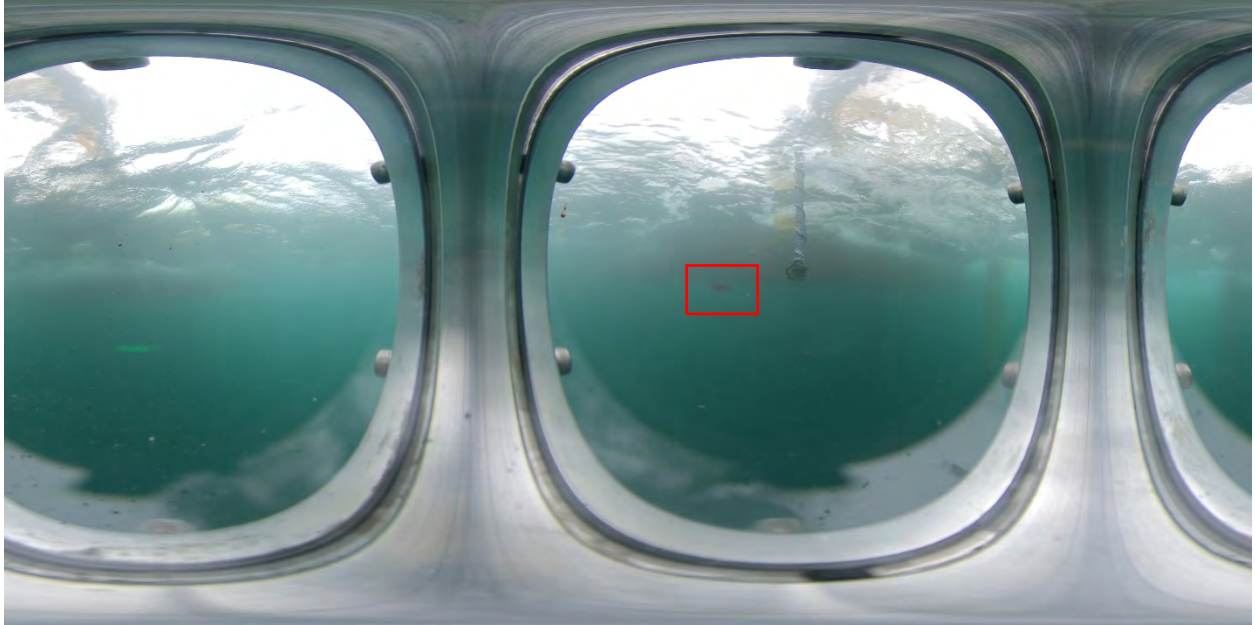

*Appendix B Deployment 6 Still 007.*

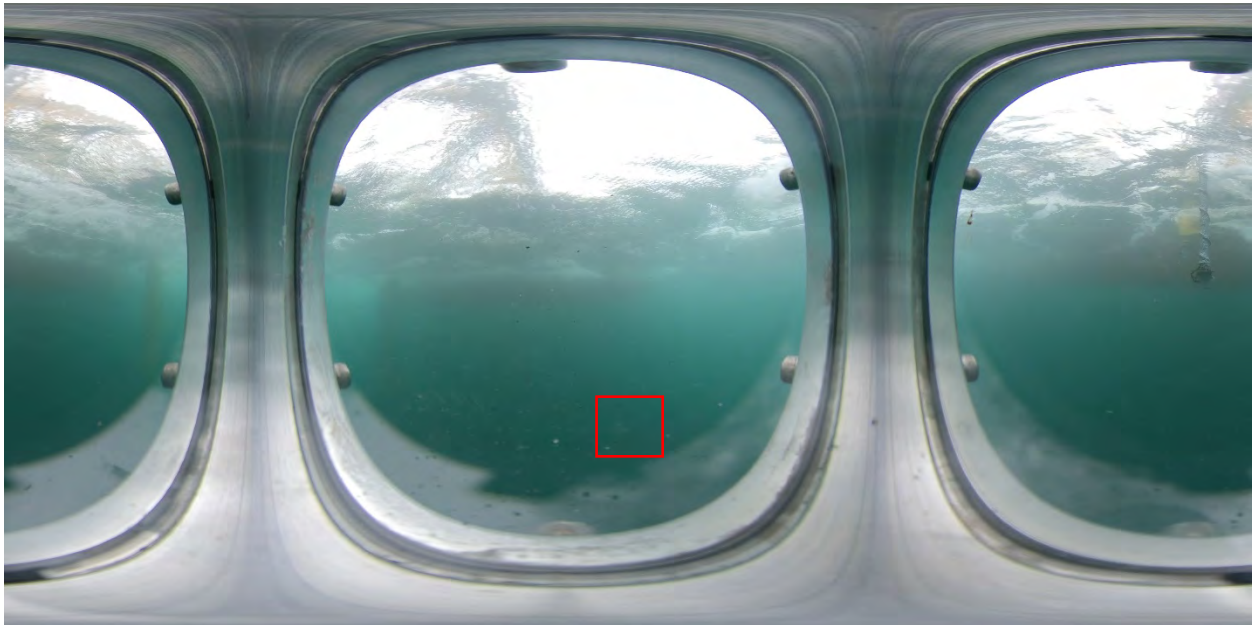

*Appendix B Deployment 6 Still 008.*

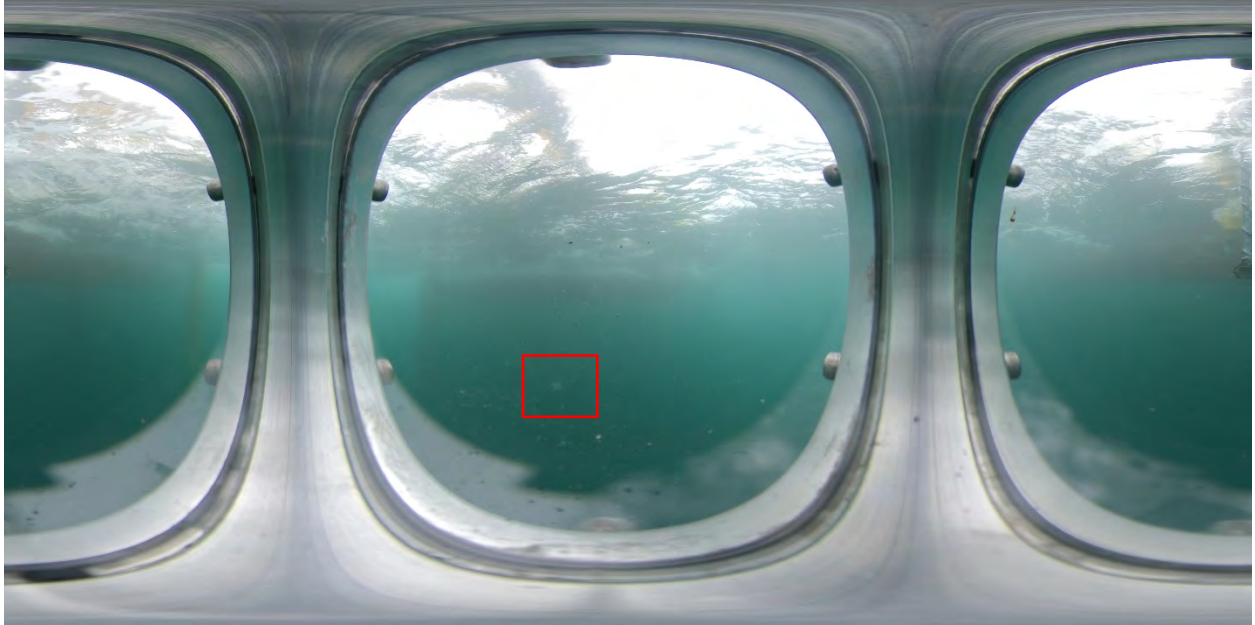

*Appendix B Deployment 6 Still 009.*

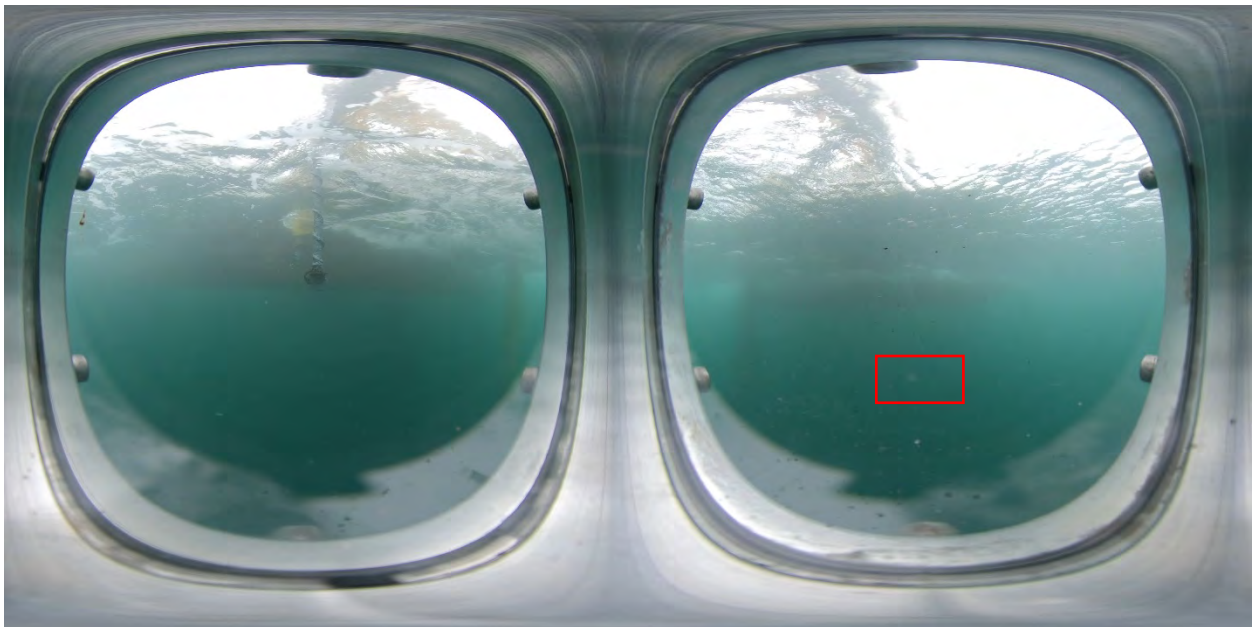

*Appendix B Deployment 6 Still 010.*

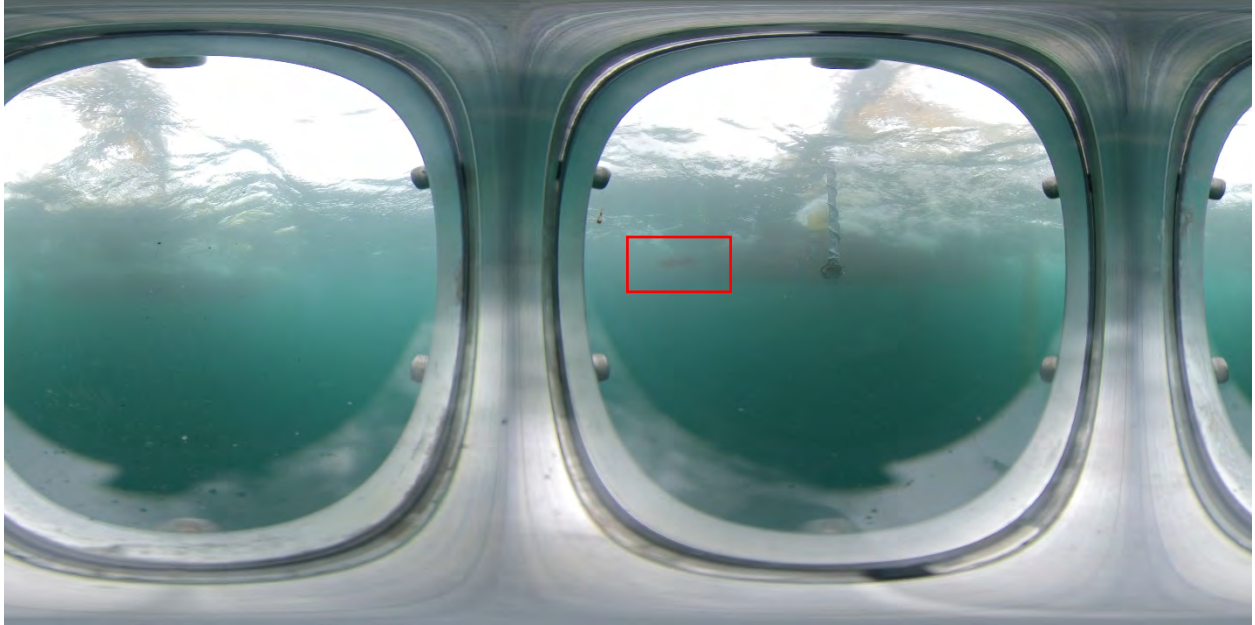

*Appendix B Deployment 6 Still 011.*

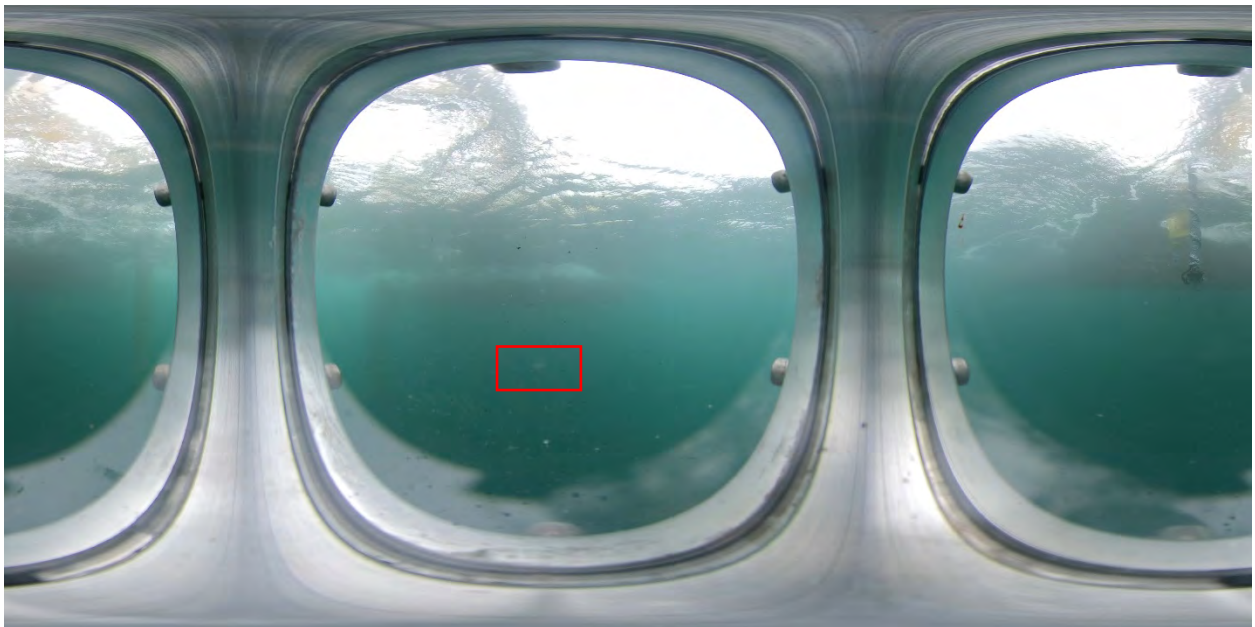

*Appendix B Deployment 6 Still 012.*



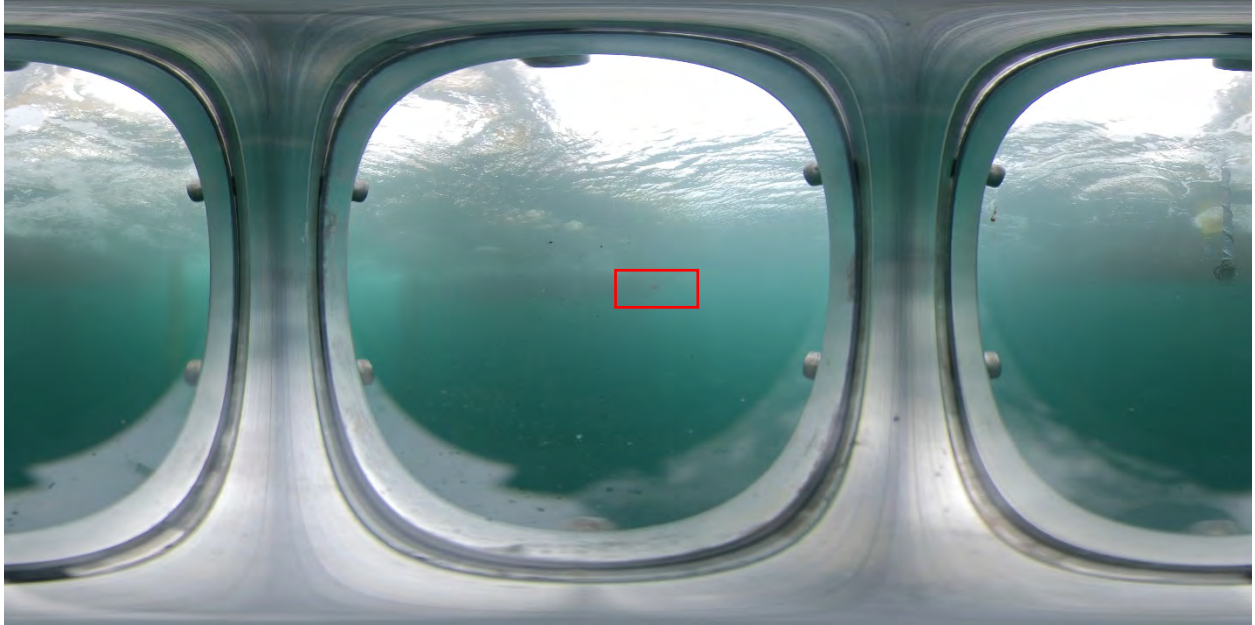

*Appendix B Deployment 6 Still 013.*

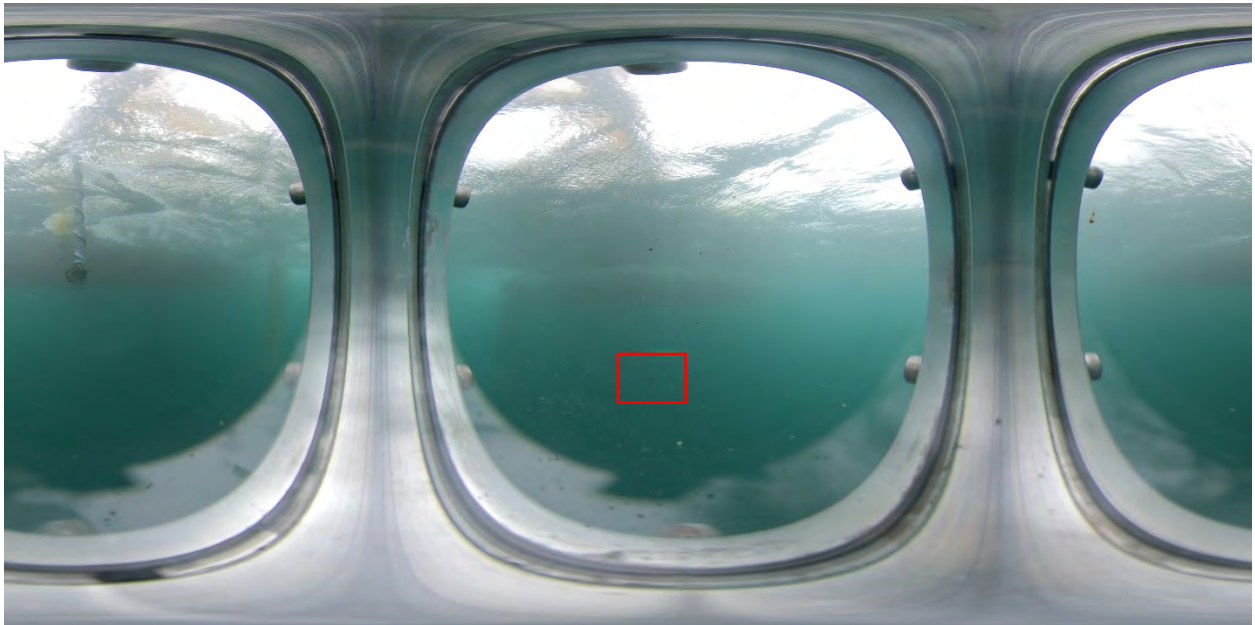

*Appendix B Deployment 6 Still 014.*