

**A RADAR STUDY OF NOCTURNAL BIRD MIGRATION AT THE
PROPOSED MOUNT STORM WIND POWER DEVELOPMENT,
WEST VIRGINIA, FALL 2003**

FINAL REPORT

Prepared for
Western Ecosystems Technology, Inc.
Cheyenne, Wyoming
and
NedPower US LLC
Chantilly, Virginia

Prepared by
Todd J. Mabee
Brian A. Cooper
Jonathan H. Plissner
ABR, Inc.—Environmental Research & Services
Forest Grove, Oregon

March 2004



Printed on recycled paper.

EXECUTIVE SUMMARY

- This report presents the results of a radar study of bird migration conducted during 3 September–17 October 2003 at the proposed Mt. Storm wind power development, located in northeastern West Virginia. Radar observations were conducted for ~6 h/night on 45 nights.
- The primary objectives of this study were to (1) collect baseline information on flight directions, migration passage rates, and flight altitudes of nocturnal passerine migrants at the proposed project area during fall 2003; (2) determine if nocturnal migrants concentrate along the proposed Allegheny Front within the project area; and (3) determine if there is variation in the amount or altitude of migrants at up to three locations along the ridge at a 1,500 m radius scale.
- At night, the mean flight direction of targets observed on radar was $184^\circ \pm 1^\circ$.
- Nocturnal passage rates were highly variable among nights during fall 2003, ranging from 8 to 852 targets/km/h. The mean nocturnal passage rate for the season was 241 ± 33 targets/km/h at the primary (central) study site and was estimated to be 199 targets/km/h for the entire proposed development area. Passage rates varied among hours of the night during fall 2003.
- Mean flight altitudes observed on radar were highly variable among nights during fall 2003. The mean nocturnal flight altitude was 410 ± 2 m agl. There were hourly differences in flight altitude among hours of the night in fall 2003, with lower altitudes occurring later in the evening. Overall, we estimated that 13% of nocturnal targets flew below 125 m agl across the length of the ridge encompassing the proposed development area.
- We calculated a mean passage rate of 36.3 targets/km/h flying below 125 m agl (or 2.91×10^{-4} targets/m²/h) at the proposed development, for the fall passerine migration season.
- We found no strong correlations between NEXRAD reflectivity values (representing bird densities) and radar migration passage rates during 25 nights with comparable data. Mean flight directions of radar targets, however, were correlated with the direction of migration.
- The key results of our study include the following: (1) relatively high mean passage rates (i.e., 199 targets/km/h ridge-wide); (2) approximately 20% of nights with passage rates much higher than the mean rate for the fall season; (3) variation in passage rates among some ridge sites (central:southern) and between ridge and off-ridge sites (central:western); (4) the weight of evidence suggesting that migrants did not concentrate along the Allegheny Front in fall 2003; (5) similar mean flight altitudes among sites (excluding valley); and (6) 13% of targets < 125 m agl ridge-wide, which is higher than the small number of comparable studies.

TABLE OF CONTENTS

EXECUTIVE SUMMARY	i
LIST OF FIGURES	iii
LIST OF TABLES	iv
LIST OF APPENDICES	iv
ACKNOWLEDGMENTS	iv
INTRODUCTION	1
OBJECTIVES	1
STUDY AREA	1
METHODS	4
STUDY DESIGN	4
RADAR EQUIPMENT	4
DATA COLLECTION	5
TARGET IDENTIFICATION	5
SAMPLING DESIGN	6
DATA ANALYSES	7
TREATMENT OF RADAR DATA	7
SITE COMPARISONS	8
RIDGE-WIDE PASSAGE RATES	8
RESULTS	8
CENTRAL SITE	8
FLIGHT DIRECTION	8
FLIGHT BEHAVIOR	8
PASSAGE RATES	10
FLIGHT ALTITUDES	10
FLIGHT SPEEDS	13
SITE COMPARISONS	13
FLIGHT DIRECTIONS	13
MEAN PASSAGE RATES	13
MEAN FLIGHT ALTITUDES	13
RIDGE-WIDE PASSAGE RATES	13
DISCUSSION	14
FLIGHT DIRECTIONS	14
TIMING OF MIGRATION	14
PASSAGE RATES	16
FLIGHT ALTITUDES	16
DID MIGRANTS CONCENTRATE ALONG THE ALLEGHENY FRONT?	18
CONCLUSIONS	18
LITERATURE CITED	18

LIST OF FIGURES

Figure 1. Map of the proposed Mt. Storm wind power development in West Virginia.	2
Figure 2. Map of the radar sampling sites and proposed wind turbines at the proposed Mt. Storm wind power development, West Virginia.	3
Figure 3. Flight directions of radar targets at the Mt. Storm central site, West Virginia, during fall 2003.	9

Figure 4.	Mean nightly passage rates at the Mt. Storm central site, West Virginia, during fall 2003.	10
Figure 5.	Percent of total nightly passage rates by hour of the night at the Mt. Storm central site, West Virginia, during fall 2003.	11
Figure 6.	Mean nightly flight altitudes at the Mt. Storm central site, West Virginia, during fall 2003.	11
Figure 7.	Mean flight altitude by hour of the night at the Mt. Storm central site, West Virginia, during fall 2003.	12
Figure 8.	Percent of targets by hour of the night and altitude at the Mt. Storm central site, West Virginia, during fall 2003.	12
Figure 9.	Mean nightly air speed at the Mt. Storm central site, West Virginia, during fall 2003.	14

LIST OF TABLES

Table 1.	Flight behavior of radar targets observed on surveillance radar at the Mt. Storm reference site, WV, during fall 2003.	9
Table 2.	Nocturnal flight altitudes of radar targets detected at the 1.5-km range at the Mt. Storm reference site, WV, during fall 2003.	13
Table 3.	A comparison of flight directions, overall passage rates, and flight altitudes of radar targets at the central and other sites near Mt. Storm, WV, during fall 2003.	15

LIST OF APPENDICES

Appendix 1.	Calculation of total numbers of birds within proposed turbine height for the minimal number of turbines over the entire 45-day fall 2003 study period at the proposed Mt. Storm wind-power development, WV.	23
Appendix 2.	Paired comparisons of nocturnal flight directions of radar targets from sites at Mt. Storm, WV, during fall 2003.	25
Appendix 3.	Paired comparisons of mean nightly passage rates of radar targets between sites at Mt. Storm, WV, during fall 2003.	27
Appendix 4.	Paired comparisons of mean nightly flight altitudes of radar targets from sites at Mt. Storm, West Virginia, during fall 2003.	29
Appendix 5.	AIC modeling of the effects of weather on migration passage rates and flight altitudes at Mt. Storm, West Virginia, during fall 2003.	31
Appendix 6.	NEXRAD weather comparisons at Mt. Storm, West Virginia, during fall 2003.	38

ACKNOWLEDGMENTS

We thank NedPower for funding this study and Dale Strickland, Dave Young, and Wally Erickson (WEST, Inc.) for providing input on study design, coordinating field activities, and report review. We thank Ron Canterbury and Dave Young for help with selection of study sites. At ABR, we thank Peter Sanzenbacher and Corey Grinnell for help with radar sampling and report preparation; Amy Bradford, Jen Felkay, and Pam Odom for help in report preparation; Rich Blaha for figure preparation; and Bob Day for reviewing the report.

INTRODUCTION

Records of avian collisions with communication towers in North America have been documented since 1948 (Kerlinger 2000, Manville 2000), with sporadic occurrences of large mortality events reported, especially at taller structures (e.g., guyed and lighted towers >130 m high) on foggy, overcast nights in fall (Weir 1976, Avery et al. 1980, Evans 1998, Erickson et al. 2001). Nocturnal migrants also have been recorded colliding with wind turbines (Osborn et al. 2000, Erickson et al. 2001), although large kills of migratory birds have not been documented at wind power developments. Studies examining the impacts of wind turbines on birds in the US and Europe suggest that important fatality and behavioral events (e.g., avoidance of areas with wind turbines) occur in some, but not all, locations (Winkelman 1995, Anderson et al. 1999, Erickson et al. 2001). Therefore, an understanding of the dynamics of nocturnal bird migration at specific locations is necessary to assess the potential for bird collisions with tall, human-made structures. Consideration of nocturnal migration is particularly important because considerably more birds migrate at night than during the daytime (Gauthreaux 1975, Kerlinger 1995).

In particular, neotropical migratory birds such as thrushes (Turdidae) vireos (Vireonidae), and warblers (Parulidae) seem to be the most vulnerable to collisions with communication towers during their nocturnal migrations (Manville 2000). Such passerines (“songbirds”) also comprise >80% of fatalities at wind power developments (Erickson et al. 2001), with ~50% of those fatalities involving nocturnal migrants. Passerines may be more at risk of colliding with structures at night because these birds tend to migrate at lower altitudes than do other groups of migratory birds (e.g., waterfowl, shorebirds; Kerlinger 1995).

The Eastern US contains mountains, rivers, wetlands, and coastal habitats that may influence the migration patterns of birds (Zalles and Bildstein 2000, Williams et al. 2001, Diehl et al. 2003). Although West Virginia contains several known migration corridors for diurnally-migrating birds (Heintzelmann 1975, Bellrose 1976, Zalles and Bildstein 2000), few comparable data are

available for nocturnal migration there. Both the lack of information on nocturnal bird migration in general and ongoing bird fatalities at most wind power facilities studied in the US (Erickson et al. 2001) have generated concern about the potential of collisions between nocturnal migrants and the proposed Mt. Storm Wind Power Development in northeastern West Virginia (Fig.1). NedPower proposes to build the Mt. Storm Wind Power Project, a ~300 MW wind power development along the Allegheny Front ridgeline (Fig. 2). The proposed development is located on the Allegheny Front, a ridgeline known for its importance for diurnally-migrating birds including raptors and passerines (Hall and Bell 1981). The proposed Mt. Storm Wind Power Development would consist of ~150–200 wind turbines, each having a total height of up to 125 m.

We used a portable X-band radar system to study the main characteristics of nocturnal bird migration during fall 2003 at the proposed Mt. Storm Wind Power Development. Portable X-band radar systems are well-suited for studying nocturnal migration patterns at wind power development sites because they are uniquely able to provide local information about bird flight heights, direction, behavior, and passages rates that are useful for avian risk assessments. Evaluating the potential for avian collisions with wind turbines is important because the appropriate siting of wind power facilities is one of the most important ways to minimize collisions with birds (Nelson and Curry 1995).

OBJECTIVES

The overall goal of this study was to collect information on the migration characteristics of nocturnal birds (particularly passerines) during the fall migration period. The specific objectives were to: (1) collect baseline information on flight directions, migration passage rates, and flight altitudes of nocturnal passerine migrants at the proposed project area during fall 2003; (2) determine if nocturnal migrants concentrate along the proposed Allegheny Front within the project area; and (3) determine if there is variation in the amount or altitude of migrants at up to three locations along the ridge at a 1,500 m radius scale.

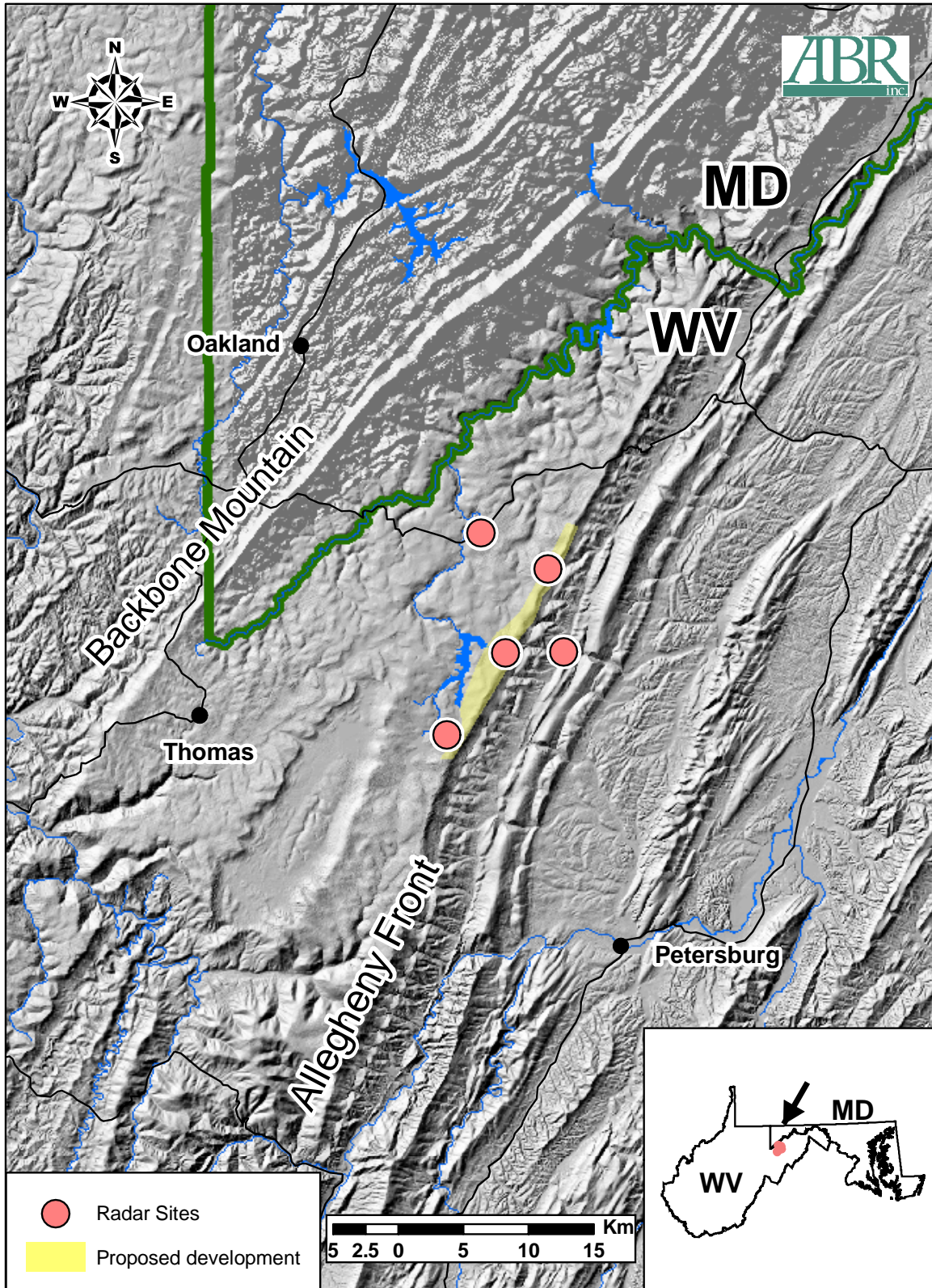

Figure 1. Map of the proposed Mt. Storm wind power development in West Virginia.

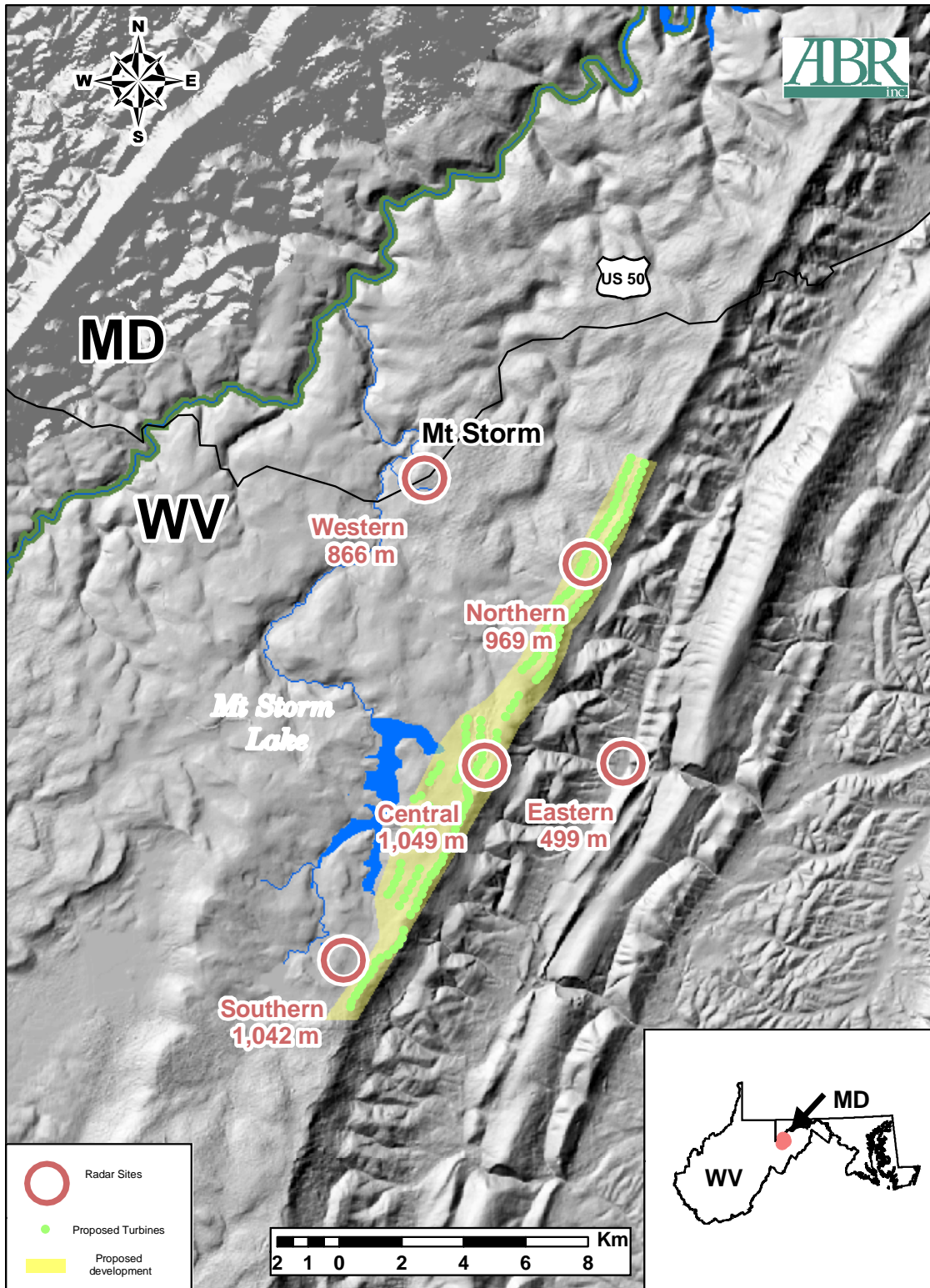

Figure 2. Map of the radar sampling sites and proposed wind turbines at the proposed Mt. Storm wind power development, West Virginia.

STUDY AREA

The proposed Mt. Storm Wind Power Development is located in Grant County, in northeast West Virginia. Grant County lies within the Allegheny Mountains physiographic region and is along the western edge of the Ridge and Valley physiographic province (Buckelew and Hall 1994). The Allegheny Mountains are characterized by steep to rolling mountains, ridges, hills and high plateaus (Fig. 1). The proposed development is located on the primary ridgeline of the Allegheny Mountains known as the Allegheny Front, located ~0.8–1.6 km east of Mt. Storm Lake, ~6 km east of Mount Storm, and ~5 km west of Scherr. West Virginia Highway 42/93, which runs between Bismarck and Scherr, bisects the site at approximately the midpoint. Elevation of the site ranges from ~800 m to ~1,150 m. The proposed project site is private land used for coal mining, commercial logging, and recreation (hunting). Three of our radar sites were located within the proposed wind power development area authorized by the West Virginia Public Service Commission permit: (1) central site (UTM 17S 653448E 4339695N; elevation 1049 m); (2) northern site (UTM 17S 656687E 4346150N; elevation 969 m); and (3) southern site (UTM 17S 648919E 4333424N; elevation 1042 m). Our western radar site (UTM 17S 651519E 4348906N; elevation 861 m) was slightly northwest of the project area, but its location was dictated by the lack of a suitable radar site along the western edge of the proposed project area. Our eastern radar site (UTM 17S 657890E 4339759N; elevation 499 m) was located in the valley adjacent to and east of the Allegheny Front escarpment (Fig. 2).

Historically, the Allegheny Mountains were a hardwood and spruce forest (Buckelew and Hall 1994). The hardwood forest type consists primarily of oaks (*Quercus* spp.), maples (*Acer* spp.), hickories (*Carya* spp.), black cherry (*Prunus serotina*), black and yellow birch (*Betula lanta* and *B. alleghaniensis*), and beech (*Fagus grandifolia*) trees (Canterbury 2002). The conifer types consist of red spruce (*Picea rubens*), hemlock (*Tsuga canadensis*), and a variety of pines (*Pinus* spp.), (including red [*P. resinosa*], pitch [*P. rigida*], and Virginia [*P. virginiana*]), that are used for reclamation of abandoned surface mines

(Canterbury 2002). Much of the site has been strip mined for coal and consists of reclaimed areas. The deciduous forest vegetation type on the proposed project site has been logged both recently and historically and shows signs of severe ice and wind damage from recent winters. There are several private cabins scattered around the site, and much of the area around Mt. Storm Lake and Highway 42/93 is developed with private residences and scattered businesses. A large (1,600 MW) coal-fired power plant is located at Mt. Storm Lake.

METHODS

STUDY DESIGN

Between 3 September and 17 October 2003, we conducted 45 nights of radar observations of nocturnal bird migration to overlap with the peak diurnal migratory periods of eastern U.S. passerines along the Allegheny Front (Hall and Bell 1981). Our study design entailed using one radar laboratory at the central site and using a second radar lab to move between two secondary sites (i.e., northern, southern, eastern, or western sites) sampled each night. Each night, we conducted ~6 h or of radar observations at the central site. The central site was located centrally in the proposed project area (Fig. 2). At the secondary sites, we conducted observations for ~2.5–3 h at a site before moving to a second site for an additional 2.5–3 h of sampling. Observer assignments and starting locations of the second mobile radar lab were varied systematically to minimize bias among sites and observers. Radar surveys occurred between 2030 h and 0230 h. This sampling design provided coverage of the peak period of nocturnal migration for passerines within a night (Lowery 1951, Gauthreaux 1971, Alerstam 1990, Kerlinger 1995).

RADAR EQUIPMENT

Our mobile laboratories consisted of a marine radar mounted on the roof of a van or pickup that functioned as both a surveillance and vertical radar. In the horizontal position (i.e., in surveillance mode), the radar scanned the surrounding area around the lab, and we manually recorded information on flight direction, flight behavior, passage rates, and groundspeeds of birds into a

laptop computer. When the antenna was placed in the vertical position, we measured flight altitudes of targets with an index line on the monitor and recorded this data manually into our laptop computer. A description of a similar radar laboratory can be found in Gauthreaux (1985a, 1985b) and Cooper et al. (1991), and a similar vertical radar configuration was described by Harmata et al. (1999, 2003).

The radar (Furuno Model FR-1510 MKIII; Furuno Electric Company, Nishinomiya, Japan) is a standard marine radar transmitting at 9.410 GHz (i.e., X-band) through a 2-m long slotted waveguide (antenna) with a peak power output of 12 kW. The antenna had a beam width of 1.23° (horizontal) × 25° (vertical) and a sidelobe of ±10–20°. Range accuracy is 1% of the maximal range of the scale in use or 30 m (whichever is greater), bearing accuracy is ±1°, and bearing discrimination is >2.5°.

The radar can be operated at a variety of ranges (i.e., 0.5–133 km) and pulse lengths (i.e., 0.07–1.0 μsec). We used a pulse length of 0.07 μsec while operating at the 1.5-km scale and used a pulse length of 0.50 μsec at the 3.0-km scale. At shorter pulse lengths, echo resolution is improved (giving more accurate information on target identification, location, and distance); whereas, at longer pulse lengths, echo detection is improved (increasing the probability of detecting a target). (An echo is a picture of a target on the radar monitor; a target is one or more birds that are flying so closely together that the radar displays them as one echo on the monitor.) This radar has a digital color display with several scientifically useful features, including True North correction for the display screen (to determine flight directions), color-coded echoes (to differentiate the strength of return signals), and on-screen plotting of a sequence of echoes (to depict flight paths). Because targets plot every sweep of the antenna (i.e., 2.5 sec) and because ground speed is directly proportional to the distance between consecutive echoes, we were able to measure ground speeds of plotted targets with a hand-held scale.

Whenever energy is reflected from the ground, surrounding vegetation, and other objects that surround the radar unit, a ground-clutter echo appears on the display screen. Because ground-clutter echoes can obscure bird targets, we

minimized their occurrence by elevating the forward edge of the antenna by ~15° and by parking the radar lab in locations that were surrounded fairly closely by low trees or low hills, where possible. These objects act as a radar fence that shields the radar from low-lying objects farther away from the lab and that produces only a small amount of ground clutter in the center of the display screen. For further discussion of radar fences, see Eastwood (1967), Williams et al. (1972), Skolnik (1980), and Cooper et al. (1991).

Maximal distances of detection of birds by the surveillance radar depends on radar settings (e.g., gain and pulse length), body size of the bird, flock size, flight profile, proximity of birds in flocks, atmospheric conditions, and, to some extent, the amount and location of ground clutter. Flocks of waterfowl routinely are detectable out to 5–6 km, individual hawks usually are detectable to 2–3 km, and single, small passerines are routinely detected out to ~1.5 km (Cooper et al. 1991; Cooper and Mabee, unpubl. data).

DATA COLLECTION

TARGET IDENTIFICATION

The species composition and size of a flock of birds observed on the radar usually was unknown. Therefore, the term “target,” rather than “flock” or “individual,” is used to describe animals detected by the radar. Based on the study period and location, we assumed that the vast majority of targets we observed were passerines, which generally do not migrate as tight flocks (Lowery 1951, Kerlinger 1995); thus we assumed that targets represented single individuals. Differentiating the various target types encountered (e.g., birds, bats, insects) is central to any radar study, especially with X-band radars that can detect small flying animals. Because bat flight speeds overlap with flight speeds of passerines (i.e., are >6 m/s; Tuttle 1988, Larkin 1991, Bruderer and Boldt 2001, Kunz and Fenton 2003; Cooper and Day, unpubl. data), it was not possible to separate bird targets from bat targets based solely on flight speeds. We were able to exclude foraging bats based on their erratic flight patterns; however, it is likely that migratory bats or any bat not exhibiting erratic flight patterns were included in our data.

Of primary importance, however, is eliminating insect targets. We used a combination of techniques to reduce insect contamination in the data and omitted either individual sampling sessions or whole nights when insects severely contaminated the data. We reduced insect contamination by (1) shifting sampling times to later evening hours, when insect activity typically decreased, (2) omitting targets with poor reflectivity (e.g., targets that plotted erratically or inconsistently in locations with good radar coverage), (3) not counting “insect-like” targets (e.g., targets the size of grain speckles or small, slow targets that only appear within 500 m of the lab), (4) editing data prior to analyses by omitting surveillance-radar targets with corrected airspeeds <6 m/s (<13.4 mi/h; following Diehl et al. 2003), and (5) excluding all vertical data collected during sessions in which corresponding surveillance data indicated that >10% of targets had airspeeds <6 m/s.

The 6 m/s airspeed cutoff speed was based on radar studies that have determined that most insects have an airspeed of <6 m/s, whereas the airspeed of birds usually is >6 m/s (Larkin 1991, Bruderer and Boldt 2001). We corrected our observed migration passage-rate estimates by the proportion of targets with airspeeds <6 m/s that were observed in each subsequent 10-min surveillance-radar session.

SAMPLING DESIGN

Each of the six, 60-min nocturnal radar sampling sessions/night consisted of: (1) one 10-min session to collect weather data and adjust the radar to surveillance mode; (2) one 5-min session with the radar in surveillance mode (1.5-km range) for collection of information on migration passage rates; (3) one 10-min session with the radar in surveillance mode (1.5-km range) for collection of information on ground speed, flight direction (°), tangential range (minimal perpendicular distance to the radar laboratory), transect crossed (the four cardinal directions—north, south, east, and west), species (if known), number of individuals (if known), flight behavior (approached and crossed ridge; approached but did not cross ridge; approached, turned but still crossed ridge; did not approach ridge; unknown), and location (west of ridge, over ridge, east of ridge); (4) one 10-min session to adjust the radar to vertical mode; (5) one 10-min

session with the radar in vertical mode (1.5-km range) to collect fine-scale information on flight altitudes <1.5 km agl; and (6) one 5-min session with the radar in vertical mode (3.0-km range) to collect coarse-scale information on flight altitudes ≤3000 m agl. “Coarse-scale” refers to the fact that it is more difficult to differentiate individual targets or to determine exact flight altitudes (especially if they are flying ≤100 m agl) because of the poorer resolution on the 3-km range than at the 1.5-km range. The vertical radar was oriented so that it collected data along a southeast–northwest transect that was approximately perpendicular to the Allegheny Front ridgeline.

Other sets of data were collected opportunistically throughout the study period to supplement the principal sampling effort. For example, during 21 nights between 16 September and 17 October, we plotted target flight paths at the central site onto acetate overlays during 5-min surveillance-radar sessions (generally during the 10-min session for collecting weather data and adjusting the radar). Flight paths then were digitized and plotted as polylines (lines consisting of multiple segments) in ArcView (v. 3.2) for supplemental behavioral analysis. Following completion of radar sampling sessions on 10 nights with high passage rates, we also videotaped the monitor with the radar in 1.5-km-range vertical mode throughout the remaining hours of the night. The videotapes later were analyzed following similar protocols as real-time data collection in the field (except that altitudes were recorded categorically in 200 m layers), to assess temporal variation in flight altitudes across all hours of the night.

Visual surveys (using a 2,000,000 Cp spotlight) and auditory surveys were also conducted opportunistically to help the radar operator assess real-time insect conditions and document the presence of birds and bats. Insects were recorded on most nights, birds were observed on 20–30% of the nights sampled/site using spotlights, and were observed on 20–50% of nights sampled/site using moon watch surveys. Bats were observed infrequently on 6–10% of the nights sampled/site using spotlights and on 10–20% of nights sampled/site using moon watch surveys. This information was valuable to radar operators to identify potential targets in low altitude layers.

Weather data collected at the beginning of each hour consisted of the following: wind speed (collected with a “OMNI” anemometer in 5-mi/h [2.2-m/s] categories); wind direction (to the nearest 45°); cloud cover (to the nearest 5%); ceiling height (in m agl; 1–50, 51–100, 100–150, 151–500, 501–1,000, 1,001–2,500, 2,501–5,000, >5,000); minimal visibility in a cardinal direction (in m; 0–50, 51–100, 101–500, 501–1,000, 1,001–2,500, 2,501–5,000, >5,000); precipitation (no precipitation, fog, drizzle, light rain, heavy rain, snow flurries, light snowfall, heavy snowfall, sleet, hail); and air temperature (measured with a thermometer to the nearest 1°C). We could not collect radar data during rain because the electronic filtering required to remove the echoes of the precipitation from the display screen also removed the targets of interest. We also obtained weather data (wind speed and direction) from two 50-m-high meteorological towers located near our central and northern sites.

DATA ANALYSES

TREATMENT OF RADAR DATA

All radar data were entered into an Excel database. Data files were checked visually for errors after each night and then checked again both visually and electronically for irregularities at the end of the field season, prior to data analyses. All analyses were conducted with SPSS statistical software (SPSS 2002). For quality assurance, we cross-checked results of the SPSS analyses with hand-tabulations of small data subsets, whenever possible.

Airspeeds (i.e., groundspeed corrected for wind speed and direction) of surveillance radar targets were computed with the formula:

$$V_a = \sqrt{V_g^2 + V_w^2 - 2V_g V_w \cos\theta}$$

where V_a = airspeed, V_g = target groundspeed (as determined from the radar flight track), V_w = wind velocity, and θ is the difference between the observed flight direction and the direction of the wind vector.

Targets with corrected airspeeds <6 m/s (4%) were deleted from all analyses. We analyzed flight-direction data following procedures for circular statistics (Zar 1999) with Oriana software

version 2.0 (Kovach 2003). Migration passage rates are reported as the mean \pm 1 standard error (SE) number of targets passing along 1 km of migratory front/h (targets/km/h \pm 1 SE). Passage rates were corrected at three sites for ground clutter and radar shadows. At the eastern site, targets were only counted west of the radar site, and passage rates were adjusted accordingly. Passage rates were also corrected at the northern and southern sites because of differences in detectability associated with the flight direction of targets. At the northern site, radar coverage varied from 90–100% of the screen width, with lowest detectability for targets flying along the 30°/210° axis. At the southern site, coverage decreased to a minimum of 75% of the screen for targets flying along the 45°/225° axis. To correct for this situation, we applied a flight-direction-specific weighting factor to all targets observed during each 10-minute surveillance session. An average of these weighting factors was then calculated for each session and used as a correction factor for the associated passage rate estimate. Radar data were not corrected for differences in detectability with distance from the radar unit.

All flight-altitude data are presented in m agl (above ground level) relative to a horizontal plane passing through the radar-sampling site. All statistical summaries of flight-altitude data were made with the 1.5-km-range data because this scale provided adequate target resolution; in contrast, the 3.0-km range did not provide adequate target resolution at low altitudes. Actual mean altitudes typically will be higher than reported because some targets were flying >1.5 km. Targets below 100 m were weighted for site-specific differences associated with ground clutter. For analysis of within-night temporal variation in flight altitudes, 10 nights of videotape results were combined with data obtained earlier each evening. To correspond with the structure of the video data, the real-time flight altitude data were categorized to obtain counts of targets within 200-m intervals.

For calculations of the daily patterns in migration passage rates and flight altitudes, we assumed that a day began at 0700 h and ended at 0659 h, so that a sampling night was not split between two dates. We used repeated-measures ANOVA, with the Greenhouse-Geisser epsilon adjustment for degrees of freedom, to compare

passage rates and flight altitudes among hours of the night for nights with complete sampling (i.e., all six sessions). Factors that decreased our sample size of the various summaries and analyses included insect contamination and inclement weather (rain). Sample sizes therefore sometimes varied among the different summaries and analyses. The level of significance (α) for all tests was set at 0.05.

Flight behaviors were investigated by analyzing target behaviors recorded directly during surveillance radar sessions and flight paths plotted on acetate overlays. Targets were considered to have reacted to the ridge if they exhibited a change in flight direction of $\geq 10^\circ$ while crossing the ridge. Polylines representing plotted flight paths were analyzed in ArcView 3.2 by comparing the orientation of segments over the ridge (500-m width) with that of corresponding segments east and/or west of the ridge. We also compared mean flight directions of all plotted targets east and west of the ridge using the Mardia–Watson–Wheeler (Uniform Scores) test for paired comparisons of all sessions that had a minimum of eight polylines on each side of the ridge.

SITE COMPARISONS

We provided comparisons between each of the four additional secondary sites and the central site by using paired data collected concurrently (i.e., central:northern, central:southern, central:eastern, central:western). Because of the differences in elevation, our comparisons between the central site (at the top of the ridge) and the eastern site (550 m lower than the ridgetop, at the bottom of a valley) are valid only for comparing the same relative sampling space above ground level (agl). We used nonparametric tests in all paired comparisons because our data did not meet assumptions of normality. We used the Mardia–Watson–Wheeler (Uniform Scores) test for paired comparisons with flight directions and Wilcoxon paired-sample tests for comparisons of passage rates and flight altitudes. Flight-direction analyses were conducted with Oriana software v.2.0 (Kovach 2003), and the remaining analyses were conducted with SPSS software (SPSS 2002).

RIDGE-WIDE PASSAGE RATES

We generated two ridge-wide estimates of migration passage rates across the length of the

proposed development area (using the northern, central, and southern radar sites) to 1) allow comparisons with other proposed development areas, and 2) allow computation of avian risk (Appendix 1). To derive the first metric, we first applied results of our paired comparisons to our full-season passage rate estimate from the central site to calculate seasonal estimates of passage rates at the northern and southern sites. A ridge-wide estimate was then derived as the average of the seasonal estimates for all three ridge sites. To derive the second metric, we again applied results from concurrent sessions to our full-season estimate from the central site to determine seasonal passage rates in the zone within the turbine area. We multiplied the percentage of targets flying < 125 m agl (from 1.5 km vertical sampling) to passage rate data (targets/km/h) on a nightly basis and derived a mean rate for each site. The passage rates of the north and south sites, relative to concurrent rates at the central site, were then applied to the full-season rate (at the central site) to calculate full-season estimates at each of the two secondary ridge sites. We then took a mean of the three sites and adjusted for the sample area (125,000 m²) to determine a ridge-wide passage rate within the turbine area (targets/h/m²).

RESULTS

CENTRAL SITE

FLIGHT DIRECTION

At night, most radar targets were traveling in seasonally appropriate directions for fall migration (i.e., southerly), with a mean flight direction of $184 \pm 1^\circ$ for the entire fall season ($n = 4,260$ targets; Fig. 3). Most (82%) of the nocturnal targets were traveling in a southerly direction, with half (51%) of the flight directions between SE (135°) and SW (225°).

FLIGHT BEHAVIOR

Of 4,252 targets observed, the behaviors of over half (59.2%) could not be determined. Unknown behaviors were primarily associated with targets whose extrapolated flight paths transected the ridge but did not plot long enough to determine if they actually crossed the ridge (Table 1). Of those targets with known behaviors ($n = 1,733$), 5.3% (91) of the targets approached the

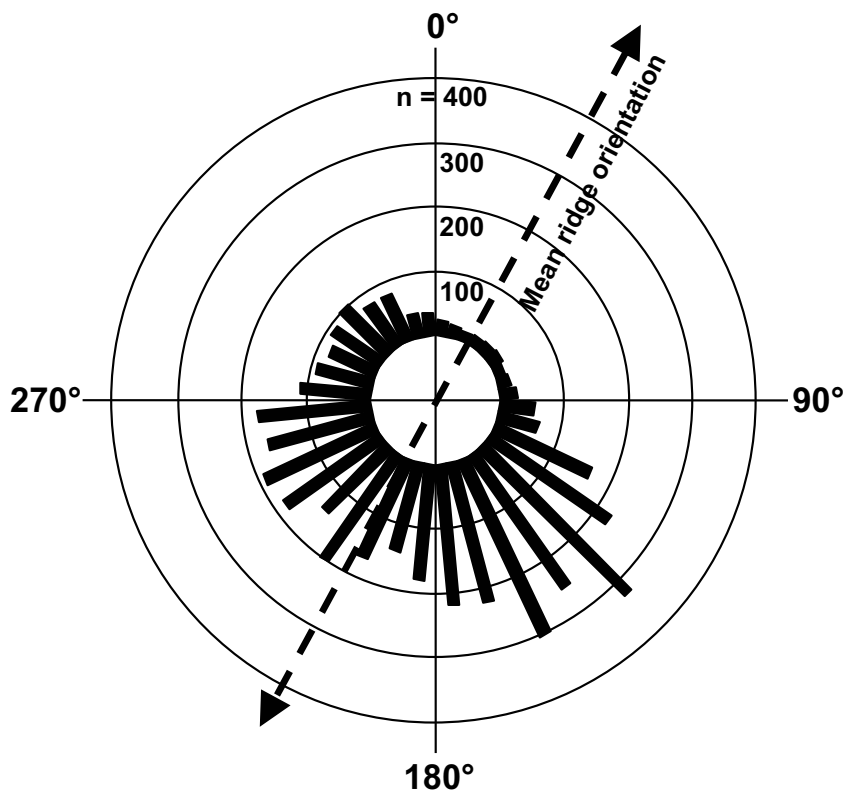

Figure 3. Flight directions of radar targets at the Mt. Storm central site, West Virginia, during fall 2003.

Table 1. Flight behavior of radar targets observed on surveillance radar at the Mt. Storm reference site, WV, during fall 2003 (n = number of radar targets).

Flight behavior	Percent of radar targets	n
Approached and crossed ridge	20.2	861
Approached, turned $>10^\circ$, and crossed ridge	2.0	85
Approached and did not cross ridge (flew parallel to or away from ridge)	0.1	6
Did not approach ridge	18.4	781
Unknown	59.2	2,519

ridge and turned $>10^\circ$ ($n = 85$) or approached the ridge and did not cross the ridge ($n = 6$). Of those targets known to cross the ridge ($n = 946$), 9% (85) altered their flight direction $>10^\circ$ when crossing the ridge.

We also examined flight paths of targets plotted on acetate overlays. Plotted flight paths of 261 targets crossed the ridge from either the east or west, and 13.4% of these targets shifted their flight direction at least 10° . A subset of these same targets shifted their flight direction at least 15° (8%), 20° (5.4%), or 25° (3.1%). Overall, mean flight directions of targets located west of the ridge did not differ from those of targets east of the ridge (mean difference = 10° , $W = 1.556$, $P = 0.46$, $n = 19$ sessions).

PASSAGE RATES

The mean nocturnal passage rate for the entire fall season at the central site was 241 ± 33 targets/km/h ($n = 40$ nights). Mean nightly passage rates were highly variable during the study, with rates varying by two orders of magnitude (8–852 targets/km/h; Fig. 4). Passage rates also varied significantly among hours of the night ($F_{3,5, 92} = 2.751$; $P = 0.039$; $n = 27$ nights; Fig. 5), with

lowest rates typically during the earliest session of the night.

FLIGHT ALTITUDES

The mean nocturnal flight altitude observed on vertical radar (1.5 km range) for the entire fall season at the central site was 410 ± 2 m agl ($n = 17,543$ targets; median = 350 m agl). Mean flight altitudes were highly variable among nights and ranged from 214 to 769 m agl (Fig. 6). Mean flight altitudes generally peaked early in the evening and then declined ($F_{3,3, 56.8} = 4.01$, $P = 0.009$, $n = 18$ nights; Fig. 7). Mean altitudes late in the evening (0200 h; 387 m agl), were lower than mean altitudes earlier in the evening (2200 h; 496 m agl). Further examination of the temporal patterns in passage rates (combining real-time data from 2100–0300 h and video data from 0300–0700 h) indicated that the percentage of targets flying at low altitudes (i.e., 0–200 m agl) appeared to exhibit a bimodal distribution, with one peak occurring at ~ 2300 h and a second peak occurring shortly before sunrise (~ 0500 – 0700 ; Fig. 8).

At the central site, the overall distribution of flight altitude targets in 100 m categories varied from a high of 15.6% in the 100–200-m agl

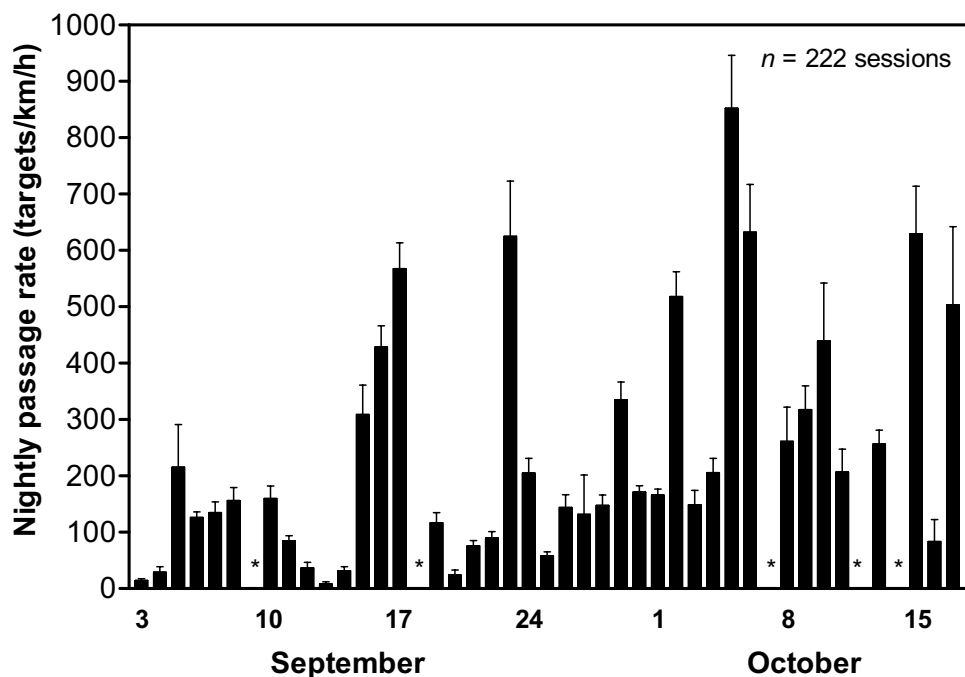

Figure 4. Mean nightly passage rates (targets/km/h \pm 1SE) at the Mt. Storm central site, West Virginia, during fall 2003. Asterisks denote nights not sampled.

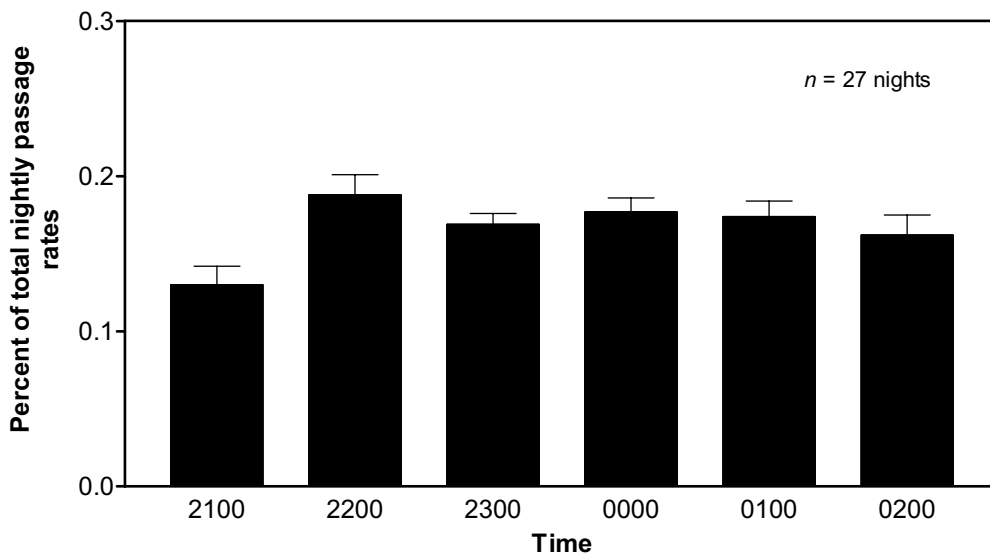

Figure 5. Percent of total nightly passage rates (\pm 1SE) by hour of the night at the Mt. Storm central site, West Virginia, during fall 2003.

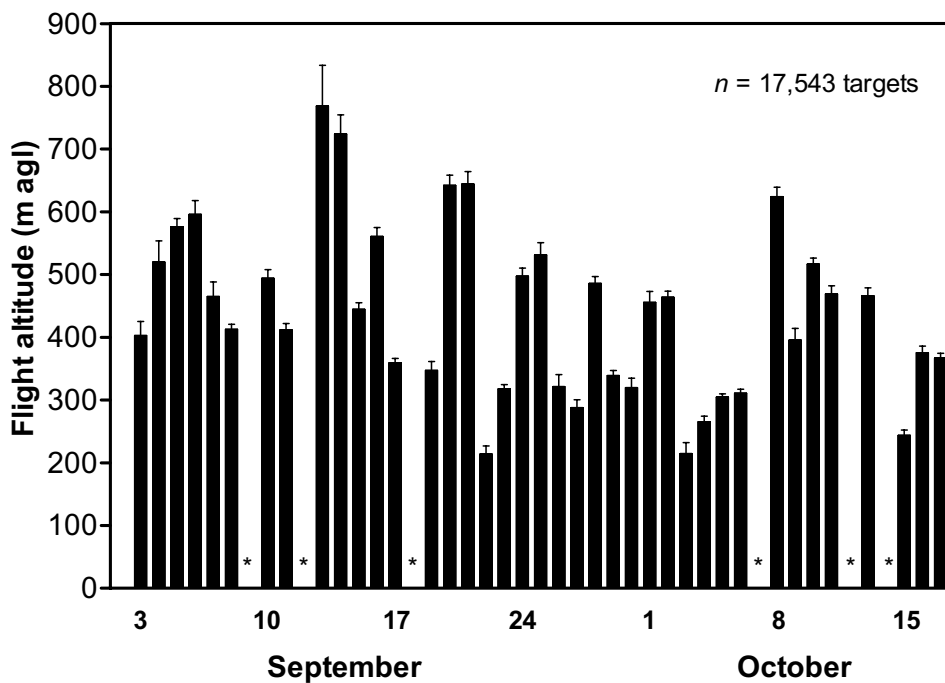

Figure 6. Mean nightly flight altitudes (m agl \pm 1SE) at the Mt. Storm central site, West Virginia, during fall 2003. Asterisks denote nights not sampled.

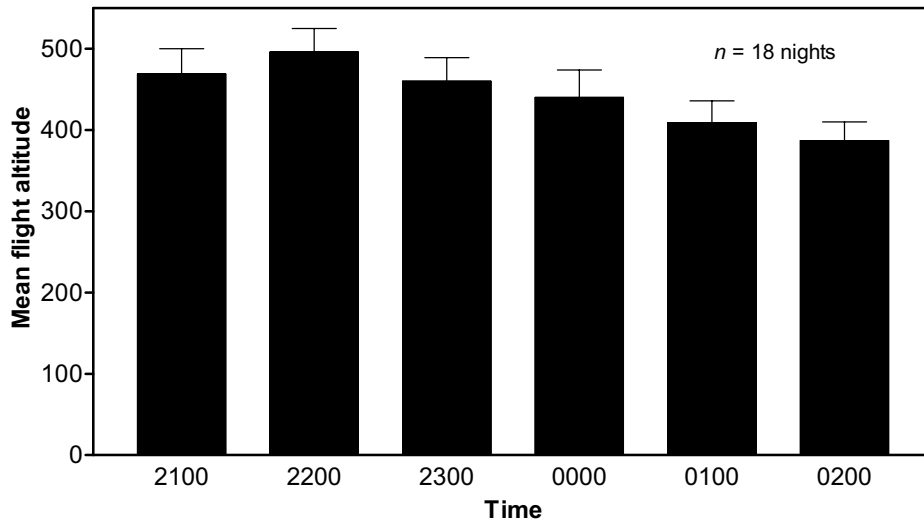

Figure 7. Mean flight altitude (m agl \pm 1SE) by hour of the night at the Mt. Storm central site, West Virginia, during fall 2003.

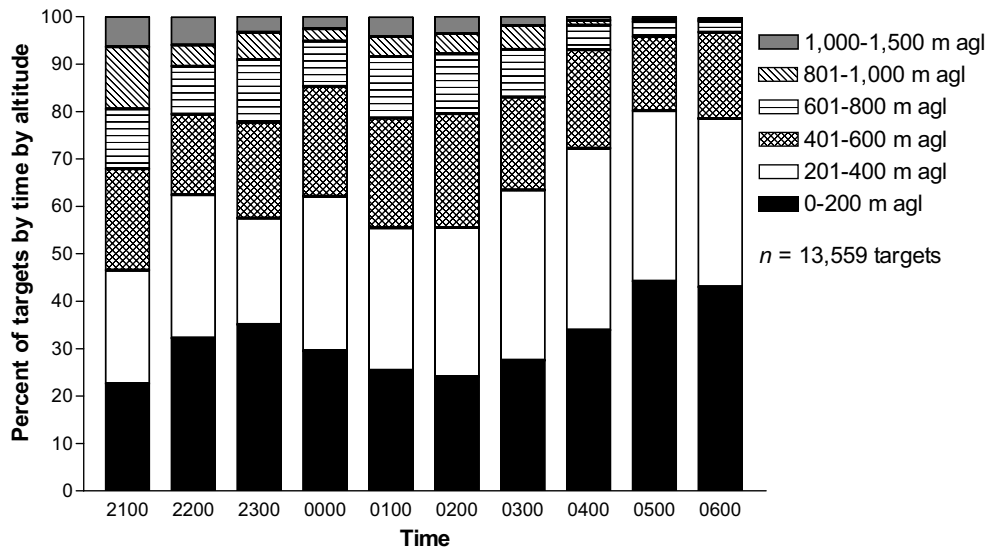

Figure 8. Percent of targets by hour of the night and altitude at the Mt. Storm central site, West Virginia, during fall 2003.

interval to a low of 0.1% in the 1,401–1,500-m agl interval (Table 2). The maximal height of the proposed wind turbines (125 m) contained 16% of all targets. Our 3.0-km vertical radar sampling indicated that 85% of the nights ($n = 40$) had at least one target flying from 1,500–3,000 m agl. For nights when targets could be effectively sampled to 3,000 m ($n = 32$), 8.2% of targets were flying >1,500 m agl, with a maximal recorded altitude of 2,880 m. The actual mean flight altitude of targets at the central site we reported for the 1.5-km range data, therefore, is higher than 410 m agl because some birds were migrating in the airspace above 1,500 m agl.

FLIGHT SPEEDS

The mean airspeed of radar targets recorded for the entire fall season was 12.5 ± 0.1 m/sec ($n = 4,260$ targets). Nightly mean air speeds varied during the fall season, ranging from 8 to 15 m/sec (Fig. 9).

Table 2. Nocturnal flight altitudes of radar targets (% of targets) detected at the 1.5-km range at the Mt. Storm reference site, WV, during fall 2003 ($n = 17,543$ targets).

Flight altitude (m agl)	Percent of radar targets
0–100	12.7
101–200	15.6
201–300	14.8
301–400	13.3
401–500	11.9
501–600	9.2
601–700	6.9
701–800	5.1
801–900	3.5
901–1,000	2.9
1,001–1,100	1.7
1,101–1,200	1.2
1,201–1,300	0.7
1,301–1,400	0.3
1,401–1,500	0.1

SITE COMPARISONS

Because of our study design (see methods), analyses of site-specific variation in migration patterns are presented as paired comparisons for each of the four secondary sites, with pairs consisting of the central and one of the additional sites. We provide these paired comparisons on a daily basis for flight directions (Appendix 2), passage rates (Appendix 3), and flight altitudes (Appendix 4). These paired comparisons use concurrently collected data, which is important, given the large variation in metrics within and among nights. Note that interpretation of comparisons between the central site and eastern site requires special caution because differences in site elevations only allow comparisons to be made in the same air layer above ground level.

FLIGHT DIRECTIONS

Mean flight directions at the central site were not significantly different from those of corresponding sessions at the northern, southern, and western sites (all comparisons with $W < 4.00$, $P > 0.200$, $n = 18$ –22). In contrast, mean flight directions differed significantly between the central and eastern sites ($W = 19.25$, $P < 0.001$, $n = 17$; Table 3).

MEAN PASSAGE RATES

Passage rates were not significantly different from the central and northern sites ($Z = -1.49$, $P = 0.136$, $n = 17$). In contrast, they were significantly different between the central site and the southern, eastern, and western sites (all comparisons with $Z < -1.96$, $P \leq 0.05$, $n = 18$ –21; Table 3).

MEAN FLIGHT ALTITUDES

Mean flight altitudes at the central site were not significantly different from those of corresponding sessions at the northern, southern, and western sites ($Z > -0.68$, $P > 0.49$, $n = 15$ –21). In contrast, they were significantly different from those at the eastern site ($Z = -2.02$, $P = 0.04$, $n = 16$; Table 3).

RIDGE-WIDE PASSAGE RATES

Based on the results of the paired comparisons, we estimated that the mean nocturnal passage rates for the entire fall season at the

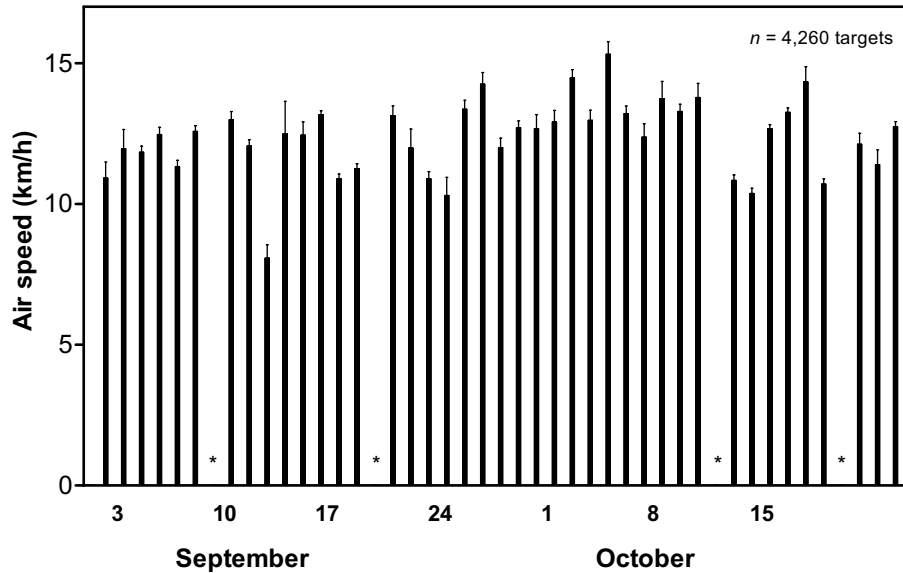

Figure 9. Mean nightly air speed (km/h \pm 1 SE) at the Mt. Storm central site, West Virginia, during fall 2003. Asterisks denote nights not sampled.

northern and southern ridge sites were respectively 186 and 169 targets/km/h, corresponding with the 241 targets/km/h reported from the central site. Averaging rates at these three sites, the estimated mean passage rate for the entire project development was therefore 199 targets/km/h. Estimated passage rates below 125 m were also lower at the northern and southern sites (respectively 30.8 and 35.7 targets/km/h). Combined with the calculated rate at the central site (42.5 targets/km/h below 125m), we estimated a ridge-wide mean passage rate of 36.3 targets/km/h below 125 m, or 2.91×10^{-4} targets/m²/h within the zone of potential risk.

DISCUSSION

MIGRATION CHARACTERISTICS

Predictions of the effects of wind power development on migratory birds are hampered by a lack of knowledge of patterns of nocturnal migration. We addressed this paucity of data by documenting some of the key migration characteristics (flight directions, timing of migration, passage rates, flight altitudes, flight speeds) that can be used both to assess the risk of collision with wind turbines and to describe

general properties of nocturnal bird migration at the proposed Mt. Storm Wind Power Development. These results are specific to the fall period of passerine migration, as spring migration may differ in terms of both geographical patterns of movements (e.g., Blackpoll Warblers: Hunt and Eliason 1999) and migratory flight characteristics (Blokpoel and Burton 1975, Bellrose 1976, Cooper and Ritchie 1995, Harmata et al. 2000).

FLIGHT DIRECTIONS

Mean flight directions of radar targets were typically in the expected direction during fall migration (i.e., southerly), although directions were highly variable from day to day. One paired comparison (central:eastern) suggested that targets traveling in the valley at the eastern site generally flew along the main axis of the valley (i.e., 193°), whereas targets along the ridge at the central site were generally traveling south (i.e., 178°). This comparison is confounded, however, by a 550-m difference in elevation between the sites. We can only describe flight directions of targets sampled in a comparable area above ground level. Consideration of this confounding effect at the eastern site also applies to all additional comparisons presented below.

Table 3. A comparison of flight directions, overall passage rates, and flight altitudes of radar targets at the central and other sites near Mt. Storm, WV, during fall 2003 (n = number of nights surveyed). Test statistics are for Wilcoxon paired-sample test (Z) and Mardia-Watson-Wheeler (Uniform Scores) test (W).

	Site	n	Comparison site		Central site		Test results		
			Mean	SE ¹	Mean	SE ¹	Z	W	P
Mean flight direction (degrees)	Northern	18	197°	53°	177°	54°	1.40	0.496	
	Southern	22	191°	55°	207°	62°	1.06	0.588	
	Eastern	19	193°	25°	178°	67°	19.25	<0.001	
	Western	17	219°	44°	191°	65°	3.23	0.199	
Mean passage rate (targets/km/hr)	Northern	17	225	57	292	66	-1.49	0.136	
	Southern	21	168	31	239	37	-1.96	0.050	
	Eastern	21	54	10	220	52	-3.77	<0.001	
	Western	20	127	22	230	47	-2.70	0.007	
Mean flight altitude (m agl)	Northern	16	448	29	439	37	-0.52	0.605	
	Southern	21	447	31	467	33	-0.57	0.566	
	Eastern	16	509	23	427	41	-2.02	0.044	
	Western	17	436	20	472	30	-0.97	0.332	

¹ Variations in mean flight directions are presented as angular deviations.

TIMING OF MIGRATION

The timing of nocturnal migration is important at several temporal scales—within nights, within seasons, and seasonally within years. Understanding the timing of migration at all scales allows determination of patterns of peak nocturnal migration that are critical to development of predictive models of avian risk and that could be used to develop mitigating measures that reduce migrant fatalities. In our study, passage rates increased ~1–2 h after sunset, leveled off, and then decreased slightly later in the evening (i.e., ~0145–0245). Several studies have found a pattern similar to this, in which the intensity of nocturnal migration begins to increase ~30–60 min after sunset, peaks around midnight, and declines steadily thereafter until dawn (Lowery 1951, Gauthreaux 1971, Kerlinger 1995).

Nocturnal migration is often a pulsed phenomenon seasonally as well (Alerstam 1990; B. A. Cooper and R. H. Day, ABR, Inc., unpubl. data). In this study, relatively large movements of birds (> 400 targets/km/h) occurred on 22.5% of the nights studied (16, 17 and 23 September, and 2, 5, 6, 10, 15, and 17 October). The high daily variation (two orders of magnitude) in migration passage rates during the fall illustrate the importance of continuous sampling throughout the entire fall migration period to identify these few and scattered, but important, peak migration nights. These peaks may correspond with factors that are predictable only within a short time span (such as passage of weather fronts); however, multi-year studies can provide resolution of general patterns of peak movements within the migratory season, narrowing the range of days in which peaks are likely to occur.

PASSAGE RATES

Passage rates are an index of the number of migrants flying past a location and can be used to assess the relative importance of sites being considered for wind power development. In this study, mean passage rates were similar in paired comparisons between the central and northern sites, but were significantly lower at the southern, western, and eastern sites relative to the central site. These differences suggest consistent spatial patterns in migration passage rates at a local scale. This contrasts with the current paradigm of

broad-front passerine migration, which has generally implied a lack of distinct flight pathways, but rather uniform densities of migrants across regional migratory fronts of up to several hundred kilometers in width (Hutto 2000, Berthold 1993).

Possible explanations for this pattern include (1) variation in migration patterns across landscape features (e.g., birds responding to local topography [Williams et al. 2001] or phenomena associated with ridgelines [i.e., wind]) and (2) site-specific differences in the altitudinal zone that was sampled. Evidence for variation in migration patterns across landscape features was not found and is discussed more fully in subsequent sections. Site differences in the altitudinal zone that was sampled are plausible (the central site was 550 m higher than the eastern site, 188 m higher than the western site, 80 m higher than the northern site, and 7 m higher than the southern site); however, we believe these differences in elevation only help explain the observed differences at the eastern site. Mean flight altitudes were similar between the central and western sites (implying a similar distribution of targets in the air space over both sites), and therefore altitudinal differences do not explain the higher passage rates at the central site.

Putting our results from this study in context is difficult, as there are few published data on fall nocturnal passage rates available for other locations in the Eastern US. On a broad scale, however, our study area appeared to have relatively high rates of migration compared to other locations, where we have conducted studies using similar equipment and methods. For example, the mean fall nocturnal passage rate in this study for the central station was 241 targets/km/h, and the overall ridge-wide mean (based on results from three radar sites) was 199 targets/km/h; compared with 17–28 targets/km/h at the Stateline and Vansycle wind power facilities in eastern Oregon (Mabee and Cooper 2002), 25–100 targets/km/h at four sites in the Midwest (Day and Byrne 1990), and 122–225 targets/km/h at three sites in New York State (Cooper et al. 1995b; Cooper and Mabee 2000). Harmata et al. (1998) did not distinguish between diurnal and nocturnal migration rates in their study near Ennis Lake, Montana but reported a peak migration rate of ~62 targets/km/h within the seasonal range of dates of our study.

We also examined the influence of weather and date on migration passage rates (Appendix 5) and identified the best approximating model containing the variables date, wind direction, and ceiling height. Migration passage rates increased with date (i.e., higher passage rates were observed later in the season), and this pattern was illustrated by our figure examining passage rates by date (Fig. 4)—the highest passage rates occurred in late September and October. Passage rates also increased with tailwinds and eastern or western crosswinds, but decreased with headwinds. This pattern is generally consistent with other studies (Lowery 1951, Gauthreaux 1971; Able 1973, 1974; Blokpoel and Gauthier 1974, Richardson 1990), and wind direction was the strongest variable in our model. Passage rates also decreased with low ceiling heights (i.e., < 500 m agl). Although we are not certain why this latter pattern may have occurred, there are several possible reasons, including (1) birds migrating above the cloud layer (and potentially above the effective sampling range of our radar) and (2) a correlation between low ceiling conditions and unfavorable migratory conditions.

FLIGHT ALTITUDES

Flight altitudes are critical for understanding the vertical distribution of nocturnal migrants and are another important metric used to assess the suitability of a site for wind power development. Relative to other bird groups, passerines migrate at lower flight altitudes; whereas shorebirds and waterfowl tend to migrate at higher altitudes (Kerlinger 1995). Because we know that birds were often flying above 1.5 km in this study (based on our 3.0-km-range sampling), our mean flight altitudes (410 m agl) based on 1.5-km-range data are minima, and the percentages of targets within 100 m agl (and all other categories) are maxima.

Similar to our results, most other studies, using a variety of radar systems and analyses, have indicated that the majority of nocturnal migrants fly below 600 m agl (Bellrose 1971; Gauthreaux 1972, 1978, 1991; Bruderer and Steidinger 1972; Cooper and Ritchie 1995). Kerlinger (1995) summarized radar results from the eastern U.S. and concluded that three-quarters of passerines migrate within this lower range of altitudes (0–600 m agl). The lowest mean flight altitudes of nocturnal

migrants (209 m agl) were reported during fall migration in southwestern Montana by Harmata et al. (2000), with a radar system nearly identical to that used in this study. We also examined the percentage of targets within 125 m agl and found that 16% of birds at central area (13% for all radar sites along the ridge) flew below 125 m at the proposed Mt. Storm site, compared to 3–9% (below 125 m agl) at two sites in the Pacific Northwest that were studied using similar methods (Mabee and Cooper 2002).

In contrast to these results, other researchers have found that peak nocturnal densities extend over a broad altitudinal range up to ~2,000 m (Harper 1958, in Eastwood 1967; Graber and Hassler 1962; Nisbet 1963; Bellrose and Graber 1963; Eastwood and Rider 1965; Bellrose 1967; Blokpoel 1971; Richardson 1971, 1972; Blokpoel and Burton 1975). We suspect that differences between the two groups of studies are largely due to differences in location, species-composition of migrating birds, local topography, radar equipment used, and perhaps weather conditions. It has been suggested that limitations in equipment and sampling methods of some previous radar studies may have been responsible for their overestimation of the altitude of bird migration (Able 1970, Kerlinger and Moore 1989). For example, the radars used by Bellrose and Graber (1963), Blokpoel (1971), and Nisbet (1963) could not detect birds below 450 m, 370 m, and 180 m agl, respectively. In contrast, our vertical radar could detect targets down to ~10 m agl; so we believe that, given the relative paucity of migrants above 1,500 m, the data we collected for this study more accurately reflect actual flight altitudes.

In this study, mean flight altitudes were lower at the end of our nightly sampling period, although the maximal range of differences between hourly means was 70 m. An examination of our pilot data from nights with high migration passage rates ($n = 10$ nights), however, showed that the proportion of targets flying < 200 m agl was greatest at ~0500–0700 (Fig. 8). These patterns may explain why more birds are killed at tall obstacles after midnight than before midnight (Weir 1976) and suggest that, despite decreases in overall passage rates during later hours of the night, actual numbers of low altitude migrants could increase toward dawn. Total nightly passage

rates at lower altitudes, therefore, could differ from those extrapolated from rates obtained for the first six hours of each night's migration.

As with our migration studies elsewhere (Cooper and Ritchie 1995; Cooper et al. 1995a, 1995b; Cooper and Mabee 2000; Mabee and Cooper 2002), we recorded large among-night variation in flight altitudes at the central site. Mean flight altitudes always were above the maximal proposed turbine heights during fall 2003, however, there were five nights when mean flight altitudes fell between 200 and 300 m agl. Weather conditions varied within and between nights, but three of the five nights had precipitation, low clouds (<500 m agl) and variable wind directions and speeds, whereas the remaining two nights had no precipitation, high clouds, and variable wind directions and speeds. Daily variation in flight altitudes probably reflected changes in both species-composition and vertical structure of the atmosphere and weather. Kerlinger and Moore (1989) and Bruderer et al. (1995) have concluded that atmospheric structure is the primary selective force determining the height at which migrants fly. Other locations also exhibit considerable variation among days in the flight altitudes of migrants that were related primarily to changes in the vertical structure of the atmosphere (Gauthreaux 1991). Birds crossing the Gulf of Mexico, for example, appear to fly at altitudes at which favorable winds minimize the energetic cost of migration.

DID MIGRANTS CONCENTRATE ALONG THE ALLEGHENY FRONT?

The Allegheny Front ridgeline is thought to be used as a leading line by some diurnal migrants (Hall and Bell 1981), but its role for nocturnal migrants is unknown. We used a weight of evidence approach to this question and evaluated data on flight directions, flight path behaviors, NEXRAD images, and passage rates. Flight directions of targets among ridge sites were similar, and targets passed over, rather than flew parallel to, the main axis of the ridge. Similarly, targets crossing the Allegheny Front showed little or no deviation in their flight paths when they passed over ridges. Strong correlations between overall flight directions of migrants from NEXRAD weather radar data and our ridge sites

(see Appendix 6) further suggest that migration patterns did not vary with local topography.

In contrast, the variation in passage rates among some of the ridge sites (central:southern) and other sites (central:western), does not corroborate this pattern. These differences in passage rates, however, may not be correlated with landscape features (i.e., they may misrepresent patterns or simply reflect random variation because of our low sample size ($n = 1$) for off-ridge locations), and we consider this result equivocal. The main body of evidence therefore suggests that, at the scale of our observations, nocturnal migrants did not concentrate (or compress their migratory flight path) along the Allegheny Front.

CONCLUSIONS

This study focused on nocturnal migration patterns and flight behaviors during the peak period of fall passerine migration at the proposed Mt. Storm Wind Power Development in West Virginia. The key results of our study were: (1) relatively high mean passage rates (i.e., 199 targets/km/h ridge-wide); (2) approximately 20% of nights had passage rates much higher than the mean rate for the fall season; (3) variation in passage rates among some ridge sites (central:southern) and between ridge and off-ridge sites (central:western); (4) the weight of evidence suggesting that migrants did not concentrate along the Allegheny Front in fall 2003; (5) similar mean flight altitudes among sites (excluding valley); and (6) 13% of targets < 125 m agl ridge-wide, which is higher than the small number of comparable studies.

LITERATURE CITED

- Able, K. P. 1970. A radar study of the altitude of nocturnal passerine migration. *Bird-Banding* 41: 282–290.
- Able, K. P. 1973. The role of weather variables and flight direction in determining the magnitude of nocturnal migration. *Ecology* 54: 1031–1041.
- Able, K. P. 1974. Environmental influences on the orientation of free-flying nocturnal bird migrants. *Animal Behaviour* 22: 224–238.

- Alerstam, T. 1990. Bird migration. Cambridge University Press, Cambridge, United Kingdom. 420 pp.
- Allen, G. M. 1939. Bats. Dover Publications, New York, NY. 358 pp.
- Altringham, J. D. 1996. Bats: biology and behaviour. Oxford University Press, Inc., New York, NY. 262 pp.
- Anderson, R., M. Morrison, K. Sinclair, and D. Strickland. 1999. Studying wind energy/bird interactions: a guidance document. Metrics and methods for determine or monitoring potential impacts on birds at existing and proposed wind energy sites. National Wind Coordinating Committee, Washington, DC. 87 pp.
- Avery, M. L., P. F. Springer, and N. S. Dailey. 1980. Avian mortality at manmade structures: an annotated bibliography (revised). U.S. Fish and Wildlife Service, Biological Services Program, Report No. FWS/OBS-80/54. 152 pp.
- Bellrose, F. C. 1967. Radar in orientation research. Proceedings XIV International Ornithological Congress. pp. 281–309.
- Bellrose, F. C. 1971. The distribution of nocturnal migration in the air space. *Auk* 88:397–424.
- Bellrose, F. C. 1976. Ducks, geese, and swans of North America. 2nd ed. Stackpole Books, Harrisburg, PA. 540 pp.
- Bellrose, F. C., and R. R. Graber. 1963. A radar study of flight directions of nocturnal migrants. Proceedings XIII International Ornithological Congress. pp. 362–389.
- Berthold, P. 1993. Bird migration: a general survey. Oxford University Press, New York, NY. 266 pp.
- Blokpoel, H. 1971. The M33C track radar (3-cm) as a tool to study height and density of bird migration. Canadian Wildlife Service Report Series 14: 77–94.
- Blokpoel, H., and J. Burton. 1975. Weather and the height of nocturnal migration in east-central Alberta: a radar study. *Bird-Banding* 46: 311–328.
- Blokpoel, H., and M. C. Gauthier. 1974. Migration of lesser Snow and Blue geese in spring across southern Manitoba, Part 2: Influence of weather and prediction of major flights. Canadian Wildlife Service Report Series 32: 1–28.
- Bruderer, B., and A. Boldt. 2001. Flight characteristics of birds: I. Radar measurements of speeds. *Ibis* 143: 178–204.
- Bruderer, B., and P. Steidinger. 1972. Methods of quantitative and qualitative analysis of bird migration with a tracking radar. Pages 151–168 in *Animal orientation and navigation: a symposium*. NASA SP262. U.S. Government Printing Office, Washington, DC.
- Bruderer, B., T. Steuri, and M. Baumgartner. 1995. Short-range high-precision surveillance of nocturnal migration and tracking of single targets. *Israeli Journal of Zoology* 41: 207–220.
- Buckelew, A. R., Jr. and G. A. Hall. 1994. West Virginia Breeding Bird Atlas. University of Pittsburgh Press, Pittsburgh, Pennsylvania. 215 pp.
- Burnham, K. P., and D. R. Anderson. 1998. Model selection and inference: a practical information-theoretic approach. Springer-Verlag, New York, New York, USA.
- Canterbury, R. A. 2002. Phase 1 Avian Risk Assessment for a Proposed Wind Farm in Grant County, West Virginia. Tech. Rpt. prepared for Potesta & Associates, Inc., Charleston, West Virginia. 33 pp.
- Cooper, B. A., R. H. Day, R. J. Ritchie, and C. L. Cranor. 1991. An improved marine radar system for studies of bird migration. *Journal of Field Ornithology* 62: 367–377.
- Cooper, B. A., C. B. Johnson, and E. F. Neuhauser. 1995a. The impact of wind turbines in upstate New York. Pages 607–611 in *Proceedings of Windpower '95 Conference*, Washington, DC.

- Cooper, B. A., C. B. Johnson, and R. J. Ritchie. 1995b. Bird migration near existing and proposed wind turbine sites in the eastern Lake Ontario region. Unpublished report prepared for Niagara–Mohawk Power Corporation, Syracuse, NY, by ABR, Inc., Forest Grove, OR. 71 pp.
- Cooper, B. A., and T. J. Mabee. 2000. Bird migration near proposed wind turbine sites at Wethersfield and Harrisburg, New York. Unpublished report prepared for Niagara–Mohawk Power Corporation, Syracuse, NY, by ABR, Inc., Forest Grove, OR. 46 pp.
- Cooper, B. A., and R. J. Ritchie. 1995. The altitude of bird migration in east-central Alaska: a radar and visual study. *Journal of Field Ornithology* 66: 590–608.
- Day, R. H., and L. C. Byrne. 1990. Avian research program for the Over-the-Horizon Backscatter Central Radar System: radar studies of bird migration, fall 1989. Unpublished report prepared for Metcalf & Eddy/Holmes & Narver, Wakefield, MA, by ABR, Inc., Fairbanks, AK 111 pp.
- Diehl, R. H., R. P. Larkin, and J. E. Black. 2003. Radar observations of bird migration over the Great Lakes. *Auk* 120: 278-290.
- Eastwood, E. 1967. Radar ornithology. Methuen and Co., Ltd., London, United Kingdom. 278 pp.
- Eastwood, E., and G. C. Rider. 1965. Some radar measurements of the altitude of bird flight. *British Birds* 58: 393–426.
- Erickson, W. P., G. D. Johnson, M. D. Stickland, D. P. Young Jr., K. J. Sernka, and R. E. Good. 2001. Avian collisions with wind turbines: a summary of existing studies and comparisons to other sources of avian collision mortality in the United States. National Wind Coordinating Committee, Washington, DC. 62 pp.
- Erickson, W. P., G. D. Johnson, D. P. Young, M. D. Stickland, R. E. Good, M. Bourassa, K. Bay, and K. Sernka. 2002. Synthesis and comparison of baseline avian and bat use, raptor nesting, and mortality information from proposed and existing wind developments. Unpublished report for Bonneville Power Administration, Portland, OR, by WEST, Inc., Cheyenne, WY. 124 pp.
- Evans, W. R. 1994. Nocturnal flight call of Bicknell's Thrush. *Wilson Bull.* 106:55–61.
- Evans, B. 1998. Deadly towers. *Living Bird* 17(2): 5.
- Evans, W. R, K. V. Rosenburg. 2000. Acoustic monitoring of night-migrating birds: a progress report. http://birds.cornell.edu/pifcapemay/evans_rossenberg.html/ (4 April 2000).
- Fristrup, K. 1999. Late night callers. *Bird Conservation* (Winter 1999):11.
- Gauthreaux, S. A., Jr. 1971. A radar and direct visual study of passerine spring migration in southern Louisiana. *Auk* 88: 343–365.
- Gauthreaux, S. A., Jr. 1972. Behavioral responses of migrating birds to daylight and darkness: a radar and direct visual study. *Wilson Bulletin* 84: 136–148.
- Gauthreaux, S. A., Jr. 1978. Migratory behavior and flight patterns. Pages 12–26 in M. Avery, ed. Impacts of transmission lines on birds in flight. U.S. Fish and Wildlife Service, Office of Biological Services, Report No. FWS/OBS-78/48. 151 pp.
- Gauthreaux, S. A. Jr. 1975. Radar ornithology: bird echoes on weather and airport surveillance radars. Clemson, SC, Clemson Univ. Press.
- Gauthreaux, S. A., Jr. 1985a. Radar, electro-optical, and visual methods of studying bird flight near transmission lines. Unpublished final report prepared for Electric Power Research Institute, Palo Alto, CA, by Clemson University, Clemson, SC. 76 pp.
- Gauthreaux, S. A., Jr. 1985b. An avian mobile research laboratory: hawk migration studies. Pages 339–346 in M. Harwood, ed. Proceedings of Hawk Migration Conference IV. Hawk Migration Association of North America, Washington, CT.

- Gauthreaux, S. A., Jr. 1991. The flight behavior of migrating birds in changing wind fields: radar and visual analyses. *American Zoologist* 31: 187–204.
- Graber, R. R., and S. S. Hassler. 1962. The effectiveness of aircraft-type (APS) radar in detecting birds. *Wilson Bulletin* 74: 367–380.
- Gauthreaux, S. A., Jr., and C. G. Belser. 2003. Radar ornithology and biological conservation. *Auk* 120: 266–277.
- Gauthreaux, S. A., Jr., C. G. Belser, and D. van Blaricom. 2003. Using a network of WSR-88D weather surveillance radars to define patterns of bird migration at large spatial scales. Pages 335–346 in P. Berthold, E. Gwinner, and E. Sonnenschein, eds. *Avian Migration*. Springer, Berlin.
- Hall, G. A. and R. K. Bell. 1981. The diurnal migration of passerines along an Appalachian ridge. *American Birds* 35:135–138.
- Harmata, A. R., G. R. Leighty, and E. L. O’Neil. 2003. A vehicle-mounted radar for dual-purpose monitoring of birds. *Wildlife Society Bulletin* 31: 882–886.
- Harmata, A. R., K. M. Podruzny, and J. R. Zelenak. 1998. Avian use of Norris Hill Wind Resource Area, Montana. Unpublished report prepared for National Renewable Energy Laboratory, Golden, CO, by Fish and Wildlife Program, Biology Department, Montana State University, Bozeman, MT. 77 pp.
- Harmata, A. R., K. M. Podruzny, J. R. Zelenak, and M. L. Morrison. 1999. Using marine surveillance radar to study bird movements and impact assessment. *Wildlife Society Bulletin* 27: 44–52.
- Harmata, A. R., K. M. Podruzny, J. R. Zelenak, and M. L. Morrison. 2000. Passage rates and timing of bird migration in Montana. *American Midland Naturalist* 143: 30–40.
- Heintzelman, D. 1975. *The migration of hawks*, Indiana University Press, Bloomington, Indiana, USA
- Hutto, R. L. 2000. On the importance of en route periods to the conservation of migratory landbirds. *Studies in Avian Biology* 20:109–114.
- Johnson, G. D., W. P. Erickson, M. D. Strickland, M. F. Shepherd, and D. A. Shepherd. 2003. Mortality of bats at a large-scale wind power development at Buffalo Ridge, Minnesota. *American Midland Naturalist* 150: 332–342.
- Kerlinger, P. 1995. *How birds migrate*. Stackpole Books, Mechanicsburg, PA. 228 pp.
- Kerlinger P. 2000. Avian mortality at communication towers: a review of recent literature, research, and methodology. Unpubl. report to U.S. Fish and Wildlife Service, Office of Migratory Bird Management, by Curry & Kerlinger LLC, Cape May Point, NJ. 38 p.
- Kerlinger, P. 2003. FAA lighting of wind turbines and bird collisions. Presentation at the NWCC Wildlife Working Group Meeting, 18 November 2003, Washington DC.
- Kerlinger, P., and F. R. Moore. 1989. Atmospheric structure and avian migration. Pages 109–141 in *Current Ornithology*. Vol. 6. Plenum Press, New York, NY.
- Kovach, W. 2003. Oriana version 2.0. Kovach Computing Services, Anglesey, Wales.
- Kunz, T. H., and M. B. Fenton. 2003. *Bat Ecology*. University of Chicago Press, Chicago, IL. 779 pp.
- Larkin, R. P. 1991. Flight speeds observed with radar, a correction: slow “birds” are insects. *Behavioral Ecology and Sociobiology* 29: 221–224.
- Larkin, R. P., B. Evans, and R. H. Diehl. 2002. Nocturnal flight calls of dickcissels and Doppler radar echoes. *Journal of Field Ornithology* 73: 2–8.
- Lowery, G. H., Jr. 1951. A quantitative study of the nocturnal migration of birds. *University of Kansas Museum of Natural History* 3: 361–472.

- Mabee, T. J., and B. A. Cooper. 2002. Nocturnal migration at the Stateline and Vansycle Wind Energy Projects, 2000–2001. Unpublished report prepared for FPL Energy Vansycle, Juno Beach, FL, by ABR, Inc., Forest Grove, OR. 16 pp.
- Manville A. M. 2000. The ABCs of avoiding bird collisions at communication towers: the next steps. In Proceedings of the December 1999 Workshop on Avian interactions with utility structures, Charleston, SC. Electric Power Research Institute, Palo Alto, CA. Report No. 1000736.
- Nelson, H. K., and R. C. Curry. 1995. Assessing avian interactions with windplant development and operation. Transactions of the North American Wildlife and Natural Resources Conference 60: 266–287.
- Nisbet, I. C. T. 1963. Measurements with radar of the height of nocturnal migration over Cape Cod, Massachusetts. *Bird-Banding* 34: 57–67.
- Osborn R.G., Higgins K.F., Usgaard R.E., Dieter C.D., Neiger R.D. 2000. Bird mortality associated with wind turbines at the Buffalo Ridge Wind Resource Area, Minnesota. *Am. Midl. Nat.* 143:41–52.
- Richardson, W. J. 1971. Spring migration and weather in eastern Canada: a radar study. *American Birds* 25: 684–690.
- Richardson, W. J. 1972. Autumn migration and weather in eastern Canada: a radar study. *American Birds* 26: 10–16.
- Richardson, W. J. 1978. Timing and amount of bird migration in relation to weather: a review. *Oikos* 30: 224–272.
- Richardson, W. J. 1990. Timing of bird migration in relation to weather: updated review. Pages 79–100 in E. Gwinner, ed. *Bird migration*. Springer–Verlag, Berlin, Germany.
- Skolnik, M. I. 1980. *Introduction to radar systems*. McGraw-Hill, New York, NY. 581 pp.
- SPSS. 2002. *SPSS for Windows, version 11.5*. SPSS, Inc., Chicago, IL.
- Tuttle, M. D. 1988. *America's neighborhood bats*. University of Texas Press, Austin, TX. 96 pp.
- Weir, R. D. 1976. Annotated bibliography of bird kills at man-made obstacles: a review of the state of the art and solutions. Canadian Wildlife Service, Ottawa, ON, Canada. 85 pp.
- Wiedner, D. S., P. Kerlinger, D. A. Sibley, P. Holt, J. Hough, R. Crossley. 1992. Visible morning flight of neotropical landbird migrants at Cape May, New Jersey. *Auk* 109:500–510.
- Williams, T. C., J. M. Williams, P. G. Williams, and P. Stokstad. 2001. Bird migration through a mountain pass studied with high resolution radar, ceilometers, and census. *Auk* 118:389–403.
- Williams, T. C., J. Settel, P. O'Mahoney, and J. M. Williams. 1972. An ornithological radar. *American Birds* 26: 555–557.
- Williams, W. 2003. Alarming evidence of bat kills in eastern U.S. *Windpower Monthly* 19 (10): 21–23.
- Windpower Monthly . 2003. Birds and bats. *Windpower Monthly* 19 (11): 16.
- Winkelman, J. E. 1995. Bird/wind turbine investigations in Europe. Pages 43–47 and 110–140 in Proceedings of the National Avian–Wind Power Planning Meeting I, Lakewood, CO.
- Zalles, J. I. and Bildstein, K. L. eds. 2000. *Raptor Watch: A global directory of raptor migration sites*. Cambridge, UK: Birdlife International; and Kempton, PA USA: Hawk Mountain Sanctuary (Birdlife Conservation Series No. 9).
- Zar, J. H. 1999. *Biostatistical analysis*. 3rd ed. Prentice-Hall, Inc., Englewood Cliffs, NJ. 663 pp.

Appendix 1. Calculation of ridge-wide passage rate estimates for proposed Mt. Storm wind development area during fall, 2003.

1) Calculations of ridge-wide migration passage rates, per km of front, for proposed Mt. Storm wind development area during fall, 2003.

The mean ridge-wide passage rate (targets/km/h) for fall season (\bar{P}) was derived as

$$\bar{P} = \frac{\bar{C}(\bar{N}/\bar{C}_N + \bar{S}/\bar{C}_S + 1)}{3}.$$

\bar{C} = mean passage rate (targets/km/h) at central site for n nights.

\bar{N} = mean passage rate (targets/km/h) at north site for n_N nights.

\bar{S} = mean passage rate (targets/km/h) at south site for n_S nights.

\bar{C}_N = mean passage rate (targets/km/h) at central site for n_N nights.

\bar{C}_S = mean passage rate (targets/km/h) at central site for n_S nights.

n = total nights sampled.

n_N = total nights sampled at north site.

n_S = total nights sampled at south site.

2) Calculations of ridge-wide migration passage rates for turbine zone (below 125 m) at proposed Mt. Storm wind development during fall, 2003.

n = total nights sampled.

n_N = total nights sampled at north site.

n_S = total nights sampled at south site.

R_C = mean nightly passage rate (targets/km/h) at central site.

R_N = mean nightly passage rate (targets/km/h) at north site.

R_S = mean nightly passage rate (targets/km/h) at south site.

L_C = mean nightly percent of targets below 125 m agl at central site.

L_N = mean nightly percent of targets below 125 m agl at north site.

L_S = mean nightly percent of targets below 125 m agl at south site.

Appendix 1. Continued.

Season-wide passage rates of targets below 125 m agl (\bar{B}) were calculated as

$$\bar{B}_C = \frac{\sum_{i=1}^n (R_{Ci} * L_{Ci})}{n},$$

$$\bar{B}_N = \frac{\sum_{i=1}^{n_N} (R_{Ni} * L_{Ni})}{n_N}, \text{ and}$$

$$\bar{B}_S = \frac{\sum_{i=1}^{n_S} (R_{Si} * L_{Si})}{n_S};$$

and comparative passage rates below 125 m at the central site were

$$\bar{B}_{C_N} = \frac{\sum_{i=1}^{n_N} (R_{Ci} * L_{Ci})}{n_N} \text{ and}$$

$$\bar{B}_{C_S} = \frac{\sum_{i=1}^{n_S} (R_{Ci} * L_{Ci})}{n_S}.$$

Note that mean nightly passage rates (R_C) for these last two equations were calculated only from sessions with concurrent observations at the respective secondary sites.

The fall mean of ridge-wide passage rates (targets/km/h) for targets below 125 m agl (\bar{P}_{125}) was then derived as

$$\bar{P}_{125} = \frac{\bar{B}_C (\bar{B}_N / \bar{B}_{C_N} + \bar{B}_S / \bar{B}_{C_S} + 1)}{3}.$$

Appendix 2. Paired comparisons of nocturnal flight directions of radar targets from sites at Mt. Storm, WV, during fall 2003 (n = number of radar targets). Nights were divided into early (2030–2300 h) and late (2330–0200 h) periods.

Date	Early		Late	
	Site comparison	Mean direction, angular deviation (n)	Site comparison	Mean direction, angular deviation (n)
03-Sept	Central : East	105°, 47 (22)	Central : East	91°, 57 (6)
04-Sept	Central : North	157°, 20 (19)	Central : North	156°, 31 (16)
05-Sept	Central : South	204°, 35 (43)	Central : South	226°, 50 (37)
06-Sept	Central : West	263°, 35 (49)	Central : West	230°, 33 (58)
07-Sept	Central : North	211°, 42 (58)	Central : South	220°, 36 (65)
08-Sept	Central : East	236°, 39 (61)	Central : West	251°, 22 (72)
09-Sept	Central : South	-	Central : North	-
10-Sept	Central : West	210°, 45 (38)	Central : East	219°, 32 (41)
11-Sept	Central : South	232°, 37 (44)	Central : North	238°, 27 (48)
12-Sept	Central : East	258°, 17 (12)	Central : West	256°, 11 (4)
13-Sept	Central : South	201°, 54 (4)	Central : South	275°, 60 (6)
14-Sept	Central : West	162°, 49 (21)	Central : East	61°, 47 (37)
15-Sept	Central : North	139°, 15 (221)	Central : South	162°, 17 (228)
16-Sept	Central : East	161°, 24 (73)	Central : West	182°, 33 (86)
17-Sept	Central : South	236°, 30 (91)	Central : North	240°, 24 (99)
19-Sept	Central : West	109°, 34 (61)	Central : East	96°, 40 (47)
20-Sept	Central : North	194°, 67 (9)	Central : South	329°, 34 (21)
21-Sept	Central : East	336°, 35 (40)	Central : West	330°, 16 (51)
22-Sept	-	-	Central : North	119°, 22 (24)
23-Sept	Central : West	150°, 24 (56)	Central : East	142°, 20 (56)
24-Sept	Central : North	10°, 61 (36)	Central : South	21°, 47 (40)
25-Sept	Central : East	110°, 43 (27)	Central : West	28°, 69 (39)
26-Sept	Central : South	318°, 35 (62)	Central : South	324°, 30 (53)
27-Sept	Central : West	57°, 56 (7)	Central : East	130°, 23 (52)
28-Sept	Central : South	149°, 25 (38)	Central : South	131°, 19 (41)
29-Sept	Central : South	139°, 19 (50)	Central : West	151°, 15 (78)
30-Sept	Central : North	113°, 29 (43)	Central : East	90°, 41 (25)

Appendix 2. Continued.

Date	Early		Late	
	Site comparison	Mean direction, angular deviation (n)	Site comparison	Mean direction, angular deviation (n)
1-Oct	Central : West	133 27 (65) :	Central : East	123°, 24 (54) :
2-Oct	Central : North	163 20 (56) :	Central : South	177°, 28 (82) :
3-Oct	Central : East	10°, 57 (37) :	Central : West	32°, 50 (17) :
4-Oct	Central : South	132°, 33 (27) :	Central : North	136°, 29 (39) :
5-Oct	Central : West	157°, 29 (38) :	Central : East	184°, 36 (39) :
6-Oct	Central : North	200°, 54 (23) :	Central : South	240°, 56 (30) :
7-Oct	Central : East	-	Central : West	-
8-Oct	Central : South	271°, 33 (78) :	Central : North	314°, 53 (52) :
9-Oct	Central : West	240°, 33 (63) :	Central : East	265°, 25 (78) :
10-Oct	Central : West	212°, 28 (143) :	Central : South	234°, 23 (72) :
11-Oct	Central : North	260°, 37 (59) :	Central : East	252°, 39 (71) :
12-Oct	Central : South	119°, 12 (23) :	Central : North	169°, 17 (36) :
13-Oct	Central : West	258°, 42 (82) :	Central : East	313°, 23 (61) :
15-Oct	Central : North	140°, 12 (51) :	Central : South	136°, 14 (78) :
16-Oct	Central : West	49°, 72 (18) :	Central : East	172°, 41 (60) :
17-Oct	Central : East	220°, 43 (43) :	Central : North	196°, 23 (170) :
				188°, 51 (5)
				161°, 20 (29)
				-
				144°, 38 (44)
				203°, 18 (37)
				249°, 34 (68)
				222°, 48 (30)
				315°, 50 (30)
				205°, 13 (20)
				252°, 31 (19)
				193°, 16 (41)
				178°, 19 (88)
				287°, 33 (76)
				138°, 16 (85)
				201°, 61 (11)
				191°, 23 (77)

Appendix 3. Paired comparisons of mean nightly passage rates of radar targets between sites at Mt. Storm, WV, during fall 2003 (n = number of sessions). Each night was divided into an early (2030–2300 h) and late (2330–0200 h) period.

Date	Site comparison	Early		Late	
		Mean \pm SE (n)	Mean \pm SE (n)	Site comparison	Mean \pm SE (n)
03-Sept	Central : East	16 \pm 2 (3)	0 \pm - (1)	Central : East	12 \pm 8 (2)
04-Sept	Central : North	39 \pm 29 (2)	2 \pm 2 (2)	Central : North	22 \pm 1 (3)
05-Sept	Central : South	304 \pm 139 (3)	17 \pm 7 (3)	Central : South	127 \pm 42 (3)
06-Sept	Central : West	125 \pm 17 (3)	87 \pm 30 (3)	Central : West	127 \pm 15 (3)
07-Sept	Central : North	128 \pm 36 (3)	57 \pm 18 (3)	Central : South	141 \pm 22 (3)
08-Sept	Central : East	128 \pm 28 (3)	28 \pm 6 (3)	Central : West	198 \pm 14 (2)
09-Sept	Central : South	-	29 \pm 16 (3)	Central : North	-
10-Sept	Central : West	119 \pm 5 (3)	31 \pm 1 (3)	Central : East	200 \pm 29 (3)
11-Sept	Central : South	80 \pm 20 (3)	145 \pm 7 (2)	Central : North	88 \pm 5 (3)
12-Sept	Central : East	27 \pm 5 (2)	0 \pm - (1)	Central : West	56 \pm - (1)
13-Sept	Central : South	1 \pm 1 (3)	5 \pm 5 (2)	Central : South	18 \pm 2 (2)
14-Sept	Central : West	22 \pm 3 (3)	81 \pm 17 (3)	Central : East	41 \pm 14 (3)
15-Sept	Central : North	308 \pm 100 (3)	246 \pm 21 (3)	Central : South	309 \pm 61 (3)
16-Sept	Central : East	402 \pm 70 (3)	23 \pm 3 (3)	Central : West	455 \pm 40 (3)
17-Sept	Central : South	478 \pm 36 (3)	205 \pm 18 (3)	Central : North	657 \pm 55 (3)
19-Sept	Central : West	133 \pm 31 (3)	55 \pm 21 (3)	Central : East	99 \pm 20 (3)
20-Sept	Central : North	46 \pm 6 (2)	367 \pm 64 (3)	Central : South	9 \pm 7 (3)
21-Sept	Central : East	69 \pm 13 (3)	57 \pm 15 (3)	Central : West	82 \pm 16 (3)
22-Sept	-	-	-	Central : North	90 \pm 11 (3)
23-Sept	Central : West	527 \pm 177 (3)	156 \pm 52 (3)	Central : East	722 \pm 86 (3)
24-Sept	Central : North	159 \pm 14 (3)	106 \pm 34 (3)	Central : South	251 \pm 34 (3)
25-Sept	Central : East	47 \pm 7 (3)	16 \pm 5 (3)	Central : West	69 \pm 10 (3)
26-Sept	Central : South	135 \pm 40 (3)	80 \pm 6 (3)	Central : South	153 \pm 30 (3)
27-Sept	Central : West	18 \pm 4 (2)	40 \pm - (1)	Central : East	207 \pm 96 (3)
28-Sept	Central : South	177 \pm 12 (3)	418 \pm 121 (3)	Central : South	117 \pm 28 (3)
29-Sept	Central : South	267 \pm 22 (3)	346 \pm 110 (3)	Central : West	403 \pm 7 (3)
30-Sept	Central : North	177 \pm 14 (3)	132 \pm 32 (3)	Central : East	152 \pm - (1)

Appendix 3. Continued.

Date	Early		Late	
	Site comparison	Mean \pm SE (n)	Site comparison	Mean \pm SE (n)
1-Oct	Central : West	162 \pm 24 (3)	Central : East	169 \pm 5 (3)
2-Oct	Central : North	472 \pm 57 (3)	Central : South	564 \pm 67 (3)
3-Oct	Central : East	158 \pm 51 (3)	Central : West	135 \pm 12 (2)
4-Oct	Central : South	287 \pm 55 (3)	Central : North	204 \pm 17 (3)
5-Oct	Central : West	745 \pm 162 (3)	Central : East	959 \pm 81 (3)
6-Oct	Central : North	744 \pm 70 (3)	Central : South	520 \pm 138 (3)
7-Oct	Central : East	-	Central : West	-
8-Oct	Central : South	369 \pm 74 (3)	Central : North	153 \pm 38 (3)
9-Oct	Central : West	251 \pm 42 (3)	Central : East	384 \pm 53 (3)
10-Oct	Central : West	604 \pm 76 (3)	Central : South	275 \pm 159 (3)
11-Oct	Central : North	159 \pm 53 (3)	Central : East	255 \pm 58 (3)
12-Oct	Central : South	-	Central : North	-
13-Oct	Central : West	266 \pm 16 (3)	Central : East	247 \pm 52 (3)
15-Oct	Central : North	812 \pm 8 (2)	Central : South	507 \pm 73 (3)
16-Oct	Central : West	50 \pm 6 (2)	Central : East	106 \pm 66 (3)
17-Oct	Central : East	206 \pm 186 (2)	Central : North	701 \pm 63 (3)

Appendix 4. Paired comparisons of mean nightly flight altitudes of radar targets from sites at Mt. Storm, West Virginia, during fall 2003. Nights were divided into early (2030-2300 hrs) and late (2330-0200 hrs) periods. *n* = number of radar targets.

Date	Site comparison	Early		Late	
		Mean ± SE (<i>n</i>)	Mean ± SE (<i>n</i>)	Site comparison	Mean ± SE (<i>n</i>)
03-Sept	Central : East	403 ± 22 (79)	-	-	-
04-Sept	Central : North	505 ± 42 (26)	570 ± 23 (33)	Central : North	575 ± 18 (7)
05-Sept	Central : South	580 ± 14 (214)	620 ± 45 (24)	Central : South	551 ± 40 (35)
06-Sept	Central : West	618 ± 34 (58)	464 ± 29 (82)	Central : West	571 ± 29 (52)
07-Sept	Central : North	514 ± 44 (28)	421 ± 40 (17)	Central : South	438 ± 27 (52)
08-Sept	Central : East	439 ± 12 (168)	624 ± 45 (32)	Central : West	387 ± 11 (181)
10-Sept	Central : West	533 ± 27 (50)	517 ± 42 (19)	Central : East	475 ± 16 (103)
11-Sept	Central : South	435 ± 15 (150)	406 ± 27 (42)	Central : North	389 ± 14 (157)
13-Sept	Central : South	716 ± 115 (16)	496 ± 79 (4)	Central : South	827 ± 52 (14)
14-Sept	Central : West	701 ± 47 (74)	544 ± 65 (31)	Central : East	746 ± 41 (75)
15-Sept	Central : North	428 ± 17 (314)	494 ± 20 (151)	Central : South	458 ± 13 (383)
16-Sept	Central : East	697 ± 36 (88)	613 ± 20 (218)	Central : West	534 ± 15 (445)
17-Sept	Central : South	422 ± 11 (498)	451 ± 15 (214)	Central : North	292 ± 7 (460)
19-Sept	Central : West	361 ± 18 (219)	390 ± 26 (93)	Central : East	305 ± 23 (72)
20-Sept	Central : North	729 ± 36 (48)	579 ± 35 (124)	Central : South	606 ± 16 (113)
21-Sept	Central : East	680 ± 24 (183)	441 ± 15 (168)	Central : West	583 ± 33 (106)
22-Sept	-	-	-	Central : North	214 ± 13 (41)
23-Sept	Central : West	347 ± 9 (604)	518 ± 12 (220)	Central : East	270 ± 11 (371)
24-Sept	Central : North	555 ± 18 (320)	660 ± 30 (128)	Central : South	416 ± 19 (230)
25-Sept	Central : East	452 ± 27 (111)	462 ± 15 (137)	Central : West	589 ± 26 (153)
26-Sept	Central : South	353 ± 24 (182)	420 ± 29 (112)	Central : South	257 ± 31 (89)
28-Sept	Central : South	510 ± 14 (460)	405 ± 12 (639)	Central : South	460 ± 18 (424)
29-Sept	Central : South	349 ± 15 (346)	373 ± 13 (327)	Central : West	331 ± 9 (441)
30-Sept	Central : North	333 ± 17 (273)	494 ± 22 (247)	Central : East	246 ± 20 (49)

Appendix 4. Continued.

Date	Early		Late	
	Site comparison	Mean \pm SE (<i>n</i>)	Site comparison	Mean \pm SE (<i>n</i>)
1-Oct	Central : West	556 \pm 20 (291)	-	-
2-Oct	Central : North	441 \pm 14 (490)	Central : South	486 \pm 14 (507)
3-Oct	Central : East	214 \pm 18 (104)	-	-
4-Oct	Central : South	231 \pm 13 (128)	-	-
5-Oct	Central : West	316 \pm 8 (727)	Central : East	293 \pm 7 (752)
6-Oct	Central : North	283 \pm 8 (575)	Central : South	339 \pm 10 (555)
8-Oct	Central : South	609 \pm 20 (317)	Central : North	653 \pm 23 (164)
9-Oct	-	-	Central : East	395 \pm 19 (222)
10-Oct	Central : West	501 \pm 16 (301)	Central : South	528 \pm 13 (430)
11-Oct	Central : North	478 \pm 21 (242)	Central : East	462 \pm 16 (309)
13-Oct	Central : West	487 \pm 15 (362)	Central : East	417 \pm 22 (149)
15-Oct	Central : North	250 \pm 12 (317)	Central : South	235 \pm 12 (235)
16-Oct	-	-	Central : East	363 \pm 13 (184)
17-Oct	Central : East	302 \pm 22 (91)	Central : North	378 \pm 8 (499)

Appendix 5. AIC modeling of the effects of weather on migration passage rates and flight altitudes at Mt. Storm, West Virginia, during fall 2003.

METHODS

We modeled the influence of weather and date separately on the dependent variables passage rates and flight altitudes. We obtained our weather data (i.e., wind speed and direction) from 50-m meteorological towers located near the central and northern sites. All wind categories except the calm category had a mean wind speed of ≥ 2.2 m/s (i.e., ≥ 5 mph) and were categorized as the following: tailwinds, WNW to ENE (i.e., 293° – 068°), headwinds ESE to SSW (i.e., 113° – 248°), eastern crosswinds (069° – 112°), western crosswinds (249° – 292°), and calm (< 2.2 m/s).

Prior to model specification, we examined the data for redundant variables (Spearman's $r_s > 0.70$) and retained all 5 parameters for inclusion in the model. We examined scatterplots and residual plots to ensure that variables met assumptions of analyses (i.e., linearity, normality, collinearity) and did not contain presumed outliers (> 4 SE). We used a square-root transformation on both dependent variables to approximate normality. We specified 12 models: a global model containing all 5 parameters and subset models representing potential influences of weather variables and date on migration passage rates and flight altitudes. We analyzed both model sets with linear regression. Prior to model selection, we examined fit of global models following recommendations of Burnham and Anderson (1998) that included examining residuals and measures of fit ($R^2 = 0.38$ and 0.30 , respectively, for passage-rate and flight-altitude models).

Because the number of sessions sampled for passage rates ($n = 217$) and flight altitudes ($n = 185$) was small relative to the number of parameters (K) in many models (i.e., $n/K < 40$), we used Akaike's Information Criterion corrected for small sample size (AICc) for model selection (Burnham and Anderson 1998). We used the formulas presented in Burnham and Anderson (1998) to calculate AICc for our least-squares (linear regression) methods. We ranked all candidate models according to their AICc values, and the best model (i.e., most parsimonious) was the model with the smallest AICc value (Burnham and Anderson 1998). We drew primary inference from models within 2 units of the minimal AICc value, although models within 4–7 units may have some empirical support (Burnham and Anderson 1998). We calculated Akaike weights (w_i) to determine the weight of evidence in favor of each model and to estimate the

relative importance of individual parameters (Burnham and Anderson 1998). All analyses were conducted with SPSS software (SPSS 2002).

RESULTS

PASSAGE RATES

The best approximating model explaining migration passage rates of nocturnal migrants during fall migration was the model containing the variables date, wind direction, and ceiling height (Table A5.1). The second-best model, the global model containing date, wind direction, ceiling height, wind speed, and fog, also received strong empirical support ($\Delta AIC_c = 1.55$; Table A5.1). Both models contained the same strong positive associations with date, tailwinds, and eastern and western crosswinds and strong negative associations with low ceiling heights (i.e., <500 m agl; Table A5.2). Calm wind directions, wind speed, and fog were not related to passage rates. The weight of evidence in favor of the “best” model ($w_{\text{best}}/w_{\text{second best}}$; Burnham and Anderson 1998), was only ~ 2.1 times greater than that of the global model, indicating some

Table A5.1. Linear regression models explaining their influence on migration passage rates of radar targets at the Mt. Storm central site, WV, during fall 2003 ($n = 217$ sessions). Model weights (w_i) were based on Akaike’s Information Criterion (AIC).

Model	RSS ^a	K ^b	AIC _c ^c	ΔAIC_c ^d	w_i ^e
Date + wind direction + ceiling height	6,989.7	8	770.18	0.00	0.68
Global model: date + wind direction + wind speed + ceiling height + fog	6,899.3	10	771.73	1.55	0.32
Date + ceiling height	7,881.1	4	787.72	17.54	0.00
Date + wind direction	7,994.3	7	797.17	26.98	0.00
Date + wind direction + fog	7,994.3	8	799.32	29.14	0.00
Date	9,118.1	3	817.28	47.10	0.00
Fog + date	9,114.9	4	819.28	49.10	0.00
Ceiling height	9,864.4	3	834.36	64.18	0.00
Wind direction	10,208.4	6	848.08	77.90	0.00
Wind direction + wind speed	10,170.5	7	849.41	79.23	0.00
Wind speed	10,978.5	3	857.58	87.40	0.00
Fog	11,164.1	3	1,359.95	589.77	0.00

^a Residual sum of squares.

^b Number of estimable parameters in approximating model.

^c Akaike’s Information Criterion corrected for small sample size.

^d Difference in value between AIC_c of the current model versus the best approximating model with the minimal AIC_c value.

^e Akaike weight—probability that the current model (i) is the best approximating model among those being considered.

Table A5.2. Parameter estimates from the two best models explaining their influence on passage rates of radar targets at the Mt. Storm central site, WV, during fall 2003 ($n = 217$ sessions). Coefficients (B) of the categorical variables (wind direction, ceiling height, fog) were calculated relative to headwinds, high ceiling height (>500 m agl), and fog conditions.

Model	B	SE	R ²
Date + wind direction + ceiling height			0.374
Intercept	-53.600	8.596	
Date	0.251	0.032	
Wind direction = tailwind	4.058	1.156	
Wind direction = calm	-0.356	1.935	
Wind direction = E crosswind	5.454	1.358	
Wind direction = W crosswind	3.039	0.977	
Ceiling height <500 m agl	-4.828	0.879	
Global model:			
Date + wind direction + wind speed + ceiling height + fog			0.382
Intercept	-52.060	8.640	
Date	0.254	0.032	
Wind direction = tailwind	3.876	1.162	
Wind direction = calm	-0.897	2.050	
Wind direction = easterly crosswind	5.057	1.379	
Wind direction = westerly crosswind	3.568	1.091	
Wind speed	-0.109	0.172	
Ceiling height <500 m agl	-5.269	0.917	
Fog = absent	-1.876	1.222	

uncertainty in selection of the best candidate model (Burnham and Anderson 1998). Summing Akaike weights ($\sum w_i$) of parameters across all models provided evidence for the relative importance of variables from these models, with wind direction (1.00) being more important than date, wind speed, ceiling height, and fog (all 0.68). The remaining 10 model sets received no empirical support ($\Delta AICc > 17$, $w_i = 0.00$; Table A5.1).

FLIGHT ALTITUDES

The best approximating model explaining flight altitudes of nocturnal migrants during fall migration was the global model containing the variables date, wind direction, wind speed, ceiling height, and fog (Table A5.3). The second-best model contained date, wind direction, and ceiling height but received limited empirical support ($\Delta AICc = 3.37$; Table A5.3). Both models

Table A5.3. Linear regression models explaining the influence of environmental factors on mean flight altitudes of radar targets at the Mt. Storm central site, WV, during fall 2003 ($n = 185$ sessions). Model weights (w_i) were based on Akaike's Information Criterion (AIC).

Model	RSS ^a	K ^b	AIC _c ^c	Δ AIC _c ^d	w_i ^e
Global model: date + wind direction + wind speed + ceiling height + fog	1,858.8	10	448.12	0.00	0.77
Date + wind direction + ceiling height	1,939.0	8	451.49	3.37	0.14
Date + wind direction + fog	1,949.9	8	452.53	4.41	0.08
Date + wind direction	2,030.0	7	457.79	9.67	0.01
Wind direction + wind speed	2,102.0	7	464.24	16.12	0.00
Wind direction	2,225.1	6	472.60	24.48	0.00
Fog + date	2,278.1	4	472.71	24.59	0.00
Wind speed	2,309.2	3	473.13	25.01	0.00
Date + ceiling height	2,283.5	4	473.15	25.03	0.00
Date	2,416.0	3	481.49	33.37	0.00
Fog	2,564.6	3	492.53	44.41	0.00
Ceiling height	2,635.9	3	497.61	49.49	0.00

^a Residual sum of squares.

^b Number of estimable parameters in approximating model.

^c Akaike's Information Criterion corrected for small sample size.

^d Difference in value between AIC_c of the current model versus the best approximating model with the minimum AIC_c value.

^e Akaike weight—probability that the current model (i) is the best approximating model among those being considered.

contained strong negative associations with date and western crosswinds, and the second-best model also contained a strong negative association with low ceiling heights (i.e., <500 m agl; Table A5.4). Wind speed and fog were not related to flight altitudes. The weight of evidence in favor of the “best” model ($w_{\text{best}}/w_{\text{second best}}$) was 5.5 times greater than that of the second best model. The Σw_i suggested that both wind direction (0.92) and wind speed (0.86) were more important than date, ceiling height, and fog (all 0.68). The third-best model containing the variables date, wind direction, and fog also received marginal support ($\Delta\text{AIC}_c = 4.41$) whereas the remaining 9 model sets received no empirical support ($\Delta\text{AIC}_c > 9$; $w_i \leq 0.08$; Table A5.3).

DISCUSSION

MIGRATION PASSAGE RATES

It is a well-known fact that general weather patterns and their associated temperatures and winds affect migration (Richardson 1978, 1990). In the Northern Hemisphere, air moves counterclockwise around low-pressure systems and clockwise around high-pressure ones. Thus, winds are warm and southerly when an area is affected by a low to the west or a high to the east

Table A5.4. Parameter estimates from the two best models explaining the influence of environmental factors on mean flight altitudes of radar targets at the Mt. Storm central site, WV, during fall 2003 ($n = 185$ sessions). Coefficients (B) of the categorical variables (wind direction, ceiling height, fog) were calculated relative to headwinds, high ceiling height (>500 m agl), and fog conditions.

Model	B	SE	R ²
Global model:			
Date + wind direction + wind speed + ceiling height + fog			0.303
Intercept	44.797	5.242	
Date	-0.080	0.020	
Wind direction = tailwind	0.126	0.719	
Wind direction = calm	-0.454	1.315	
Wind direction = easterly crosswind	-1.459	0.907	
Wind direction = westerly crosswind	-2.310	0.686	
Wind speed	-0.222	0.112	
Ceiling height <500 m agl	1.070	0.585	
Fog = absent	-1.189	0.796	
Date + wind direction + ceiling height			0.295
Intercept	44.109	5.214	
Date	-0.087	0.020	
Wind direction = tailwind	0.572	0.699	
Wind direction = calm	0.669	1.232	
Wind direction = easterly crosswind	-0.904	0.859	
Wind direction = westerly crosswind	-2.983	0.611	
Ceiling height <500 m agl	1.599	0.551	

and are cool and northerly in the reverse situation. Clouds, precipitation, and strong, variable winds are typical in the centers of lows and near fronts between weather systems, whereas weather usually is fair with weak or moderate winds in high-pressure areas. Numerous studies in the Northern Hemisphere have shown that, in fall, most bird migration tends to occur in the western parts of lows, the eastern or central parts of highs, or in intervening transitional areas. In contrast, warm fronts, which are accompanied by southerly (unfavorable) winds and warmer temperatures, tend to slow migration in the fall (Lowery 1951, Gauthreaux 1971; Able 1973, 1974; Blokpoel and Gauthier 1974, Richardson 1990). Conversely, spring migration tends to occur in the eastern parts of lows, the western or central parts of highs, or in intervening transitional areas.

We examined the influence of weather and date on migration passage rates and identified the best approximating model containing the variables date, wind direction, and ceiling height. Migration passage rates increased with date (i.e., higher passage rates were observed later in the season) and this pattern was displayed by our figure examining passage rates by date—the highest passage rates occurred in late September and October. Passage rates also increased with tailwinds and eastern or western crosswinds, but decreased with headwinds. This pattern is generally consistent with other studies (Lowery 1951, Gauthreaux 1971; Able 1973, 1974; Blokpoel and Gauthier 1974, Richardson 1990), and wind direction was the strongest variable in our model. Passage rates also decreased with low ceiling heights (i.e., < 500 m agl). Although we are not certain why this latter pattern may have occurred, there are several possible reasons, including (1) birds migrating above the cloud layer (and potentially above the effective sampling range of our radar) and (2) fewer birds migrating because of low ceiling conditions associated with unfavorable migratory conditions.

FLIGHT ALTITUDES

Radar studies have shown that wind is a key factor in migratory flight altitudes (Alerstam 1990). Birds fly mainly at heights at which headwinds are minimized and tailwinds are maximized (Bruderer et al. 1995). Because wind strength generally increases with altitude, bird migration generally takes place at lower altitudes in headwinds and at higher altitudes in tailwinds (Alerstam 1990). Most studies (all except Bellrose 1971) have found that clouds influence flight altitude, but the results are not consistent among studies. For instance, some studies (Bellrose and Graber 1963, Blokpoel and Burton 1975) found that birds flew both below and above cloud layers, whereas others (Nisbet 1963, Able 1970) found that birds tended to fly below clouds.

The best approximating model explaining flight altitudes was the global model containing the variables date, wind direction, wind speed, ceiling height, and fog. Flight altitudes decreased with date (i.e., lower flight altitudes were observed later in the season), with the lowest flight altitudes occurring in late September and October. Flight altitudes also decreased with western crosswinds, a pattern not consistent with other studies (see above). The remaining variables (wind speed, ceiling height, fog) did not have a strong influence on flight altitudes.

In this study, we examined the hourly relationships between passage rates, flight altitudes, and weather conditions because of the dynamic weather conditions within a night. This treatment

of the data, however, may violate the assumption of statistical independence (between hourly passage rates or flight altitudes) and our results, therefore, may overemphasize the strength of the relationships presented. The ability of weather (and other variables) to influence migration passage rates and flight altitudes of nocturnal birds has been established in many studies, but it will require additional field data under a greater variety of weather conditions to predict those conditions that would put nocturnal migrants at risk of collision with wind turbines. Studies at existing wind power facilities that concurrently examine passage rates and flight altitudes of nocturnal migrants throughout the full migratory seasons are needed to encompass the wide variation in weather conditions that are essential for predictive modeling of these relationships. Large kills of migratory birds have not been documented at wind farms, but they have sporadically occurred at other, taller structures (e.g., guyed and lighted towers >130 m high) in many places across the country during periods of heavy migration, especially on foggy, overcast nights in fall (Weir 1976, Avery et al. 1980, Evans 1998, Erickson et al. 2001). Recently, however, approximately 25 nocturnal spring migrants (passerines) were reported killed on one foggy night near three turbines and a floodlit substation at the Mountaineer wind power development in West Virginia.

METHODS

We compared base reflectivity (representing bird densities) and base velocity (representing bird speeds and flight directions) results from NEXRAD (WSR-88D radar) images to the migration passage rates and flight direction results of our marine radar studies at the proposed Mt. Storm site during September and early October, 2003. We used NEXRAD images from the KPBZ radar station, located near Pittsburgh, PA (UTM 17T 566226E 4487063N; 172 km from the proposed development). For each night analyzed, we used NEXRAD base velocity and base reflectivity images taken at ~2330 h local time.

Because the proposed wind power project is located beyond radar coverage of any NEXRAD station, we calculated reflectivity values for a 20-km-wide band of area, 30-50 km from the KPBZ radar station. At this distance, the NEXRAD beam encompasses the range of flight altitudes of the majority of nocturnal passerine migrants (this study; Bellrose 1971; Gauthreaux 1972, 1978, 1991; Bruderer and Steidinger 1972; Cooper and Ritchie 1995; Kerlinger 1995). Images with precipitation patterns within the sample band were omitted from the analyses. From the base velocity images, we determined the direction of migration as the azimuth perpendicular to a line through the region representing zero radial velocity. Average target velocity was estimated as the median velocity value along the migration axis (in both directions from the station) between 30 km and 50 km from KPBZ.

To eliminate nights with suspected heavy insect contamination, we adjusted our velocity results for wind speeds to determine true airspeed of NEXRAD targets. We used wind velocities from radiosondes launched from the Pittsburgh weather station. Radiosondes are released only twice daily (at 0800 and 2000 EDT); so we used wind data only from the 2000 h launch times, which most-closely represent the time periods of our nightly observations. We calculated and applied wind velocities and directions measured at 500 m agl, approximately the midpoint of the altitudes within the NEXRAD beam in the sample area. Wind-velocity vectors then were subtracted from the base velocity vectors to determine true mean airspeeds of NEXRAD targets. For subsequent analyses, we reduced insect contamination by including data only for nights

where NEXRAD airspeeds were ≥ 6 m/s (Larkin 1991, Bruderer and Boldt 2001, Diehl et al. 2003).

DATA ANALYSES

To compare the Mt. Storm radar results with the NEXRAD data, we computed correlation coefficients between mean hourly rates of radar targets at the Mt. Storm central site and mean, median, and maximal reflectivity values in the NEXRAD sample area for non-insect nights between 3 September and 10 October. Because reflectivity values represent logarithmic densities, we log-transformed passage rates prior to analysis. By using an insect airspeed threshold of 6 m/s, we still were able to include 22 nights in the analyses. We also compared nightly mean flight directions of targets at the Mt. Storm central site with the mean direction of broad-scale migration from the KPBZ base velocity images using the Mardia–Watson–Wheeler (Uniform Scores) test for paired comparisons (Oriana software version 2.0).

RESULTS

For 23 nights with comparable data, nightly flight directions of radar targets at the Mt. Storm central site (mean = $160^\circ \pm 16^\circ$) did not differ from concurrent directions of broad-front migration (mean = $166^\circ \pm 14^\circ$), as determined from base velocity images of the WSR-88 ($W = 0.68$, $n = 23$, $P = 0.71$). We found only weak correlations, however, between NEXRAD reflectivity values (representing bird densities) and radar migration passage rates for those nights (mean reflectivity: $r^2 = 0.13$; median reflectivity: $r^2 = 0.06$; maximal reflectivity: $r^2 = 0.09$).

DISCUSSION

Doppler weather radar systems have recently been used to describe large-scale patterns of bird migration, both quantitatively and qualitatively (Larkin et al. 2002, Diehl et al. 2003, Gauthreaux and Belser 2003, Gauthreaux et al. 2003). Although there currently are 151 WSR-88D (NEXRAD) radar stations operating throughout the US, effective coverage of the country's landmass is incomplete. The NEXRAD station closest to Mt. Storm is located near Pittsburgh, PA, at a distance of ~ 170 km from the proposed wind power development project, and outside of

Appendix 6. Continued.

the effective coverage area of the base-level radar; so direct comparison of the radar systems is not possible for migration activity at the study site. Nevertheless, some characteristics of nocturnal migration at Mt. Storm hypothetically may be correlated with large-scale migration patterns in the region, as characterized by NEXRAD-generated data. If there was a strong correlation, the weather radar data therefore might be useful as predictors of general passage rates of nocturnal migrants at the project site.