

La Rance Tidal Power Plant

40-year operation feedback – Lessons learnt

BHA Annual Conference – Liverpool – 14 & 15 October 2009

Vincent de Laleu - eDF





Overview

A - Presentation

B - The main technical problems to solve

C - Maintenance

D - Environmental impacts

E - Integration





Unité de Production Centre

GEH OUEST

- Barrage EDF
- Usine EDF
- Barrage producteur autonome, exploité par EDF
- Usine producteur autonome
- Barrage filiale EDF
- Usine filiale EDF
- Base d'intervention

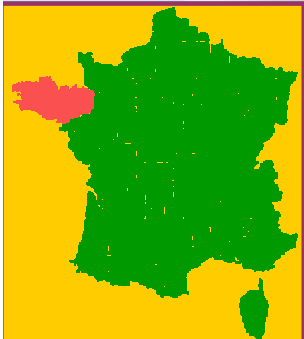
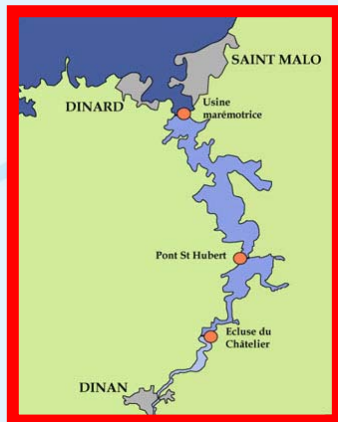



A - Some figures on La Rance tidal power plant...

- Studied between 1943 and 1961, built between 1961 and 1966
- Equipped with 24 bulb-units rated 10MW
- Total installed capacity: 240 MW
- Generation: 540,000,000 kWh/year
- 20,000 boats/year passing the ship lock
- 30,000 up to 60,000 vehicles/day on the road crossing the estuary
- 70,000 visitors per year
- EDF Staff: 28 employees for operation and routine maintenance
- Construction cost: €95m (1967) – about €580m (2009)

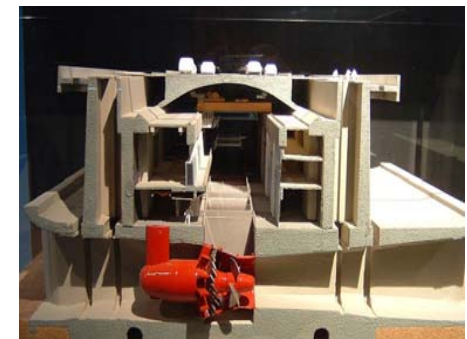
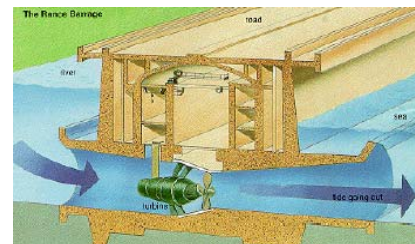



A - Why a Tidal Power Plant in the Rance Estuary ?

- Highest tidal range in France: average 8.2m - maximum 13.5m

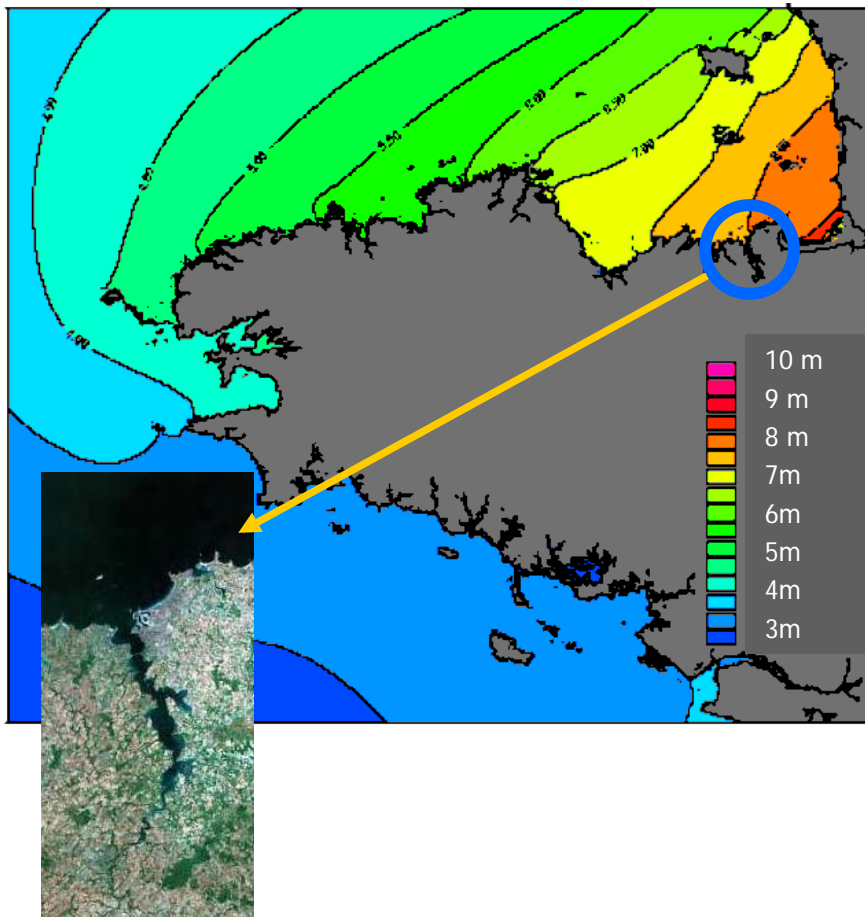

- A large reservoir: 184,000,000m³, spread over more than 20km upstream (22km² basin area)

- Only a 750m wide estuary to be cut off

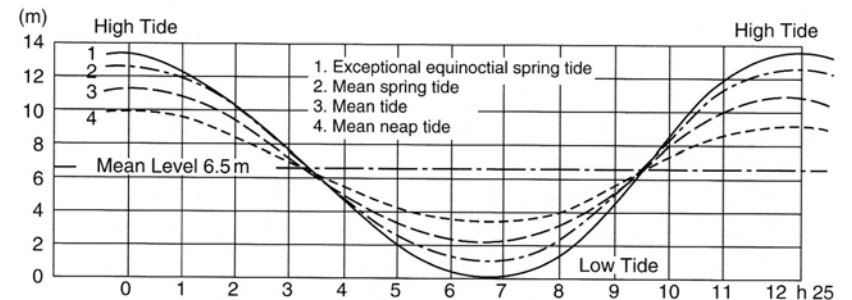



A - Description of the structures



SHIP LOCK 24 UNITS POWER PLANT DIKE BARRAGE 6 GATES

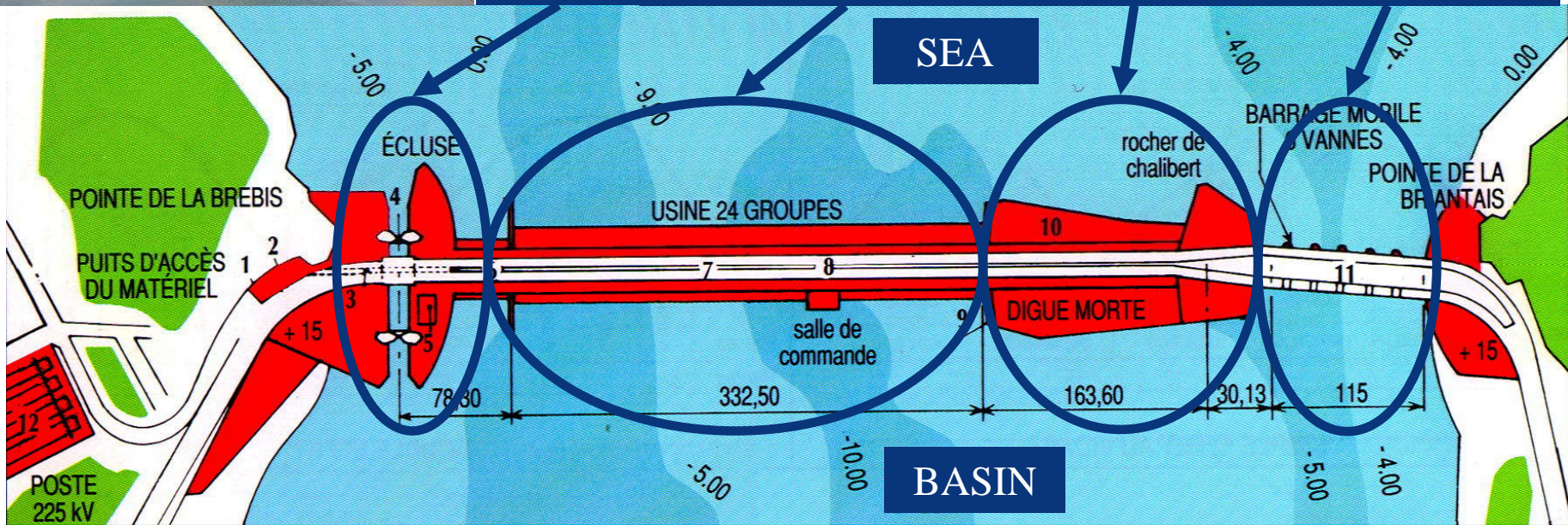



A - Power house



Nota : +0 is the reference of the LAT level
Cross-section of a bulb-unit bay

Length: 332.5m

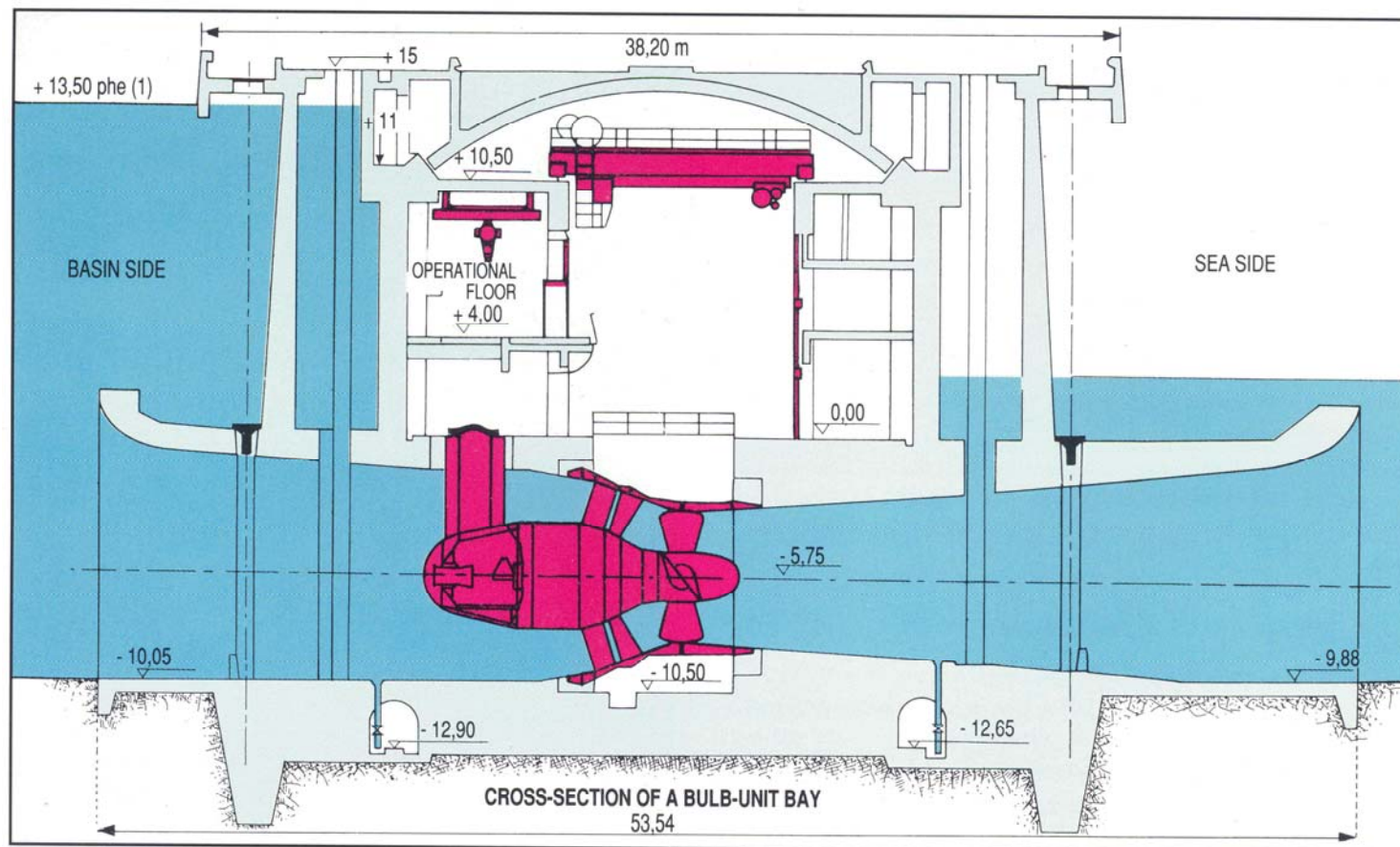



A - Dyke and Barrage

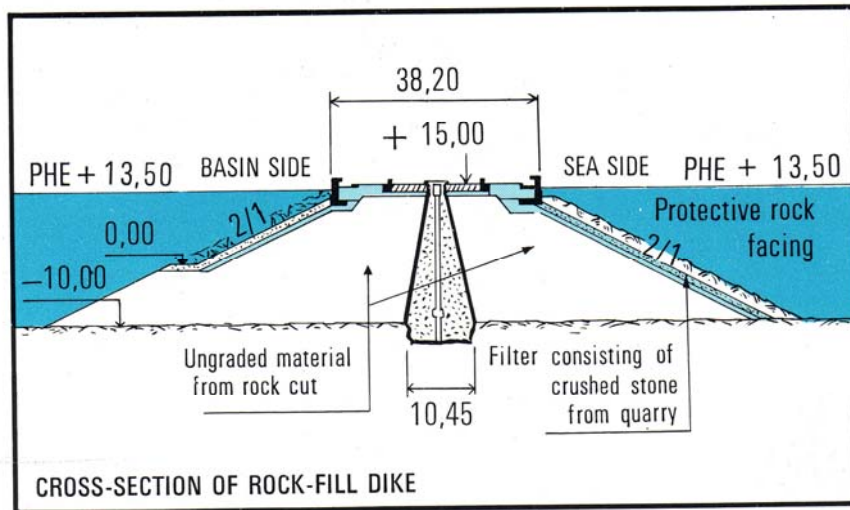

Dyke :

- Length: 163.6m
- Initial Project: 16 additional turbines !

Barrage:

- Length: 145.1m
- 6 gates (H: 10m * W:15m; fixed wheel gates - « Wagon »)
- Maximum flow: 9,600m³/s

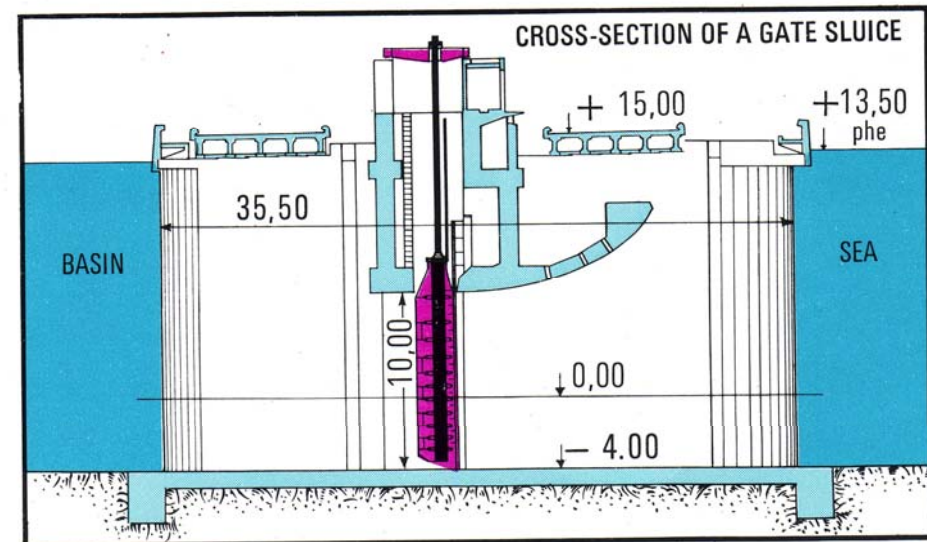



A – Electrical equipment

- 24 x 10 MVA alternators operating in air under 2bar (28.44psi) absolute pressure; AI 3.5kV
- 6 x operational units (« assembly ») comprising 4 bulb-units each: ancillary components in common + turbine adjustment and alternator energizing purposes
- 3 transformers units (3.5/3.5/225kV): 80MVA power, cooled by oil and blown-air circulation
- Connection to the 225kV station by oil-filled cables under pressure

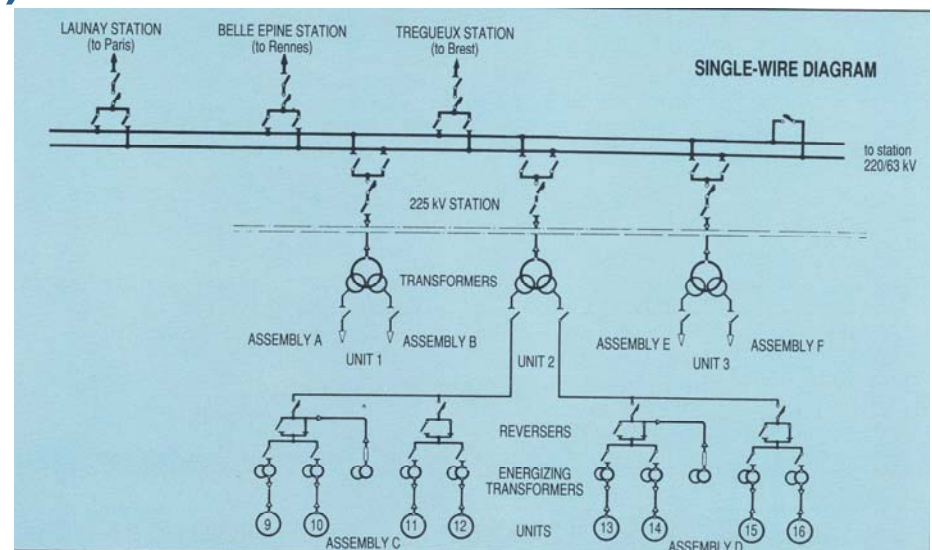
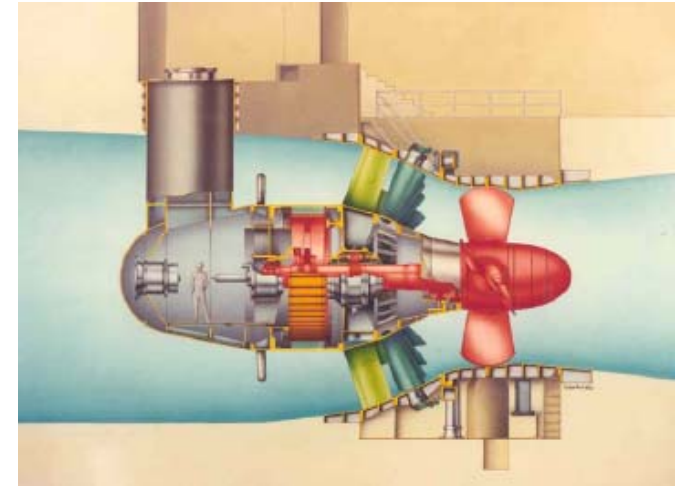



B - The main technical problems to solve

As identified in 1943 by R. Gibrat



1. Operation cycles
2. Choice of the turbines
3. Protection against marine corrosion
4. Construction of the plant

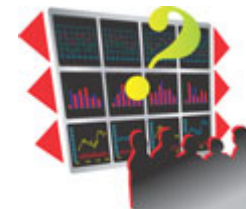

1

The operation cycles

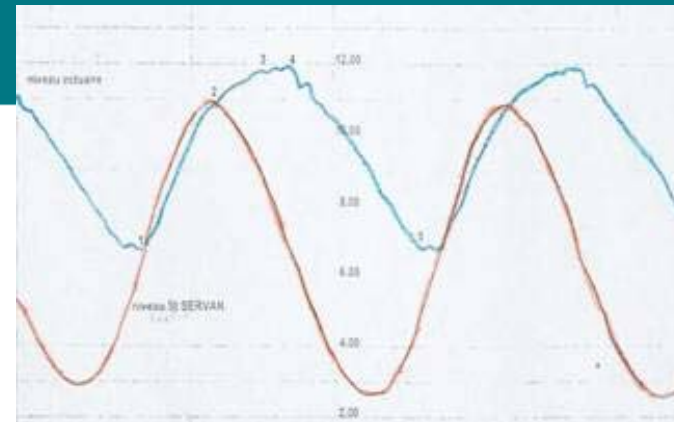
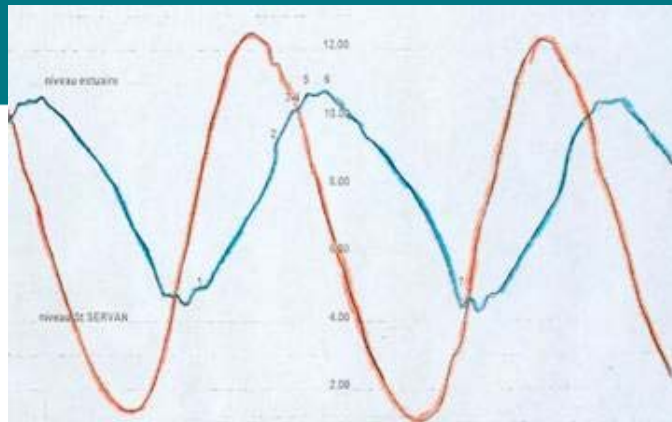



1.1 “Simple effect” - Ebb generation

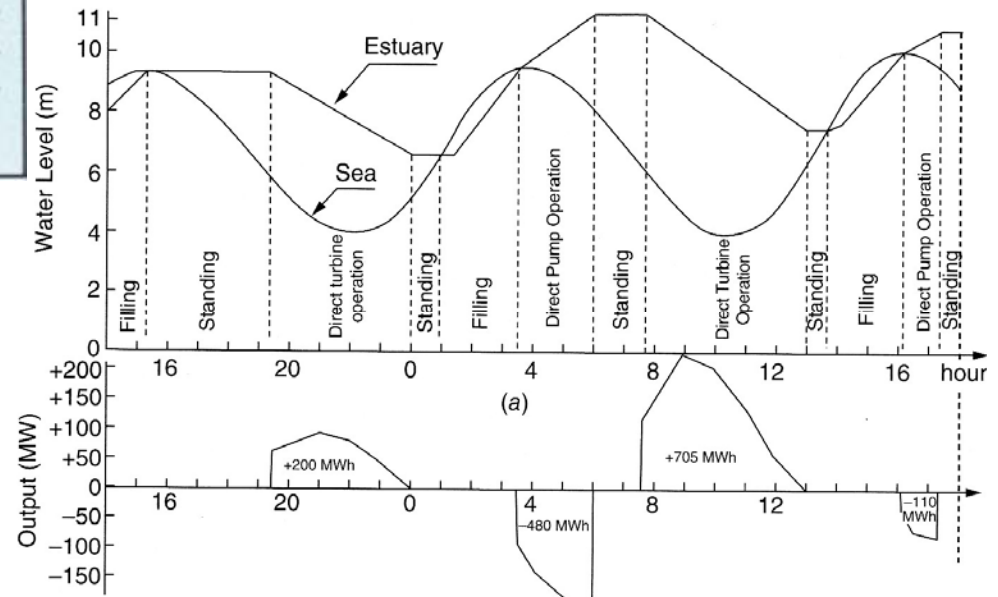
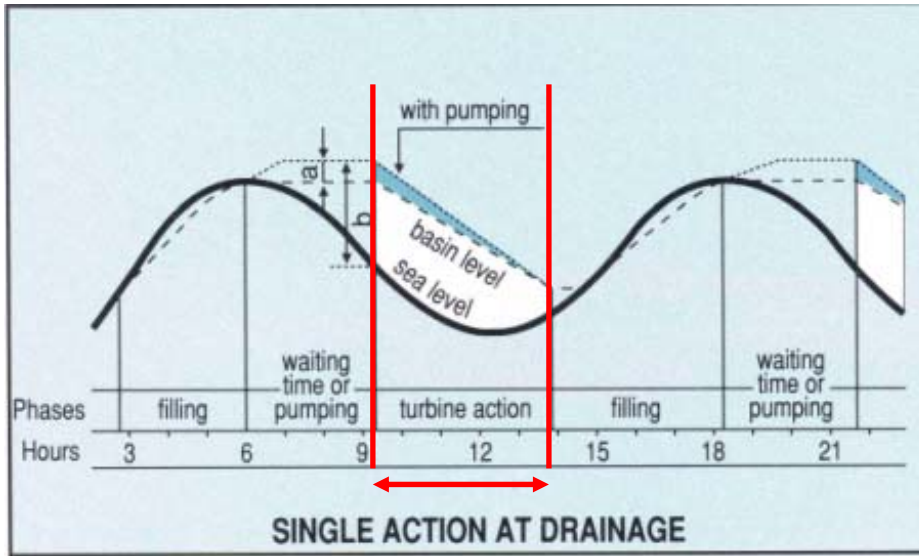

Minimum head for turbines (ebb generation): 1.20m – Maximum reservoir level increased by pumping: +1.75m



1.2 “Double effect” - Ebb & Flood generation

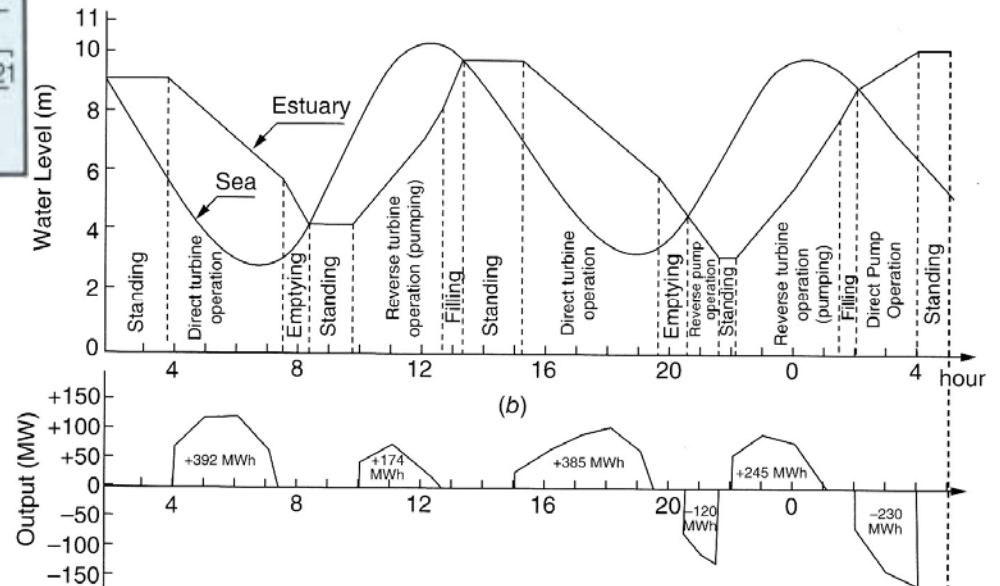
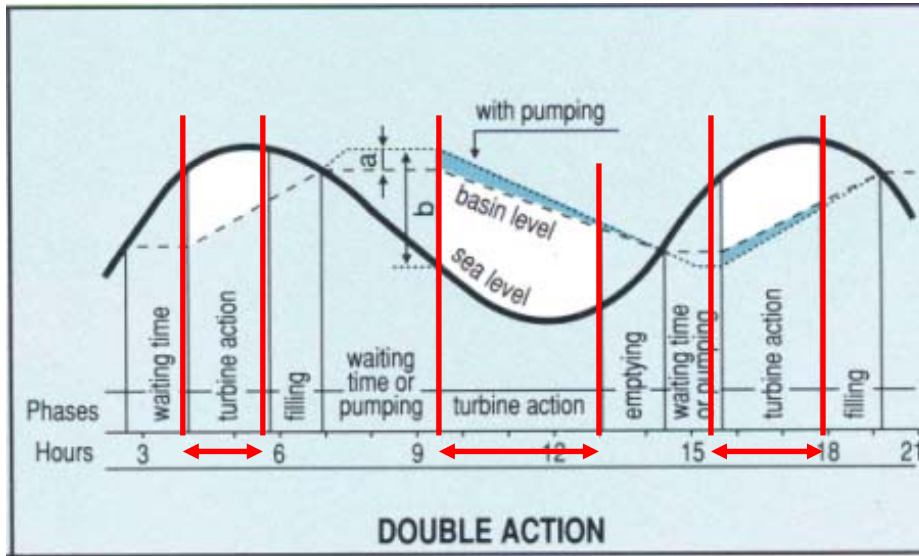

Minimum head for turbines (flood generation): 1.70m

➔ **Choice for La Rance Tidal Power Plant**



1.3 La Rance average operation

- Ebb generation (direct turbinning): 60%
- Reverse pumping (reservoir towards sea): 0%
- Flood generation (reverse turbinning): 2 to 6%
- Direct pumping (sea towards reservoir): 15 to 20%
- Free flow through the turbines orifices (mainly sea towards reservoir): 20% (when $0.3 \text{ m} < \text{Head} < 1.2 \text{ m}$)
- No pumping required when tidal range is above 7 or 10 m

Now, flood generation only during high tides (tidal range > 12m) and maximum pumping capacity 56MW (according to contract with RTE)

2

The choice of the turbines

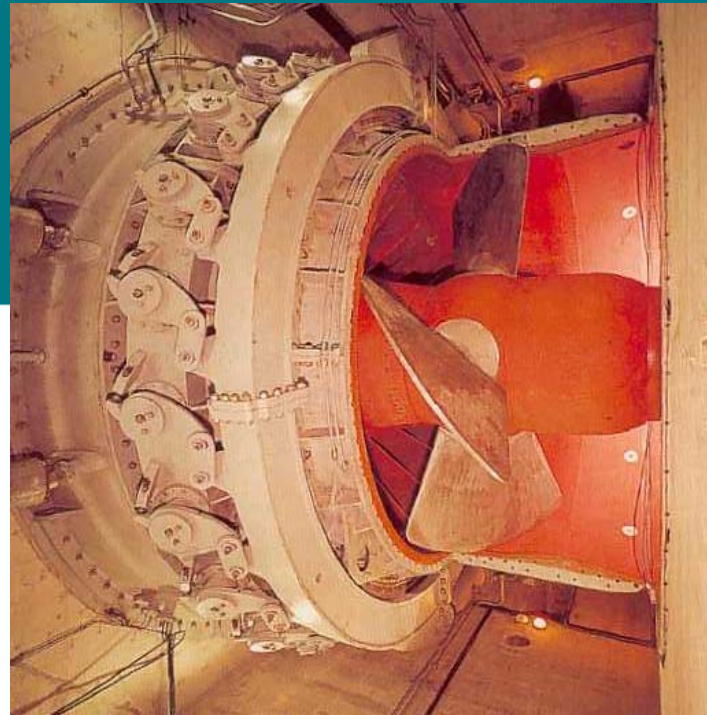



2.1 Bulb-turbine tests

In 1943, how to deal with the wide range of heads and flows ?

The flow range is 4,000 – 18,000 m³/s !

1943: First patent on an “upstream bulb turbine” (SEUM* & Neyrpic)

1951: First administrative file (with vertical classical low head turbines, the large diameter alternator being above the turbines and outside the water)

1953: Tests of “downstream bulb turbines” in Argentat and Cambeyrac EDF hydro power plants

1955-64: Two programmes of “upstream bulb turbine” tests (better ratio)

- One in Beaumont Montoux EDF hydro power plant (Alps-Isère), rated 8.8MW (commissioned in 1959) but running only as a turbine !
- One in an old lock in St Malo (rated 9MW), with La Rance characteristics, to confirm after many tests (double effect + pumping ; 1959-1964), the technical choices made

**SEUM: Société d’Etude pour l’Utilisation des Marées (Tidal Use Study Company) created in 1941*



2.2 Brief history of the bulb turbines construction

- 10 Jan. 1961: beginning of mechanical studies
 - 15 Sep. 1964: beginning of the assembly
 - 29 Jan. 1966: the 1st bulb-unit is achieved
 - 9 Mar. 1966: first “air” trial of this 1st bulb-unit
 - 14 Mar. 1966: the power plant is filled up with water
 - 19 Aug. 1966: hydraulic commissioning of the 1st bulb-unit and connected to the grid
 - **26 Nov. 1966: Official opening of the power plant**
 - 30 Nov. 1967: launching of the (last) 24th bulb-unit
 - 15 Dec. 1967 : simultaneous operation of the 24 bulb-units
- ➔ *After 40 years, on average, each of the 24 units had run 222,690 hours, with an immersed time of 324,494 hours and the cumulative gross output is about 21,600,000,000 kWh*

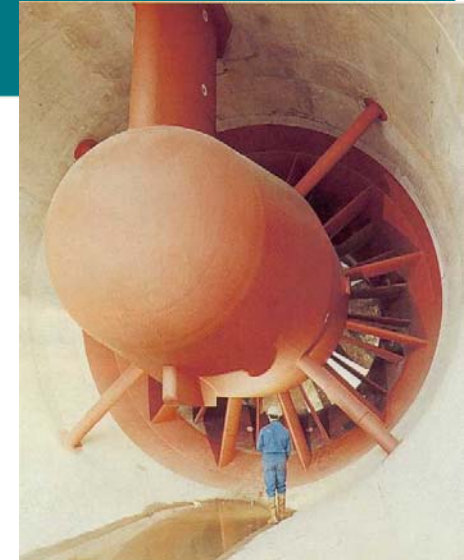



2.3 Main characteristics of La Rance bulb turbines

In Red : revolving parts

- Diameter: 5.35m
- Weight: 470t
- Rated head: 5.65m
- Discharge at rated head: 275m³/s
- Output: 10MW
- Rotation speed: 93.75rpm
- Max. overspeed: 260rpm
- 4 blades (inclination: -5° to +35°)
- 24 guide vanes
- Minimum head: 3m
- Maximum head: 11m

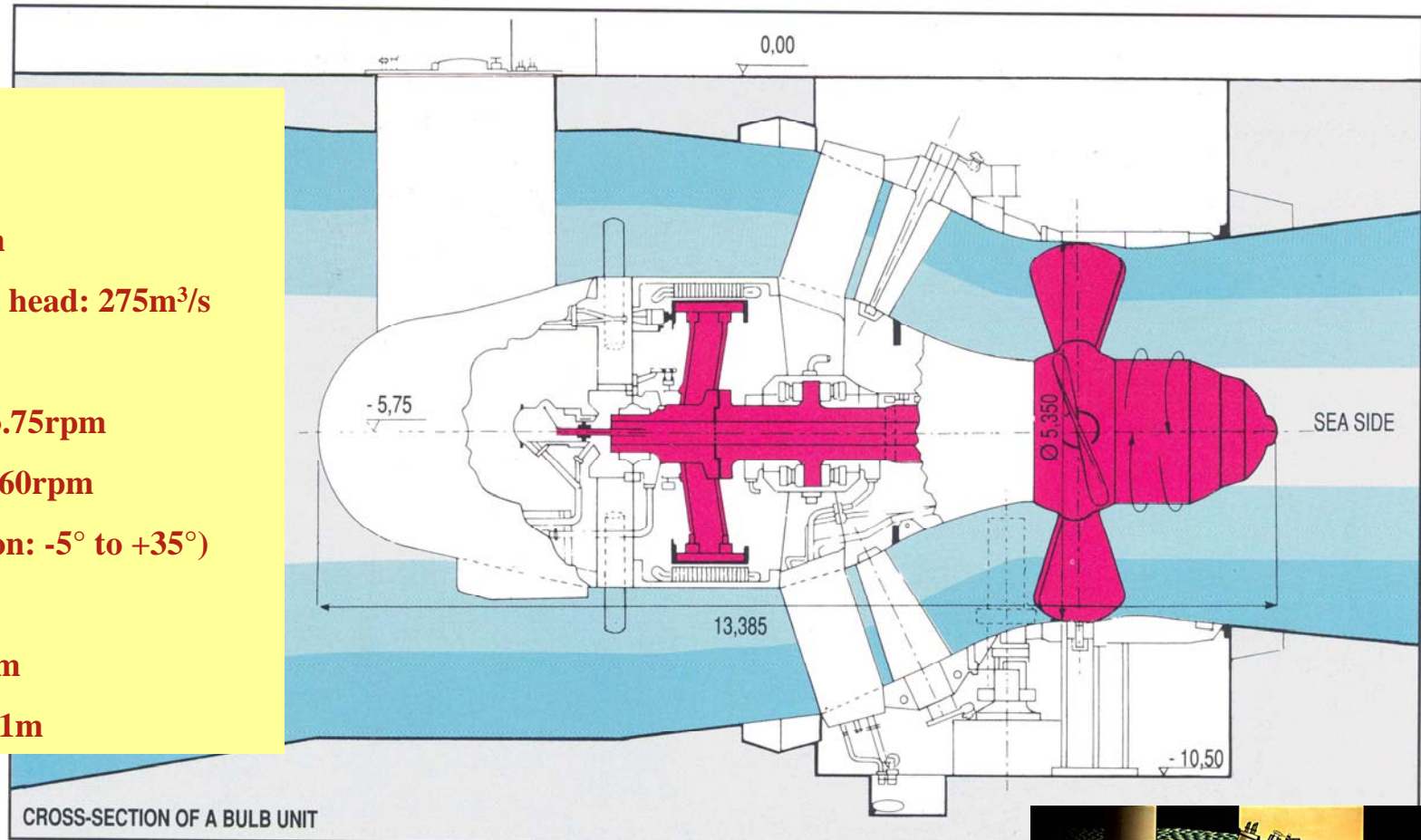

Cross-section of a bulb unit

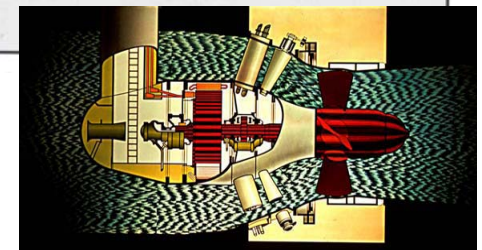

3

Sea Water: a corrosive environment

The cathodic protection

Imposed Current Cathodic Protection (I.C.C.P.)

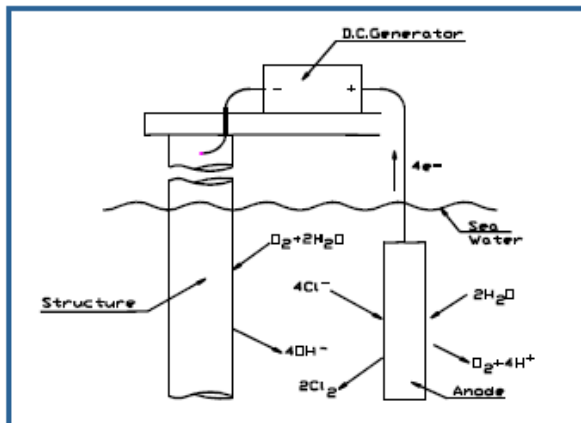

a successful story



3.1 Brief history of the studies

- **1955: creation of a “Corrosion Committee” within the SEUM**
 - Objectives of this Committee
 - Appreciate the metals behaviour
 - Provide advise on the paintings to use
 - Follow the tests on the St Malo bulb prototype, and
 - From these tests, provide recommendations for the 24 bulb-units
 - Main constraint: the operation requirements impede the use of coating
- **Tests and measures in laboratories and on models**
 - Potential difference generated by the association of various metals in marine water
 - Behaviour of stainless steels and cupro-aluminiums, according to the cathodic polarisation used
 - Optimal position of the anodes (solution: 40 anodes on the Neyrpic model)
- **Tests and measures on the bulb prototype in St Malo**
 - This prototype stayed 1 year without protection ⇒ severe corrosion on the defaults in the carbone-steel and localised corrosion in the stainless steel



3.2 Application to La Rance power plant

- After multiple tests on the experimental bulb-unit in St Malo, decisions:
 - Cathodic protection for the 24 turbines:
 - For each unit, 3 crowns of 12 anodes, representing 864 anodes in total
 - Installation of 4 electrodes of reference to check the potential of each unit, representing a total of 96 electrodes
 - A total of 18 “inverters” (24 V, 120 A)
 - Cathodic protection for the gates:
 - Until 1968: no cathodic protection for the gates
 - After 1968, according to the good results of cathodic protection on the units, each gate received 24 anodes, 12 electrodes, and 12 “inverters”
 - Cathodic protection for the metallic parts of the lock:
 - Before 1978, observation of numerous corrosion attacks
 - From 1978, 16 anodes, 4 electrodes, and 4 “inverters”
 - ⇒ No more steel corrosion since then (observation in 1985)
- Monitoring of the cathodic protection system
 - ⇒ 9500 measures per year (current, voltage, electro-chemical potential)
 - ⇒ Consequence in terms of total time for maintenance = 874h/yr

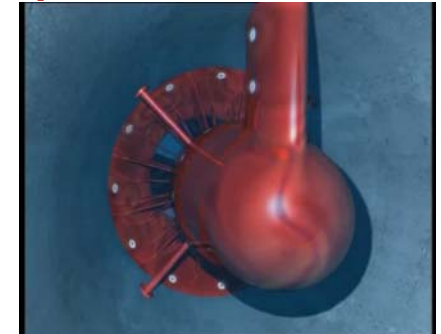



3.3 In 1967 and 40 years later...

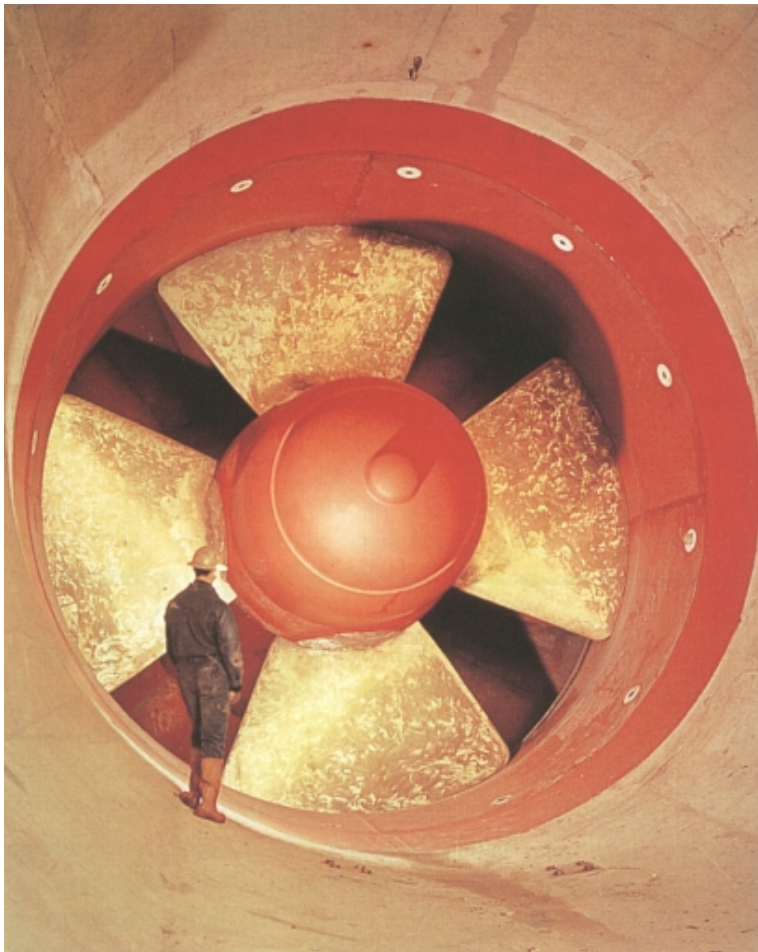

**12,000t of steel and almost no corrosion
and no more painting coat !**

4

The construction

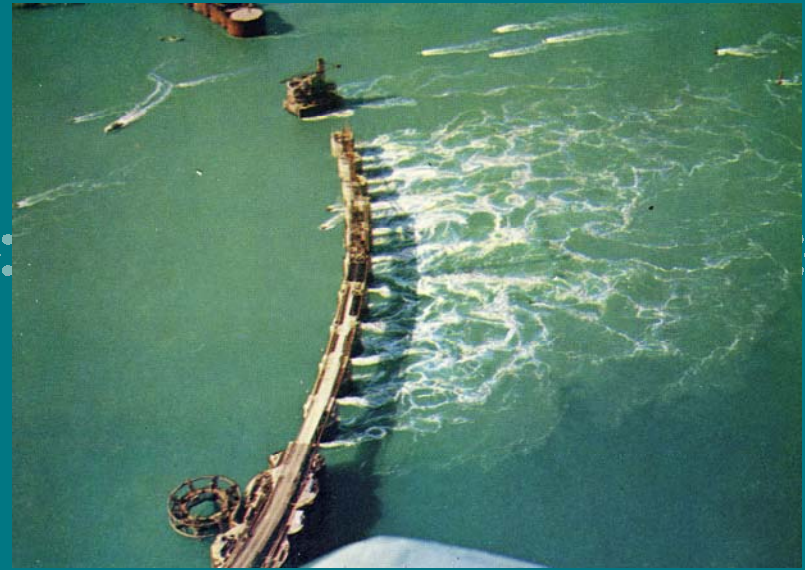

a true challenge !





4.1 Construction



- Technical choice: the structures are to be built in a dry enclosure within 3 cofferdams
- A construction in 3 phases:

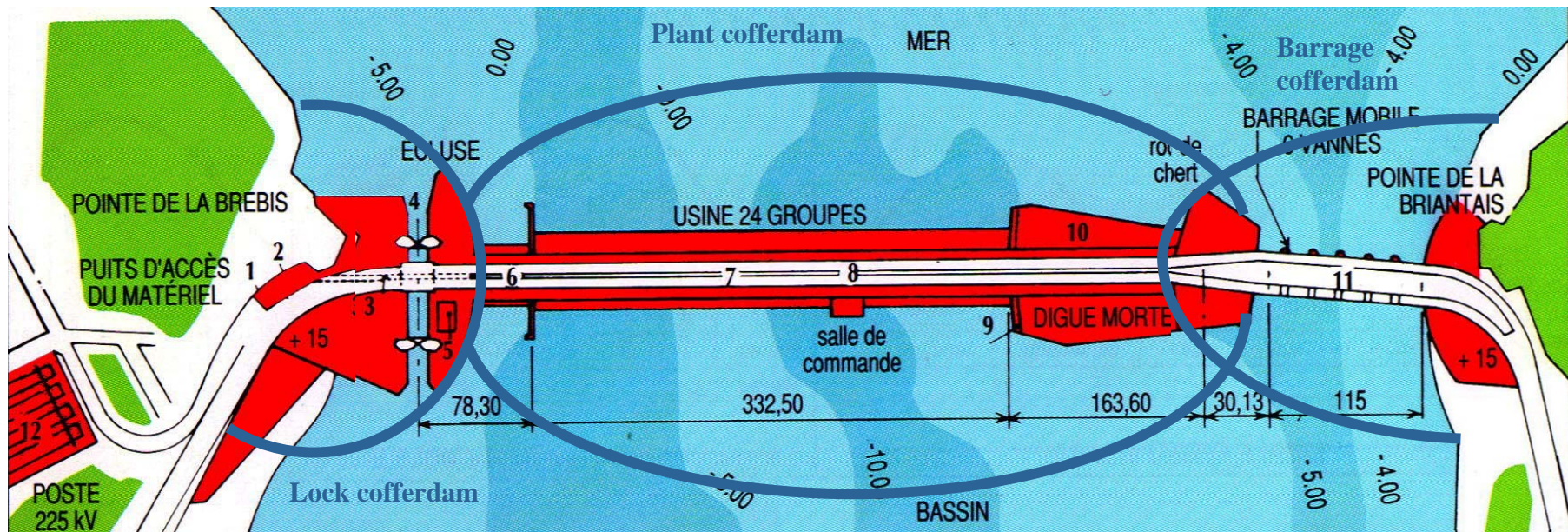

Cofferdams: 40,000m³ concrete + 13,000t sheet-piles + 460,000 m³ sand (ballast)

Barrage & plant: 400,000m³ excavation + 350,000m³ concrete + 15,000t steel + 350,000m² formwork



4.2 Construction phases

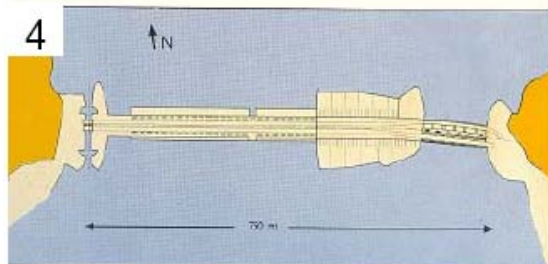
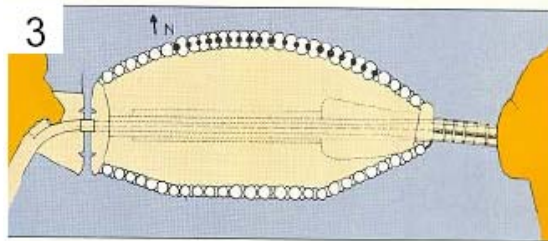
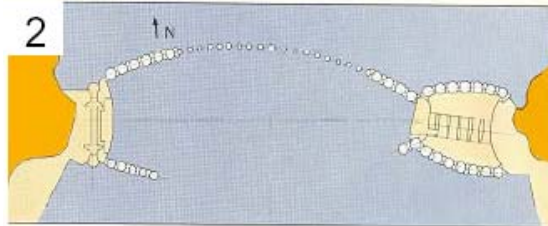
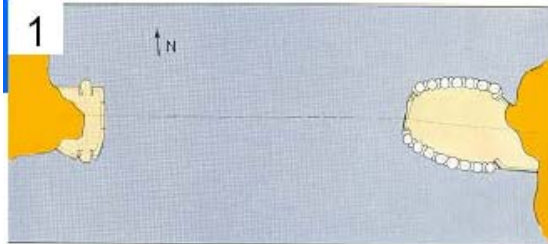

• 3 construction phases:

- Lock
- Barrage (sluiceway)
- Power plant + dyke

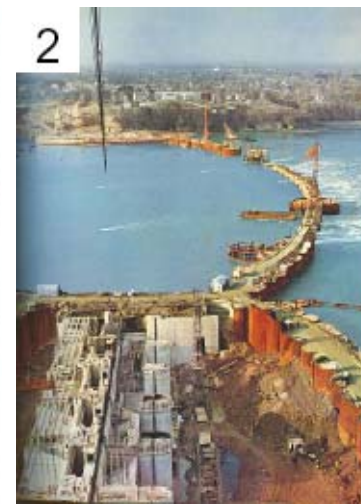



4.3 Innovation for the central cofferdam (caissons + sheet-piling gabions)

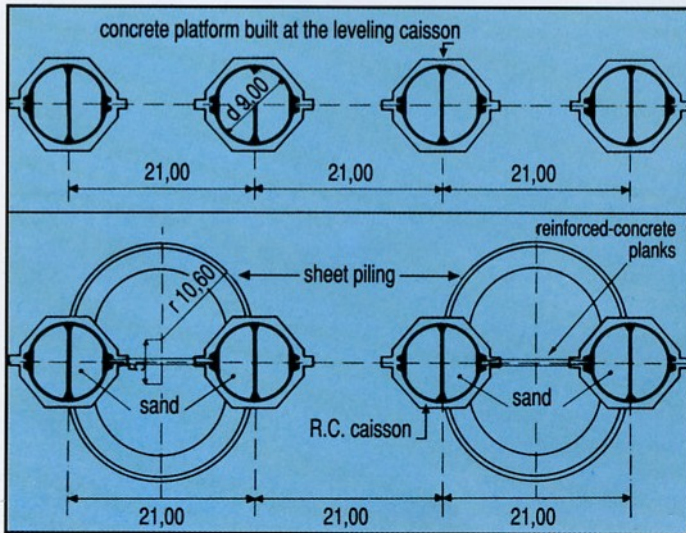
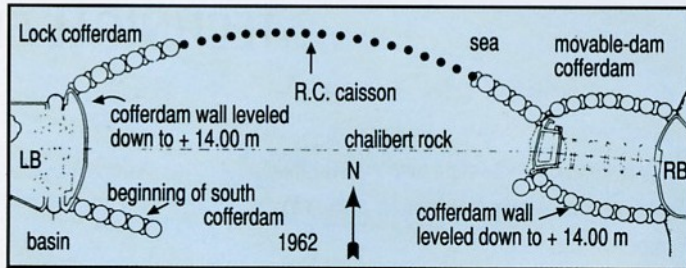

Main issue due to the high current velocity when cutting off the first cofferdam:

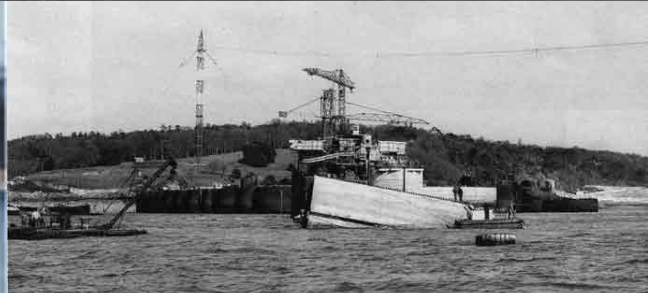



C - Maintenance

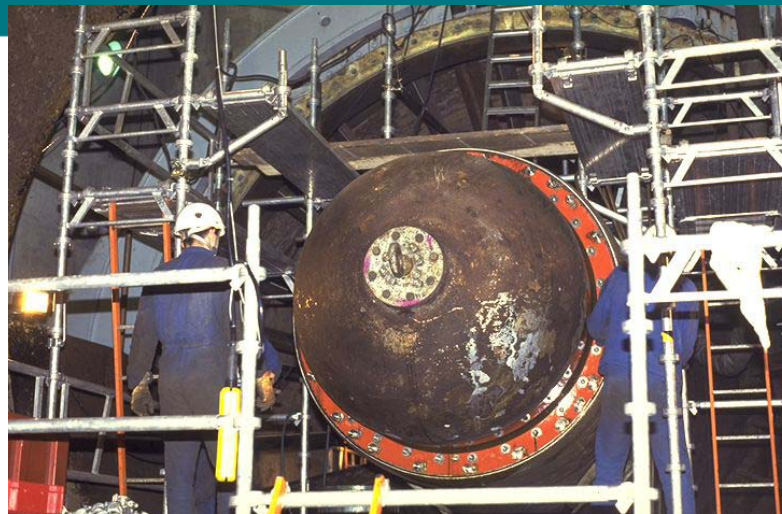



C - Main maintenance since the commissioning

- **STATORS** : due to problems with their magnetic components, stators had to be rebuilt (reduction in air gap between rotor and stator, mainly due to stresses linked to asynchronous startups for pumping + electrical spark erosion of rotor poles)
 - 1976: replacement of the first stator (Alsthom)
 - 1976 – 1982: replacement of all the stators (LK and Repelec)
 - 1995 – 1996: 7 stators have to be changed again (SARELEM)
- **BULB TURBINE RENOVATION** : after 30 years of satisfying operation, decision to globally and preventively check and maintain the 24 bulb-units
 - A 10 years maintenance programme (as decided in 1994) and a change in 1999

Year	...	1994	1995	1996	1997	1998	2000	2001	2002	2005	2006	...
Nb Units		1	1,1	1,3	1,9	2,7					1	
		Preventive maintenance					Curative maintenance					



C - Maintenance programme scheduled

- **2007 - 2009: replacement of the 12 circuit breakers, power cables and auxiliary transformer (PCB)**
- **2007 - : alternators maintenance according to the reduction of the « air gap »**
- **2009: refurbishment of the ship lock**
- **When needed: replacement of seals**
- **Later (within 10 years): replacement of the control process unit (installed in 1970)**





D - Environmental impacts





D - Aquatic environment

- Significant impact during the 3-year construction phases and closing of the estuary: disappearance of marine flora & fauna due to salinity fluctuations, heavy sedimentation and accumulation of organic matter in the basin
- By 1976, the Rance estuary was considered again as richly diversified: a new biological equilibrium was reached and aquatic life was flourishing again...
- By 1980, the basin was providing a habitat for 110 worm species, 47 crustacean species and 70 fish species. Enhancement of fish species and invertebrates abundance
- 2.5m rise of the mean level water and reduction of the hydrodynamic regime within the upstream estuary
- New fishery activities: scallops and now Belon oysters

Now, the basin = a small sea !





D - Impact on birds

- **Bird species variety is the same than before (120 species)**
- **A well developed communities of fish-eating birds (gulls, guillemots, shags...)**
- **Birds adaptation: decrease of sand area (intertidal area)**
- **Birds can also find food in the other Bays (mudflats)**





D - A « regular visitor »...

- Since 2000, a seal female has been living in the basin, passing through the sluice gates or even the lock
- Despite vain attempts to send her back to join seal communities, she always goes back to the Rance estuary!





D - Sediments – Experts disagree...

- Composition of La Rance estuary sediments is comparable with the neighbouring estuaries
- Increase in slack water exacerbates the natural tendency to seal off areas of high turbidity
- Hydrodynamical sediments deposit processes are similar to those of natural estuaries





D - Sediments – Experts disagree...

- **Modification of tidal stream in the estuary, in particular during ebb:**
 - Still areas: ↗ sedimentation
 - High current velocity areas: ↘ sedimentation
- **Rise in the average level of the basin:**
 - Decreasing tidal range
 - Less volume of sea water entering the estuary and less sediments
- **Slacks period are longer**
 - More silt deposit in the low intertidal zone

When comparing the Rance estuary with other regional estuaries, the sedimentation process is not considered as the highest !



E - Integration ?





E - Integration: a reality



- **Creation of the Comité Opérationnel des Elus et Usagers de la Rance (CŒUR; Operation Committee of Elected Representatives and Users of La Rance) in order to improve the quality of water, navigability...**
- **Improvement of the road connection between Dinard and St Malo: before 45km, now 15km (20,000 to 60,000 vehicules a day !)**
- **Tax revenues for collectivities: 2,200,000 €/year**
- **A tourist attraction: 70,000 visitors/year**
- **Part of the industrial inheritance**





La Rance was a first step...

- In the 70's La Rance scheme was considered as a first step for further French tidal range developments
- EDF carried out several feasibility studies...up to the 1980's (e.g. Albert Caquot's projects)
- But the nuclear development became EDF's priority...
- Nowadays, opportunity to resume tidal range studies in France... but few suitable estuaries (lagoons ?)

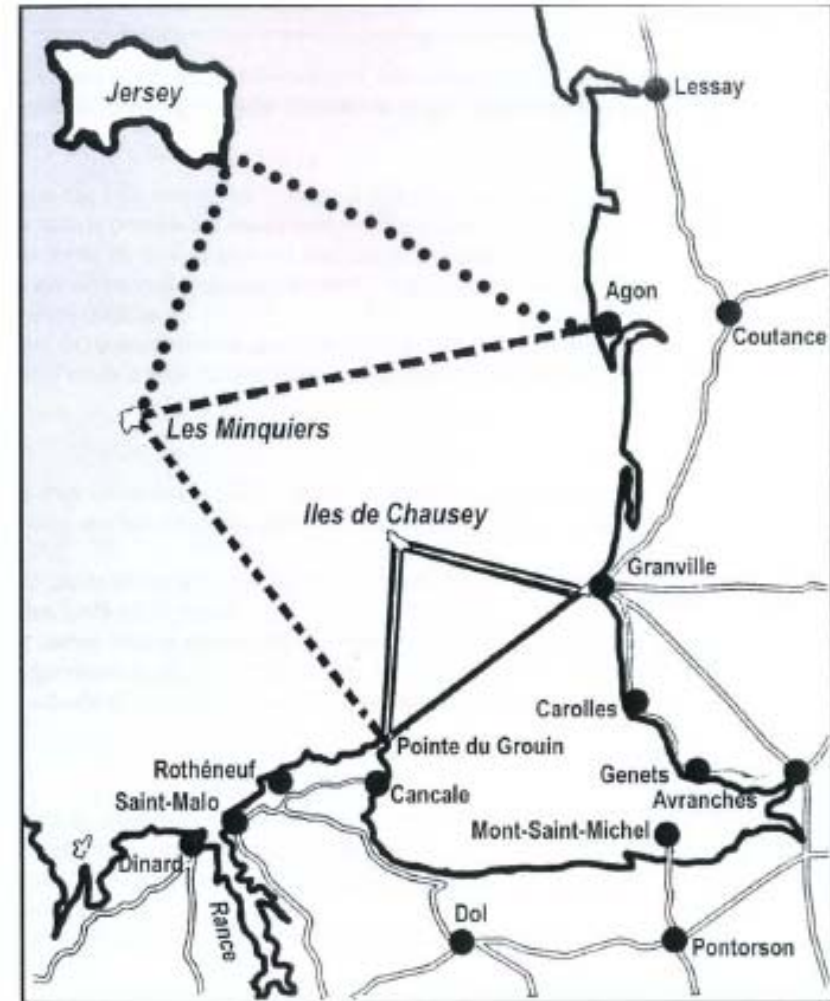



Conclusions

- Despite a lack of baseline environmental data before the construction, the 40-year of La Rance operation provide an inestimable feedback!
- La Rance is a technical success and despite the very severe operating conditions, the bulb turbines are still performing well
- The estuary again plays a nursery role for underwater creatures and remains a substantive home for birds
- Nevertheless, this new ecological balance is delicate and depends heavily on the regularity operation modes of the power plant (variation in water level)

