

# Effect of the Horns Rev 1 Offshore Wind Farm on Fish Communities

## Follow-up Seven Years after Construction

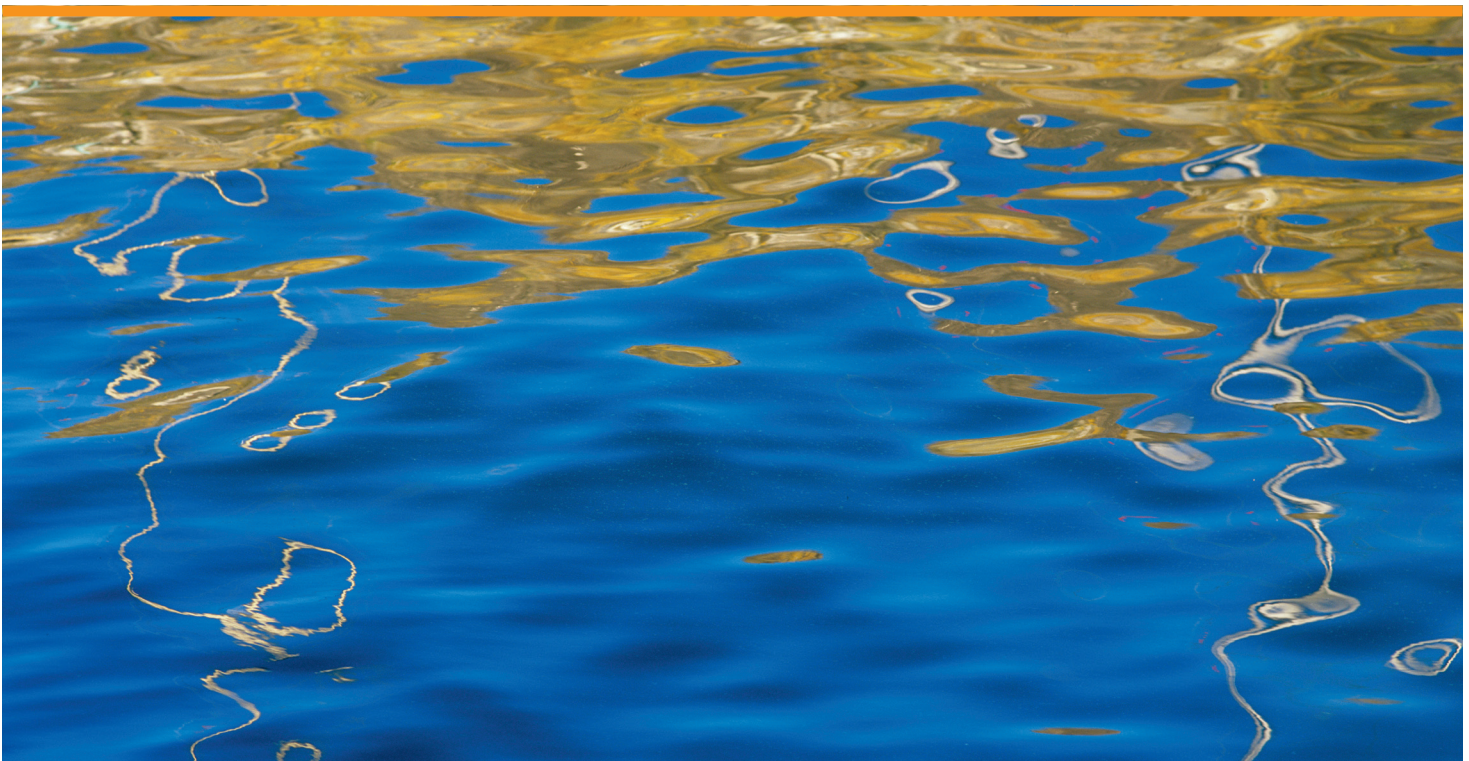

**DTU Aqua Report No 246-2011**  
By Simon B. Leonhard, Claus Stenberg  
and Josianne Støttrup (eds.)

# **Effect of the Horns Rev 1 Offshore Wind Farm on Fish Communities**

## **Follow-up Seven Years after Construction**

**DTU Aqua Report No 246-2011**

Editors:

Simon B. Leonhard, Orbicon A/S

Claus Stenberg and Josianne Støttrup, DTU Aqua

Authors:

Claus Stenberg, Michael van Deurs, Josianne Støttrup, Henrik Mosegaard, Thomas Grome, Grete Dinesen, Asbjørn Christensen, Henrik Jensen, Maria Kaspersen, Casper Willestofte Berg, Simon B. Leonhard, Henrik Skov, John Pedersen, Christian B. Hvidt and Maks Klastrup

## Contents

0	Summary .....	3
	Dansk resumé .....	5
1	Introduction .....	7
1.1	The Horns Rev 1 Offshore Wind Farm .....	8
1.2	Possible wind farm effects on fish communities .....	9
1.3	Possible effects on sand-dwelling sandeel assemblages .....	11
2	Methodology .....	13
2.1	Fish community. Used methodology .....	13
2.1.1	Fishing .....	13
2.1.2	Test fishing .....	15
2.1.3	Hydro acoustic surveys .....	16
2.1.4	Data analysis .....	17
2.2	Sandeel assemblages .....	19
2.2.1	Data analysis .....	21
2.2.2	Sediment .....	22
2.2.3	Simulation of larvae drift for <i>lesser sandeel</i> and <i>greater sandeel</i> .....	23
2.2.4	Species distribution modelling .....	23
3	Results .....	26
3.1	Fish community .....	26
3.1.1	Community structure .....	28
3.1.2	Abundance .....	30
3.1.3	Distribution in relation to distance from turbine foundations .....	38
3.2	Sandeel assemblages .....	39
3.2.1	Day and night patterns .....	41
3.2.2	Age .....	42
3.2.3	Drift-simulation of <i>greater sandeel</i> and <i>lesser sandeel</i> .....	44
3.2.4	Sediment quality .....	46
3.2.5	Species distribution modelling .....	47
3.2.6	Wind farm impact on the sandeel community .....	47
4	Discussion .....	49
4.1	Fish community .....	50
4.2	Sandeel assemblages .....	52
4.3	Cumulative effects .....	56
5	Conclusions .....	58
6	References .....	59

**Appendices**

Appendix I ..... 2  
Appendix II ..... 3  
Appendix III..... 4  
Appendix IV ..... 5  
Appendix V..... 9  
Appendix VI ..... 11  
Appendix VII ..... 14  
Appendix VIII..... 16  
Appendix IX ..... 21  
Appendix X..... 26

## 0 Summary

Deployment of offshore wind farms is rapidly expanding in Denmark and in the rest of Europe, due to a high demand, both economically and politically, for renewable energy. At present 12 offshore wind farms are in operation in Danish waters. Offshore wind farms are often placed in relatively shallow waters (<20 m) due to engineering and economic constraints. These shallow areas are often biologically highly productive and function as important nursery and feeding grounds for a number of fish species. The establishment of wind farms is hypothesized to positively impact fish abundance and fish community structures by increasing habitat heterogeneity and through exclusion of trawling activities within the wind farm area.

This report presents results from a field experiment in a demonstration study site (Horns Rev Offshore Wind Farm 1), one of the world's largest offshore wind farms. The construction of this farm, which is composed of 80 wind turbines and located in the North Sea 14-20 km off the western coast of Denmark, at Blaavands Huk, was completed in late 2002. The aim of the study was to analyze changes in fish community structure, spatial distribution and changes in sandeel assemblages due to the establishment of the wind farm.

The baseline study was conducted in September 2001 and March 2002 before the construction of the wind farm and the impact study was conducted 7 years later in September 2009 and March 2010 respectively. Surveys included multi-mesh gillnets targeting semi-pelagic and demersal (bottom-dwelling) species. Furthermore, the impact study included acoustic surveys along latitudinal and longitudinal transects targeting pelagic and demersal fish excluding sandeels, which were excluded from the acoustic analysis due to backscatter interferences with other low acoustic detectable organisms.

The introduction of hard substrate and higher complexity relative to the homogenous sand banks characteristic of the North Sea resulted in minor changes in the fish community and species diversity. Fish community changes were observed after the deployment of the wind farm due to changes in densities of the most commonly occurring fish, *whiting* (*Merlangius merlangus*) and *dab* (*Limanda limanda*), but reflected mostly the general trend of these fish populations in the North Sea. Due to significant temporal variation and patchiness in the distribution patterns of fish densities and biomass no general significant changes in the abundance or distribution patterns of pelagic and demersal fish were found in the acoustic surveys, neither between the control site and the wind farm site nor inside the impact area between foundations.

The introduction of hard bottom substrate resulted in higher species diversity close to each turbine with a clear spatial (horizontal) distribution, which where most pronounced in the autumn, where most species were registered. New reef habitat fish such as *goldsinny wrasse* (*Ctenolabrus rupestris*), *viviparous eelpout* (*Zoarces viviparous*) and *lumpsucker* (*Cyclopterus lumpus*) established themselves on the introduced reef area. Very few gobies were caught near or at the wind farm, and the near absence of these species was suggested to be related to the hydrographical conditions of the wind farm area and to have implications for the occurrence of pelagic and demersal species.

The fish communities in the Horns Reef area showed significant seasonal variation. Species richness and abundance was low in spring compared to autumn and especially the unusually cold winter 2009-2010 significantly affected the fish communities both in the wind farm area and in the control area. In general fish abundances and species richness seem to increase with increasing depth, increasing the significance of deployed turbine structures at greater depths as refuge areas for fish. Use of telemetrics in Dutch studies has shown a behavioural response where *cod* (*Gadus morhua*) move in and out amongst the hard structures of offshore wind farm foundations.

Horns Rev are a habitat to sandeels which are a highly abundant group of fish species that, due to its vast abundances and high oil content, plays an inevitable key role in the North Sea ecosystem and as a commercially viable species. Although pronounced seasonal and day/night (diurnal) effects on sandeel

catchability was found, the results revealed no indication that the construction of the Horns Rev I wind farm had a detrimental long-term effect on the overall occurrence of sandeels. However, a short-term effect was detected in March 2004, mainly due to a temporary increase in juveniles primarily of the *greater sandeel* (*Hyperoplus lanceolatus*), which completely dominated the sandeel community at the Horns Reef area.

Sandeels are closely associated to the fraction of fine pure sand in seabed sediments and only seabeds with fractions of finer particles of silt and clay below a critical limit of 2% provide suitable sandeel habitats. Although the highest value for the fine particle fraction was found in the control site, no significant changes in the seabed sediment composition was detected after the construction of the wind farm, except for 2004, where a higher fraction of gravel was found inside the wind farm area. The weight fraction of silt and clay in the sediment was generally below 1%. The present study indicates that wind farms represent neither a threat nor a direct benefit to sandeels in near-shore areas dominated by *greater sandeel*, although the recruitment of *greater sandeel*, which are self reproducing in the Horns Reef area, might benefit specifically from the exclusion of fisheries in the wind farm area.

Experiences from post construction studies concerning effects on fish communities from offshore wind farm development are rare or almost missing, why no attempt was made to involve an appropriate Population Viability Assessment (PVA) to appraise effects of increased suitable habitat for certain reef species or effects of exclusion of fisheries on sandeel populations. Cumulative effects of more wind farms in the area may be an increase in recruitment of reef habitat fishes and ecological rehabilitation of habitats due to the exclusion of fisheries in larger areas suitable for sandeels. The cumulative effect of introducing vertical structures in deeper waters may be an aggregation of larger gadoids in this area.



*Cod in the wind farm area at Horns Reef*

## Dansk resumé

På grund af stor efterspørgsel, både økonomisk og politisk, for vedvarende energi er udbygningen af havvindmølleparker hastigt voksende i Danmark og i resten af Europa. For nuværende er 12 havvindmølleparker i drift i de danske farvande. Havvindmølleparker er på grund af tekniske og økonomiske begrænsninger ofte placeret på relativt lavt vand - mindre end 20 m.

Lavvandede områder er ofte biologisk yderst produktive og fungerer som vigtige opvækst- og fourageringsområder for en række fiskearter. Det er ofte antaget, at etableringen af havmølleparker har en positiv indflydelse på fiskesamfundets størrelse og struktur ved at øge levestedernes mangfoldighed og ved udelukkelse af trawlfiskeri inden for selve mølleparken.

Denne rapport præsenterer resultaterne fra et undersøgelsesprogram udført i og omkring Horns Rev 1 havvindmøllepark, som er en af verdens største havvindmølleparker. Horns Rev 1 består af 80 vindmøller og er placeret i Nordsøen 14-20 km ud for Blåvands Huk, det vestligst punkt af Danmark. Mølleparken stod færdigopført i slutningen af 2002.

Formålet med undersøgelsen var at analysere ændringer i fiskesamfundets struktur og udbredelse samt analysere ændringer i tobis samfundet som følge af etableringen af mølleparken.

Forud for opførelsen af havvindmølleparken er der gennemført en baseline undersøgelse af fiskesamfundet i henholdsvis september 2001 og marts 2002, og effektundersøgelserne blev gennemført 7 år senere i september 2009 og marts 2010. Undersøgelserne omfattede anvendelse af biologiske undersøgelsesgarn med flere maskestørrelser, som er målrettede til undersøgelse af semi-pelagiske og bundlevende (demersale) arter. Effektundersøgelserne inkluderede endvidere akustiske undersøgelser ligeledes målrettet kortlægningen af pelagiske og bundlevende fisk langs både længdegående og tværgående transekter. Kortlægningen af *tobis* indgik ikke i undersøgelsen på grund af et artsspecifikt lavt ekkosignal og dermed interferens med andre organismer med lavt ekkosignal.

Indførelsen af hårde substrater og dermed større substrat kompleksitet i forhold til de homogene sandbanker, som er karakteristisk for Nordsøen, resulterede i mindre ændringer i fiskesamfundet og i artssammensætningen i området. Ændringerne i fiskesamfundet efter etableringen af havmølleparken skyldes primært ændringer i tæthederne af de mest almindeligt forekommende fisk, *hvilling* (*Merlangius merlangus*) og *ising* (*Limanda limanda*) som ligeledes afspejlede den generelle tendens i udviklingen af disse fiskebestande i Nordsøen. Ved de akustiske undersøgelser blev der ikke, på grund af en betydelig tidsmæssig variation og spredning i fordelingsmønstret og tætheden af fisk samt i biomassen, ikke fundet væsentlige ændringer i hverken det pelagiske samfund eller det bundlevende samfund mellem kontrolområdet og havvindmølleparken eller mellem selve møllefundamenterne.

Indførelsen af hårbunds substrat resulterede i en højere artsdiversitet tæt på hvert enkelt vindmøllefundament med en klar rumlig (vandret) fordeling, som var mest udtalt i efteråret, hvor de fleste arter blev registreret. Rev tilknyttede arter som *havkarusse* (*Ctenolabrus rupestris*), *ålekvabbe* (*Zoarces viviparous*) og *stenbider* (*Cyclopterus lumpus*) etablerede sig på det nye rev område. Meget få kutlinger blev fanget i nærheden af eller i selve mølleparken, hvilket antages at være relateret til de hydrografiske forhold i området. Den næsten manglende tilstedeværelse af disse arter blev ligeledes antaget at have indflydelse på forekomsten af de pelagiske og bundlevende arter.

Fiskesamfundet i Horns Rev området udviste signifikante sæsonmæssige variationer med lavt artsantal og lave individtætheder i foråret sammenlignet med efteråret. Især havde den usædvanligt kolde vinter 2009-2010 en væsentlig indvirkning på fiskesamfundet både i selve mølleparken og i kontrolområdet. Generelt synes fisketætheden og artsrigdommen at øges med stigende dybde, hvilket øger betydningen af udlagte møllefundamenter på større dybder som tilflugtssteder for fisk. Ved brug af telemetri i

hollandske undersøgelser er der påvist en adfærdsmæssig reaktion hos *torsk* (*Gadus morhua*), som i tilknytning til møllefundamentene bevæger sig ind og ud af mølleparken.

Horns Rev er levested for tobis, som er en meget udbredt og artsrig gruppe af fisk, der på grund af sine enorme tætheder og højt olieindhold, spiller en uvurderlig og central rolle i Nordsøens økosystem. Tobis er endvidere kommercielt vigtige fiskearter. Selvom tobis fangsterne var meget påvirket af en udtalt sæson-og dag/nat variation, viste resultaterne ingen tegn på, at opførelsen af havvindmølleparken på Horns Rev havde en negativ langtidseffekt på den samlede forekomst af tobis. Imidlertid blev der konstateret en kort-tids effekt i marts 2004, primært som følge af en temporær stigning i antallet af unge individer af primært *plettet tobiskonge* (*Hyperoplus lanceolatus*), der fuldstændig dominerede tobis samfundet i Horns Rev området.

Tobiser er tæt knyttet til en havbund af fint rent sand, og kun sedimenter med fraktioner af finere partikler af silt og ler, under en kritisk grænse på 2%, er passende tobis levesteder. Der blev ikke konstateret væsentlige ændringer i havbundens sediment sammensætning efter etableringen af mølleparken, med undtagelse af 2004, hvor andelen af grus var større i selve mølleparkområdet, selvom de højeste værdier for den fine partikel fraktion generelt blev fundet i sedimentet fra kontrolområdet. Fraktionen af silt og ler i sedimentet var generelt under 1%. Undersøgelserne har vist, at vindmølleparker ikke udgør en trussel ej heller en direkte fordel for tobis samfundet i kystnære områder domineret af *plettet tobiskonge*, skønt udelukkelsen af fiskeri i mølleområder kan gavne rekrutteringen af denne art.

Erfaringer fra undersøgelser af virkningerne på fiskesamfund som følge af udbygningen af havvindmølleparker er sjældne eller næsten manglende, hvorfor der ikke blev gjort forsøg på at inddrage et decideret Population Viability Assessment (PVA) i vurderingen af virkningerne på visse revtilknyttede arter som følge af en øget tilgængelighed af egnede levesteder eller effekter på bestanden af tobis som følge af udelukkelse af fiskeri. Kumulative effekter af flere vindmølleparker kan vise sig som en stigning i rekrutteringen af revtilknyttede arter og en økologisk genetablering af større og velegnede habitater for tobis som følge forbuddet mod fiskeri i områder med vindmølleparker. Den kumulative effekt af etableringen af vertikale strukturer på dybere vand kan vise sig ved en øget tæthed af større torskearter i området.



*Goldsinny wrasse at boulders at Horns Reef*



# 1 Introduction

The number of offshore wind farms is steadily increasing in Denmark and in the rest of Europe due to a high demand, both economically and politically, for renewable energy. Denmark plans to establish offshore wind farms with a total capacity of 4,400 MW (Energistyrelsen, 2011). The overall aim is that offshore wind will contribute as much as 50% of the total national consumption of electricity in 2025. A detailed Environmental Impact Assessment (EIA) is carried out for each wind farm to assess potential environmental impacts during construction and operation.

Offshore wind farms consist of multiple regularly positioned vertical piles of steel or concrete caissons extending from the sea bottom to above the water surface, at which the nacelles and blades are mounted. The base of each pile is surrounded by beds of boulders to prevent seabed erosion. Abundant documentation of the artificial reef effect of sunken vessels and other man-made hard structures is available demonstrating increase in local species diversity and biomass production (Davis, *et al.*, 1982; Ambrose, *et al.*, 1990; Coleman and Connell, 2001; Gray, 2006; Wilhelmsson, *et al.*, 2006; Arena, *et al.*, 2007; Martin and Lowe, 2010). Present and planned wind farms in the North Sea are located on sandy bottoms that are inhabited by a species community very different from that of boulder reefs. According to (Jensen, 2002) it takes around five years before stable communities are established after deployment of artificial hard structures. A full understanding of the potential ecological consequences of deploying offshore wind farms therefore requires knowledge of not only the artificial reef effect but also on ecosystem effects at species, population, habitat and community level, at appropriate temporal scales (Davis, *et al.*, 1982; Ambrose, *et al.*, 1990).

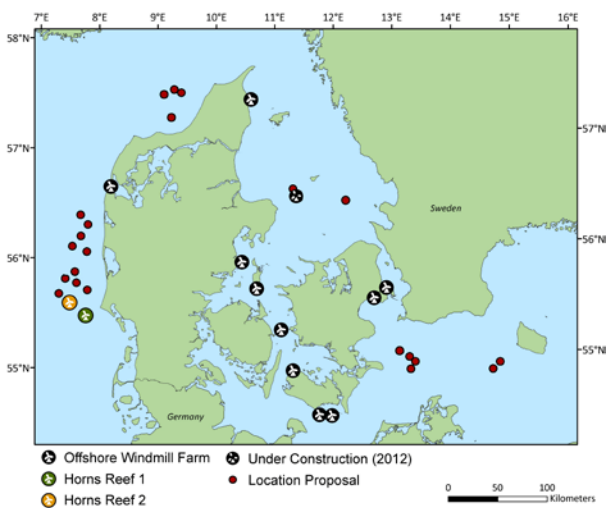

Figure 1. Locations for offshore wind farms in Denmark. Proposed locations for future offshore wind farms are continuously adjusted and latest updated in 2011 (Energistyrelsen, 2011).

The 12 offshore wind farms presently in operation in Denmark and the one under construction at Anholt, are placed in relatively shallow waters at less than 20 m depth, due to engineering and economic constraints (Figure 1). These shallow areas are generally highly biologically productive and act as important nursery and/or feeding grounds for a number of fish species. In the Horns reef area, the hard structures introduced, such as turbine foundations and scour protections, provided habitats for species other than those normally associated with the sandy seabed resulting in an increase in faunal biomass and potential food availability (Leonhard and Pedersen, 2006). These new habitats and increase in food may well over time attract higher numbers and a wider range of species of fish and may increase production and recruitment of resident species.

Since 1999 several environmental investigations have been carried out in the Horns Reef area with the objectives to document changes in habitat structure and in flora and fauna communities due to the establishment and operation of one of the world's largest offshore wind farms - Horns Rev I constructed in 2002. The results and experiences from the environmental investigations on effects from this demonstration wind farm and the other demonstration wind farm in Denmark - Nysted Offshore Wind Farm constructed in 2002/2003 and located in the Baltic - are summarised in a publication "Danish Offshore Wind - Key Environmental Issues" issued by DONG Energy, Vattenfall, The Danish Energy Authority and The Danish Nature Agency addressing the need for further research on e.g. the development in fish communities at marine wind farms (DONG, *et al.*, 2006).

The results on Horns Rev I indicated that during the first three years after construction, fish species increased in numbers in the impact area. Results from other post-construction studies after establishment of an offshore wind farm in the Dutch coastal zone have shown high spatial and temporal dynamics in the fish communities and only minor effects upon the fish assemblages near the turbine foundations although, some fish species such as cod, seem to find shelter inside the wind farm (Winter, *et al.*, 2010; Lindeboom, *et al.*, 2011).



Figure 2. Birds view of the Horns Rev 1 Offshore Wind Farm seen from south east.

The present study, focusing on the fish community at the Horns Rev 1 Offshore Wind Farm is part of The Environmental Monitoring Programme for the Danish offshore demonstration wind farms Horns Rev 1 and Nysted, administered by The Environmental Group consisting of The Danish Energy Agency, The Danish Nature Agency, Vattenfall

and DONG Energy. The work was conducted under contract with Vattenfall Vindkraft A/S, and sponsored by the Danish energy consumers through a public service obligation.

The objective of the present study was to document possible refuge effects or changes in local fish communities seven years after the establishment of the wind farm at a time where wind farm effects on the physical and biological environment could be assumed to have stabilised.

Fish communities and sandeel assemblages were compared inside and outside the wind farm area, with the null-hypothesis that the introduction of an offshore wind farm does not affect species composition, temporal or spatial distribution of species or relative abundance.

### 1.1 THE HORNS REV 1 OFFSHORE WIND FARM

The Horns Rev 1 Offshore Wind Farm (Figure 2), is located in the North Sea 14-20 km off the western coast of Denmark, at Blaavands Huk and the construction was completed in late 2002.



Horns Rev 1 Offshore Wind Farm

The wind farm has a capacity of 160 MW and is composed of 80 wind turbines (Vestas V80- 2MW) erected in a grid pattern of 10 rows oriented north-south. The distance between the individual wind turbines and rows is 560 m and the wind farm covers an area of 27.5 km<sup>2</sup> including a 200 m buffer zone around the wind farm.

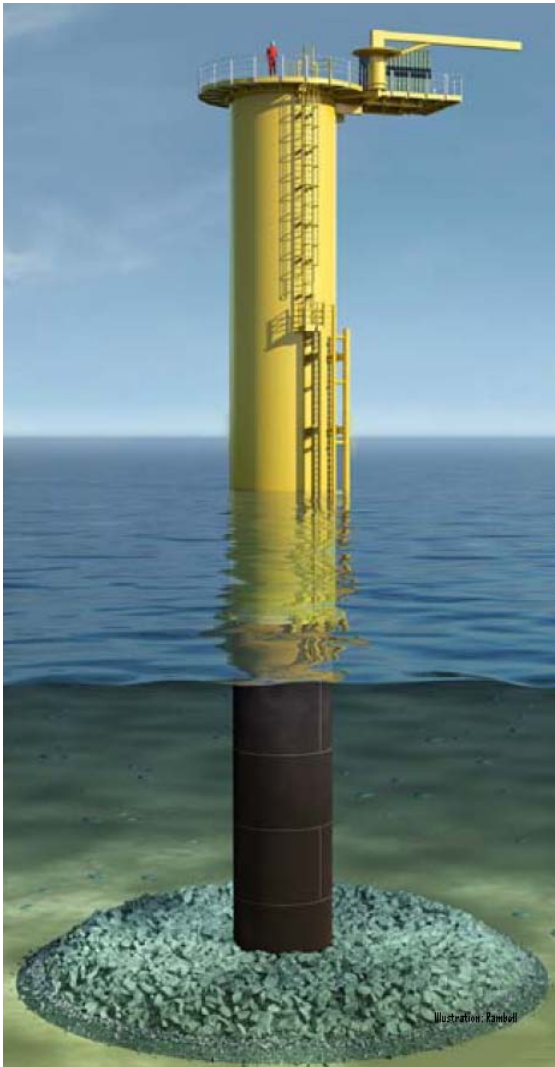

Figure 3. Wind turbine dimensions for turbines placed at Horns Rev. Monopile and a transition piece reach a height of 9 m above the sea surface.

The wind turbine foundations are constructed using the “monopile” concept. The monopile foundation at Horns Rev is in principle a steel pile of 4 m in diameter that is rammed approximately 25 m into the seabed (Figure 3).

The scour protection around each monopile in the wind farm, deployed to protect the foundation from erosion, is approximately 25 m in total width and approximately 1.3 m in height above the original seabed. Although great variability in width and form exist between individual scour protections, the general construction is composed of a protective stone mattress, approximately 0.8 m in thickness with large stones up to 55 cm in diameter overlaying a 0.5 m high gravel mattress consisting of smaller stones, 3-20 cm in diameter (Figure 5).

The turbine foundations including the scour protection cover approximately 39,300 m<sup>2</sup> of the seabed, which equals 0.14% of the total area of the wind farm.

The environment on Horns Rev is highly dynamic and influenced by winds, waves and tidal amplitude. Winds at Horns Rev are often strong and above 8 m s<sup>-1</sup> about 50% of the time (Figure 4a). Due to its easterly position in The North Sea waves generated from the prominent westerly winds can reach a wave height up to 3.7 m (maximum wave height 5.8 m in 2009 measurements) (Figure 4b). Due to the relatively shallow depth at Horns Rev larger waves break and can create violent surf. The tidal amplitude is up to 1.8 m and creates a strong tidal current in the area.

## 1.2 POSSIBLE WIND FARM EFFECTS ON FISH COMMUNITIES

The deployment of wind farms causes changes in substrate structure and texture, emergence of shadows and changed hydrographical conditions (Brostrom, 2008). Although only minor changes in local current patterns were expected based on hydrographical modelling (Elsamprojekt, 2000), these changes may affect the seabed structure and bottom living fish (demersal) communities. The modelled reduction in current speed within a distance of 5 m from the foundations is however less than 15% and the reduction in wave height in lee of the wind farm potentially affecting the seabed structure is less than 3.5% (Elsamprojekt, 2000).

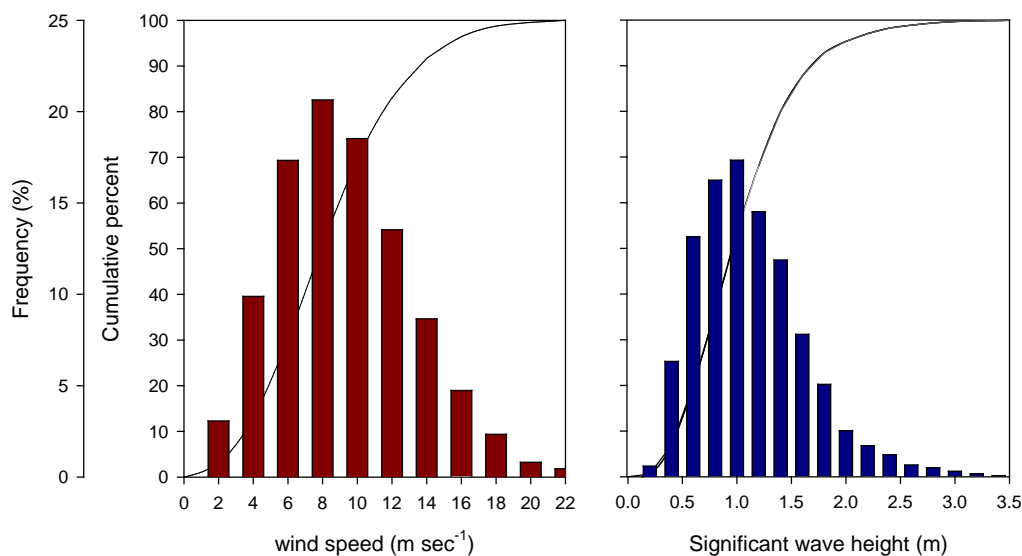

Figure 4. Wind (a) and wave (b) measurements from Horn Reef (redrawn from (Stenberg, *et al.*, 2010)).

In a shallow sandy area as Horns Rev, new habitat opportunities are created for fish and sessile organisms that may influence both fish and benthic communities and possibly their feeding habits or food relationship of the different organisms in the food chain (Wilhelmsson, *et al.*, 2006; Anderson and Öhman, 2010). Turbine foundations seem to be particularly favourable for blue mussels increasing their biomass significantly compared to natural mussel beds in Danish offshore wind farm areas (Maar, *et al.*, 2009). However, only few studies have quantitatively documented how marine fish are affected by such structures and studies have not provided conclusive evidence of enhancement of local fish populations as an effect of man-made constructions (Brickhill, *et al.*, 2005). Fish attraction to underwater constructions has been reported for different species of gobies (Wilhelmsson, *et al.*, 2006; Anderson and Öhman, 2010). Migratory round fish species such as cod and whiting are also attracted to underwater structures, seeking these out for refuge or shelter from currents or for foraging on the fauna developed on the bottom structures (Leitao, *et al.*, 2008; Fernandez, *et al.*, 2008; Page, *et al.*, 2007). However, to enhance a local population it is not sufficient for fish to be attracted to the structure as this may represent a simple redistribution of fish to a more confined area (Bohnsack, 1989).

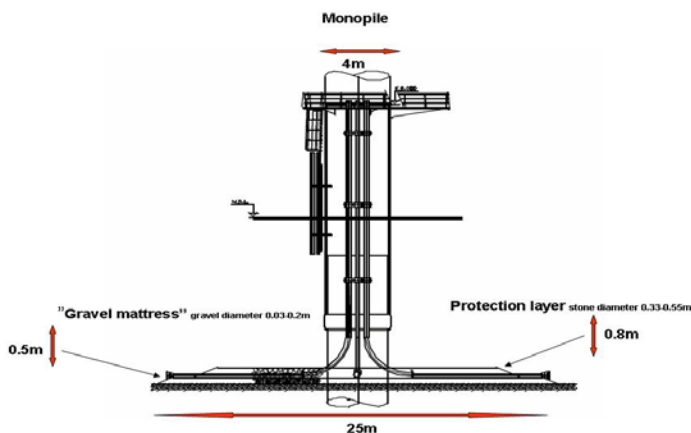

Figure 5. Wind turbine foundation and scour protection.

Increased production implies an increase in the carrying capacity of the area (Bohnsack, 1989). This includes increased feeding or shelter opportunities resulting in higher numbers recruiting to the adult populations. The rocky scouring around each wind turbine in the farm increased hard bottom substrate for sessile organisms and plants (Leonhard and Pedersen, 2006) and these together with rock crevices may provide refuge to fish of different sizes. The size and complexity of the structure is an important feature for regulating fish living close to or on the seabed

(demersal species) as it has been shown for both tropical coral reef fishes (e.g. Almany, 2004; Cappo, *et*

*al.*, 2007) and temperate reef fishes (Anderson and Miller, 2004). Likewise, habitat heterogeneity was shown to be important for the abundance and diversity of fish (Chabanet, *et al.*, 1997). Thus, structural diversity in an otherwise homogenous habitat feature can have positive effects on fish species diversity (Langhammer and Wilhelmsson, 2009).

Once in service the main purpose of an offshore wind farm is to generate energy which may also affect fish communities. Noise and vibrations from rotor blades and generators are transmitted through air and the monopole to the underwater environment (Nedwell and Howell, 2004). From the turbine generators energy is transported to end users at land. For this energy transmission each turbine is connected in a grid pattern to a transformer substation by sub-sea power cables buried in the seabed. Energy transmission through cables generates an electromagnetic field surrounding the cables. Differences in the electromagnetic fields, and thereby the possible effects on fish, between the cables in the grid net and the transmission cable to land exists due to differences in voltage levels transmitted. Although weak and only detectable at short distances from the cables, many fish species are able to sense these electromagnetic fields (Gill, *et al.*, 2005) and may be affected although it is unclear to what extent these disturbances negatively impact fish communities (Brostrom, 2008) and only effects from transmission power cables, due to high voltage transmission has so far been considered.

Exclusion of fishing, especially trawling, at wind farm sites may also affect fish communities. Around sub-sea power cables a Danish Executive Order on cabling provide a 200 m protective zone against bottom-trawl fishing and raw material extraction, which in general excludes these activities within a wind farm area and wind farm areas might function, temporarily or permanently, as a refuge for different fish species altering the species composition and abundance relative to an area outside the wind farm area.

The deployment of Horns Rev wind farm introduced new habitat in terms of substrate type, complexity and vertical relief relative to the original habitat of a bare sand bottom. It was thus expected that that local fish assemblages would be impacted, partly through attraction and partly through increased production through increased local carrying capacity; but also disturbances from other sources might affect the fish communities.

### 1.3 POSSIBLE EFFECTS ON SAND-DWELLING SANDEEL ASSEMBLAGES

Possible changes in seabed structure may affect sand-dwelling species like the sandeels. Sandeels are a highly abundant group of small eel shaped fish that due to its vast abundances and high oil content plays an inevitable key role in ecosystems (Robards, *et al.*; Furness, 2002; Frederiksen, *et al.*, 2005; Wanless, *et al.*, 2005; Anderson and Öhman, 2010). Sandeels are of high importance for the fishing industry in the North Sea inclusive the Horns Reef area (Krog, 1993). Sandeels are associated to sandbank areas, where they, due to their seasonal and diurnal feeding cycle, remain buried in the seabed during winter and night.

Sandeels are adapted to specific seabed conditions and display restricted tolerance to sediment textures. Sandeels live in well-oxygenated medium coarse sand with grain sizes between 0.25-1.2 mm and avoid both coarser and finer sediments. Furthermore, different species of sandeels display restricted dispersion and recruitment patterns (Ambrose and Anderson, 1990). Recently sandeels have been suggested as candidate indicators of the health of the North Sea Ecosystem, as the presence of sandeels may indicate the presence of other species (Rogers, *et al.*, 2010).

Four species of sandeel are found in the North Sea and in the Horns Reef area. The most abundant species of sandeel in the North Sea is the *lesser sandeel* (*Ammodytes marinus*) and the three other species are *small sandeel* (*Ammodytes tobianus*), *greater sandeel* (*Hyperoplus lanceolatus*) and the rare *smooth sandeel* (*Gymnammodytes semisquamatus*).

Sandeel behaviour, and its relevance for the health of the North Sea ecosystem, viewed within the context of an increasing number of wind farms in the North Sea, emphasizes the importance of clarifying the effects on local assemblages of sandeel from construction and operation of offshore wind farms established in sandbank areas.

The sandeels are mostly stationary, restricted to areas of suitable habitats, which is why recruitment success and sustainable development of the sandeel community is dependent on the number of larvae drifting in or out of the area and the success of metamorphosis of the larvae in the area of concern. Sandeels deposit slightly club-shaped eggs on sand grains. The eggs hatch on the seabed (Popp, 1994; Whitehead, *et al.*, 1986). Once the eggs have hatched and the yolk has been depleted, the larvae will have reached a length of 4-5 mm. Sandeels then enter into a pelagic stage where they feed upon zooplankton (Reay, 1970). In the pelagic stage, larvae are forced to drift with ocean currents. Within this context, it is unclear how recruitment is controlled and which mechanisms are vital for sandeel species to return annually to the same fishing grounds. There are signs that in the northern Skagerrak, higher concentrations of sandeels are found in the years when there have been strong northern currents, which transport larvae to the north from the southern North Sea (Popp, 1994). Studies conducted near the Shetland Islands show that sandeel stocks east of the islands largely recruited from populations around the Orkney Islands, where a strong east wind causes the larvae to be carried into the North Sea due to ocean currents (Proctor, *et al.*, 1998). After metamorphosis, by which time the larvae has reached a size of c. 4 to 5 cm, they shift from the pelagic stage, by leaving the main body of open water, and venture downwards to the sediment where they then spend most of the time buried in the seabed (Reay, 1970). Here, labelling experiments revealed that sandeel species remain in the same local area during their whole life (Kunzlik, *et al.*, 1986).



Sandeels

## 2 Methodology

The methodological approach adheres – where possible – to the “Before After control Impact” (BACI) design (Smith, *et al.*, 1993). BACI design describes an experimental approach and analytical method to trace environmental effects from substantial man-made changes to the environment. The aim of the method is to estimate the state of the environment before and after (BA) any change and further to compare changes at reference sites (or control sites) with the actual area of impact (wind farm area) (CI).

The strength or reliability of the results is tested by use of power analysis, testing the possibilities for both type 1 error, the error of rejecting the null hypothesis, when it is actually true, and type 2 error, the error of failing to reject the null hypothesis, when in fact it should have been rejected.

### 2.1 FISH COMMUNITY. USED METHODOLOGY

Surveys were conducted just before construction of the wind farm, which was initiated in 2002 and again eight years later. In between these investigations test fishing was conducted and observations of fish species were made as a supplement to the monitoring of faunal assemblages on the introduced turbine structures from 2003 to 2005 (Leonhard and Pedersen, 2006). To provide data on fish communities and distribution patterns gillnet and acoustic applications were combined.

#### 2.1.1 Fishing

The surveys before and after the wind farm deployment were carried out during September (autumn survey) and March (spring survey) (Table 1) within the impact and in a control area outside the wind farm (Figure 6).



Table 1. Successful gillnets stations in areas and by survey. At each station gillnets were set at three different distances (0, 120 and 230 m) to the turbine and with a replicate of two settings (north and south of the turbine). Position indicate the central sampling point for the location. The specific positions is shown in Figure 6.

Area	Location	Coordinates		Survey			
				24 Sep -7 Oct 2001	12-19 Mar 2002	11-18 Sept 2009	8-16 Mar 2010
				<i>Valid gillnet stations</i>			
Impact	55	N55 29.022	E7 50.737	4	4	5	4
	58	N55 28.121	E7 50.958	4	4	4	4
	95	N55 29.038	E7 52.858	3	4	4	4
Control	1	N55 31.755	E7 43.221	3	4	5	4
<b>Sum</b>				14	16	18	16

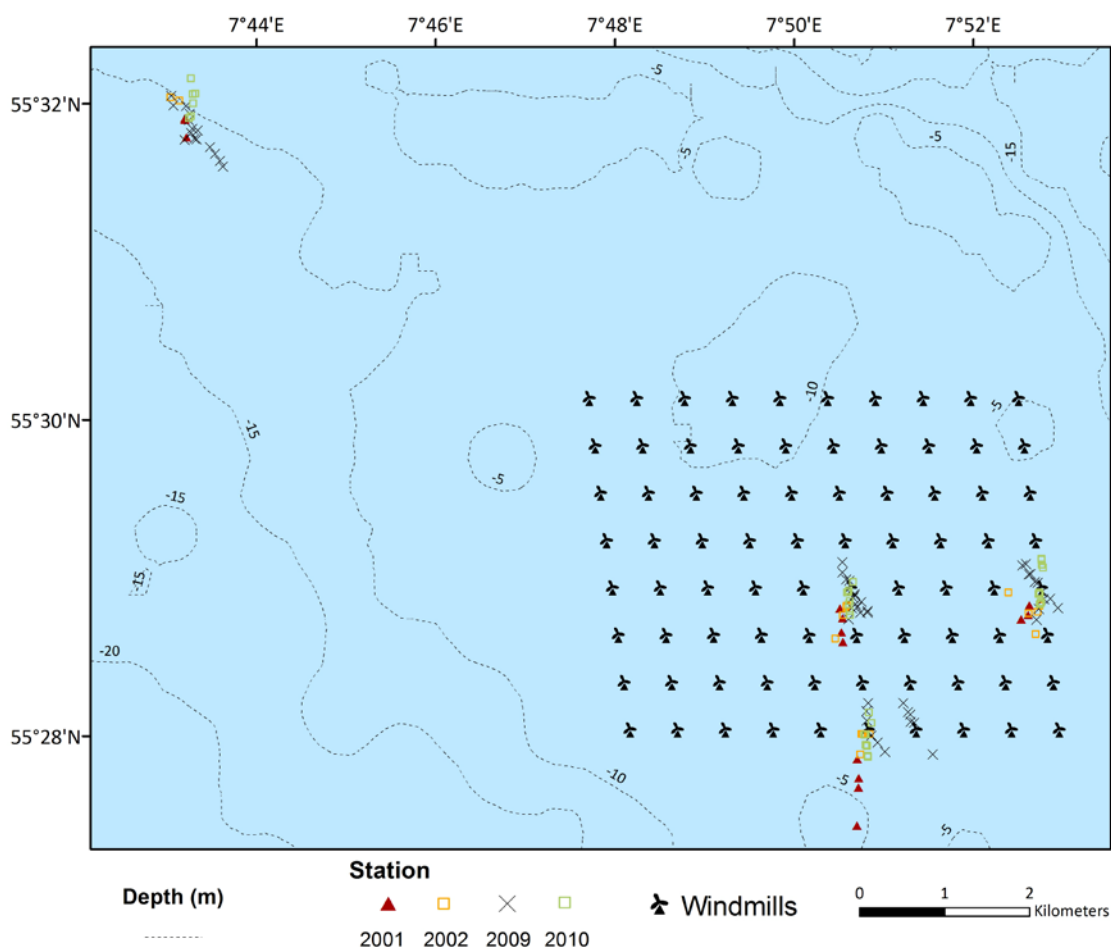

Figure 6. Map of sampling locations in the Horns Rev I area with indication of stations 55, 58, 95 in the park (impact) area. Different survey years shown by coloured symbols. Station in Control area located NW of impact area.

Fishery was conducted with multi-mesh gillnets and identical methodology and sampling effort was used in the before and after surveys. This gillnet was developed towards catching all sizes and types of marine fish in a coastal environment (Eigaard et al., 2000). Each gillnet consists of 12 gillnet panels of different mesh size (Table 2). There is a size discrepancy between some of the mesh sizes in the different panels but all were less than 5% and therefore assumed not to have any significant effect on size selection. Each panel was mounted on a buoyancy line and lead line, with a hanging ratio of 0.3.



The panels were randomly distributed and with a 1 m space between each panel to avoid the lead effect. The net is 1.5 m in height and 110 m in total length. In the “before surveys” all panels had a length of 6 m while in the “after surveys” panels were between 3 to 12 m. Reported catch numbers from all surveys was standardized to 6 m net panels.

Table 2. Specification of the multi-mesh gillnet used in the surveys before (years 2001/2002) and after (years 2009/2010). Mesh size is measured as knot to knot distance.

Mesh number	Meshsize (mm)		Length (m)	
	Before	After	Before	After
1	6.5	6.5	6	3
2	8.5	8.5	6	3
3	11.0	11.0	6	3
4	14.3	15.0	6	6
5	18.6	18.5	6	6
6	24.2	25.0	6	6
7	31.4	30.0	6	6
8	40.9	40.0	6	6
9	53.1	55.0	6	12
10	69.0	70.0	6	12
11	89.8	90.0	6	12
12	116.7	110.0	6	12

Three stations were placed in the impact area at wind turbines 55, 58 and 95 and one station in the control area NW of the wind farm (Table 1). At a given station gillnets was set at three increasing distances North and South from the wind turbine foundation –near; close to or in part on the scour protection (0 m), mid (120 m) and far (230 m). Gillnets were deployed late in the afternoon and retrieved after approx. h. Each station thus had a total of 6 gillnet settings.

Fish catch was identified to lowest possible taxonomic level, length measures to total length. In this study sandeels were only determined to family level (*Ammodytidae*). Fish species were grouped according to their ecological habitat.

Supplementary to gillnet and acoustic surveys one trawl haul was performed in both the impact and the control site using TW3 semipelagic trawl.

### 2.1.2 Test fishing

A test fishing using multi-mesh gillnets was performed each year in spring and autumn from 2003 until 2005 at wind turbine 54 or 33 (Table 3) and visual observations of fish species were made by SCUBA divers (Leonhard and Pedersen, 2006). In March 2003 and 2004 and in September 2003 the test fishing was performed at turbine site 54, whereas from September 2004 until September 2005, turbine site 33, situated in a deeper part of the impact, was selected based on the observations of the divers detecting more species in this area than in any other site investigated. Both pelagic gillnets and sinking gillnets reduced in length (42 m) were used during day and night.

Table 3. Test fishing locations.

Location	Coordinates	Depth (m)
33	N55 29.602 E7 49.523	11
54	N55 29.314 E7 50.665	10

The nets were placed with the southern end close to the monopile in the direction of the main current towards 20° NNE. The pelagic nets were placed in the pelagic zone approximately 1.5-2.5 m above the seabed covering both

the scour protection and the seabed outside the scour protection (Figure 7).

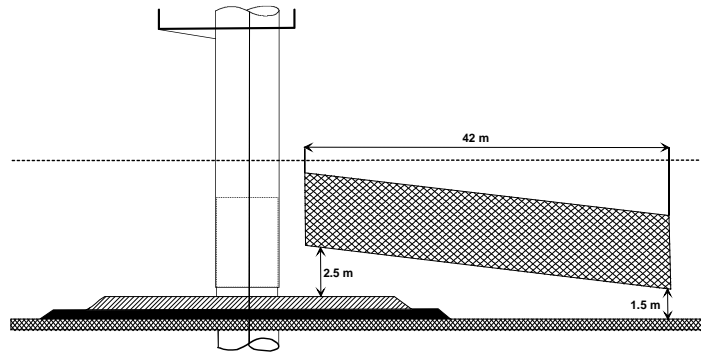

Figure 7. Illustration of the net setting close to the monopile.

### 2.1.3 Hydro acoustic surveys

The hydro-acoustic survey was conducted in September 2009 using a SIMRAD EK60 echo sounder unit with a Simrad ES 120-4x10 split-beam transducer mounted on a pan & tilt unit to perform both vertical and horizontal surveys. The use of the horizontally oriented sonar was identical with the surveys performed in 2004 and 2005 (Hvidt, et al., 2006). The horizontally oriented sonar allowed the detection of fish assemblages near or around each turbine foundation, whereas the vertically oriented sonar only covered minor areas of the foundations. No vertical survey was conducted in 2005. The sonar can only detect pelagic fish assemblages or fish assemblages living near the seabed (demersal fish species). The sonar can only exceptionally detect flatfish living on the seabed, and cannot detect burrowing species.

Transects were surveyed at a speed over ground (SOG) of 0.5-2 knots depending on the current and wave conditions.

The hydro-acoustic surveys were carried out along four transects covering the impacted and control areas (Figure 8). Both horizontal and vertical recordings were made. The impacted area was defined as inside the Horns Rev Offshore Wind Farm while the control area was located 3–7 km northwest of the Horns Rev Offshore Wind Farm. The survey transects in the impact area and the corresponding survey transects in the control area were determined by comparable depth of 8-10 m (Table 1) and comparable substrate regimes.

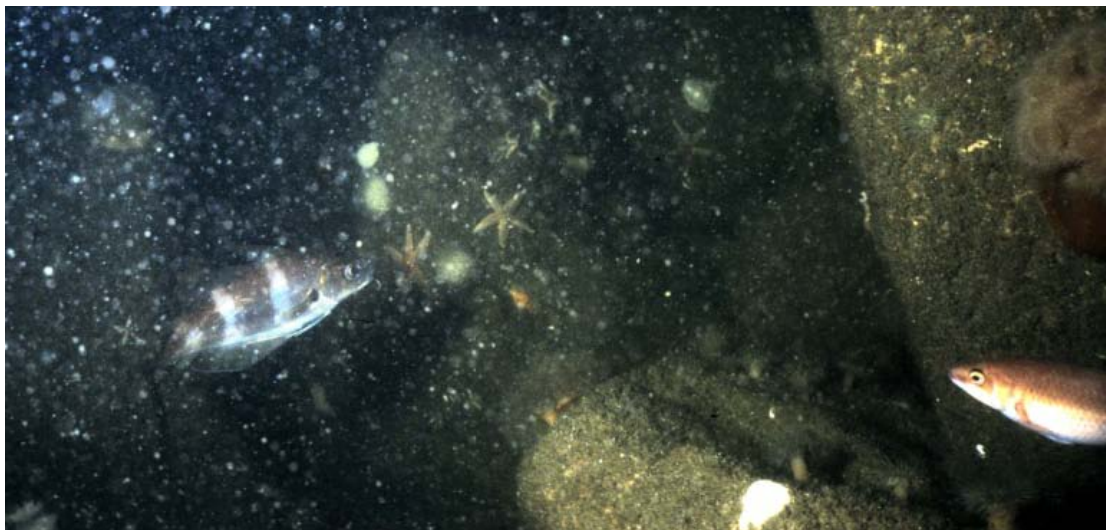

Pouting and goldsinny wrasse at the turbine foundation at Horns Reef

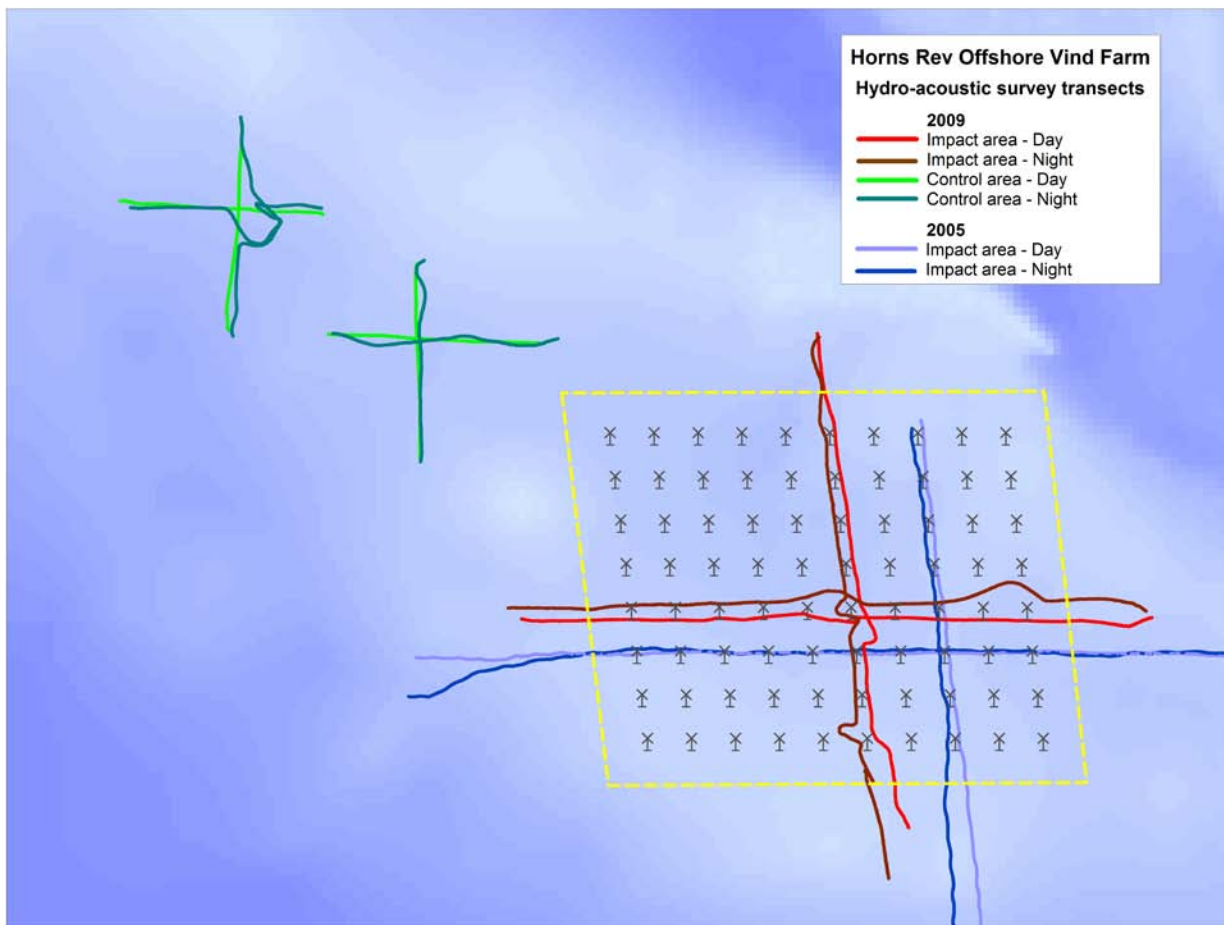

Figure 8. Hydro acoustic surveyed transects in the impact (I) and control area in September 2005 and 2009. In 2009 the transects were adjusted to cover stations used for gillnet surveys. Control areas are not comparable between 2005 (not shown) and 2009.

Transects were chosen to achieve the most identical impact and control transect pairs possible and most homogenous gradient transects possible with respect to environment and topography. Furthermore, gradient transects were placed parallel to the turbine rows and at a distance of approximately 50 m to ensure that the acoustic beam covered the foundations.

Table 4. Depths in the control and impact (I) area.

Depths (m)	Area	Mean	Min.	Max
	Control 1	10	8	14
	NS		7.5	13.5
	EW		9	11.5
	Control 2	9	8	10
	NS		7.5	10.5
	EW		9	10.5
	Impact	8	7	10
	NS		6.5	9.5
	EW		7.5	9

A total of two surveys were performed at each impact and control transect. To strengthen the statistical statement and to assess the diurnal variation, identical surveys were executed during daylight (04:40 AM – 6:10 PM, GMT) (day) and during darkness (6:10 PM – 04:40 AM, GMT) (night).

#### 2.1.4 Data analysis

The following null-hypotheses were tested:

- The community structure does not differ between the impact and control area.
- Pelagic and semi-pelagic fish assemblages are evenly distributed within the wind farm site.

Analysis for changes in fish abundances, distribution and community structure followed the BACI design. Variation in abundance was analysed by general linear models (GLM) and variation of variance (ANOVA) while community structure and composition was analyzed using multivariate statistics (ANOSIM, SIMPER).

The multivariate statistics were analyzed using the software PRIMER (Clarke and Warwick, 2001). Samples comprised 96 collected during autumn and 75 from spring, of which four outliers were excluded from the analyses. According to standard procedure using PRIMER removed outliers were samples in which 1 species was recorded (sample no. 20100308 -58-mid, 20100308-58-near, 20100310-58-near, 20100310-95-far). Three data transformations were used (none, fourth root, present/absent) to analyze the weighting of species abundance and species composition on the fish community structure. The SIMPER and ANOSIM analyses were based on Bray-Curtis similarity. Effects of the offshore wind farm structures (Before and After) were compared with seasonal changes (fall 2001 and 2009, spring 2002 & 2010) by a 2-way crossed ANOSIM. For each season, overall effects of offshore wind farms (before 2001-2002 and after 2009-2010) were compared with differences between Control and Impact stations by a 2-way crossed ANOSIM of Impacted and Control stations versus the periods of Before and After offshore wind farm construction. Detailed effects of offshore wind farm at Impact stations were compared with effects on the Control station by 1-way ANOSIM global and pair-wise tests.

Catch numbers were assumed to follow a negative binomial distribution and were analysed by a mixed model for discrete data in the R software package glmmADMB (The R project for statistical computing) (Anonymous, 2007):

$$C = BA + CI + BA \times CI + RandErr$$

where C is catch in number, BA is the Before/After establishment of the wind farm, CI is Control/Impact, and RandErr an added random effect for day and station.

The most abundant fish species were analysed on a species level while species that only occurred in smaller quantities were categorized into four groups based on their biological characteristics and habitat preference: demersal (DEM), pelagic (PEL) and reef habitat (ROC) fish.

Species diversity was calculated with the Shannon-Wiener index (H')

$$H' = - \sum_{i=1}^s (p_i \ln p_i)$$

where  $i$  is the abundance of species  $I$ ,  $S$  is the number of species,  $N$  is the total number of all individuals and  $p_i$  is relative abundance of each species, calculated as the proportion of individuals of a given species to the total number of individuals in the community at a given station and distance.

Hydro-acoustic data was analyzed using a Sonar 5, which is a software program developed by the Institute of Physics, University of Oslo, in cooperation with SIMRAD. The quality of the application program follows the internationally accepted standards for determination and analysis of biomass and size distribution of fish where definitions and terms are defined by ICES (ICES, 2008). The hydro acoustic echo signals reflected from the fish are measured as target strength (TS). The target strength varies according to species specific morphology of individuals.

Only the total acoustic signal (SA) was used for comparison of different fish assemblages inside the impact area and for comparison with the fish assemblages in the control site outside the wind farm. Due to different locations for the control sites in 2005 and 2009 data for the control area in 2005 are not used for comparison between years. Data for 2005 are only used for comparison between years in the impact area. No attempt was made to calibrate the acoustic signals to different species occurring in the area.

The hydro acoustic echo signals reflected from the fish are measured as target strength (TS). The target strength varies according to species specific morphology of individuals. Tracks of target strength (TS) or observed echoes greater than a threshold of -54 dB were accepted in order to avoid tracks or echoes from objects of low TS values like jellyfish and small crustaceans. Unfortunately this threshold is higher than the target strength of -68.9 dB for sandeels (Mackinson, et al., 2005).

Only the total acoustic signal (sA) was used for comparison of different fish assemblages inside the impact area and for comparison with the fish assemblages in the control site outside the wind farm. No attempt was made to calibrate the acoustic signals to different species occurring in the area.

The acoustic survey data were analysed in a full ANOVA in respect to the following variables (Table 5).

Table 5. Variables and values used in the ANOVA test for differences between acoustic surveys 2005-2009.

Variable	Values
Effect	Between turbines
	Within turbine buffer
Year	2005
	2009
Direction	East-West survey
	North-South survey
Day/Night	Day
	Night

## 2.2 SANDEEL ASSEMBLAGES

Surveys in 2002 and 2004 were conducted between 10<sup>th</sup> and 14<sup>th</sup> March. The September 2009 survey was repeated twice: day and night (between 8<sup>th</sup> and 10<sup>th</sup> September). The survey in March 2010 was repeated three times: early (28<sup>th</sup> February), mid (8<sup>th</sup> to 11<sup>th</sup> March) and late March (22<sup>nd</sup> to 23<sup>rd</sup> March). Except for the night-time replicate in 2009, all sandeel samples were collected between 8 AM and 6 PM. During the day the research vessel alternated between sampling in the impact area and the control area to avoid the influence of potential day time effects on sandeel catchability.

In total, 63 positions were defined in a regular grid in the area of the wind farm (impact area) and 9 positions in an area north-west of the wind farm (control area)

(Figure 9). Prior to each survey, between 4 and 10 sample locations in the impact area and between 4 and 7 sample locations in the control area were randomly chosen from the respective grids (Table 6). The surveys were repeated three times in March 2010: early, mid and late March; and two times in September 2009: Day and night. These replicate surveys provided a foundation for assessing the seasonal and diurnal effect on sandeel catchability.



Sandeel catch at Horns Reef. In the catch more sand gobies, one pipefish and one small scupin (only the snout visible) can be recognised. One larger specimens of greater sandeel are easily identified by a black spot on the snout. Besides numerous brown shrimps, common starfish and razor shells can be seen.

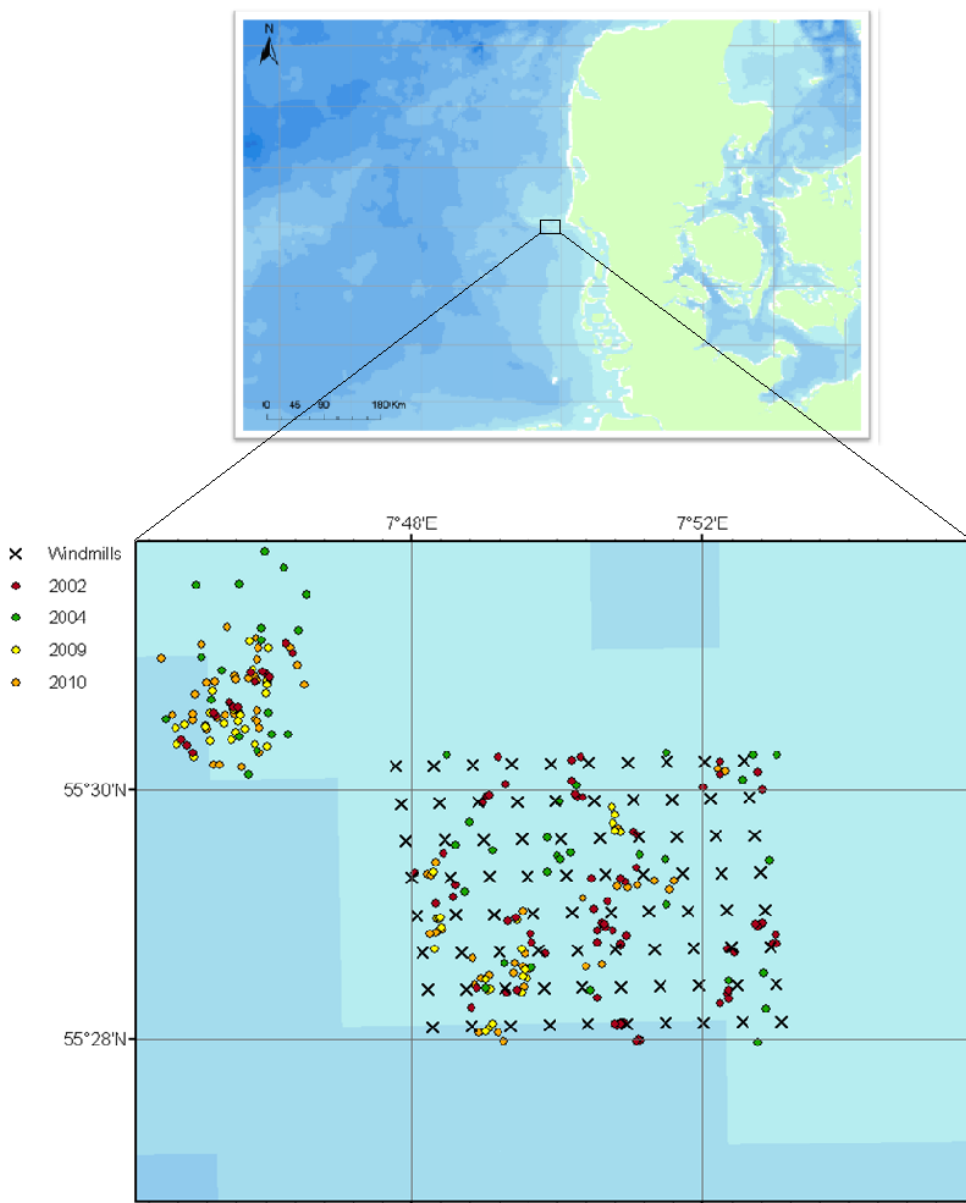

Figure 9. Map of sampling locations in the Horns Rev I area. Control area located NW of impact area

Table 6. Number of sampling positions randomly selected. Numbers in parenthesis refer to the late March survey in 2010

Month and year	Impact area	Control area
2002	10	7
2004	8	4
2009	4	4
2010	7(4)	7(4)

A 1.225 m wide modified scallop dredge, with a mesh size of 5.5-6.5 mm, towed behind a research vessel, was used to collect sandeel samples during the day at each of the sample locations. During each day the research vessel alternated between sampling in the impact area and the control area to avoid the

influence of potential day time effects on sandeel catchability. Dredging has been found to provide accurate measurements of relative densities of sandeels in the seabed (Jensen, 2001; van der Kooij, 2008). As both March and September are outside the main period of sandeel activity in the North Sea (e.g. Winslade, 1974b; Wright, *et al.*, 2000; Høines and Bergstad, 2001; van Deurs, *et al.*, 2010) the bulk of the sandeel population was expected to reside in the sediment during most of the day. Sampling at night was in general avoided due to difficulties of manoeuvring between the wind turbines in the dark. September 2009 was an exception, when an additional night time survey was completed. Three to five replicate dredge samples were carried out at each of the sample locations, with each dredge sample represented by a 10 minute haul covering a distance between 400 m and 1200 m on a straight line, depending on current velocity and weather conditions. The start positions of the dredge hauls for each of the sample locations are shown in Figure 9. The sandeels caught in the dredge were frozen for later laboratory analysis. Sandeels were counted and the weight and length of the fish were measured in grams and mm. Other species only occurred sporadically and few in numbers. Sandeel species were identified using species basic features (Table 7). Maturity staging of the differing species of sandeels was not possible due to differences in the timing of the reproductive cycles among species. Aging, based on otoliths, was also considered to be largely uncertain as this method has only previously been practiced on *lesser sandeel*. As a result a crude ontogenetic classification was used, where juvenile sandeels were defined as fish smaller than 10 cm and adults as fish larger than 10 cm.

Table 7. Characters of sandeels. Based on (Reay, 1970; Reay, 1973; Reay, 1986) and (Macer, 1966), except \*) which is a new character discovered by Henrik Jensen, National Institute of Aquatic Resources.

	<i>A. marinus</i>	<i>A. tobianus</i>	<i>H. lanceolatus</i>	<i>G. semisquamatus</i>
Spawning time	Dec-Jan	Feb-Apr Sep-Nov	Summer	Summer
Habitat depth	30-150 m	~0-30 m	~0-150 m	20-200 m
Premaxillae protrusible	Yes	Yes	No	Yes
Dark spot on either side of snout	No	No	Yes	No
Lateral line system	Not branched	Not branched	Not branched	Branched
Vomerine teeth	Absent	Absent	Present Single bicuspid tooth	Absent
Scales at base of caudal fin	Max. 2-3 Extremely rarely	Min. 6		
M-band at the base of the caudal fin*	Absent	Present	Absent	Absent
Total vertebral number	65-75	61-66	65-69	65-72
Dorsal fin ray number	56-63	49-58	53-60	56-59
Anal fin ray number	29-33	24-32	27-32	28-32

Sandeel gut contents were collected but not analysed from both the impact area and the control area during the March 2010 survey.

### 2.2.1 Data analysis

The following null-hypothesis was tested:

- Numbers of sandeels does not differ between the impact and control area.

This null-hypothesis was tested for each sampling year, each species, and for juveniles and adults respectively. Testing of the null-hypothesis was carried out using the two following statistical models, where model 1 is a general linear model assuming a negative binomial distribution of data and model 2 is logistic regression model.

$$\text{Model 1: } \text{Log}E_{i,u} = \text{Log}(L_i) + V_u + S$$

$$\text{Model 2: } \text{Logit}(P_{i,u}) = L_i + V_u + S$$

where  $E_i$  is the numbers of fish in sample  $i$  and  $P_i$  is the probability of having at least one observation in sample  $i$ .  $L_i$  is the distance hauled to get sample  $i$  and  $S$  is the sampling position.  $V$  has two levels:  $u =$  Impact area or  $u =$  control area. It is the significance of the parameter estimates for  $V_u$  that determines whether the null-hypothesis can be rejected.



Sandeel dredge

Model 1 uses absolute counts of sandeels in samples (numbers), and was applied when null-samples (samples containing zero observations) were rare and the number of observations per sample was high. Model 2 was applied when null-samples were frequent and number of observations per sample was low, and uses presence/absence data (occurrence). The main threshold of statistical significance was defined as  $P = 0.05$ . However, in the results we distinguish between marginally significant ( $0.1 > P > 0.05$ ), significant ( $0.05 > P > 0.001$ ) and highly significant ( $P < 0.001$ ). The `glm.nb` and `glm` procedure in R (The R project for statistical computing) (anonymous, 2007) was used to implement the statistical models; in the latter case by choosing a binomial distribution and a logit link function (Hastie and Pregibon, 1992). In order to avoid committing type II errors in our conclusions, that is accepting the null-hypothesis where it should have been rejected, the statistical power of model 1 is assessed, using a boot-strap based approach (Appendix VII).

The following equations were applied to account for variation among samples in the distance covered with the sandeel dredge. Equation 1 produces the distance ( $L$  [m]) covered by the dredge for each sample and equation 2 produces the sandeel catch rate represented as number of sandeels per 1000 square meters fished:

$$L = \arccos \left\{ \sin\left(\frac{LAT_{start}}{180} \times \pi\right) \times \sin\left(\frac{LAT_{end}}{180} \times \pi\right) + \cos\left(\frac{LAT_{start}}{180} \times \pi\right) \times \cos\left(\frac{LAT_{end}}{180} \times \pi\right) \times \cos\left(\frac{LONG_{start}}{180} \times \pi - \frac{LONG_{end}}{180} \times \pi\right) \right\} \times 6.378 \times 10^6 \quad (\text{Eq. 1})$$

$LONG_{end}$ ,  $LONG_{start}$ ,  $LAT_{end}$ , and  $LAT_{start}$  are the longitude and latitude (as decimal values) for the start and end positions of the dredge-haul.

$$Catch\_rate = E / L \quad (\text{Eq. 2})$$

$E$  is the number of fish observed in the sample (equaling to  $E_i$  in model 1).

## 2.2.2 Sediment

Three replicate sediment samples were taken at each sampling location using a  $0.2\text{m}^2$  van Veen grab. Replicate sediment samples were necessary as the sediment type may vary significantly over relative small distances in areas with sandeels populations (Jensen, 2001). The sediment samples were emptied into a plastic container and a sub-sample of c. 5 kg of the total sample was taken. The sediment samples



were dried for 24 hours at 100°C and homogenized afterwards. A sub-sample of between 100 g and 140 g was sieved through a standard Wentworth series of sieves ranging from 2,000-63 µm mesh, with the aid of a mechanical shaker. The sieve analyses were carried out by the Geological Survey of Denmark and Greenland (GEUS) following the standard DS 405.9.

### 2.2.3 Simulation of larvae drift for *lesser sandeel* and *greater sandeel*

Using bio-physical modelling (Christensen, *et al.*, 2007; Christensen, *et al.*, 2008) it is possible to calculate oceanic current transport of fish larvae (assuming passive drift). This provides better insight into whether Horns Rev functions as a random place where larvae culminate after a long ocean current transport or whether sandeel species utilize this area as a spawning site where the larvae remain.

The model is based on hydrographic data (2004, 2005 and 2006) from an operational sea model (BSHcmod) performed by DMI (Dick, *et al.*, 2001). The model simulated 100,000 sandeel larvae (particles) that were either set to run with or against currents from Horns Rev.

19 samples of *greater sandeel* otoliths from September 2009 were sanded, polished, and photographed. Using imaging software (Image Pro 5.2) the daily rings in both the larval stage and the juvenile stage were counted (Figure 10).

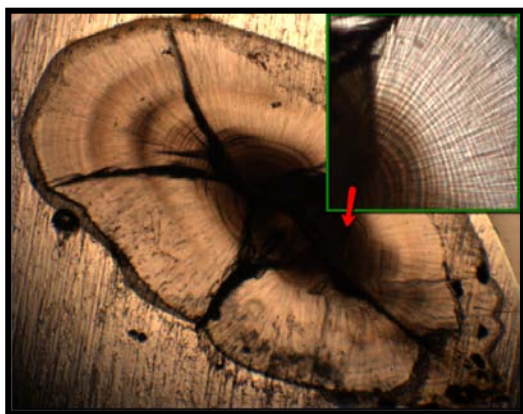

Figure 10. Example of a sanded and polished otolith from a juvenile *greater sandeel* photographed under a stereo microscope.

Of the surveyed *greater sandeel*, the mean hatched egg date was calculated to be on 15<sup>th</sup> May (SD ± 12 days) and mean metamorphosis calculated to the fifth of July (SD ± 8 days). Based on the literature *lesser sandeel* eggs were set to hatch on the first of March (SD ± 8 days) and metamorphosed the first of May (SD ± 8 days) (Macer, 1965; 1966; Wright, *et al.*, 1996; Boulcott and Wright, 2008).

### 2.2.4 Species distribution modelling

To be able to define potential differences in the spatial distribution of sandeels before (year 2002) and after (years 2004, 2009 and 2010) the construction of the wind farm in the Horns Reef area attempts to build species distribution models by using generalized additive models (GAMs) were made. Species distribution models, including GAMs, can be used to relate the density of sampled species to potentially important environmental variables (Guisan and Zimmermann, 2000; Franklin, 2009). The model can thereafter be used for describing the relationship to the different environmental variables and to predict the distribution at unsurveyed sites. To be able to describe the responses to environmental variables it is important to include whole gradients of environmental variables in the samples.

Species data was divided into two modeling data sets. In the first data set only samples with densities collected in 2002 were included. In the second data set all sampled densities collected after the construction was included (years 2004, 2009 and 2009) and density of all sandeel species was used as the response variable in the GAM. For sample locations see Figure 9.

Environmental variables as depth, bottom slope, median grain size, curvature and distance to turbines were used as predictor variables (Table 8 and Figure 11). All variables had a resolution of 100x100m. The depth raster was based on the DHI bathymetry model. Median grain size was interpolated values from all available sources. The slope raster was based on bathymetry and calculated using the standard “slope tool” in ArcGIS. Curvature was also calculated in ArcGIS using the standard “curvature tool”. Curvature describes the complexity of the bottom surface, 0 is flat, a negative value indicates an upwardly convex surface and a positive value indicates an upwardly concave surface.

Table 8. Mean (min-max) of the environmental variables.

	Year 2002	Years 2004, -09, -10
Density	0.002 (0-0.016)	0.004 (0-0.27)
Depth	-8.511 (-11.137 - -5.060)	-8.463 (-11.052 - -3.513)
Slope	0.127 (0.041-0.301)	0.109 (0.023-0.360 )
Grain size	0.389 (0.308-0.452)	0.4062 (0.3076 -0.4553)
Curvature	-0.00017 (-0.005-0.005)	-0.00006 (-0.0017-0.0019)
Distance to turbines	309.9 (100-501)	365.5 (0-501)

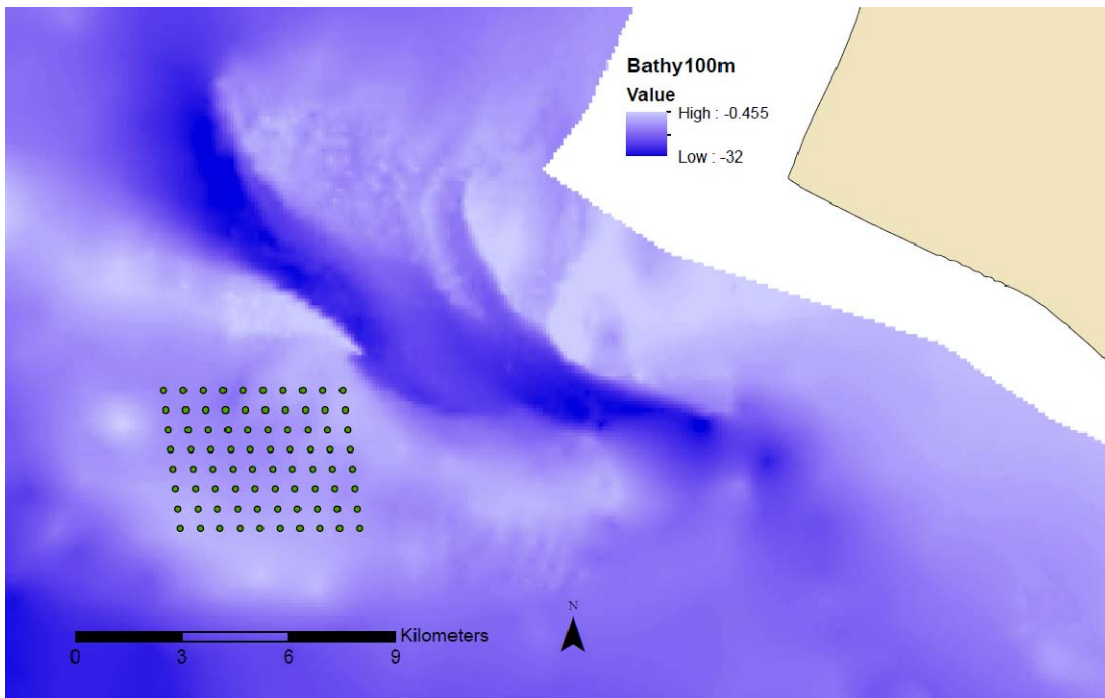

Figure 11. Visualisation of the variable describing depth. Turbines are indicated as green dots.

Generalised additive models (GAM) was used as modelling algorithm. It is a data driven approach and able to handle non-linear responses and distributions. Mgcv library in R was used to fit the models which automatically choose the degree of smoothing for each variable (see for example (Wood and Augustin, 2002; Wood, 2006) for details). The models were fitted with a quasipoisson family distribution which was found to best handle the over dispersion in the data and also a Tweedie distribution was tried.

The models were used to predict the distribution and density of sandeels in the Horns Rev region. For this purpose a prediction file was used covering the whole study area with a resolution of 100x100 m including values of all environmental variables used in the modelling.



### 3 Results

#### 3.1 FISH COMMUNITY

From autumn 2001 until spring 2010 a total of 45 different species were registered during the surveys in the Horns Reef area (Appendix I).

Although the sampling effort and methods used during the monitoring of the faunal colonisation of hard substrates in 2003-2005 were different and not directly comparable to the gillnet studies in 2002-2003 (Before) and 2009-2010 (After) the observations of species are included in the total number observed.

Based on the gillnet data the diversity of species increased after the establishment of the wind farm (Figure 12). A total of 41 species were observed within the impact area, including visual observations of species made by SCUBA divers, compared to the 30 species, which were found in the control area or in the impact area before construction in 2003.

Four of the species only registered in the impact area - *ballan wrasse* (*Labrus bergylta*), *painted goby* (*Pomatoschistus pictus*), *broadnosed pipefish* (*Syngnathus typhle*), and *longspined bullhead* (*Taurulus bubalis*) - were only observed by the divers and therefore their presence in the impact area were not verified by corresponding catches in gillnet or trawl surveys. During the sandeel sampling only very few species low in numbers were identified and all occurring species were also registered in the gillnet samples. In the grab samples a few *sand gobies* (*Pomatoschistus minutes*) and one specimen of *broadnosed pipefish* (*Syngnathus typhle*) were observed. Pipefish were also recorded in the trawl surveys although, low in numbers they were more abundant in the control area together with *dab* (*Limanda limanda*) compared to the impact area, whereas *herring* (*Clupea harengus*) was recorded only in the impact area (Appendix II). In general the catches in the trawl were very low.

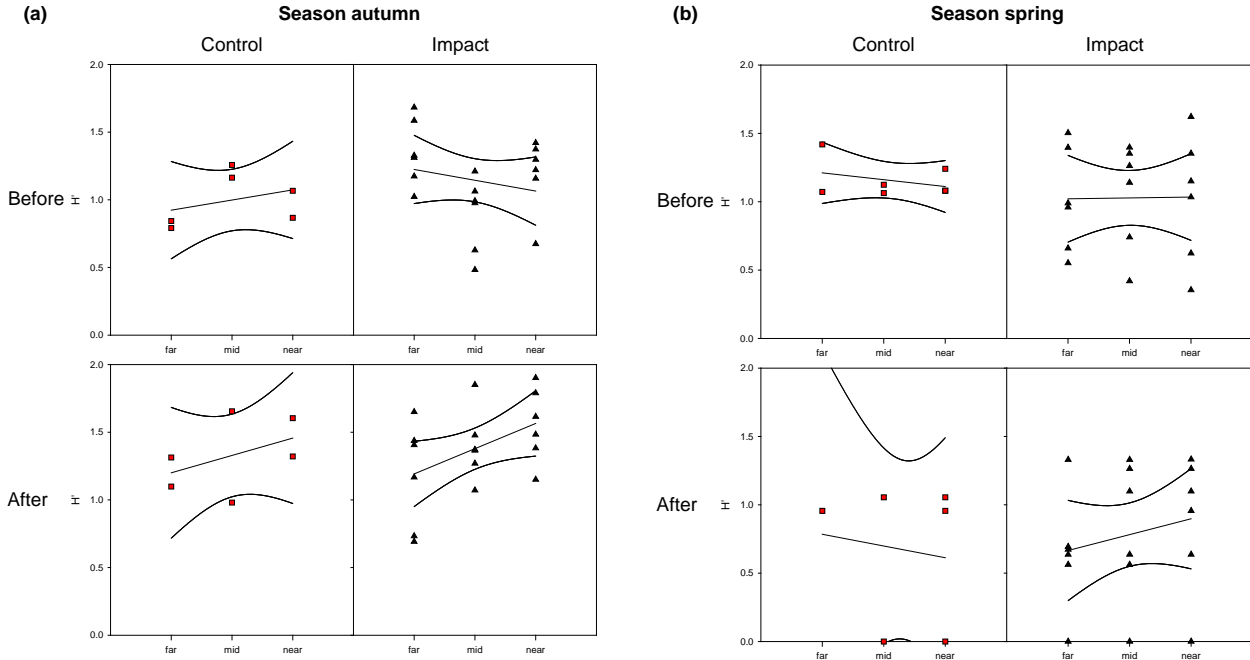

Figure 12. Shannon-Wiener index ( $H'$ ) for species diversity at distance to turbine (far, mid and far) at the different surveys and control/impact area. Linear regression with 95% confidence intervals shown.

Results from the gillnet surveys showed a higher diversity in the impact area compared to the control area after the construction. Difference between season was greater than between sites ( $p < 0.01$ ) with higher species diversity in the fall surveys. Analysis was thus performed per season. For both seasons there was a significant effect of before-after (BA), but no effect of site or any interactions effects

(CIxBA) (Table 9). However, the effect of before-after was opposite directed for the two seasons as diversity increased in the autumn but decreased in the spring survey after construction.

Table 9. Test statistics on Shannon-Wiener index ( $H'$ ) on effects of Before (B), After (A), Control (C), Impact (I) design with estimated  $H'^A$  on significant effects.

Season	Source	DF	Type III SS Mean Square	F Value	Pr > F	$H'^A$
Fall	BA	1	0.71727	7.58	0.0085	B=1.07; A=1.35
	CI	1	0.08632	0.91	0.3446	
	BAxCI	1	0.02077	0.22	0.6416	
Spring	BA	1	1.42366	8.68	0.0054	A=1.1; A=0.65
	CI	1	0.05722	0.35	0.5582	
	BAxCI	1	0.37896	2.31	0.1366	

The most abundant species in the surveys were whiting (*Merlangius merlangus*), dab (*Limanda limanda*), and sandeels (*Ammodytidae* spp.). These species contributed with 77-84% of the catches in the surveys before construction and in the autumn survey after construction in both the control and impact areas (Figure 13). Dab was caught in all four gillnet surveys, whereas whiting and sandeel were only caught in high abundance in three respectively two of the surveys (Appendix IV). The spring survey after construction was dominated by clupeids herring (*Clupea harengus*) and sprat (*Sprattus sprattus*) and hooknose (*Agonus cataphractus*). However, even though they contributed to most of the catch, the catch rates in this survey were very low (Appendix IV). Hence, the three most abundant species/species groups, whiting, dab and sandeel were treated separately, while the remaining species were pooled into the groups demersal fishes (DEM), pelagic fishes (PEL) and reef habitat fishes (ROC) in the following interpretation of results (Appendix III).

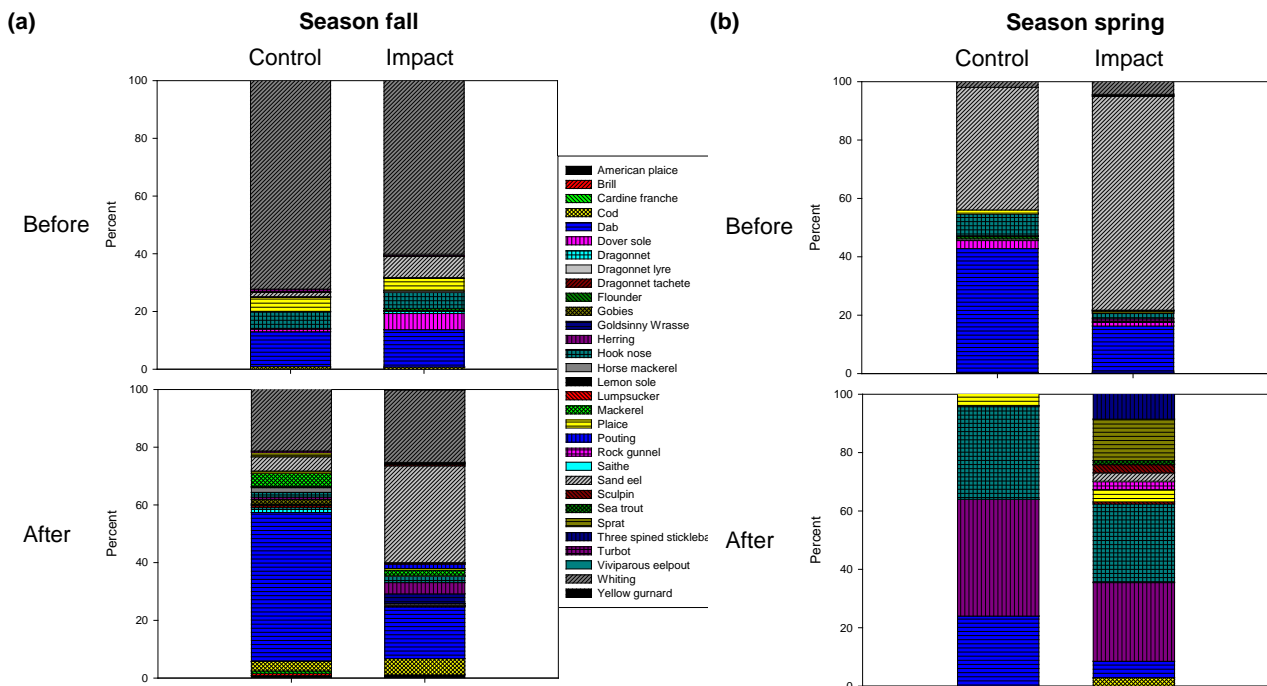

Figure 13. Species distribution in fall (a) and spring (b) surveys before after and control impact.

Fish sizes were in both seasons and areas dominated by relatively small fish below 30 cm in length. Size distributions for the whiting, dab and sandeel had modal lengths (most frequently length) of respectively 12-14; 20-22 and 12-14 cm (Figure 14). There was no significant difference in size distribution in the autumn and spring surveys between Before-After or Control-Impact ( $p>0.09$ ) (Appendix V).

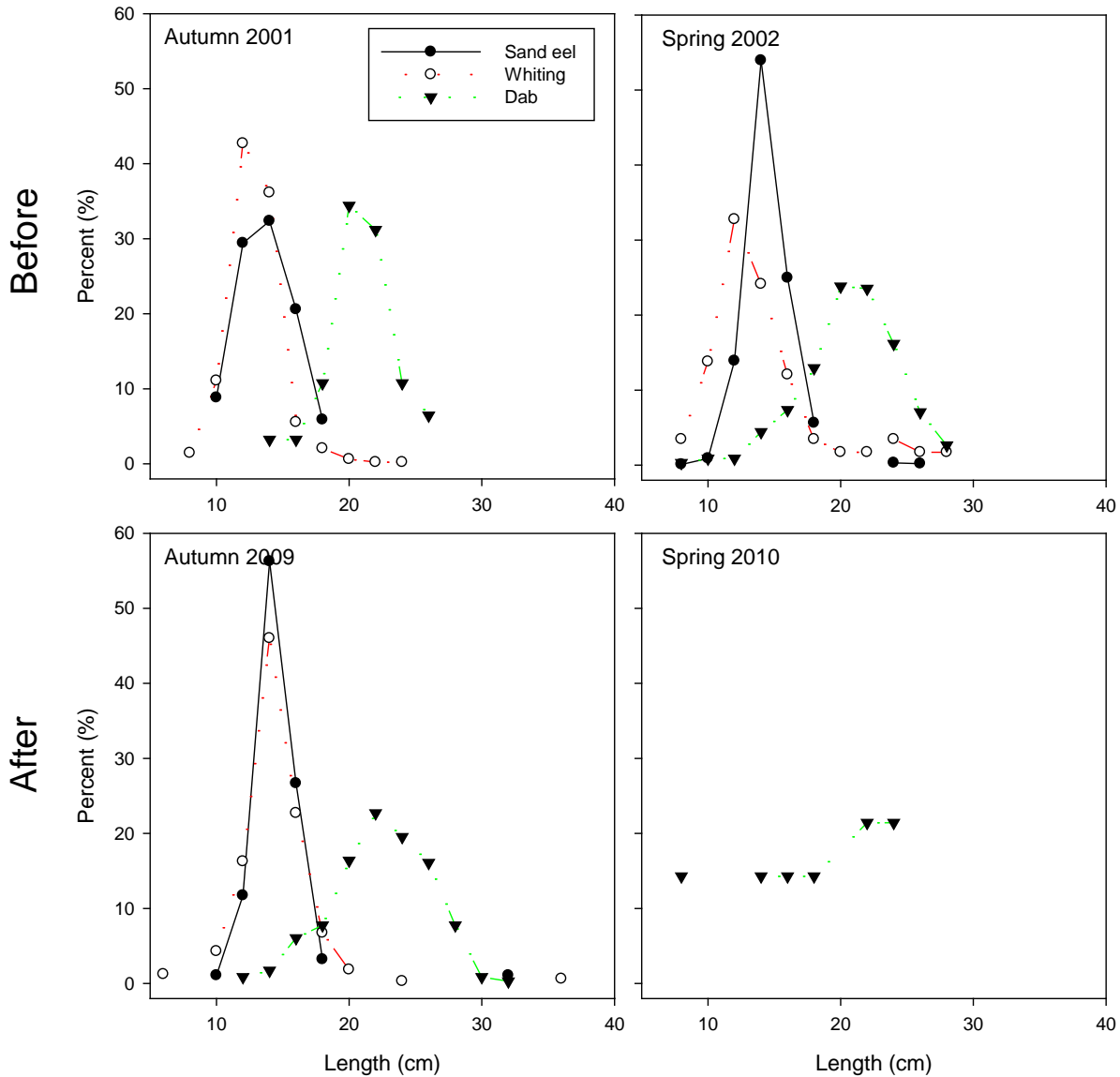

Figure 14. Size distribution in 2-cm intervals for the most common fish species on the surveys: Before (top panel) and After (low panel) in autumn (left panel) and spring (right panel).

### 3.1.1 Community structure

The results of the multivariate analysis (MDS), describing similarities in the fish community structure between the impact and control sites in a situation before and after construction, showed that fish abundances and diversity differed to some extent between seasons, whereas the effects of the wind farm deployment appeared to be negligible. In the MDS plot the first mentioned result is shown as more or less two separated groups, with relatively short distance between identical symbols corresponding to the two seasons, whereas identical symbols representing the before and after situation is not or only in part separated in two groups (Figure 15). Thus, fish community structure was analyzed independently for fall and spring to detect changes at a detailed level. Because fish migration from deeper waters towards the

shore was delayed following the unusually cold winter 2009-2010, only the autumn surveys were used in the detailed BACI analyses of fish community structure.

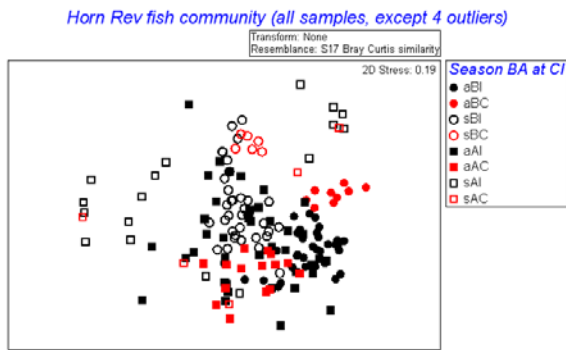

Figure 15. MDS (multidimensional scaling) plots of fish community similarities (Bray-Curtis) based on non-transformed data of sites collected in autumn (solid) and spring (open), before 2001-2002 (circle) and after 2009-2010 (square) wind farm construction at impacted (black) and control (red) stations.

Large variations are found both in the impact and control area and between individual turbine sites (Figure 16) (in the MDS long distance between groups). This result supports that the Horns Rev fish community structure varied more between the control and impact area than between years. The MDS plot showed a larger variation (long distance between identical symbols – solid) between samples from 2009-2010 compared with samples from 2001-2002 (shorter distance between identical symbols – open).

In the autumn analyses of specific differences in species composition showed that the species number increased from 2001-2002 to 2009-2010 (Figure 13). However, decrease of a single species,

*whiting*, accounted for ~81% of a smaller difference between samples from 2001-2002 and 2009-2010 (across Control-Impact) (Appendix VIII). Larger differences were found between the control and impact area (across Before-After), in which *whiting*, accounted for ~91% (Appendix VIII). In comparison, analyses of specific differences in species composition in spring showed that the species number also increased from 2001-2002 to 2009-2010 (Figure 13). Compared to autumn species composition, differences were larger in spring, in which sandeels accounted for ~79% of the difference. The largest difference were found in spring between the control and impact area (across Before-After), in which *whiting*, accounted for ~43% and sandeels accounted for ~37% (80% in total).

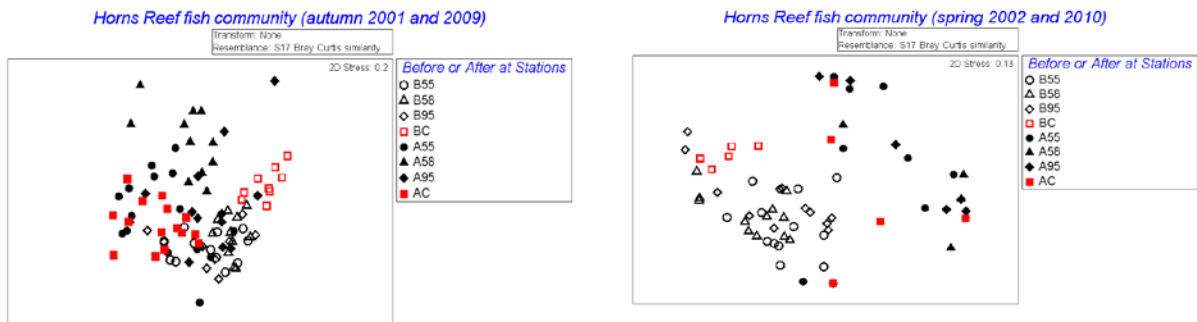

Figure 16. MDS (multidimensional scaling) plots of fish community similarities (Bray-Curtis) based on non-transformed data of sites collected in autumn (2001 and 2009) and in spring (2002 and 2009) before (open symbol) and after (solid symbol) wind farm construction at three impacted (black) and one control (red) stations (test statistics in Appendix VIII).

The spring analysis was hampered due to unusually cold winter 2009-2010, which delayed immigration of fish from deeper to shallow waters. Taken this into consideration, results showed that variances between samples were much larger in spring 2010, in which very few fish were found, compared to spring 2002 (Figure 16). The detailed spring analysis of impacted and control stations (Before-After) showed considerable differences between several sites (Before-After) (Appendix VIII). However, differences between control and impacted sites to the same time (B and A, respectively) were not significant. Thus, this result is in line with the overall results showing high spatial and temporal variability in distribution and occurrence in the fish community and only insignificant effects of the presence of the wind farm.

### 3.1.2 Abundance

As documented above the gillnet surveys showed significant difference between autumn and spring surveys with generally higher fish densities in autumn which correspond to the observations made by divers. The very low catch in the spring survey after construction for almost all species somewhat hampered the statistical analyses of the spring season. Details of the analyses of the fixed effects in the BACI design for the autumn and spring surveys are shown in Appendix VIII. Abundance of *whiting* (*Merlangius merlangus*) in autumn differed significantly between period (Before-After) and site (Control-Impact) and significant interactions between periods and sites were found (Appendix VIII). Highest numbers of *whiting* were found before the construction of the wind farm in both sites and after construction the numbers declined significantly (Figure 17a). Before construction significant differences in abundance were observed between the two sites (Control-Impact), where higher abundances was found in the control area ( $p < 0.0001$ ) while there was no difference between the sites (Control-Impact) after construction ( $p > 0.75$ ). In spring surveys only low numbers (Before) or no *whiting* (After) were caught.

In the autumn surveys *dab* (*Limanda limanda*) occurred at similar densities both before and after construction (Figure 17b) ( $p > 0.8$ ). In both surveys there was a significant effect of site (Control-Impact) with higher densities found in the control area ( $p < 0.014$ ). In the spring surveys the largest effect was found between years (Before-After) with significant lower numbers of *dab* found after the construction ( $p < 0.0001$ ), but also a significant difference between the control and impact area was found with higher abundances in the control area ( $p < 0.0001$ )

Sandeels (*Ammodytidae*) showed no significant differences in abundance between years (Before-After) or between sites (Control-Impact) in autumn (Figure 17c) ( $p > 0.12$ ). In the spring surveys a decline in abundance was evident from 2002 to 2010.



Sandeel sampling at Horns Rev

The remaining fish species, which all occurred in lower numbers were categorised into groups described above. Bottom dwelling or demersal fish (DEM) showed the same tendencies as seen above for *whiting* in autumn with significant difference between years (Before-After) (Figure 19a) ( $p < 0.001$ ), and a change between sites (Control-Impact) with higher abundance in the control area before construction ( $P < 0.001$ ) and no difference between the sites (Control-Impact) after construction ( $p > 0.47$ ). In spring demersal fishes also showed a significant decline in abundance from before to after construction where higher numbers was found in the control area compared to the impact area before the construction while there was no difference between the sites after ( $p > 0.38$ ). Pelagic (PEL)

and reef habitat fishes (ROC) differentiated from the other species and groups by an increase in abundance after the construction during both seasons (Figure 19b).

The increases were from almost none to moderate numbers which hampered direct statistical analysis of BACI effects. However, it was evident that reef habitat fishes (ROC) after the construction and deployment of boulders and turbine foundations was found in numbers - up to 12 specimen per gillnet - in the impact area, whereas these fish species were totally absent in the control area (Figure 19c).



**(a) Whiting**

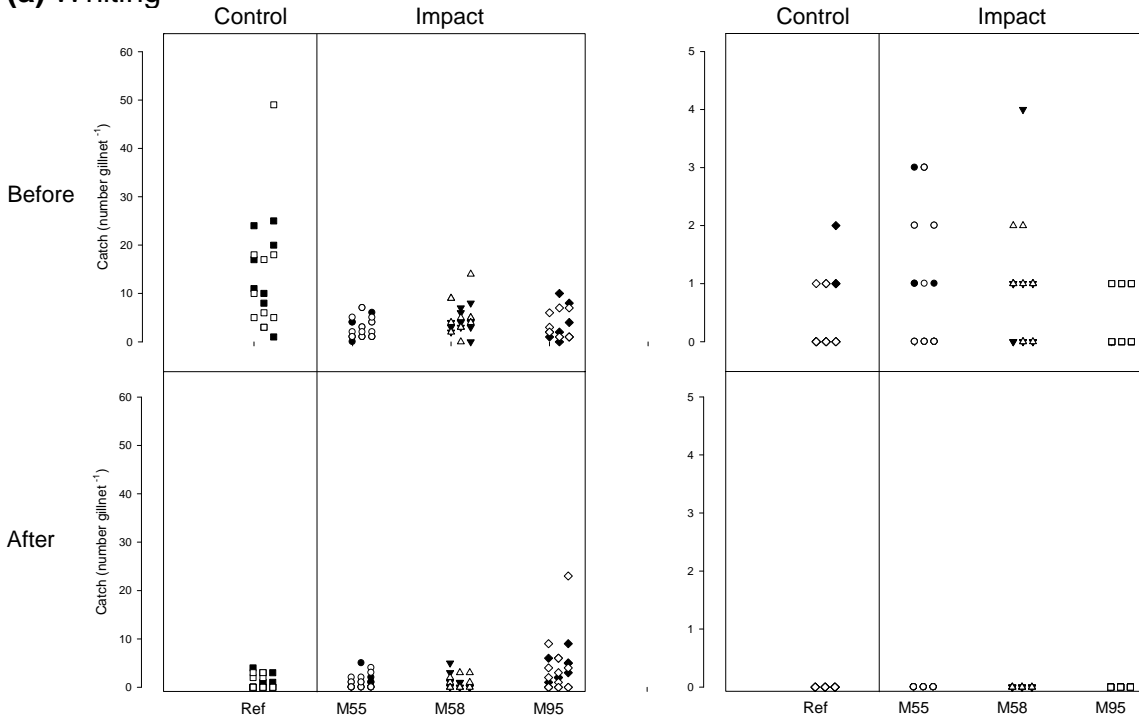

**(b) Dab**

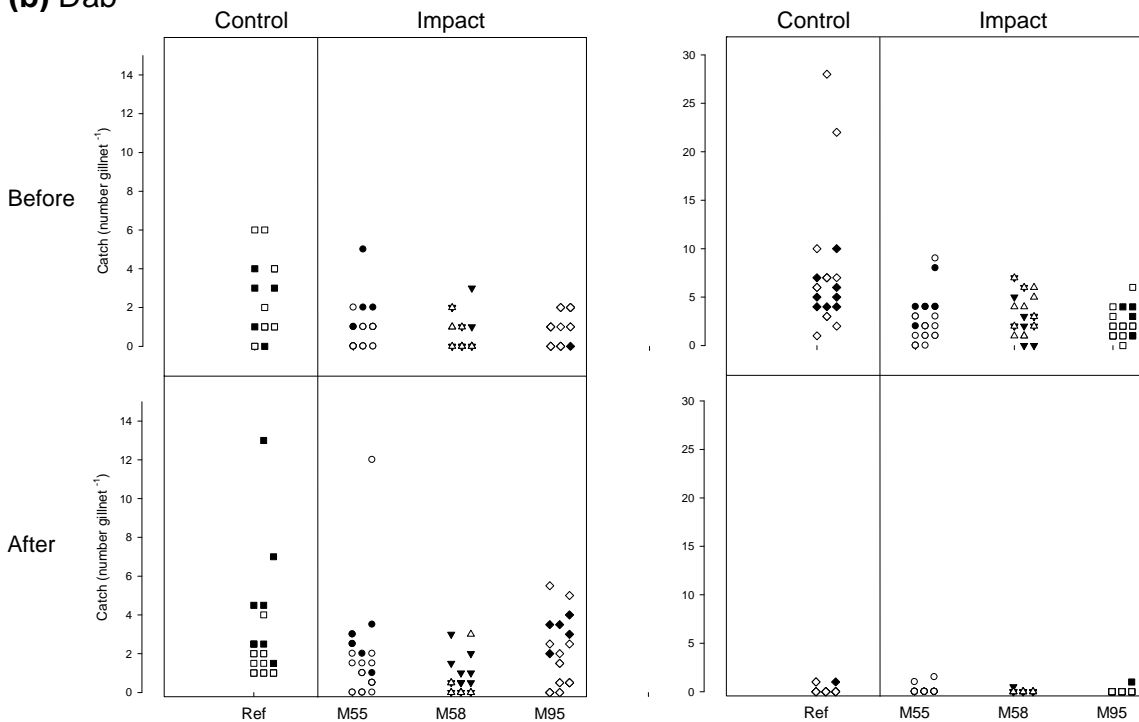

Figure 17 (to be continued). Catch in numbers for the most abundant species per gillnet setting before and after in control (Ref) and impact area (locations M55, M58 and M95) in fall (left panel) and spring (right panel). Black and white fill symbols indicate gillnet set respectively north and south of the station. The gillnet set at the 3 distances (near, middle and far) from the station is illustrated from left (near) to right (far) at the location tick. Note different scales on Y-axis between species and fall–spring.

**(c) Sandeel**

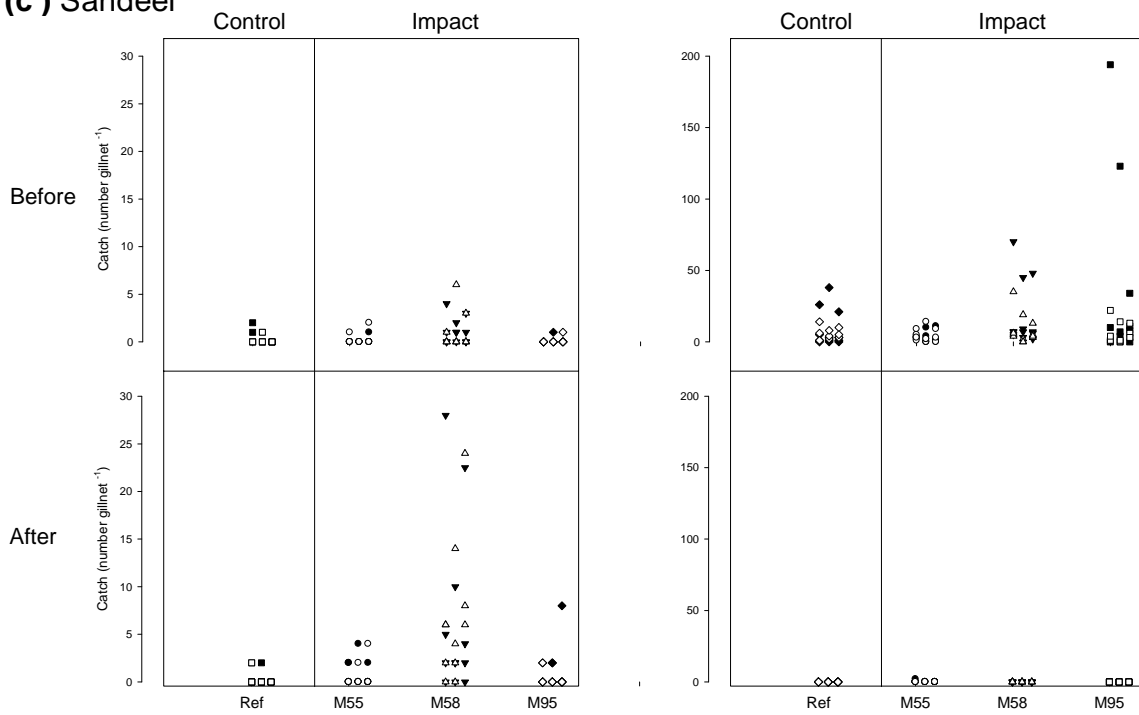

Figure 18 (continued). Catch in numbers for the most abundant species per gillnet setting before and after in control (Ref) and impact area (locations M55, M58 and M95) in fall (left panel) and spring (right panel). Black and white fill symbols indicate gillnet set respectively north and south of the station. The gillnet set at the 3 distances (near, middle and far) from the station is illustrated from left (near) to right (far) at the location tick. Note different scales on Y-axis between species and fall–spring.

**(a) DEM**

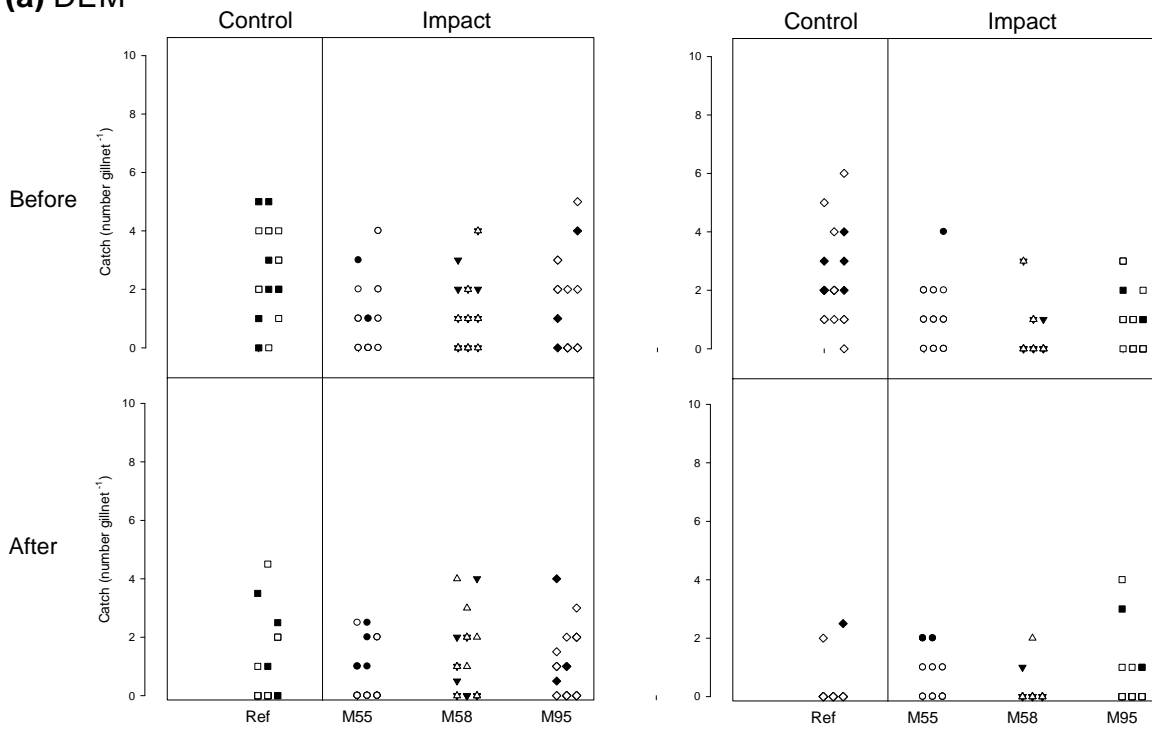
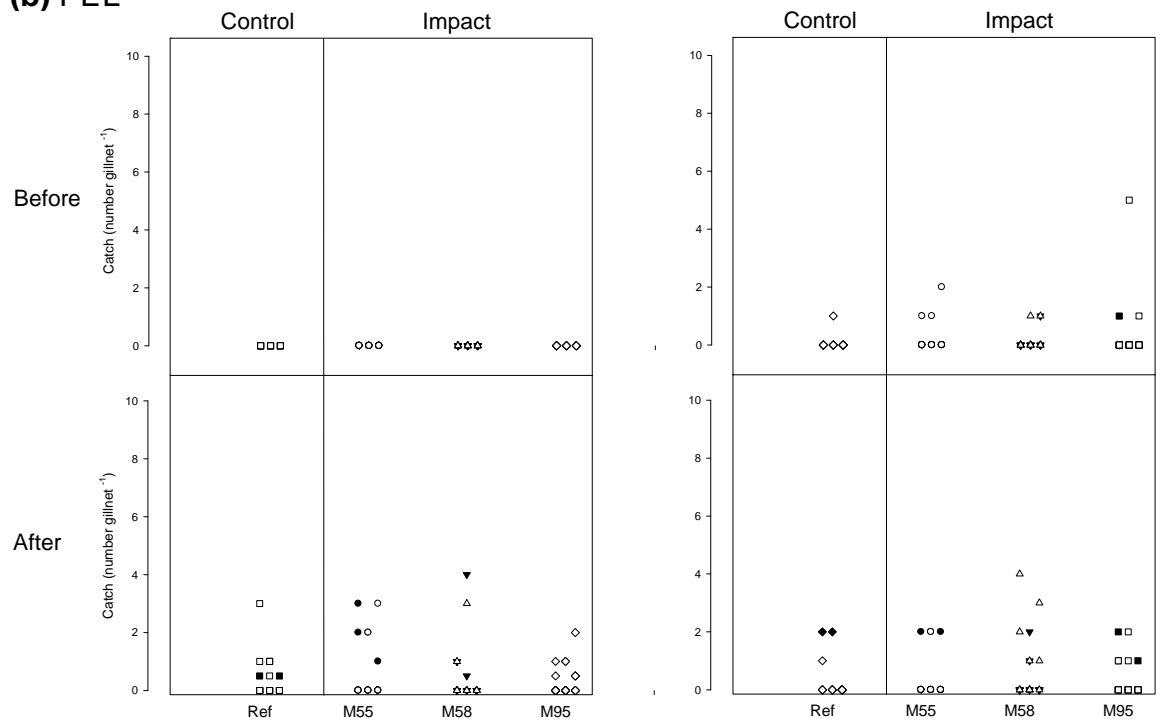

Figure 19 (to be continued). Catch in numbers for demersal fish (DEM) (a), pelagic fish (PEL) (b) and reef habitat fish (ROC) (c) per gillnet setting.

**(b) PEL**



**(c) ROC**

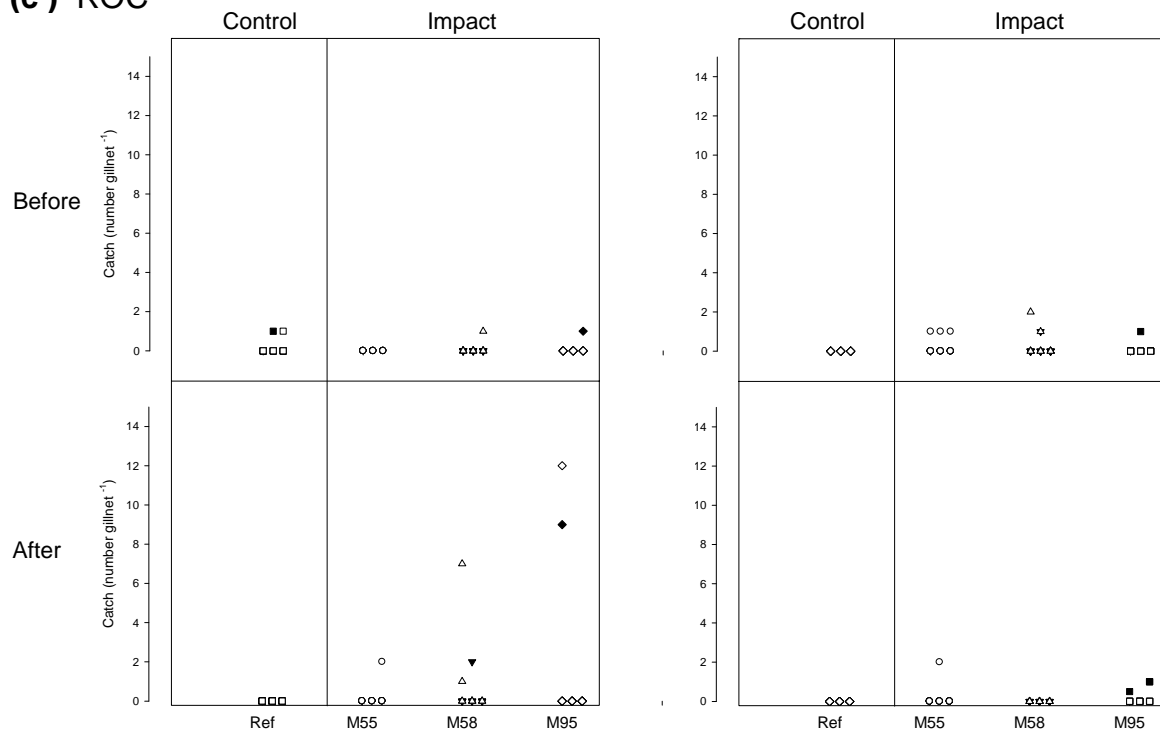

Figure 20 (continued). Catch in numbers for demersal fish (DEM) (a), pelagic fish (PEL) (b) and reef habitat fish (ROC) (c) per gillnet setting.

## Hydroacoustics

During the hydroacoustic survey, which only covers two days of the spatial distribution of the pelagic and demersal fishes, except sandeels in the surveyed area, higher abundances were observed in the control area compared to the impact area (Figure 21). The abundance seemed to increase westwards during both day time and night. In the vertical surveys covering mostly areas without foundations in the impact site comparable to areas in the control site, significant differences in diurnal patterns were also observed with highest densities during daytime in both the impact and the control area (Figure 22), which also correspond to higher biomasses registered during daytime (Figure 23).

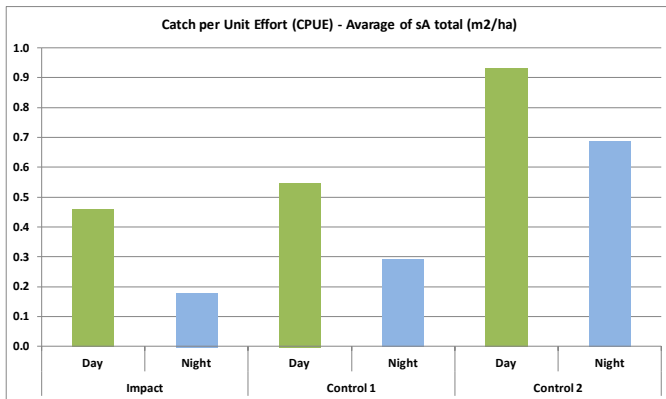

Figure 21. Total abundance and spatial distribution of pelagic (PEL) and demersal fish (DEM) except sandeels measured by acoustic average CPUE's for both vertical and horizontal surveys in the impact and control area.

Although, high spatial variation in abundance pattern was observed in the horizontal hydro-acoustic surveys, covering turbine foundations in the impact area, a typical day–night migration was observed. In daytime higher abundance and biomass was observed inside or close to the impact area compared to the control area outside the wind farm, whereas during night the opposite distribution pattern was observed (Figure 24 and Figure 25). Although, in lower abundances, higher relative proportion of day catches in the vertical surveys was also observed in the impact area compared

to the control area (Figure 26). In 2005 however, higher abundances and biomass were observed inside the impact area during night compared to daytime.

Fish are normally oriented parallel to the main current direction, which in the Horns Reef area is north-south, but no significant differences in the acoustic signals were found between the survey lines in north-south and the east-west direction although, higher variation and higher abundances inside the impact area was registered north-south. In the control area higher variation was observed oriented in the east-western direction.



Schematic illustration of horizontal echo beam.

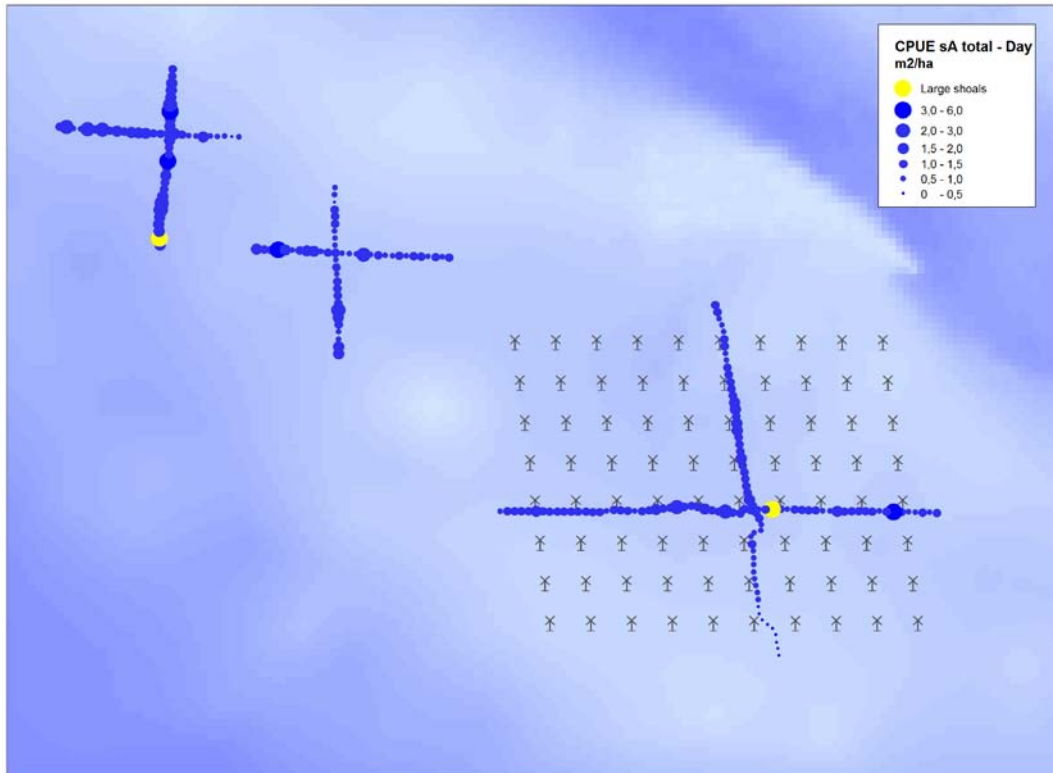

Figure 22. Biomass distribution pattern (CPUE sA) in day time of pelagic and demersal fish in the impact and control area September 2009, vertical hydroacoustic survey

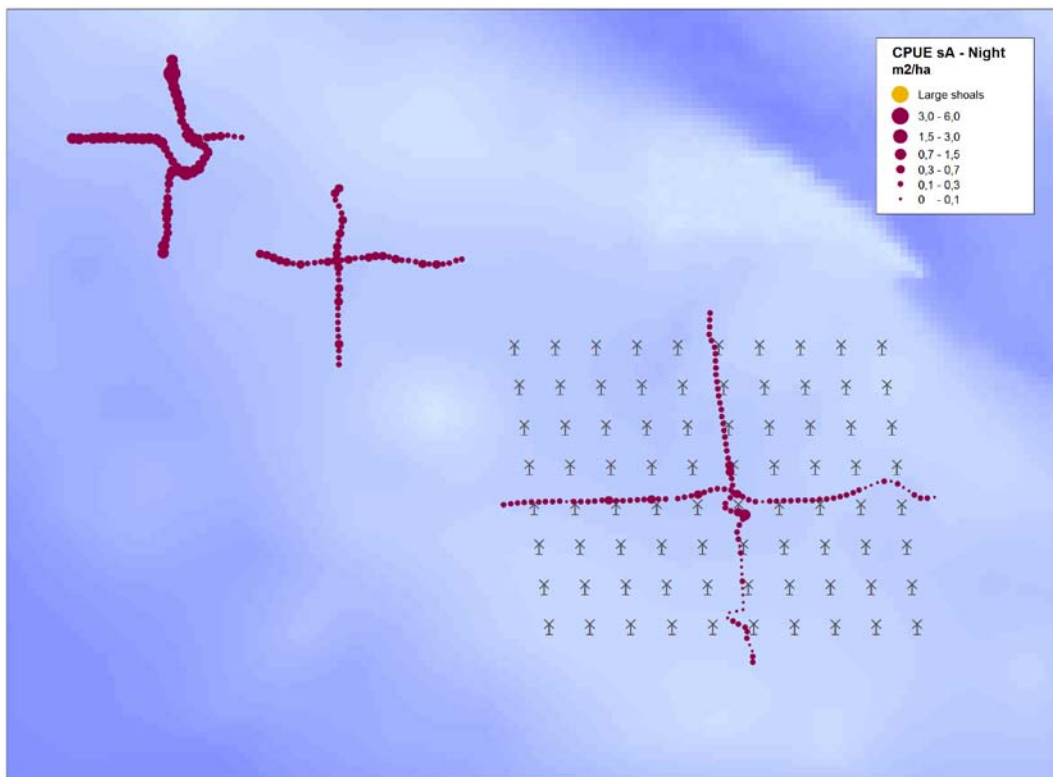

Figure 23. Biomass distribution pattern (CPUE sA) at night of pelagic and demersal fish in the impact and control area September 2009, vertical hydroacoustic survey.

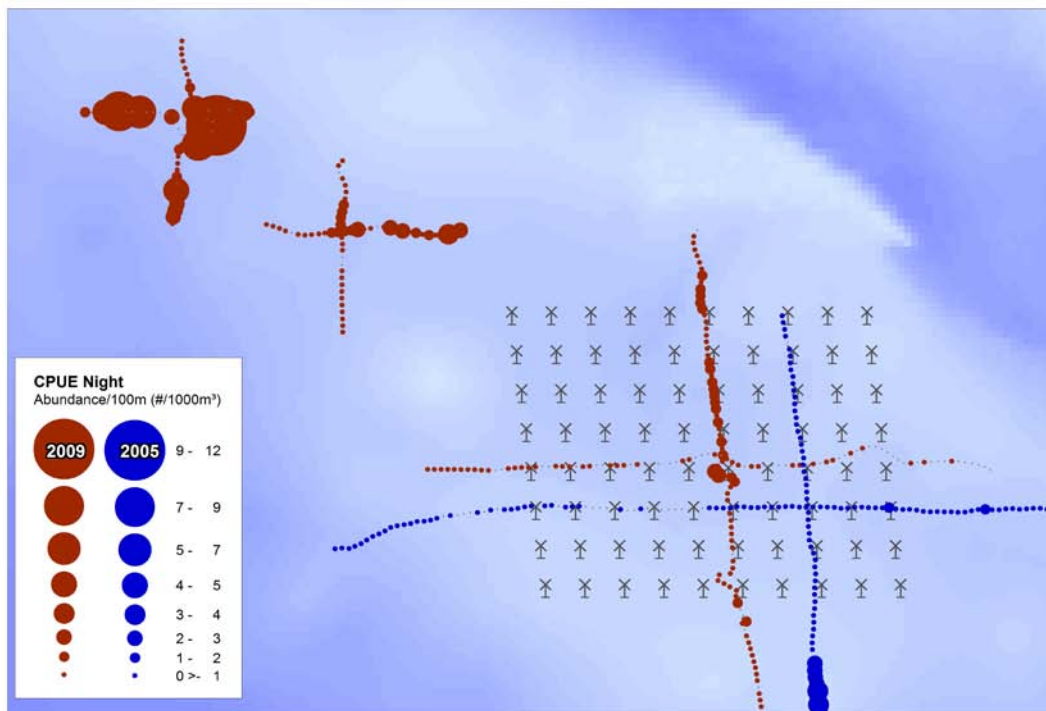
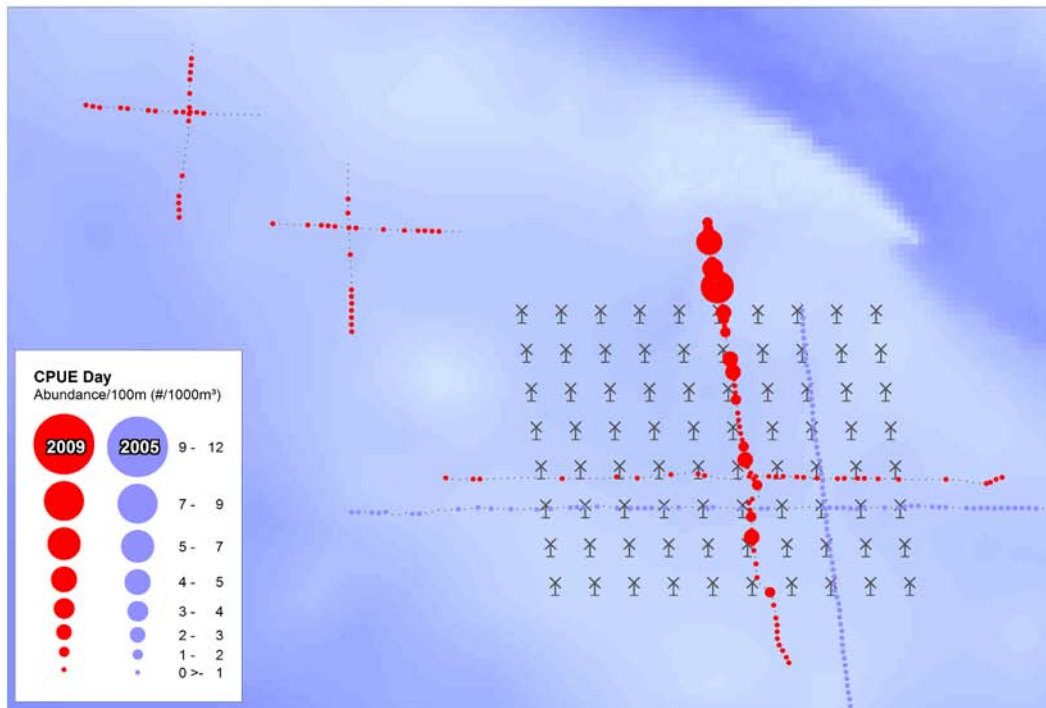

Figure 24. Abundance distribution pattern of pelagic and demersal fish in the impact and control area September 2005 and 2009, horizontal hydroacoustic survey

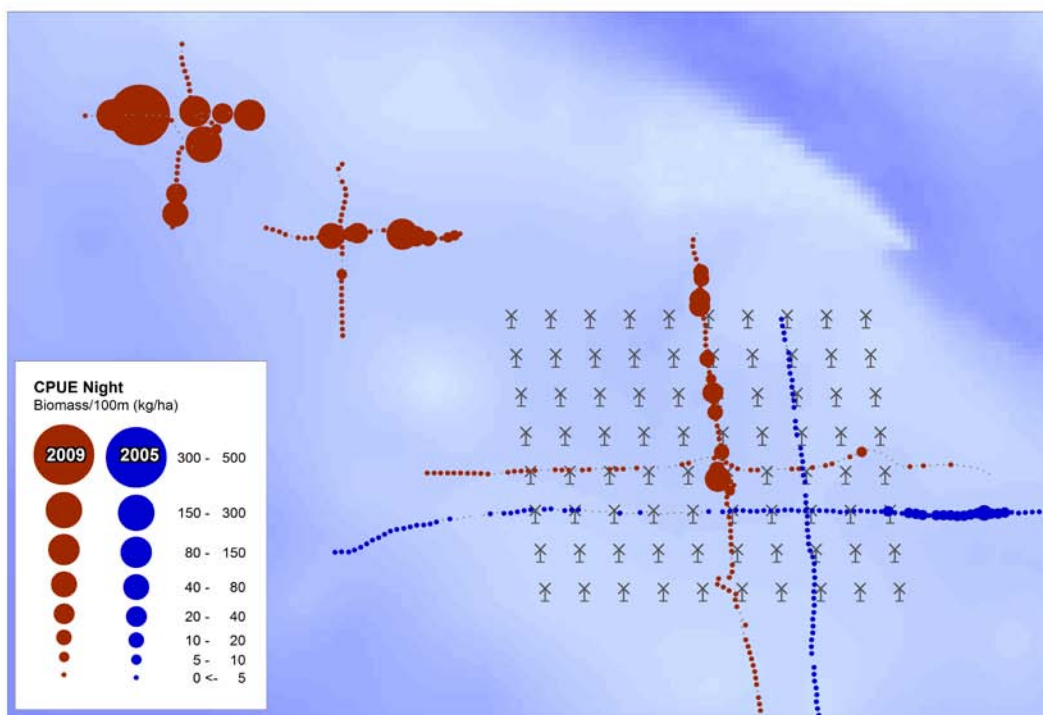
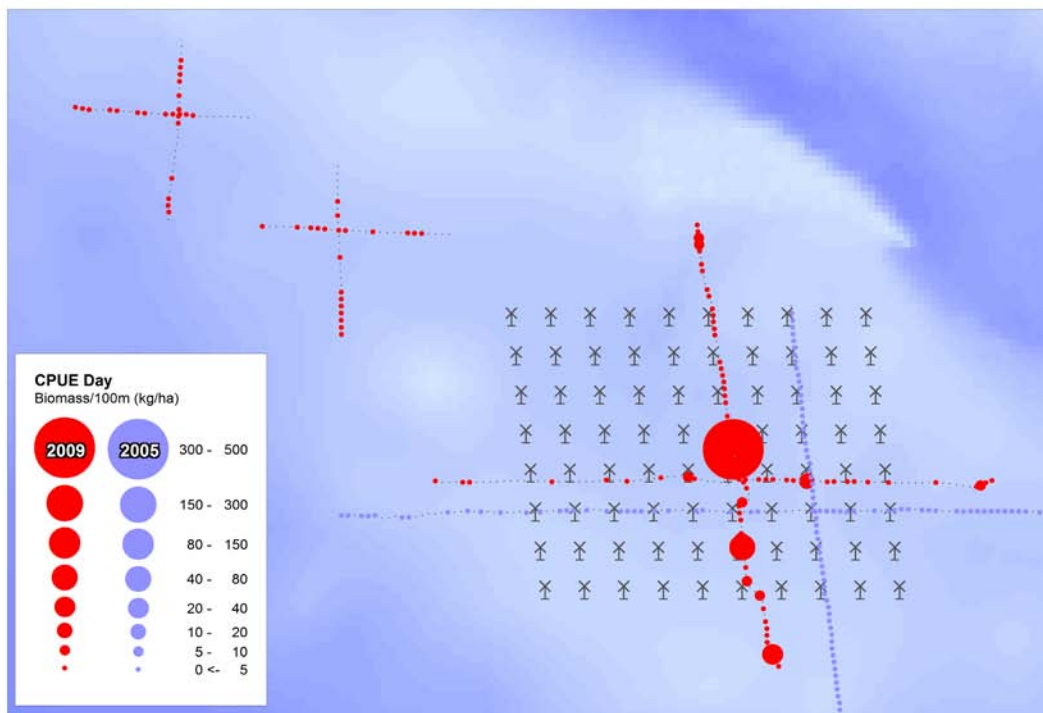

Figure 25. Biomass distribution pattern of pelagic and demersal fish in the impact and control area September 2005 and 2009, horizontal hydroacoustic survey.

Catch per Unit Effort (CPUE) sA total (m2/ha)			
Area/time	Count/100 m	Average sA	StdDev sA
<b>Impact</b>			
Day	116	0.459	0.414
Night	123	0.180	0.101
<b>Control 1</b>			
Day	52	0.548	0.644
Night	58	0.292	0.073
<b>Control 2</b>			
Day	51	0.930	0.805
Night	72	0.686	0.628

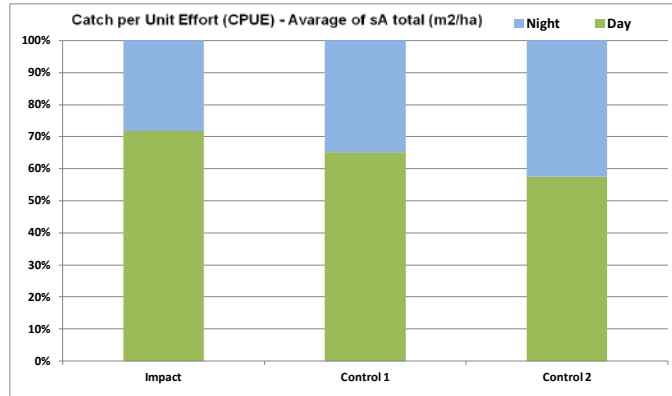

Figure 26. Relative abundance and spatial distribution of pelagic (PEL) and demersal fish (DEM) except sandeels measured by acoustic average CPUE's in the impact and control area, vertical hydroacoustic survey.

Analysing the survey data in the impact area for 2005 and 2009 significant cross effects were found (Figure 27), (Appendix X). By split in direction significant differences in abundance were found between years analysing the east-west transect data showing higher densities in 2005 compared to 2009 ( $p < 0.015$ ), and in the day and night distribution ( $p < 0.001$ ) showing higher abundances during night, which do not correspond with the general observation (Figure 21).

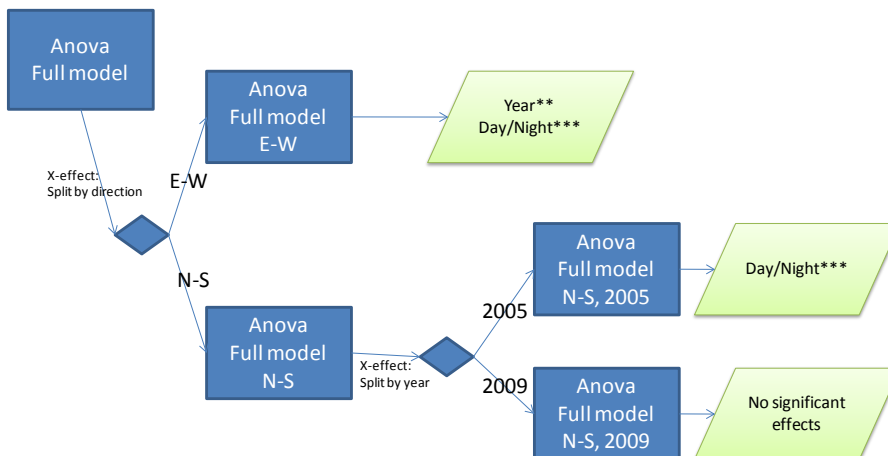

Figure 27. ANOVA chart flow for analysing differences in acoustic transect data for 2005 and 2009 inside the impact area.

Significant cross effects were found analysing the north-south transect data and significant differences between day and night was only found when analysing the 2005 data ( $p < 0.000$ ). Although no significant differences were found between 2005 and 2009 apparently higher abundances along the north-south transect were observed especially during daytime (Figure 24).

### 3.1.3 Distribution in relation to distance from turbine foundations

Although, not statistical significant ( $p=0.059$ ), analyses of fish distributions on distance (*near, mid, far* away) from turbines performed on all fish groups, showed a tendency for higher catch rates near the turbines (Figure 28) of reef associated fish species (ROC) in autumn surveys. For the other groups and in the spring survey there was no tendency or significant effect of distance ( $p > 0.14$ ) (Figure 28). Nor, by analysing the acoustic data effects of presence of turbines were detected within a distance of 100 m from the turbines (Appendix X).



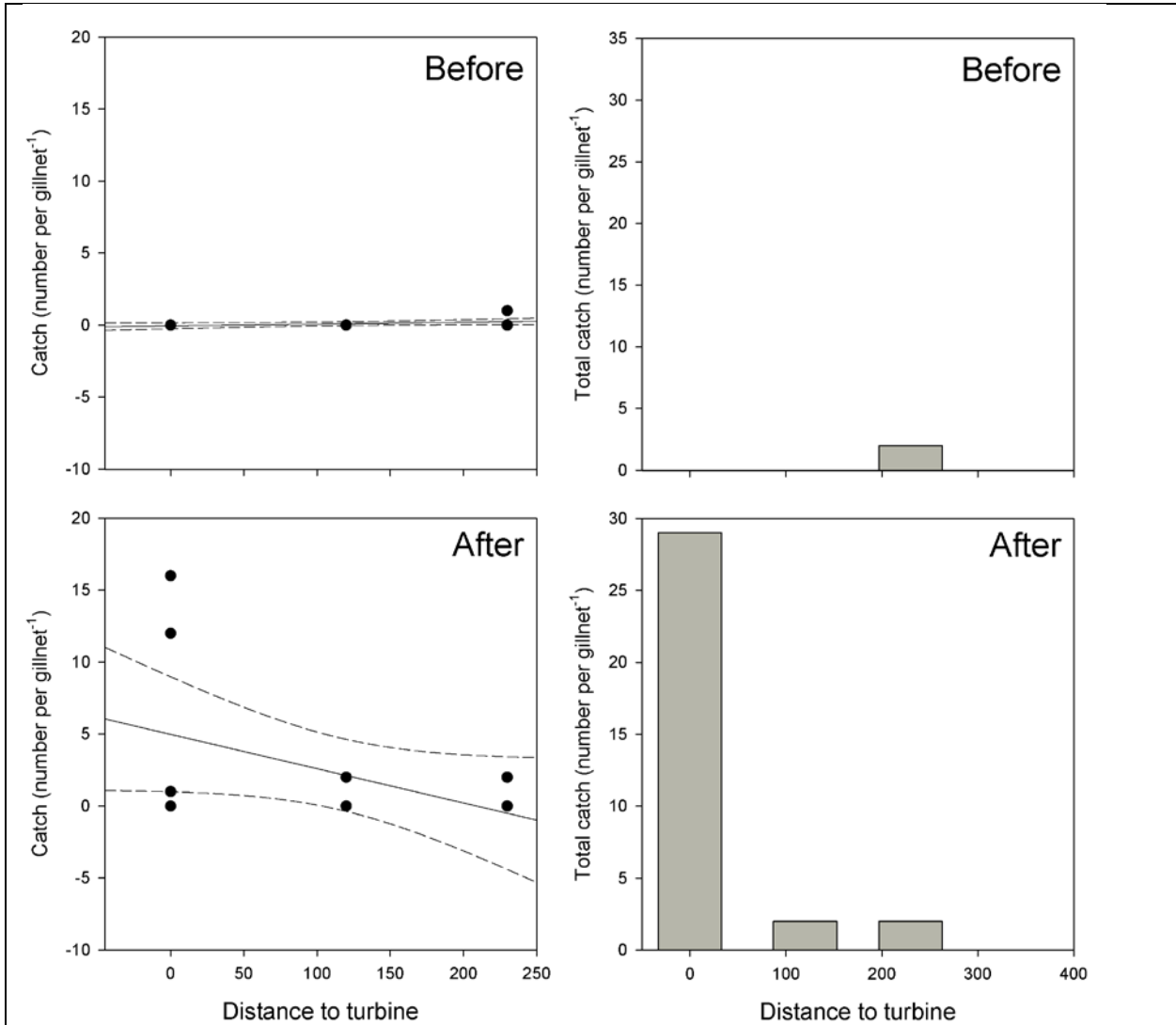

Figure 28. Average standardized catch rate ( $\log_{10} N$ ) in the autumn survey Before-After on reef habitat fish species (ROC). Left: Average catch in individual gillnet with 95% confidence interval (CI) included. Right: Total cumulated catch.

### 3.2 SANDEEL ASSEMBLAGES

All four species of sandeel found in the North Sea - *lesser sandeel* (*Ammodytes marinus*), *small sandeel* (*Ammodytes tobianus*), *greater sandeel* (*Hyperoplus lanceolatus*) and *smooth sandeel* (*Gymnammodytes semisquamatus*) were encountered from the Horns Reef area during the surveys. *Greater sandeel* was by far the most frequent and abundant species (Table 10) whereas the *smooth sandeel* was only sporadically encountered.

Table 10. Number of sandeels in samples. Greater sandeel (*Hyperolus lanceolatus* (H. l.)); lesser sandeel (*Ammodytes marinus* (A. m.)); small sandeel (*Ammodytes tobianus* (A. t.)); Impact area (I); Control area (C). Only late March 2010 is included for individual species and adult/juvenile. Numbers in parenthesis refer to the numbers of sandeels caught during the replicate survey. Numbers in brackets refer to the number of samples and 2x and 3x refer to the number of replicate surveys.

Year	Area	Adults			Juveniles			Total
		H. l.	A. m.	A. t.	H. l.	A. m.	A. t.	
2002	I [44]	27	49	38	215	64	9	402
	C [15]	15	24	9	55	30	5	138
2004	I [28]	128	3	14	277	3	7	432
	C [20]	40	2	3	68	1	1	115
2009	I [2x12]	21	10	36	125	0	2	194(557)
	C [2x12]	59	7	12	133	0	0	211(536)
2010	I [3x10]	2	3	6	21	1	1	34 (36)
	C [3x10]	4	6	14	56	9	1	90 (96)
Total		296	104	132	950	108	26	1,616(1,229)

Overall catches of the most abundant species of sandeels varied only slightly from year to year, except for March 2010 where catch rates were notably lower than in the preceding years (Figure 29).

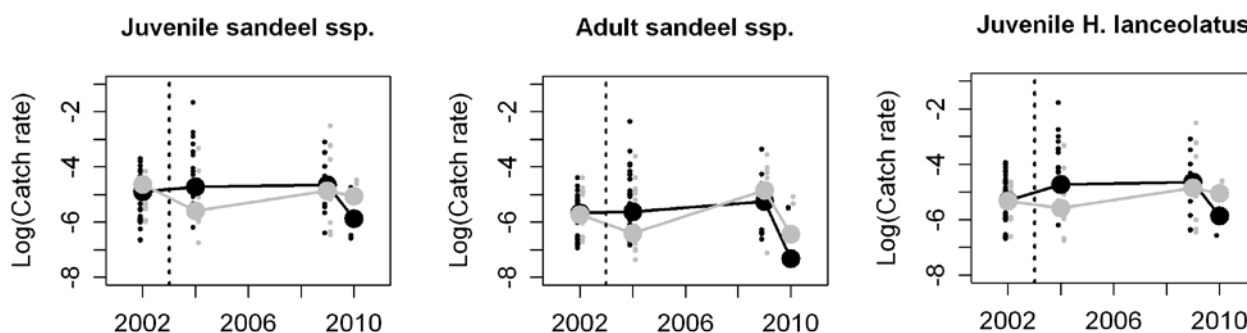

Figure 29. Comparison of catch rates in the impact area versus the control area (black: Impact area; grey: Control area) for each survey year. On the y-axis are the log-transformed catch rates (numbers per meter dredged). Juvenile sandeel ssp., adult sandeel ssp. and juvenile greater sandeel (*Hyperolus lanceolatus*) are presented in separate panels. Each small dot represents one sample haul. Large dots depict the median values. Broken vertical line represents the time of wind farm construction. Only data from late March 2010 is included.

Juveniles of *greater sandeel* dominated the sandeel community in all years, within both the impact and control areas. *Lesser sandeel* was relatively more abundant than *small sandeel* in March 2002 in both the control and impact areas, but became exceedingly rare in both areas after 2002 (Table 10). Juveniles of *lesser sandeel* and *small sandeel* were rarer than adults in both areas after 2002.

Samples from early, mid and late March showed a steady increase in the occurrence of juvenile sandeels throughout March 2010, ( $P < 0.001$ ) with nearly all samples consisting of juvenile sandeels by late March 2010. By late March 2010, the occurrence of sandeels had reached a level comparable to that of September 2009.

This pattern was equally evident in the control area and impact area (Figure 30). Due to the notable seasonal effect detected among the three surveys in March 2010 further analyses only included data from the late March survey.

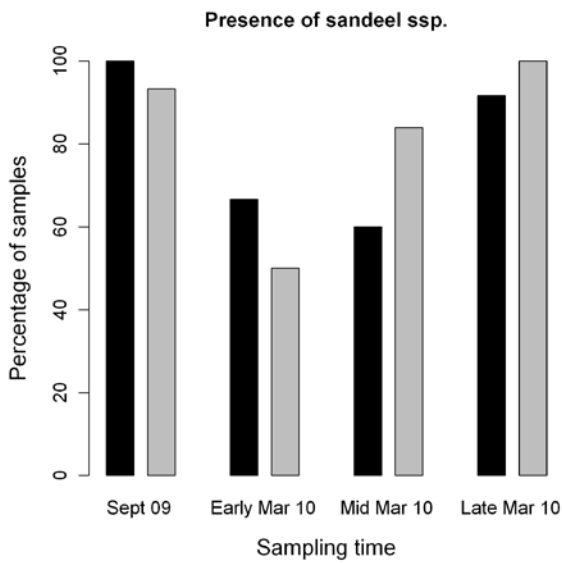

Figure 30. Seasonal effects on the percentage of samples containing one or more fish (occurrence) (all species and sizes combined). Y-axis: Percentage of samples containing one or more fish. Impact area: Black bars; Control area: Grey bars.

### 3.2.1 Day and night patterns

It was found in September 2009 that observed densities, as measured by dredging, depends on time of day (Figure 31). Generally, more fish were caught buried in the seabed as the day progressed into night. This pattern was similar for all species except *smooth sandeel* which was only recorded in low numbers.

The day/night effect assessed during the September 2009 survey was tested highly significant ( $p < 0.001$ ), with night time catch rates being roughly 3 times higher than day time catch rates (Figure 32).

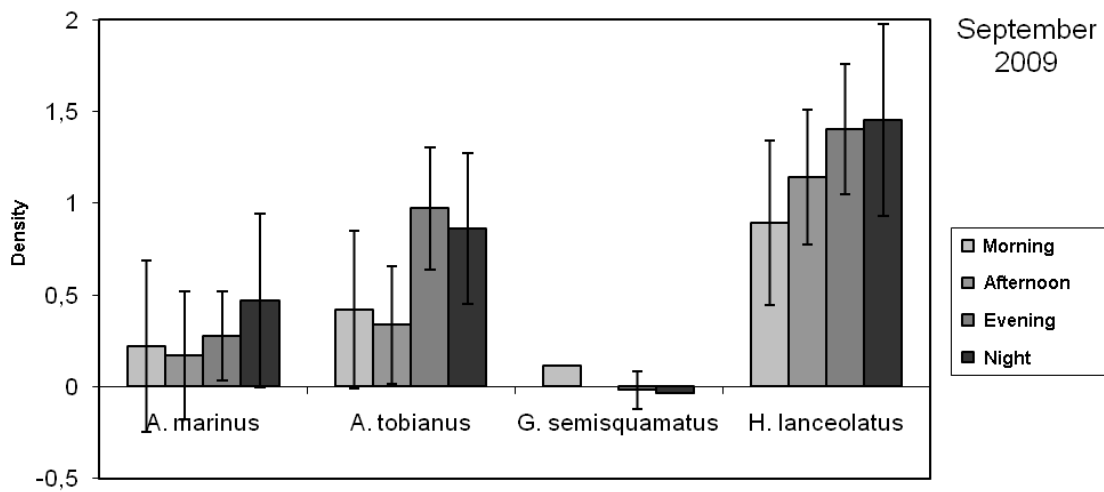

Figure 31. Time of day/Density of fish. Density refers to number of sandeels / 1,000 m<sup>2</sup>, greater sandeel (*Hyperolus lanceolatus*); lesser sandeel (*Ammodytes marinus*); small sandeel (*Ammodytes tobianus*) and smooth sandeel (*Gymnammodytes semisquamatus*).

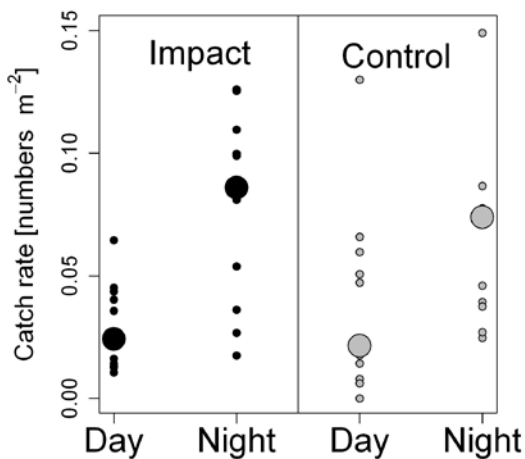

Figure 32. Day/Night effect on sandeel catchability in the impact area (black) and control area (grey), respectively. On the y-axis are catch rates (numbers of sandeel ssp. per  $m^2$  dredged; derived directly from prevalence). Each small dot represents one sample haul. Large dots depict the median values.

### 3.2.2 Age

Age of sandeels can be measured as length (Appendix VI), and there was an apparent difference in the length distribution between the impact and control areas in 2004 where the most frequent combined length group in the impact area was c. 2 cm smaller than in the control area (Figure 33).

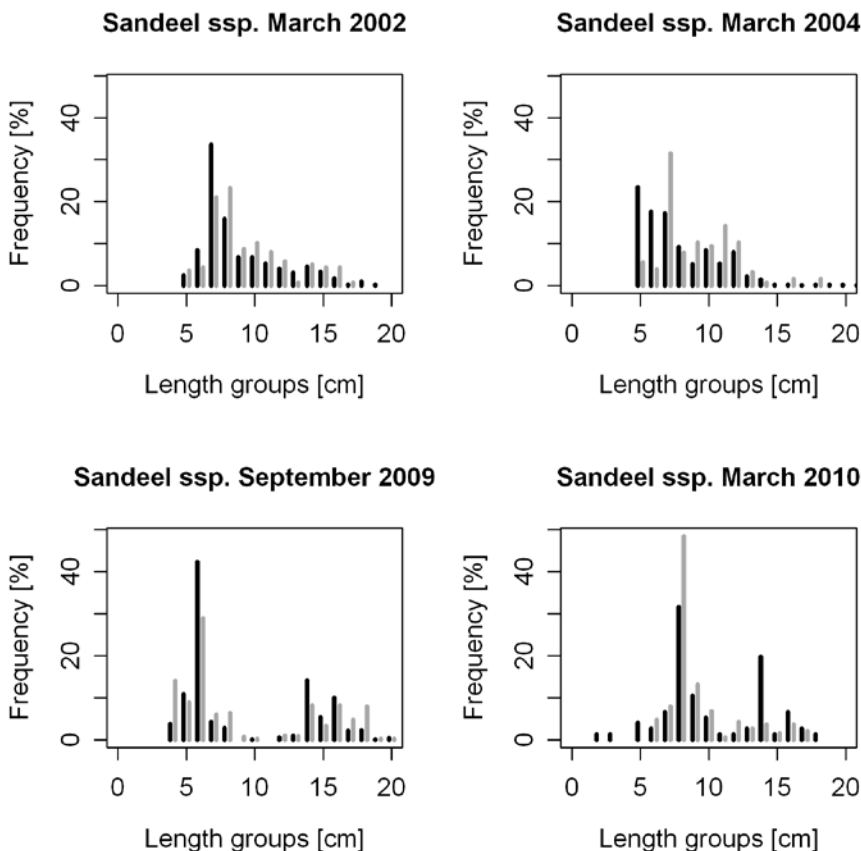

Figure 33. Combined relative length distribution of sandeels. Red bars refer to the control area. Black bars refer to the impact area.

The length distribution in the impact area was heavily skewed which presumably reflected an abundant presence of smaller sandeels below 5 cm not sampled by the dredge due to the mesh size used. The

combined length distribution mainly reflects the length groups of the most abundant *greater sandeel* (Figure 34) for which the mean length of small *greater sandeel* (0-10 cm) in 2004 was significantly smaller in the impact area compared to the control area ( $p < 0.01$ ).

The frequency of fish decreased gradually with increasing size in 2002 and 2004, whereas a bimodal length distribution was more evident in 2009 and 2010 (Figure 33) representing two or three age classes. Small fish were most abundant, but the majority of combined species length was 5–10 cm, indicating the development of sandeels had past the juvenile stage. However, the majority (> 80%) of all individuals of *greater sandeel* were less than one year old (age class 0) (Figure 35). In 2010 older specimens of *lesser sandeel* in age class 1 were approximately equally abundant as fish in age class 0 (c. 35 %) and nearly 20% were older than one year. This age distribution for *lesser sandeel* was significantly ( $p < 0.01$ ) different from 2002 where almost all specimens were less than one year old (Figure 35).

The difference and increase in length distribution from September 2009, where the mean length of smaller specimens of *greater sandeel* (0–10 cm) was significant lower than in all other years ( $p < 0.001$ ), to March 2010, is due to the growth of the sandeels. However, no significant differences in the age distribution between years were detected nor were there any significant difference detected between the impact and control areas in any of the surveyed years.

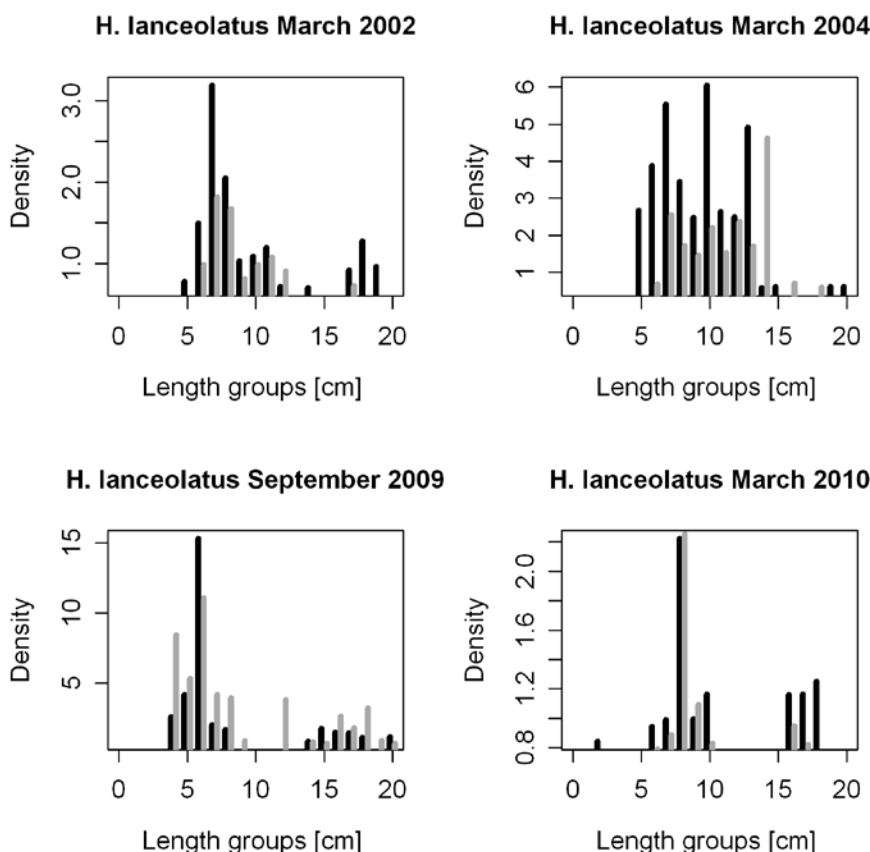

Figure 34. Length distribution for greater sandeel (*Hyperoplus lanceolatus*). Red bars refer to the control area. Black bars refer to the impact area.

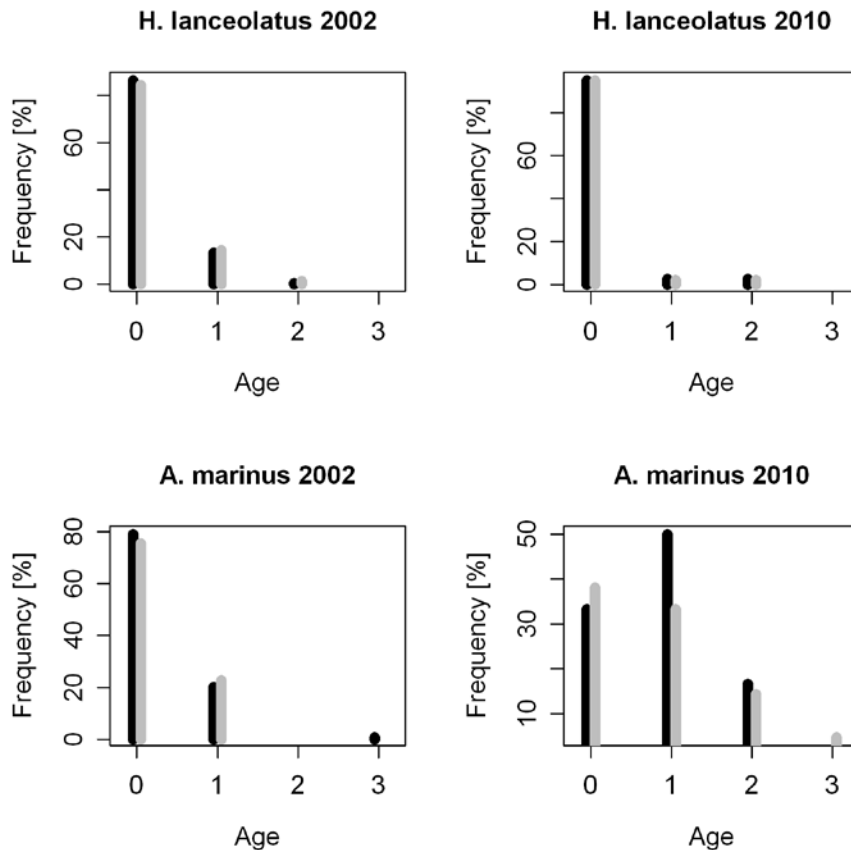

Figure 35. Age distribution for greater sandeel (*Hyperoplus lanceolatus*) and lesser sandeel (*Ammodytes marinus*) in 2002 and 2010. Red bars refer to the control area. Black bars refer to the impact area.

The relative length distribution of *lesser sandeel* and *small sandeel* contributed only insignificantly to the overall length distribution, although smaller individuals of *lesser sandeel* also dominated in March 2004 (Appendix VI, Appendix figure 1 and Appendix figure 2).

### 3.2.3 Drift-simulation of *greater sandeel* and *lesser sandeel*

In order to evaluate the importance of Horns Reef as a spawning or nursery ground for sandeels in the area or in the North Sea a larva drift-simulation model was set up and run. The model predicts if there is a self-reproductive population of sandeels in the Horns Reef area or the population of different sandeel species is dependent on influx of larvae or is exposed to a net outflux of larvae.

The model simulated the passive drift of 100,000 *greater sandeel* larvae by the sea currents from Horns Rev during the 15<sup>th</sup> May ( $\pm 12$  days) to the 5<sup>th</sup> July ( $\pm 8$  days) 2005. The model showed that the larvae remained in the Horns Reef area where they metamorphosed (changed from larvae to juvenile (Appendix VI)) (Figure 36). By calculating the larvae drift patterns in the same year and period, the data showed that the larvae came from the same small area north of Horns Rev. In 2006, within the same time period, the model demonstrated that by allowing the *greater sandeel* larvae to drift with the current, the larvae metamorphosed in an area along the west coast and through Skagerrak. In the same year and period, the model showed that by simulating backward drift, fish from Horns Rev could be traced back to where they hatched. The place of origin was tracked down to Horns Rev and a smaller area southwest of Horns Rev.

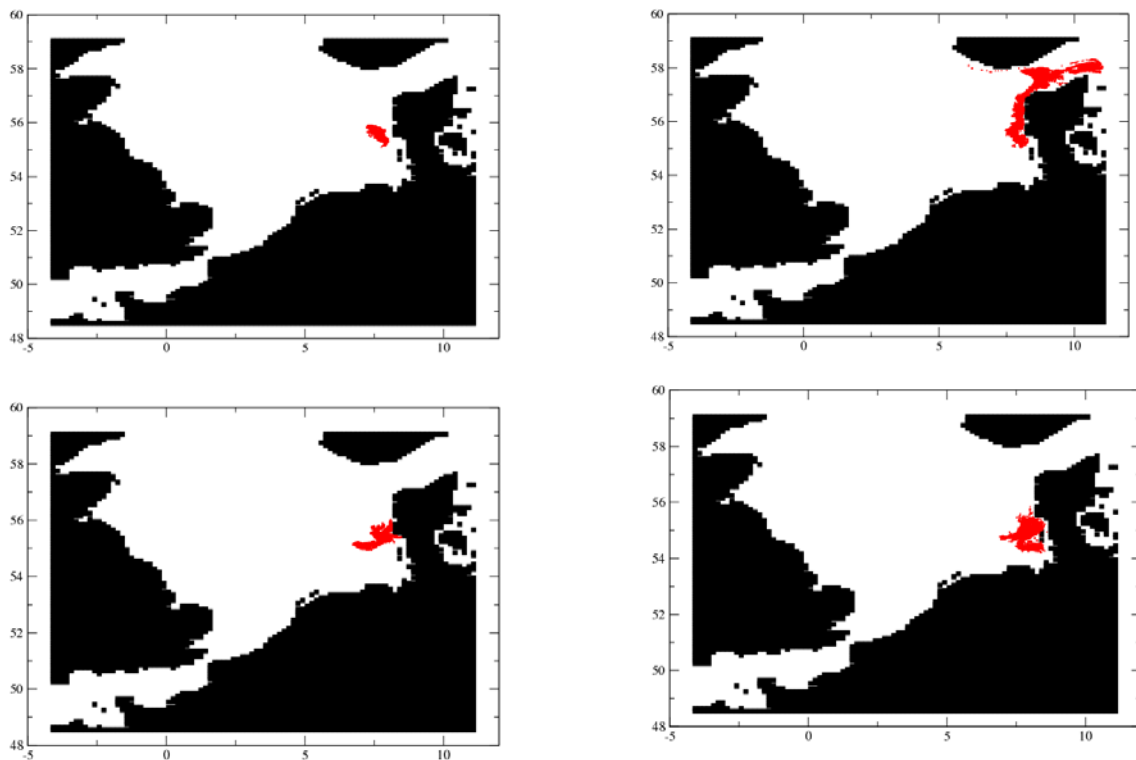

Figure 36. Upper left: Forward simulation for greater sandeel 2005; Upper right: Forward simulation for greater sandeel 2006; Lower left: Backward simulation for greater sandeel 2005; Lower right: Backward simulation for greater sandeel 2006.

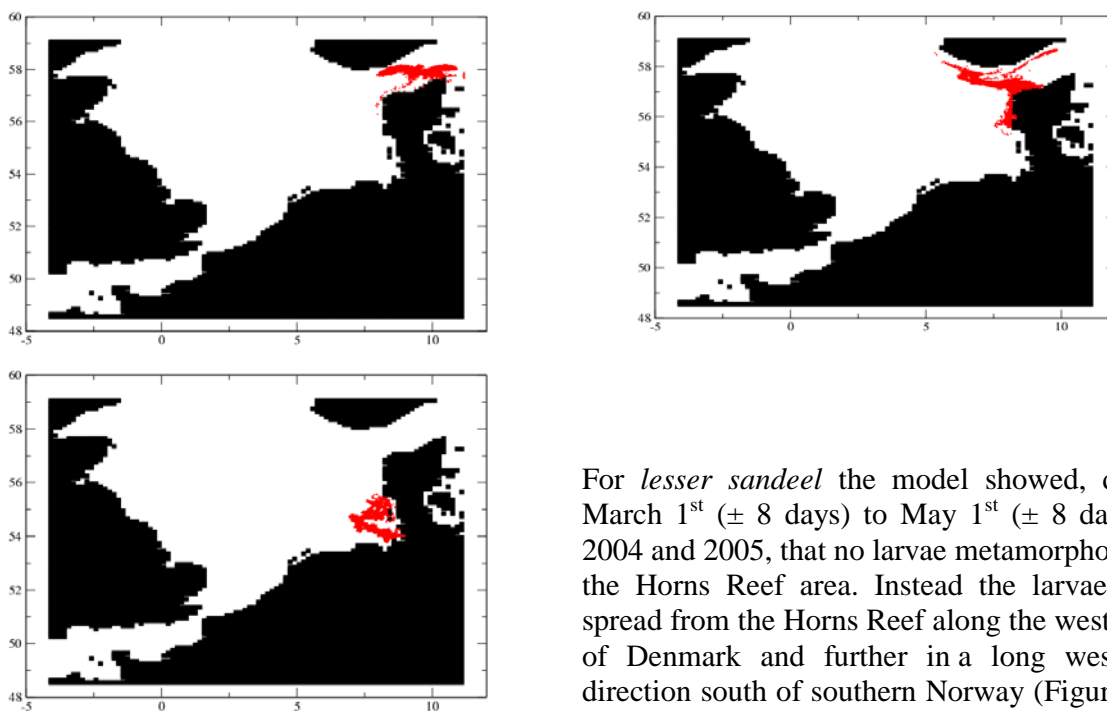

Figure 37. Upper left: Forward simulation for lesser sandeel 2004; Upper right: Forward simulation for lesser sandeel 2005; Lower left: Backward simulation for lesser sandeel 2004.

For *lesser sandeel* the model showed, during March 1<sup>st</sup> ( $\pm 8$  days) to May 1<sup>st</sup> ( $\pm 8$  days) in 2004 and 2005, that no larvae metamorphosed in the Horns Reef area. Instead the larvae were spread from the Horns Reef along the west coast of Denmark and further in a long westward direction south of southern Norway (Figure 37). For the same period the model showed that the metamorphosed larvae at Horns Reef originated from another area immediately south of Horns Rev down to the German Bight.

In 2006 it was found that *lesser sandeel* larvae transported from the Horns Rev mainly metamorphosed in Skagerrak.

### 3.2.4 Sediment quality

The sediment consisted mainly of medium coarse sand (0.3-0.5 mm) and the frequency of grain sizes appears to follow a normal distribution in all years with the exception of a second peak in frequency of coarser sediment (> 4 mm, gravel) within the impact area in 2002 and 2004; the most pronounced of which occurred in 2004 (Figure 38). Furthermore, in both 2004 and 2010, grain sizes between 0.1 mm and 0.2 mm (fine sand) were more frequent in the control area. This pattern was absent in 2002 and 2009.

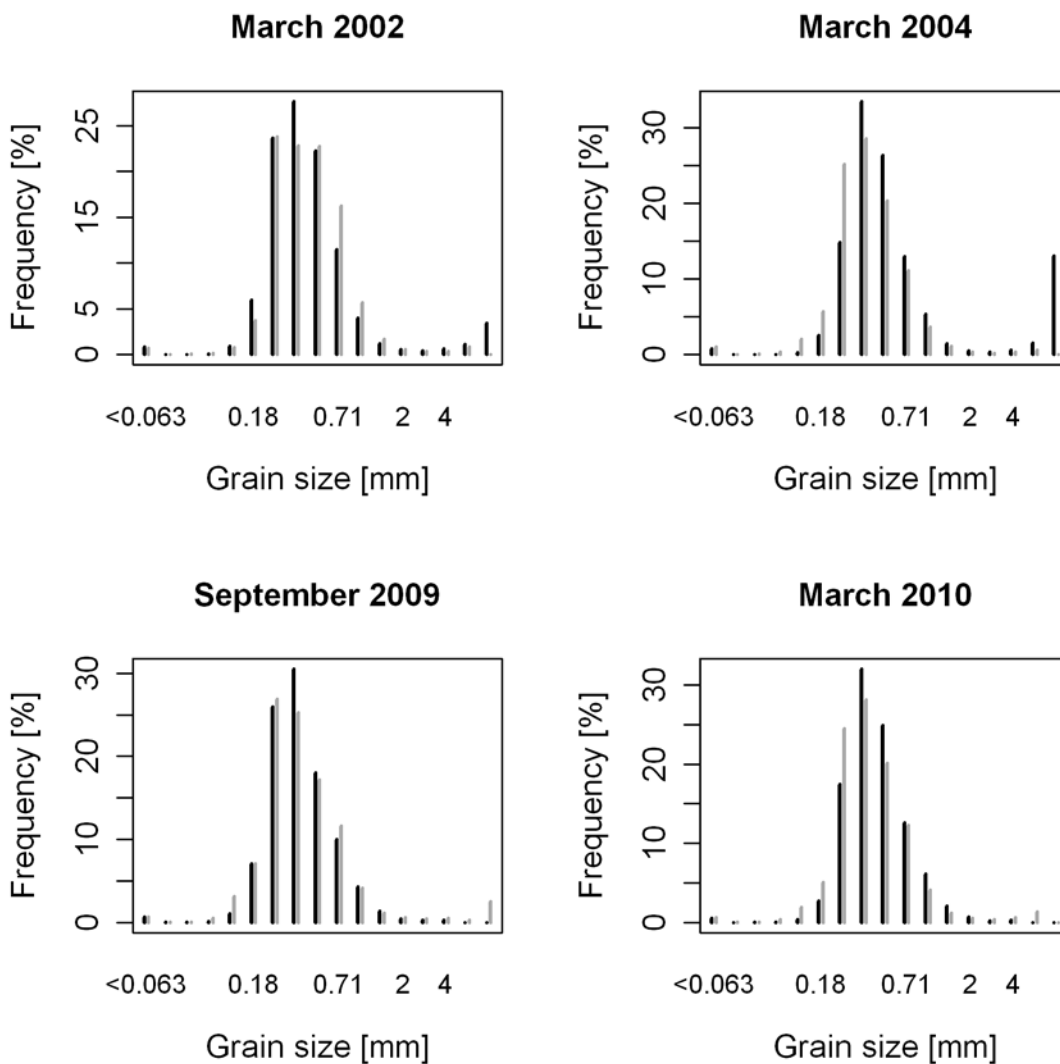

Figure 38. Relative weight fractions of sediment samples distributed into size-classes for each survey year. Black bars refer to the impact area.

The mean weight fraction of silt+clay (particles <0.09 mm) was below 1.2% in all years in both areas and as such suitable habitats for sandeels. Variation in the weight fraction of silt+clay among samples was small, and all samples were below 1.8% (Appendix IX).



### 3.2.5 Species distribution modelling

The species distribution model could not be used for predicting the spatial distribution of sandeels as it produced infinitive values, it could in other words not explain the distribution of the sandeels for the whole region based on modelled relationships.

The species distribution model based on the data from 2002 before establishment of the wind farm had a low deviance explained, which means most of the variance in the data could not be explained by the environmental variables used (Appendix IX). The deviance explained in the model based on data after the construction of the wind farm (2004, 2009 and 2010) had a higher deviance, explained than the model based on data from 2002, but the model is probably over fitted (the response curves follows the data too closely (Appendix IX)). When simplifying the curves the deviance dropped quickly.

### 3.2.6 Wind farm impact on the sandeel community

Model 1 was used to test the null-hypothesis for sandeel ssp. (all species combined), adults and juveniles, respectively, and for juvenile *greater sandeel*. However, numbers of adult *greater sandeel*, *lesser sandeel* and *small sandeel* per sample were, in general, small and the frequency of samples in which these were absent was high (null-samples). Therefore, model 2 was applied to test the null-hypothesis for adult *greater sandeel*, *small sandeel* and *lesser sandeel*. The number of observations of juvenile *small sandeel* and *lesser sandeel* were too sparse to support a meaningful test.

In March 2002 before construction of the wind farm there were no significant differences in the number or occurrence of sandeels between the impact and control area, nor was there any overall indication of differences between the areas (Table 11, Table 12 and Figure 39). Hence the numbers of sandeels did not differ between the impact and control area and the null-hypothesis could not be rejected.

Table 11. Testing the null-hypothesis using model 1. Impact area (I); Control area (C). †: marginally significant; \*: significant, \*\*\*: highly significant. Greater sandeel (*Hyperolus lanceolatus*).

	Mar 2002 C vs I	Mar 2004 C vs I	Sept 2009 C vs I	Mar 2010 C vs I
Juvenile sandeel ssp.	P = 0.52	P < 0.001***	P = 0.56	P = 0.11
Adult sandeel ssp.	P = 0.56	P < 0.01*	P = 0.47	P = 0.31
Juvenile <i>H. lanceolatus</i>	P = 0.23	P < 0.001***	P = 0.50	P = 0.17

Table 12. Testing the null-hypothesis using model 2. Impact area (I); Control area (C). For adult lesser sandeel the proportion of null-samples were close to 100%, it was therefore not possible to conduct a meaningful test. Greater sandeel (*Hyperolus lanceolatus*); lesser sandeel (*Ammodytes marinus*) and small sandeel (*Ammodytes tobianus*).

	Mar 2002 C vs I	Mar 2004 C vs I	Sept 2009 C vs I	Mar 2010 C vs I
Adult <i>A. marinus</i>	P = 0.45	-	-	-
Adult <i>A. tobianus</i>	P = 0.08†	P = 0.04*	P = 0.69	P = 0.90
Adult <i>H. lanceolatus</i>	P = 0.21	P = 0.08†	P = 0.28	P = 0.23

In March 2004 after the construction of the wind farm juvenile and adult sandeels was significantly more abundant in the impact area compared to the control, which lead to a highly significant rejection of the null-hypothesis – there was a difference between the two sites. At the species level, this pattern was

highly significantly reflected by juvenile *greater sandeel* and indicated (marginally significant) by adult *greater sandeel* and adult *small sandeel*, but not by adult *lesser sandeel* and adult sandeel ssp. (Table 11, Table 12 and Figure 39).

Data from September 2009 and late March 2010 revealed no significant differences between impact and control area. There was, however, an insignificant tendency toward higher numbers of sandeels in the control area in March 2010 (Figure 30), whereas the night time replicate of the September 2009 survey perfectly confirmed the lack of a difference between impact and control area (Figure 32).

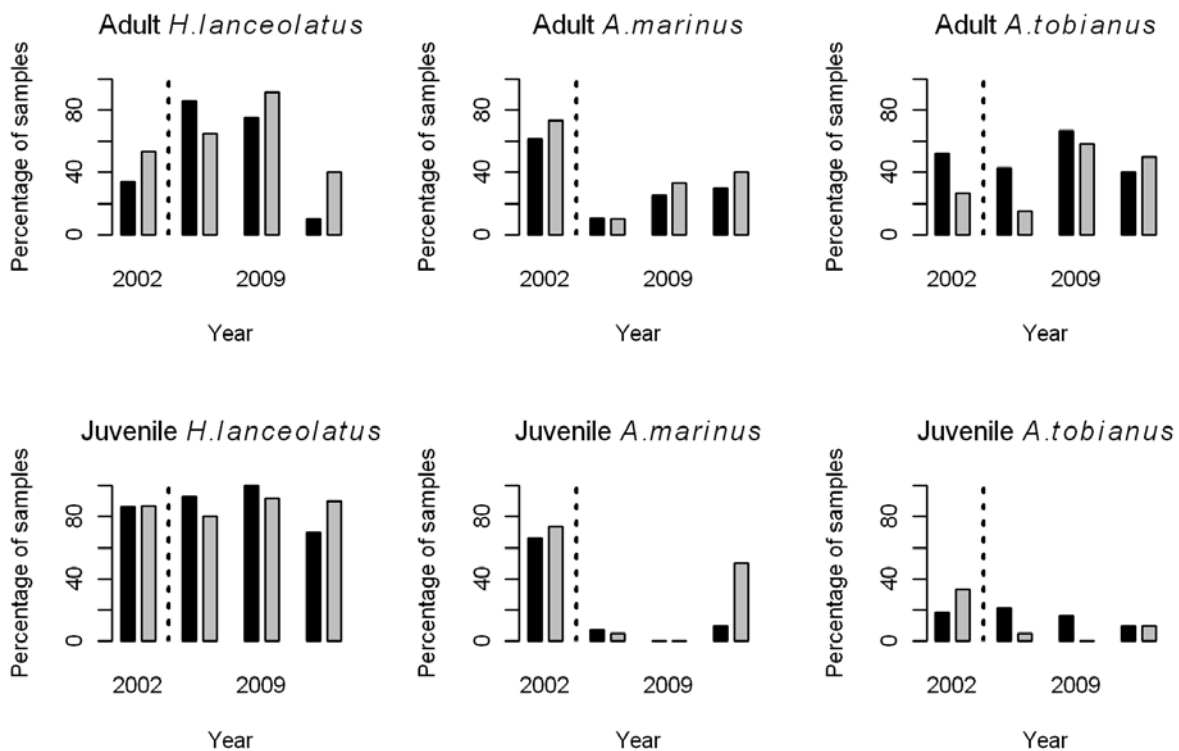

Figure 39. Percentage of samples containing one or more fish (occurrence), presented as impact (black) area versus control (grey) area for each survey year (2002, 2004, 2009 and 2010). Broken vertical line represents the time of wind farm construction. Only data from late March 2010 is included. Greater sandeel (*Hyperolus lanceolatus*), lesser sandeel (*Ammodytes marinus*) and small sandeel (*Ammodytes tobianus*).



Sandeel samples from Horns Reef. In the sample more sand gobies can be recognised and brown scrimps are numerous. One specimens of razor clam can also be identified.

## 4 Discussion

The fish communities in the relative shallow water at Horns Rev including the area of recently deployed large scale offshore wind farms display high spatial and temporal variability in distribution and occurrence which applies for both pelagic, demersal (bottom dwelling) and borrowing fish communities. This is a result of variations in environmental variables such as current, temperature and wave exposure.

In temperate waters, most juvenile fish migrate away from the shallow coastal areas in autumn and early winter in response to declining temperatures and return in the spring to feed in the warmer coastal waters, where food is abundant (Gibson, 1994). Sandeels are buried in the sand refuge areas during winter and emerge to the pelagic from the sea bed in the spring to feed (Reay, 1970).

An effect result of the unusually cold winter in 2009/2010 was found in the fish communities, including the sandeel community at Horns Rev in the spring surveys in 2010, which has biased the effect study. The water temperature in spring 2010 was considerably lower than in previous years (Table 13) affecting the fish occurrence and abundance. Thus the number of all fish species, including sandeel caught in the spring survey of 2010, was poor compared to previous surveys. Difference in fish abundance and diversity between autumn and spring surveys were also observed in the Dutch study (Hille Ris Lambers and ter Hofstede, 2009, Lindeboom et al., 2011). However, the difference in the Dutch study was not as evident as in our study, where the season effect seems to be further strengthened by the unusually cold winter and subsequent cold water temperature in spring 2010.

Table 13. Mean temperature Q1 February (from the ICES data base).

Year	Temperature	
	Bottom	Surface
2002	6.45	6.45
2003	3.94	3.89
2004	4.62	4.60
2005	5.76	5.74
2006	4.43	4.39
2007	6.64	6.63
2009	3.87	3.85
2010	2.39	2.13

The timing of the spring survey in early March in the present study therefore failed to capture the time when most fish had returned to the coast because of the persistent colder water temperatures. This is exemplified by dredge samples targeting sandeels from early, mid and late March 2010, which showed a steady increase in the occurrence of sandeels throughout March, and by late March 2010 the occurrence of sandeels had reached a level comparable to the other autumns and Before spring surveys.

Few studies on the effects of marine offshore wind farms on fish and faunal assemblages have utilised a BACI approach (Lindeboom, et al., 2011) mainly because such a field experimental design would need a project duration beyond that normally provided by funding agencies. In this case it was possible to perform a baseline study before the deployment of the wind farm and again seven years later. According to (Jensen, 2002), it takes around five years before stable faunal communities are established after deployment of artificial hard structures. Since the Impact study was conducted seven years after the deployment of the wind farm, it was assumed that a stable community was established. The study on short term effects in the offshore wind farm off the Dutch coast showed only minor and non-significant effects upon fish assemblages and abundances before-after the offshore wind farm was deployed (Hille Ris Lambers and ter Hofstede, 2009); (Lindeboom et al., 2011). The fish community still appeared to be highly dynamic both in time and space and thus in line with Jensen (2002) conclusion.

The BACI design of this study made it possible to compare fish assemblages Before and After the introduction of the Horns Rev 1 Offshore Wind Farm within (Impact) and outside (Control) the wind farm area and as such, is a unique study. In general impact of offshore constructions on adjacent soft-bottom fish communities are rare e.g. (Rilov and Benayahu, 1998; Wilhelmsson, *et al.*, 2006) and the studies at Horns Rev is the first to include long-term effects on fish communities from the deployment of a large scale offshore wind farm.

## 4.1 FISH COMMUNITY

The introduction of hard substrate with Horns Rev Offshore Wind Farm to the sand banks characteristic of the southern North Sea resulted in changes in the fish abundances and community and in species diversity. Fish redistributed from being generally more abundant in the Control area before the establishment of the offshore wind farm to more similar fish abundance in Impact and Control area seven years later. This change in distribution pattern may be attributed to the deployment of the offshore wind farm increasing the suitability of this area as a more diverse fish habitat. The results from the acoustic surveys furthermore indicate that there was a diurnal difference in fish distribution patterns with fish mainly being present in the impact area during the day while migrating to deeper waters north-western of the wind farm site in the night. Such diurnal shift in spatial distribution has also been observed in autumn for gadoids in a Dutch OWF (Winter et al. 2010), around ships wrecks (Karlsen, 2011) and for pelagic species that tend to travel between individual reefs and between a reef area and surrounding areas depending on for example their feeding capacity and differential use of habitat type (Bohnsack, 1989). This suggests that even though the impact area offers a more diverse habitat, fish are still utilising areas outside the wind farm either due to size constraints of the park area or that adjacent areas provide alternative services (prey, refuge, physics etc.) not found in the impact area.

In general, and in contrast to the hypothesis that wind farms would attract pelagic and demersal fish species to the farm area, fewer fish of the different fish species were caught in the windfarm area after deployment. However, it was also evident that abundance in the control area was similarly lower than before deployment suggesting larger-scale processes were affecting fish occurrence in that part of the North Sea. Pelagic fish populations fluctuate highly from year to year making it generally difficult in impact studies to examine large-scale population impacts. However, focusing on the most abundant species in the Before surveys; whiting, a general decline in this stock in the North Sea is observed during the period from 2001 to 2010 (Figure 40) (ICES, 2010). The decline in abundance of this species in the North Sea is consistent with the observed decline in our study and suggests that the lower catches, at least for this species, may be related to larger-scale processes at the stock/population level.

Besides the large scale trends in time or space, there is also a small scale effect of the single turbines. This was particularly clear with the increase in species diversity very close to the turbines. The increase in diversity was driven by occurrence of reef fishes as goldsinny wrasse (*Ctenolabrus rupestris*), viviparous eelpout (*Zoarces viviparus*) and lump sucker (*Cyclopterus lumpus*). The small spatial scale effects of wind turbines have also been reported from other studies (Wilhelmsson et al., 2006, Winter et al., 2010, Couperus et al., 2010). The significant increase in fish diversity closer to the wind turbines may reflect a diversification of feeding opportunity caused by the newly established epibiota (organisms living on the seafloor surface or attached to other organisms).

The importance of changes in available prey for fish distribution patterns has been pointed out by several studies (Jansson, et al., 1985; Buckley and Hueckel, 1985). Infauna habitats were replaced with epibenthic communities with the introduction of hard bottom substrate after the deployment of the Horns Rev 1 Offshore Wind Farm (Leonhard and Pedersen, 2006). The most dominant species observed was the tube-dwelling amphipod *Jassa marmorata* on the monopiles in the sublittoral zone to the scour protection, while blue mussels (*Mytilus edulis*) dominated in terms of biomass in the sublittoral zone. Amphipods and blue mussels are known to be important prey items for fish. For example pouting (*Trisopterus luscus*) caught around wind turbines in the Belgian part of the southern North Sea were feeding on amphipod *Jassa herdmani* (Reubens, et al., 2010) while the reef fish goldsinny wrasse (*Ctenolabrus rupestris*) at boulder reef in the Kattegat were feeding on blue mussels (Dahl, et al., 2009). Gobies are a treasured food source for several large piscivore fish such as cod and turbot (cod; Magnhagen, 1998, turbot; Sparrevohn and Støttrup, 2008). Hence, the near absence of gobies in this study may partly explain why no increase in abundance of larger fish species was observed in the wind farm area. Gobies have in other studies been shown to occur in higher densities in areas where blue

mussels were abundant (Jansson, *et al.*, 1985), on natural reefs (Dahl, *et al.*, 2009) and in the vicinity of wind turbine foundations (Wilhelmsson, *et al.*, 2006; Andersson and Öhman, 2010). The successful establishment of blue mussels in the sublittoral zone on the turbines of the Horns Rev 1 Offshore Wind Farm was therefore expected to aggregate high numbers of gobies, and therefore indirectly also larger predatory fish. One hypothesis could be that the prevailing hydrographical conditions in the study area may have impacted their habitat suitability. The Horns Rev Offshore Wind Farm is exposed to the prevailing westerly winds, average wave heights of between 1-1.5 m, current speeds of 0.7 to 1.5 ms<sup>-1</sup> and sand transport of a magnitude of 500,000 m<sup>3</sup> (Leonhard and Pedersen, 2006). Studies of turbot feeding ecology have suggested that gobies are absent from wave exposed open coastlines (Sparrevohn and Støttrup, 2008). The absence of an important fish prey may thus explain why no significant increase in abundance of larger pelagic and demersal species relative to the control area was found.

**Total Stock Biomass ('0 000 tonnes)**

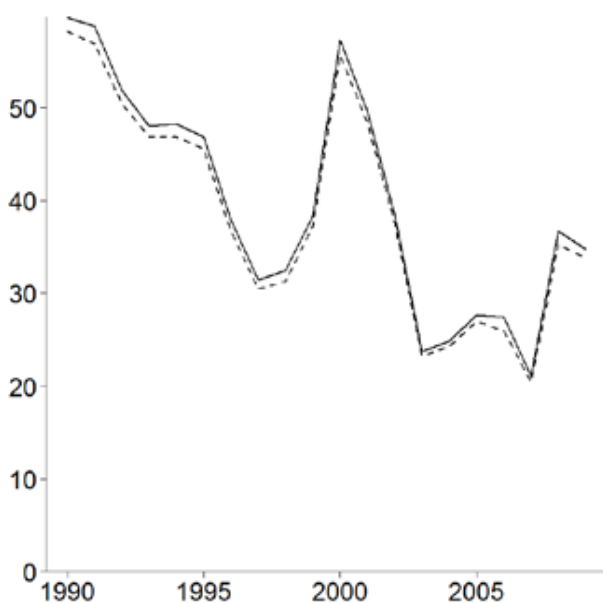

Figure 40. Whiting stock biomass in ICES areas IV and VIId from XSA assessment (redrawn from Figure 12.2.2 in Report of the Working Group on the Assessment of Demersal Stocks in the North Sea and Skagerrak (WGNSSK) (ICES, 2010).

distribution relative to the wind turbine structures on Horn Rev Offshore wind farm, apart from the reef habitat fishes, could be the lack of suitable fish prey such as gobies. However, the information from the above mentioned studies also indicate that the scale of fish distribution was on a much smaller spatial scale than that of the multi meshed gillnet used. The 110 m length of these gillnets integrated catches over this distance. The number of fish close to turbines and the effect of attraction might well be underestimated and our results must therefore be considered as providing conservative estimates. This view is supported by divers who have reported high fish densities immediately around structures at the Horns Rev 1 Offshore Wind Farm (pers. comm. Søren Larsen, Ulrik Westphal, Jens Christensen and Rune Frederiksen).

In other studies on effects on offshore constructions it has been shown that larger predatory species (e.g. saithe and cod) often aggregate around oil platforms (Løkkeborg, *et al.*, 2002) (Soldal, *et al.*, 2002) while higher residence time for cod near the turbines at a offshore wind farms in the southern North Sea off Holland Winter *et al.* (2010). From the same wind farm Couperus *et al.* (2010) presented acoustic qualitative results that indicated that mackerel (*Scomber scombrus* and *Trachurus trachurus*) and cod concentrations around the turbines could be much higher within the first 15 – 20 meters. This small scale difference in fish abundance have been observed in a wind farm in the Baltic where Wilhelmsson *et al.* (2006) reported much higher concentrations of gobies within 5 m distance from the turbine. As discussed earlier, the reason for the lack of clear spatial pattern in fish



Horse mackerel. Photo: Line Reeh.

## 4.2 SANDEEL ASSEMBLAGES

The results of the sandeel study indicated that construction of off-shore wind farms may affect sandeels in the impact area positively in the short term (one year after the construction), but in the longer term (7 years after construction) there was no detectable effect. This result is in line with the result of Lindeboom *et al.* (2011) from studies on impacts on fish from an offshore wind farm in the Dutch coastal zone roughly 500 km south-west of Horns Rev I. Their limited results regarding sandeels indicated that construction of offshore wind farms may affect overall abundance of sandeels in the impact area positively in the short term (1 year after the construction).

Lindeboom *et al.* (2011) found the *small sandeel* (*Ammodytes tobianus*) and the *lesser sandeel* (*Ammodytes marinus*) to be the dominating fish species one year after the construction phase, whereas in the present study the *greater sandeel* (*Hyperoplus lanceolatus*) were encountered most frequently. The overall pattern was mainly driven by greater sandeel, in particular juvenile greater sandeel. Lesser sandeel and small sandeel are weakly represented in samples from both areas after 2002.

The increase in sandeel abundance in the impact area the year after constructing the wind farm (the short term effect) was mainly due to an increase in juvenile sandeels. It is possible that this pattern was a consequence of the parallel slight increase in the frequency of sediment particles between 0.1 and 0.2 mm. Numerous studies have shown that *lesser sandeel* (*Ammodytes marinus*) has a particular preference in regard to grain size composition (Wright and Bailey, 2000; Jensen 2001; Holland *et al.* 2005). However, in September 2009 and March 2010 encounters of sandeels in the impact area resembled that of the control area again, while the increase in frequency of sediment particles between 0.1 and 0.2 mm was still detectable in March 2010, but not in September 2009. The difference in sediment composition between September 2009 and March 2010 may be ascribed to the seasonal dynamics of currents and frequencies of strong winds. Alternative explanations for the increased abundance of sandeels in the impact area in 2004 may include shifts in predator abundance, which may have been temporary reduced during the construction phase. For example noise from pile driving sounds are known to trigger behavioural and avoidance responses in fish including predators such as sole and cod (Mueller-Blenkle, *et al.*, 2010).

It has been revealed that it takes c. 3 to 5 years for stable fish communities to establish after intense disturbance of the existing habitats or the introduction of a new habitat (Petersen and Malm, 2006; Gray, 2006). However, if impacts on sandeels are indirect, for example caused by aggregations of predators

due to an artificial reef-effect (Randall, 1963; Davis, *et al.*, 1982), more time may be needed to register responses in cases where predator aggregations are not discernable, as was the case for Horns Rev.

Inter-annual variation in species and age composition and the inter-annual and day and night effects on catchability were striking. Sandeel age-composition (juvenile vs. adults) and between year variation in species-composition indicated a decoupling between species in their population dynamics, presumably attributable to differences in spawning time and larval dispersal patterns. *Lesser sandeel* spawns exclusively during winter, whereas *greater sandeel* spawns in late summer, and *small sandeel* in both the spring and fall seasons (Macer 1966; Reay 1970; Svetovidov, 1986). Consequently, factors determining recruitment success of one species may be different from those affecting the other. For example the winter spawning *lesser sandeel* presumably have longer larval phases (O'Connor, *et al.*, 2007), which in combination with a strong northerly coastal current potentially could transport larvae produced on Horns Rev to areas much further north. Furthermore, the overall lack of young *lesser sandeel* after 2002 indicates that this species is not produced locally. Based on commercial landings, previous studies have indicated an overwintering period of *lesser sandeel* that lasts from August to April (e.g. Winslade 1974; Wright and Baily, 2000; Høines and Bergstad, 2001).

Different feeding behaviour between the species might contribute to inter specific competition affecting the populations of individual species and the trophic level. Data from stomach analysis from the sandeel population at Horns Rev showed that *small sandeel* and *lesser sandeel* have a significantly higher condition than *greater sandeel* (Warnar, 2011). All species displayed the distinct diurnal activity pattern described, characterized by night time burial and daytime foraging. Both *lesser sandeel* and *small sandeel* are planktivorous, feeding on small crustacean plankton, whereas *greater sandeel* only as juvenile is feeding on plankton. Adult *greater sandeels* at lengths between 10-15 cm are predators feeding on other fish e.g. sandeel species (Whitehead, *et al.*, 1986).

Overall catch rates in the present study were comparable to previous findings from Dogger Bank (van der Kooij *et al.* 2008). However, in the present study, daytime catch rates of sandeels differed markedly between September 2009 and March 2010, as well as between early and late March 2010, and the day/night effect detected in September 2009 revealed that roughly 2/3 of the fish, independent of species, left the sand during the day. These findings suggest that the transition between the overwintering period and the feeding period may be more gradual than indicated by the commercial landings data used in the before-mentioned studies, with some activity taking place in March and September. Studies have indicated that the timing of the overwintering period of sandeels is affected by fluctuations in suitable zooplankton prey and temperature (Winslade 1974; van der Kooij *et al.* 2008; van Deurs *et al.* 2010) and therefore strongly affected by inter-annual variation in winter duration.

The modified scallop dredge is designed to disrupt the sandy habitat causing sandeels to flee the sand resulting in some sandeels being caught in the net sack behind the dredge. If overwintering sandeels are buried deeper in the sediment and/or are less alert, and therefore reluctant to flee the sand, this will have negative impact on catchability. According to temperature data from the ICES database (Table 13), the beginning of 2010 was unusually cold. Given that overwintering sandeels are harder to catch, the unusually low temperatures (or the resulting delayed food production in spring) may explain why the number of caught sandeels in March 2010 was low and why sandeel occurrence increased between early and late March.

As sediment quality was largely unaffected throughout the study period, except for the before-mentioned slight increase in grain sizes between 1-2 mm and removal of grain size > 4 mm, this could very well be the main reason why we did not see a negative effect on overall sandeel prevalence. Numerous studies have shown that *lesser sandeel* have a particular preference in regard to grain size composition (Wright and Baily, 2000; Jensen, 2001; Holland, *et al.*, 2005). Holland *et al.* (2005) concluded that a weight fraction of 6% silt+clay in the sediment is the upper limit tolerated by sandeels. Wright and Baily (2000) found that *lesser sandeel* densities were relatively lower in areas where the

clay+silt fraction ranged from 2% to 10%. Additional studies have also shown that there are minimal differences in sediment preference between different species of sandeel (Person, *et al.*, 1984; Pinto, *et al.*, 1984).

In summary, the aforementioned studies appear to indicate that the weight fraction of silt+clay in the sediment provides a strong indicator of the likeliness of an area being populated by sandeels. In relation to present study, the weight fraction of silt+clay in the sediment was not found to be above 1.8% , and even though the highest measured value was found in the impact site one year after the construction phase, it was still well below the critical limit of 2%. Hence it can be concluded that the presence of the wind farm did not result in habitat degradation affecting the sandeel population.

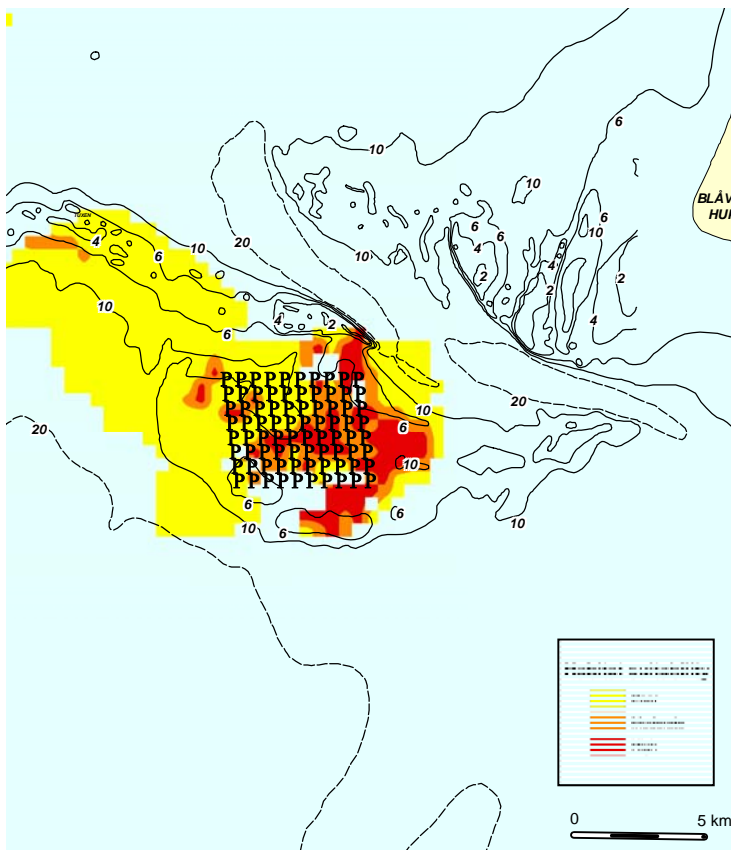

Figure 41. Habitat suitability modelled for sandeel in the Horns Rev I area (After (Jensen, *et al.*, 2006)).

the population of *greater sandeel* in Horns Reef area more or less is independent of recruitment from other spawning areas and act as an important source for the recruitment of *greater sandeel* into other areas of the North Sea. According to the model, larvae of the *lesser sandeel* (*Ammodytes marinus*) are transported north along the coast of Jutland to Skagerak and the coast of Norway and in contrary to the *greater sandeel* the *lesser sandeel* is not able to sustain a population in the Horns Reef area without recruitment from other spawning areas.

Several authors have argued that offshore wind farms have potential positive impact on the local ecosystem rather than introducing a threat due to artificial reef effects and the closure of commercial fishing as in marine protected areas (MPAs) (e.g. Côté *et al.* 2001; Petersen and Malm 2006; Reubens *et al.* 2010). A potential positive MPA effect seems most likely in relation to the sand-dwelling sandeel, and the establishment of MPAs has also previously been suggested as a management tool in relation to sandeels in the North Sea (Christensen *et al.* 2009). According to Vessel Monitoring System (VMS) data generated from the area, commercial fishing for sandeels in 2009 (Figure 42) occurred in areas with high predicted suitability for sandeels in close proximity to the boundaries of Horns Rev I, including the

In the habitat modelling the densities of sandeels could not be fitted to the environmental variables in a reliable manner and it was not possible to develop any useful models based on the available data sets. The main reason for not being able to create any reasonable models is that the sample size is very small, and only covers a small fraction of the important environmental gradients for the sandeels. Hence no clear patterns in the distribution of densities were identified for upgrade of the model elaborated in relation to the Environmental Impact Assessment for the Horns Rev 2 Offshore Wind Farm showing high suitability for sandeels in larger parts of the Horns Rev 1 area (Figure 41). However, results from the surveys and drift simulations shows that the Horns Reef area is of high importance as a spawning and nursery ground for *greater sandeel* (*Hyperoplus lanceolatus*) and that larvae metamorphosis takes place in the area. This means that the



control area. A notable increase in sandeel fishing density occurred between 2003 and 2009, primarily around Horns Rev I, although the fishing intensity in 2003 might be underestimated because VVM data was not reliable until 2005. However, despite this, no positive effect on sandeel abundance in the impact area was detected (see (Bastardie, *et al.*, 2010) for details on the use of VMS data). An explanation of this may be that the reference area is situated outside or along the border of the more intensively fished area, why the effect of fishery is not measurable. Another explanation may be that the home range size of sandeels in the area studied is considerably larger than the size of wind farm (Kramer and Chapman, 1999; Engelhard, *et al.*, 2008). The home range size of *lesser sandeel* on the more isolated banks in deeper water further off-shore is likely to be considerably smaller than in the relatively shallow coastal area with high habitat connectivity (Jensen *et al.* 2011). We therefore cannot exclude the possibility that, given the wind farm is large enough and located in a suitable location, it may serve as a marine reserve.

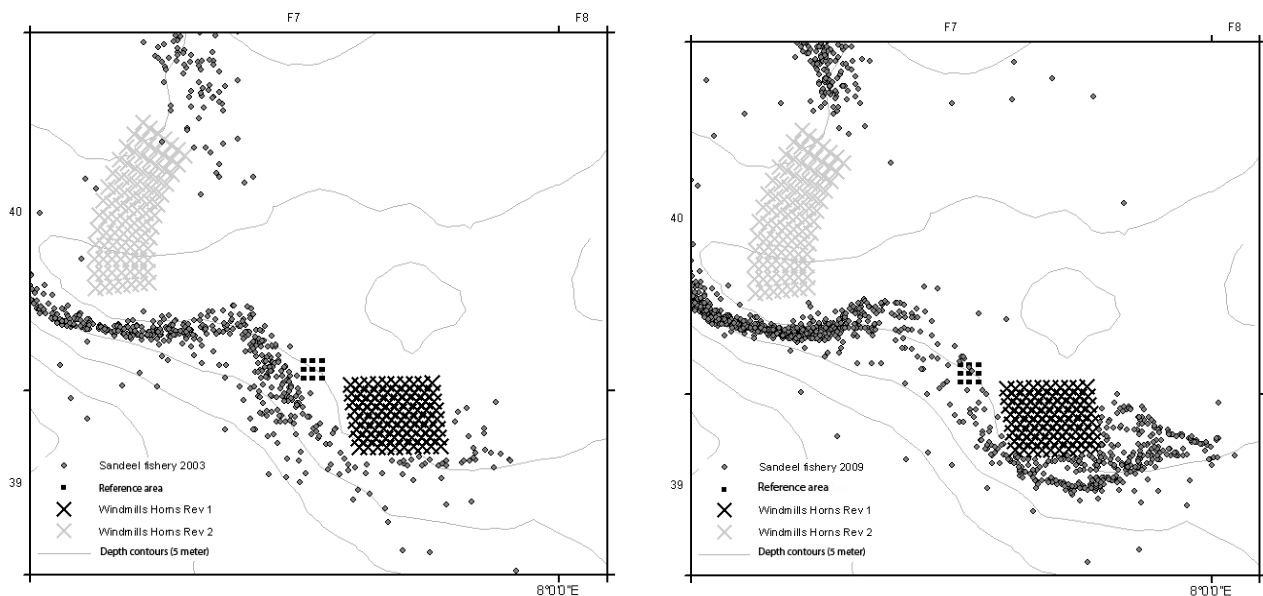

Figure 42. Sandeel fishing activity in 2003 (a) and 2009 (b). Dots represent satellite recordings of sandeel fishing vessels travelling 2-4 knots.

Furthermore, it cannot be ruled out that closures of areas that would otherwise have been fished might provide sites for undisturbed spawning, which in turn may provide benefits (i.e. reserve effects) for sandeel populations beyond the local scale through long distance drifting of the larvae (especially for *greater sandeel*, which spawns during summer when fishing takes place).

EU's Marine Strategy Framework Directive (MSFD) aims to achieve "good environmental status" (GES) for European seas by 2020. The MSFD focuses on 11 qualitative descriptors, of which at least four have direct or indirect relevance to sandeels or their habitats and are sensitive to inappropriate locations of wind farms. Furthermore, EU's Maritime Policy calls for an ecosystem approach to integrated planning of maritime activities which aims for sustainable growth of maritime activities while ensuring that these activities develop in a way that does not threaten marine ecosystem health. Given the increasing rate and scale of wind farm development in the North Sea the methods and results of this study may serve as a contribution to informed decision-making regarding the short- and long-term impacts related to offshore wind farm development in the North Sea.



Cod and herring.

### 4.3 CUMULATIVE EFFECTS

No protected or vulnerable species was registered from the Horns Rev and with the present information obtained from the studies such species are not likely to occur in the area. Furthermore, no negative effects were observed for any of the species encountered and therefore there is no expectation of any negative effects from the Horns Rev I Offshore Wind Farm or other existing (Horns Rev II) or planned offshore wind farms in the Horns Reef area.

However, there is an expectation of a cumulative effect in numbers and recruitment of potential reef habitat fish (ROC) in areas of more wind farms. These fish showed higher abundances in the existing wind farm area and even with presence of new species not recorded previously at the Horns Rev. The development of an increased number of wind farms would similarly provide habitat for more ROC and the new farms may furthermore function as a recipient for drifting smaller life-stages from the existing wind farms and thus the cumulative effect may be an increase in recruitment of these species in the area.

Experiences from post construction studies concerning effects on fish communities from offshore wind farm development are, however, rare or almost missing, why no attempt was made to involve an appropriate Population Viability Assessment (PVA) to appraise effects of increased suitable habitat for certain ROC species. PVA's are recommended to be used for offshore wind farm development in the assessment of cumulative effects on vulnerable populations (Williams, 2005).

For flatfish no effect on abundances have been shown with deployment of offshore wind farm (present study; Lindeboom et al., 2011, Hille Ris Lambers and ter Hofstede, 2009) Hille Ris Lambers and ter Hofstede, 2009). The observed concentrations of flatfish have not been in sufficiently high abundances to encounter density dependent mechanisms (present study; Lindeboom et al., 2011). The cumulative effects deployment of more offshore wind farms is therefore not expected to influence flatfish abundance or distribution.

Gadoid (*cod, whiting*) species were shown to have a high affinity for the vertical structure especially in deeper waters (Hille Ris Lambers and ter Hofstede, 2009; Løkkeborg et al., 2002). The deployment of new farms in deeper waters may thus provide a habitat for larger gadoids, in contrast to the present Horns Rev Offshore Wind Farm, where an increase in fish abundance was indicated with increasing depth. The cumulative effect of introducing vertical structures in deeper waters may be an aggregation of larger gadoids in this area.

Whether or not these offshore wind farms would function as MPA (Marine Protected Area) is uncertain, as the size of these MPAs may not be sufficient for highly migratory species with such a broad distribution. The same may be true for sandeels which have a wide larval dispersion range, in particular the *lesser sandeel* (Christensen, et al., 2009). In that study, the size of an MPA should be of a magnitude of a North Sea ICES rectangle (c. 56 x 65 km) to have a positive impact for this species. However, for

the *greater sandeel* that spawns in coastal areas, has a localised larval drift pattern and whose spawning period coincides with fishery, this species may profit more from the presence of the planned offshore wind farms and the effects of exclusion of fisheries.



*Horns Rev I Vestas turbine*

## 5 Conclusions

The Before-After-Control-Impact (BACI) design was for the first time used for a long term effect study of offshore wind farms on fish communities. Based on the design it was possible to compare fish assemblages Before and After construction and inside (Impact) and outside (Control) the wind farm area of the Horns Rev Offshore Wind Farm.

The introduction of hard substrate in the form of boulders and turbine foundations to the sand bank habitat characteristic of the southern North Sea resulted in minor discernible changes in the fish community and species diversity and only affected the local soft-bottom assemblage of sandeel species temporarily. A temporary and slightly shift in sediment texture shortly after the deployment of the wind farm increasing grain size, although at both the control and impact site, showed to be beneficial for the sandeel population inside the wind farm area. Seven years after no changes could be detected in the sandeel population.

The spatial and temporal variability in the fish communities was very high reflecting significant effect of changes in environmental variables such as temperature and current regimes.

The fish communities in the Horns Reef area showed significant seasonal variation low in species richness and abundance in spring compared to autumn. Especially the unusually cold winter 2009-2010 significantly affected the fish communities both in the wind farm area and in the control area. In general fish abundances and species richness seem to increase with increasing depth, increasing the significance of deployed turbine structures at greater depths as refuge areas for fish.

The aggregation and introduction of particularly reef habitat fish increased biodiversity close to each wind turbine possibly attracted to the wind farm by the increased opportunity for feeding on epifauna.

The near absence of gobies, an important fish prey is suggested as one explanation to why no significant increase in fish abundance of demersal and pelagic fish relative to the control area was found.

The increased feeding opportunity provided by the benthic epifauna developed on the introduced hard substrate is considered to have redistributed fish assemblages from a more evenly to a more patchy distribution in the area.

Cumulative effects of more wind farms in the area may be an increase in recruitment of reef habitat fishes. The cumulative effect of introducing vertical structures in deeper waters may be an aggregation of larger gadoids in this area.

The present study indicates that wind farms represent neither a threat nor a direct benefit to sandeels in near-shore areas dominated by *greater sandeel*. An exclusion of fisheries inside the wind farm area and a cumulative effect of more wind farms resembling marine protected areas (MPA's) might be beneficial to the recruitment of *greater sandeel* due to rehabilitation of trawled seabeds. However, no effect of fisheries was detected in this study due to the location of the control site which was not intensively trawled either before or after the establishment of the Horns Rev I Offshore Wind Farm.

## 6 References

- Almany, G.R. 2004. Differential effects of habitat complexity, predators and competitors on abundance of juvenile and adult coral reef fishes. *Oecologia*. 2004, Vol. 141, 1, pp. 105-113.
- Ambrose, R.F. and Anderson, T.W. 1990. Influence of artificial reef on the surrounding infaunal community. *Mar. Biol.* 1990, 107, pp. 41-52.
- Anderson, M. and Miller, R. 2004. Spatial variation and effects of habitat on temperate reef fish assemblages in northeastern New Zealand. *Journal of Experimental Marine Biology and Ecology*. 2004, Vol. 305, 2, pp. 191-221.
- Anderson, M.H. and Öhman, M.C. 2010. Fish and sessile assemblages associated with wind-turbine constructions in the Baltic Sea. *Mar. Freshw. Res.* 2010, 61, pp. 642-650.
- Arena, P.T.; Jordan, L.K.B and Spieler, R.E. 2007. Fish assemblages on sunken vessels and natural reefs in southeast Florida, USA. *Hydrobiologia*. 2007, 580, pp. 157-171.
- Bastardie, F.; Nielsen, R.J.; Ulrich, C.; Egekvist, J.; Degel, H. 2010. Detailed mapping of fishing effort and landings by coupling fishing logbooks with satellite-recorded vessel geo-location. *Fisheries Effort*. 2010, Vol. 106, pp. 41-53.
- Bergstad, O. A.; Hoines, A.S. and Kruger-Johnsen, E.M. 2001. Spawning time, age and size at maturity, and fecundity of sandeel, *Ammodytes marinus*, in the north-eastern North Sea and in unfished coastal waters off Norway. *Aquatic Living Resources*. 2001, 14, pp. 293-301.
- Bertrand, A.; Gutiérrez, M.; Gerlotto, P.; Espinoza, P.; Bertrand, S.; Ledesma, J.; Quesquén, R.; Alza, L. 2005. How does fish habitat suitability shape the 3D spatial organisation of anchovy across scales? *ICES CM/U:10*. 2005.
- Bohnsack, J.A. 1989. Are High-Densities of Fishes at Artificial Reefs the Result of Habitat Limitation or Behavioural Preference. *Bull. Mar. Sci.* 1989, 44, pp. 631-645.
- Boulcott, P. and Wright, P.J. 2008. Critical timing for reproductive allocation in a capital breeder: Evidence from sandeels. *Aquatic Biology*. 2008, 3, pp. 31-40.
- Brickhill, M.J.; Lee, S.Y. and Connolly, R.M. 2005. Fishes associated with artificial reefs: Attributing changes to attraction or production using novel approaches. *J.Fish.Biol.* 2005, 67, pp. 53-71.
- Brostrom, G. 2008. On the influence of large wind farms on the upper ocean circulation. *Journal of Marine Systems*. 2008, Vol. 74, 1-2, pp. 585-591.
- Buckley, R., & Hueckel, G. 1985. Biological processes and ecological development on an artificial reef in Puget Sound, Washington. *Bull. Mar. Sci.* , Vol. 37, pp. 50-69.
- Cappo, M.; Deáth, G. and Speare, P. 2007. Inter-reef vertebrate communities of the Great Barrier Reef Marine Park determined by baited remote underwater video stations. *Mar. Ecol. Prog. Ser.* 2007, 350, pp. 209-221.
- Chabanet, P.; Ralambondrainy, H.; Amanieu, M.; Faure, G.; Galzin, R. 1997. Relationships between coral reef substrata and fish. *Coral Reefs*. 1997, 16, s. 93-102.
- Christensen, A.; Daewel, U.; Jensen, H.; Mosegaard, H.; St John, M.; Schrum, C. 2007. Hydrodynamic backtracking of fish larvae by individual-based modelling. *Mar. Ecol. Prog. Ser.* 2007, 347, pp. 221-232.
- Christensen, A.; Jensen, H.; Mosegaard, H.; St John, M.; Schrum, C. 2008. Sandeel (*Ammodytes marinus*) larval transport patterns in the North Sea from an individual-based hydrodynamic egg and larval model. *Can. J. Fish. Aquat. Sci.* 2008, 65, pp. 1498-1511.

- Christensen, A.; Mosegaard, H. and Jensen, H. 2009. Spatially resolved fish population analysis for designing MPAs: influence on inside and neighbouring habitats. *ICES Journal of Marine Science: Journal du Conseil*. 2009, Vol. 66, 1, pp. 56-63.
- Clarke, K. and Warwick, R. 1994. Similarity-based testing for community pattern: Teh 2-way layout with no replication. *Mar. Biol.* 1994, 118, pp. 167-176.
- Clarke, K.R. and Warwick, R.M. 2001. *Changes in marine communities: an approach to statistical analysis and interpretation. (2nd edition)*. Plymouth : PRIMER-E, 2001.
- Coleman, M. A. and Connell, S.D. 2001. Week effects of Epibiota on the abundances of fishes associated with pier pilings in Sydney Harbour. *Environmental biology of fishes*. 2001, Vol. 61, 3, pp. 231-239.
- Conway, D.V.P.; Coombs, S.H., and Smith, C. 1997. Vertical distribution of fish eggs and larvae in the Irish Sea and southern North Sea. *ICES J. Mar. Sci.* 1997, 54, pp. 136–147.
- Cote, I.M.; Mosqueira, I. and Reynolds, J.D. 2001. Effects of marine reserve characteristics on the protection of fish populations: a meta-analysis. *Journal of Fish biology*. 2001, 59, pp. 178-189.
- Couperus, B.; Winter, E.; van Keeken, O.; van Kooten, T.; Tribuhl, S.; Burggraaf, D. 2010. *Use of high resolution sonar for near-turbine fish observations (DIDSON) -We@Sea 2007-002*. s.l. : IMARES Wageningen UR, 2010. pp. 1-29. C138/10 .
- Dahl, K., C. Stenberg, S. Lundsteen, J. Støttrup, P. Dolmer, and O.S. Tendal. 2009. *Ecology of Læsø Trindel - A reef impacted by extraction of boulders*. NERI Technical Report No. 757., National Environmental Research Institute, Aarhus University, 1-48 .
- Davis, N.; Vanblaricom, G.R. and Dayton, P.K. 1982. Man-Made Structures on Marine-Sediments - Effects on Adjacent Benthic Communities. *Marine Biology*. 1982, 70, pp. 295-303.
- Dick, S.; Mueller-Navarra, S.H.; Klein, H.; Komo, H.; Kleine, E. 2001. *The operational circulation model of BSH (BSHcmod) - model description and validation* . Hannover : Bundesamt für Seeschifffahrt und Hydrographie, Hamburg (Germany); Bundesamt fuer Seeschifffahrt und Hydrographie, Rostock (Germany), 2001.
- DONG; Vattenfall; The Danish Energy Authority; The Danish Forest and Nature Agency 2006. *Danish Offshore Wind*. s.l. : DONG Energy, vattenfall, The Danish Energy Authority & The Danish forest and Nature Agency, 2006.
- Eigaard, O.R.; Støttrup, J.G. and Hovgård, H. 2000. *Udvikling af standard garnserie til brug i bestandsanalyse af flad- og rundfisk i marine lavandede områder*. s.l. : DFU-Rapport nr. 78-00. Danmarks Fiskeriundersøgelser, 2000. DFU-Rapport nr. 78-00.
- Elsamprojekt. 2000. *Havmøller Horns Rev. Vurderinger af Virkninger på Miljøet*. s.l. : Elsamprojekt, 2000. s. 1-187.
- Energistyrelsen. 2011. *Stor-skala havmølleparker i Danmark. Opdatering af fremtidens havmølleplaceringer. April 2011*. Copenhagen : Energistyrelsen, 2011.
- Engelhard, G.H.; van der Kooij, J.; Bell, E.D.; Pinnegar, J.K.; Blanchard, J.L.; Mackinson, S.; Righton, D.A. 2008. Fishing Mortality versus natural predation on diurnally migrating sandeels *Ammodytes marinus*. *Mar. Ecol. Progr. Ser.* 2008, 369, pp. 213-277.
- Fernandez, T.D.; Wright, P.J.; Heubeck, M.; Harris, M.P.; Mavor, R.A.; Wanless, S. 2005. Regional patterns of kittiwake *Rissa tridactyla* breeding success are related to variability in sandeel recruitment. *Mar. Ecol. Ser.* 2005, 300, pp. 201-211.

- Fernandez, T.V.; D'Anna, G.; Badalamenti, F.; Perez-Ruzafa, A. 2008. Habitat connectivity as a factor affecting fish assemblages in temperate reefs. *Aquatic Biology*. 2008, Vol. 1, 3, pp. 239-248.
- Fosså, J. H. 1991. The Ecology of the 2-Spot Goby (*Gobiusculus-Flavescens* Fabricius) - the Potential for Cod Enhancement. *Ecology and Management Aspects of Extensive Mariculture*. 1991, 192, pp. 147-155.
- Franklin, J. 2009. *Mapping species distributions: spatial inference and prediction*. Cambridge : Cambridge University Press, 2009.
- Frederiksen, M.; Wright, P.J.; Heubeck, M.; Harris, M.P.; Mavor, R.A.; Wanless, S. 2005. Regional patterns of kittiwake *Rissa tridactyla* breeding success are related to variability in sandeel recruitment. *Mar. Ecol. Prog. Ser.* 2005, 300, pp. 201-211.
- Fréon, P., Gerlotto, f. and Soria, M. 1996. Diel variability of school structure with special reference to transitions periods. *ICES J. Mar. Sci.* 1996, pp. 459-464.
- Furness, R.W. 1990. A preliminary assessment of the quantities of Shetland sandeel taken by seabirds, seas , predatory fish and the industrial fishery in 1981. *IBIS*. 1990, 132, pp. 205-217.
- Furness, R.W. 2002. Management implications of interactions between fisheries and sandeel dependent seabirds and seals in the North Sea. *ICES J. Mar. Sci.* 2002, 59, pp. 261-269.
- Gill, A.B.; Gloyne-Phillips, I.; Neal, K.J.; Kimber, J.A. 2005. *Electromagnetic fields. Review. The potential effects of electromagnetic fields generated by sub-sea power cables associated with offshore wind farm developments on electrically and magnetically sensitive marine organisms - a review*. Cranfield University; Centre for Marine and Coastal Studies Ltd. s.l. : COWRIE, 2005. pp. 1-89.
- Gray, J.S. 2006. Minimizing environmental impacts of a major construction: the Øresund Link. *Integrated Environmental Assessment and Management*. 2006, Vol. 2, 2, pp. 196-199.
- Guisan, A. and Zimmermann, N.E. 2000. Predictive habitat distribution models in ecology. *Ecological Modelling*. 2000, 135, pp. 147-186.
- Hain, J.H.W.; Ellis, S.L.; Kenney, R.D.; Clapham, P.J.; Gray, B.K.; Weinrich, M.T.; Babb, I.G. 1995. Apparent bottom feeding by humpback whales on Stellwagen Bank. *Mar. Mamm. Sci.* 1995, 11, pp. 464-479.
- Harris, M.P. and Wanless, S. 1991. The importance of the Lesser Sandeel *Ammodytes marinus* in the diet of the Shag *Phalacrocorax aristotelis*. *Ornis Scand.* 1991, 22, pp. 375-382.
- Hastie, T.J. and Pregibon. 1992. Generalized linear models. [book auth.] J.M. Chambers and T.J. Hastie. *Statistical models in S*. Boca Raton, FL. : Chapman and Hall/CRS Press, 1992.
- Hille Ris Lambers, R. and ter Hofstede, R. 2009. *Refugium Effects of the MEP NSW Windpark on Fish: Progress Report 2007*. s.l. : In Interim report demersal fish: IMARES Institute for Marine Resources & Ecosystem Studies, 2009.
- Hoffmann, E.; Astrup, J.; Larsen, F.; Munch-Petersen, S. 2000. *Effects of marine windfarm on the distribution of fish, shellfish and marine mammals in the Horns rev area*. s.l. : Danish Institute for Fisheries Research, Department of Marine Fisheries. Elsamprojec A/S, 2000. pp. 1-42.
- Høines, Å. S. and Bergstad, O. A. 2001. Density of wintering sand eel in the sand recorded by grab catches. *Fish. Res.* 2001, 49, pp. 295-301.
- Holland, G.J.; Greenstreet, S.P.R.; Gibb, I.M.; Fraser, H.M.; Robertson, M.R. 2005. Identifying sandeel *Ammodytes marinus* sediment habitat preferences in the marine environment. *Mar. Ecol. Prog. Ser.* 2005, 303, pp. 269-282.

- Hvidt, C.B.; Leonhard, S.B.; Klaustrup, M.; Pedersen, J. 2006. *Hydro-acoustic monitoring of fish communities at offshore wind farms. Horns Rev Offshore Wind Farm Annual report*. s.l. : Bio/consult as. Vattenfall, 2006. pp. 1-54.
- ICES. 2008. Manual for the Baltic International Acoustic Survey (BIAS). Addendum 2: WGBIFS BIAS Manual 2008. Version 0.80. 2008. pp. 1-27, Baltic International Fish Survey Working Group (WGBIFS).
- ICES. 2010. Report of the Working Group on the Assessment of Demersal Stocks in the North Sea and Skagerrak (WGNSSK). 2010, ICES CM 2010/ACOM:13.
- Jansson, B.O., Aneer, G. and Nellbring, S. 1985. Spatial and temporal distribution of the demersal fish fauna in a Baltic archipelago as estimated by SCUBA census. *Marine Ecology Progress Series*. 1985, Vol. 23, 1, pp. 31-43.
- Jensen, A. 2002. Artificial reefs in Europe: Perspective and future. *ICES J. Mar. Sci.* 2002, 59 (Suppl.), pp. 3-13.
- Jensen, B.; Klaustrup, M. and Skov, H. 2006. *EIA report. Fish Horns Rev 2 Offshore Wind Farm*. s.l. : Bio/consult as. Energy E2 (Dong), 2006. pp. 1-68.
- Jensen, H. 2001. *Settlement dynamics in the lesser sandeel *Ammodytes marinus* in the North Sea*. s.l. : University of Aberdeen, 2001. Thesis.
- Jensen, H.; Rindorf, A.; Wright, P.J.; Mosegaard, H. 2011. Inferring the location and scale of mixing between habitat areas of lesser sandeel through information from fishery. *ICES J. Mar. Sci.* 2011, Vol. 68, 1, pp. 43-51.
- Jensen, H.; Kristensen, P.S. and Hoffmann, E. 2003. *Sandeels and clams (*Spisula sp.*) in the wind turbine area at Horns Rev*. s.l. : Techwise, 2003.
- Jensen, H.; Kristensen, P.S.; Hoffmann, E. 2004. *Sandeels in the wind turbine park at Horns Rev*. s.l. : Danish Institute for Fisheries Research. Elsam, 2004. pp. 1-26.
- Jensen, H.; Wright, P. and Munk, P. 2003. Vertical distribution of pre-settled sandeel (*Ammodytes marinus*) in the North Sea in relation to size and environmental variables. *ICES J. Mar. Sci.* 2003, 60, pp. 1342-1351.
- Karlsen, J. 2011. Hot on the tail of hefty Atlantic cod: an interdisciplinary study on the behaviour at ship wrecks in the North Sea. Ph.D. , Aarhus University.
- Kramer, D.L. and Chapman, M.R. 1999. Implications of fish home range size and relocation for marine reserve function. *Environmental Biology of Fishes*. 1999, 55, pp. 65-79.
- Krog, C. 1993. *Fiskeri og Havmiljø (in Danish)*. København : GAD, 1993. ISBN: 87-12-02042-7.
- Kunzlik, P.A.; Gauld, J. A. and Hutcheon, J. R. 1986. Preliminary results of the Scottis sandeel tagging project. *ICES CM 1986/G:7*. 1986, pp. 1-6.
- Kvist, T.; Gislason, H. and Thyregod, P. 2001. Sources of variation in the age composition of sandeel landings. *ICES J. Mar. Sci.* 2001, 58, pp. 842-851.
- Langhammer, O. and Wilhelmsson, D. 2009. Colonisation of fish and crabs of wave energy foundations and the effects of manufactured holes - A field experiment. *Mar. Environ. res.* 2009, 68, pp. 151-157.
- Leitao, F.; Santos, M.N.; Erzini, K.; Monteiro, C.C. 2008. Fish assemblages and rapid colonization after enlargement of an artificial reef off the Algarve coast (Southern Portugal). *Mar. Ecol.* 2008, Suppl. 4, pp. 435-448.



- Leonhard, S.B. and Pedersen, J. 2006. *Benthic communities at Horns Rev. Before, during and after construction of Horns Rev Offshore Wind Farm. Final report 2005*. s.l. : Vattenfall, 2006. pp. 1-187.
- Leonhard, S.B.; Hvidt, C.B.; Klausrup, M.; Pedersen, J. 2006. *Hydroacoustic monitoring of fish communities at offshore wind turbine foundations. Nysted Offshore Wind farm at Rødsand*. s.l. : DONG Energy, 2006. pp. 1-65.
- Lindeboom, H.J.; Kouwenhoven, H.J.; Bergman, M.J.N.; Bouma, S.; Brasseur, S.; Daan, R.; Fijn, R.C.; de Haan, D.; Dirksen, S.; van Hal, R.; Lambers, R.H.R.; ter Hofstede, R.; Krijgsveld, K.L.; Leopold, M.; Scheidat, M. 2011. Short-term ecological effects of an offshore wind farm in the Dutch coastal zone; a compilation. *Environ. Res. Lett.* 2011, 6, s. 1-13.
- Løkkeborg, S.; Humborstad, O.B.; Jørgensen, T.; Soldal, A.V. 2002. Spatio-temporal variations in gillnet catch rates in the vicinity of North Sea oil platforms. *ICES J. Mar. Sci.* 2002, 59, pp. 294-299.
- Maar, M.; Bolding, K.; Petersen, J.K.; Hansen, J.L.S.; Timmermann, K. 2009. Local effects of blue mussels around turbine foundations in an ecosystem model of Nysted off-shore wind farm, Denmark. *J. Sea Res.* 2009, Årg. 62, 2-3, s. 159-174.
- Macer, C. T. 1965. The distribution of larval sand eels (Ammodytidae) in the southern North Sea. *J. Mar. Biol. Ass. UK.* 1965, 45, pp. 187-207.
- Macer, C. T. 1966. Sandeels (Ammodytidae) in the south-western North Sea, their biology and fishery. *Fish. Invest. Lond. Ser. 2.* 1966, 24, pp. 1-55.
- Mackinson, S.; Turner, K.; Righton, D.; Metcalfe, J.D. 2005. Using acoustics to investigate changes in efficiency of a sandeel dredge. *Fisheries Research.* 2005, 71, s. 357–363.
- Magnhagen, C. 1998. Alternative reproductive tactics and courtship in the common goby. . *Journal of Fish Biology.* 1998, Vol. 53, 1, pp. 130-137.
- Mann, K.H. and Lazier, J.R.N. 1991. Fronts in Coastal Waters in Dynamics of Marine Ecosystems. . [book auth.] K.H. Mann and J.R.N Lazier. *Biological-Physical Interactions in the Oceans*. Boston : Blackwell, 1991, pp. 213-254.
- Martin, C.J.B. and Lowe, G. 2010. Assemblage structure of fish at offshore petroleum platforms on the San OPedro shelf of southern California. *Marine and Coastal Fisheries Dynamics, Management and Ecosystem Science.* 2010, 2, pp. 180-194.
- Mueller-Blenkle, C.; McGregor, P.K.; Gill, A.B.; Andersson, M.H.; Metcalfe, J.; Bendall, V.; Sigray, P.; Wood, D.; Thomsen, F. 2010. *Effects of Pile-driving Noise on the Behaviour of Marine Fish*. s.l. : COWRIE, 2010. Technical Report 31th March 2010. Fish 06-08 / Cefas Ref: C3371.
- Nedwell, J. and Howell, D. 2004. *A review of offshore windfarm related underwater noise sources*. s.l. : COWRIE, 2004. pp. 1-57. Report No. 544 R 0308.
- O'Connor, M.I.; Bruno, J.F.; Gaines, S.D.; Halpern, B.S.; Lester, S.E.; Kinlan, B.P.; Weiss, J.M. 2007. Temperature control of larval dispersal and the implications for marine ecology, evolution, and conservation. *Proceedings of the National Academy of Sciences of the United States of America.* 2007, Vol. 104, pp. 1266-1271.
- Page, H.M.; Dugan, J.E.; Schroeder, D.M.; Nishimoto, M.M; Love, M.S; Hoesterey, J.C. 2007. Trophic links and condition of a temperate reef fish: Comparisons among offshore oil platform and natural reef habitats. *Mar. Ecol. Prog. Ser.* 2007, 344, pp. 245-256.

- Person, G.J.; Woodruff, D.L. and Sugarman, P.C. 1984. The burrowing behavior of sand lance. *Ammodytes hexapterus*: Effects of oil-contaminated sediment. *Marine Environmental Research*. 1984, Vol. 11, 1, pp. 17-32.
- Petersen, J.K. and Malm, T. 2006. Offshore Windmill Farms. Threats to or possibilities for the marine environment. *Journal of the Human Environment*. 2006, Vol. 35, 2, pp. 75-80.
- Pinto, J.M.; Pearson, E.H. and Anderson, J.W. 1984. Sediment preferences and oil contamination in the Pacific sand lance *Ammodytes hexapterus*. *Mar. Biol.* 1984, Vol. 83, 2, pp. 193-204.
- Popp, K. M. 1994. Tobis or not tobis. Et vigtigt spørgsmål for dansk fiskeri. *Fisk og Hav*. 1994, 45, pp. 27-34.
- Proctor, R.; Wricht, P.J. and Everitt, A. 1998. Modelling the transport of larval sandeels on the North-West European shelf. *Fish. Oceanogr.* 1998, 7, pp. 347-354.
- Randall, J. E. 1963. An analysis of fish populations at artificial and natural reefs in the Virgin Islands. *Caribbean Journal of Science*. 1963, 3, pp. 31-47.
- Reay, P. J. 1970. Synopsis of biological data on North Atlantic sandeels of the genus *Ammodytes* (*A. tobianus*, *A. dubius*, *A. americanus* and *A. marinus*). *Fish. Synops.* 1970, 82.
- Reay, P. J. 1986. *Ammodytidae*. [book auth.] P.J.P. Whitehead, et al. *Fishes of the north-eastern Atlantic and the Mediterranean*. s.l. : UNESCO, 1986, Vol. Vol. 2, pp. 945-950.
- Reay, P. J. 1973. Some aspects of the biology of the sandeel *Ammodytes tobianus* L. in Langstone Harbour. Hampshire. *J. Mar. Biol. Assoc. U.K.* 1973, Vol. Vol. 53, 2, pp. 325-342.
- Reay, P. J. 1970. Synopsis of the biological data on North Atlantic sandeels of the genus *Ammodytes*. *Fisheries Synopsis FAO*. 1970, 82.
- Reeves, S.A. 1994. Seasonal and annual variation in catchability of sandeels at Shetland. *ICES C.M.D.* 1994, 19.
- Reubens, J.T.; Dagraer, S. and Vinex, M. 2010. Aggregaion and feeding behaviour of pouting (*Trisopterus luscus*) at wind turbine in the Belgian part of the North Sea. *Fisheries Research*. 2010, Vol. 108, 1, pp. 223-227.
- Rilov, G. and Benayahu, Y. 1998. Vertical artificial structures as an alternative habitat for coral reef fishes in disturbed environments. *Marine Environmental Research*. 1998, 45, pp. 431-451.
- Robards, M.D.; Piatt, J.F. and Rose, G.A. Maturation, fecundity, and intertidal spawning of Pacific sand lance in the northern Gulf of Alaska. *J. Fish. Biol.* 54, pp. 1050-1068.
- Robinson, C.J. and Gómez-Gutiérrez, J. 2005. Tidal front dynamics and Pacific sardine aggregations in Bahia Magdalena, south west coast of Baja California, Mexico. *ICES CM 2005/U:25*. 2005.
- Rogers, S.; Casini, M.; Cury, P.; Heath, M.; Irigoien, X.; Kuosa, H.; Scheidat, M.; Skov, H.; Stergiou, K.; Trenkel, V.; Wikner, J.; Yunev, O. 2010. *Marine strategy framework directive Task group 4 report. Food Webs*. European Commission, ICES. s.l. : (Ed.) Piha, H., 2010. pp. 1-55, JRC Scientific and Technical Reports. EUR 24343 EN - 2010.
- SAS. 1996. *The SAS system for Windows, release 6.12*. Cary NC : SAS Institute Inc., 1996.
- Smith, E.P.; Orvos, D.R. and Cairns, J. 1993. Impact Assessment Using the before-after-Control-Impact (Baci) Model - Concerns and Comments. *Canadian Journal of fisheries and Aquatic Sciences*. 1993, Vol. 50, 3, pp. 627-637.

- Soldal, A.V.; Svellingen, I.; Jørgensen, T.; Løkkeborg, S. 2002. Rigs-to-reefs in the North Sea: Hydroacoustic quantification of fish in the vicinity of a "semi-cold" platform. *ICES J. Mar. Sci.* 2002, 59, pp. 281-287.
- Sparrevojn, C. R. and Støttrup, J. G. 2008. Diet, abundance, and distribution as indices of turbot (*Psetta maxima* L.) release habitat suitability. *Fisheries Science (Reviews)*. 2008, Vol. 16, 1-3, pp. 338-347.
- Stenberg, C.; Christoffersen, M.O.; Krog, C.; Patrizio, M.; Dolmer, P. 2010. Offshore wind farms and their potential for shellfish aquaculture and restocking. *ICES C.M.* 2010, Vols. ICES Council Meeting, 2010, Nantes, France.
- Svetovidov, A.N. 1986. *Fishes of the North-Eastern Atlantic and the Mediterranean vol. 2., Gadidae.* [ed.] P.J.P. Whitehead. 1986.
- The R project for statistical computing.* Anonymous. s.l. : <http://www.r-project.org>.
- van der Kooij, J. 2008. The effects of environmental factors on daytime sandeel distribution and abundance on the Dogger Bank. *J. Sea Res.* 2008, 60, pp. 201-209.
- van Deurs, M.; Christensen, A.; Frisk, C.; Mosegaard, H. 2010. Overwintering strategy of sandeel ecotypes from an energy/predation trade-off perspective. *J. Mar. Ecol. Prog. Ser.* 2010, 416, pp. 201-214.
- Wanless, S.; Harris, M.P.; Redman, P.; Speakman, J.R. 2005. Low energy values of fish as a probable cause of a major seabird breeding failure in the North Sea. *Mar. Ecol. Prog. Ser.* 2005, 294, pp. 1-8.
- Warnar, T. 2011. *A multidisciplinary study of for sandeel species coexisting on Horns reef.* . s.l. : University of Aarhus Copenhagen, DTU Aqua, 2011. Thesis Master.
- Wheeler, A. 1969. *The Fishes of the British Isles and North-West Europe.* London, Melbourne and Toronto : Macmillan, 1969. pp. 1-163.
- Whitehead, P. J.P.; Bauchot, M. L.; Hureau, J. C.; Nielsen, J.; Tortonese (Eds.), E. 1986. *Fishes of the North-eastern Atlantic and the Mediterranean. Vol. 3.* Paris : UNESCO, 1986.
- Whitehead, P.J.; Bauchot, M.L.; Hureau, J.C.; Neilsen, J.; Tortonese, E. 1986. *Fishes of the North-eastern Atlantic and the Mediterranean.* Paris : UNESCO, 1986. Vol. Vol 2. ISBN 92-3-002308-6..
- Wilhelmsson, D.; Malm, T. and Öhman, M.C. 2006. The influence of offshore windpower on demersal fish. *ICES J. Mar.Sci.* 2006, 63, pp. 775-784.
- Wilhelmsson, D.; Yahya, S. and Ohman, M. 2006. Effects of high-relief structure on cold temperate fish assemblages: A field experiment. *Mar. Biol. Res.* 2006, 2, pp. 136-147.
- Williams, K. 2005. *Guidance. Cumulative Effects of Windfarms. Version 2.* s.l. : Scottish Natural Heritage, 2005.
- Winslade, P. 1974a. Behavioural studies on the lesser sandeel *Ammodytes marinus* (Raitt). I. The effect of food availability on activity and the role of olfaction in food detection. *J- Fish. Biol.* 1974a, 6, pp. 565-576.
- Winslade, P. 1974c. Behavioural studies on the lesser sandeel *Ammodytes marinus* (Raitt). I. The effect of temperature on activity and the environmental control of the annual cycle of activity. *J. Fish. Biol.* 1974c, 6, pp. 587-599.
- Winslade, P. 1974b. Behavioural studies on the lesser sandeel *Ammodytes marinus* (Raitt). II. The effect of light intensity on activity. *J. Fish. Biol.* 1974b, 6, pp. 577-586.

- Winter, H.V.; Aarts, G. og van Keeken, O.A. 2010. *Residence time and behaviour of sole and cod in the Offshore Wind farm Egmond aan Zee (OWEZ)*. IJmuiden, NL : NoordzeeWind, IMARES Wageningen UR, 2010.
- Wood, S. N. 2006. *Generalized Additive Models: An Introduction with R*. London : Chapman and Hall, 2006.
- Wood, S.N. and Augustin, N.H. 2002. GAMs with integrated model selection using penalized regression splines and applications to environmental modelling. *Ecological Modelling*. 2002, 157, pp. 157-177.
- Wright, P. J.; Jensen, H. and Tuck, I. 2000. The influence of sediment type on the distribution of the lesser sandeel, *Ammodytes marinus*. *J. Sea Res.* 2000, Vol. 44, 3-4, pp. 243-256.
- Wright, P.J. and Bailey, M.C. 1996. Timing of hatching in *Ammodytes marinus* from Shetland waters and its significance to early growth and survivorship. *Mar. Biol.* 1996, 126, pp. 143-152.

# Appendices

# APPENDIX I

## Appendix I. Species list.

Scientific name	Common name	2001	2002	2003	2003	2004	2004	2005	2005	2009	2010	Obs.	Gill nets	Trawl	Wind farm	Reference
		Autumn	Spring	Spring	Autumn	Spring	Autumn	Spring	Autumn	Autumn	Spring					
<i>Agonus cataphractus</i>	Hooknose	x	x	x	x	x	x	x		x	x	x	x		x	x
<i>Ammodytes marinus</i>	Lesser sandeel								x					x	x	x
<i>Ammodytes tobianus</i>	Small sandeel					x			x				x	x	x	x
<i>Ammodytidae</i>	Sandeels	x	x			x	x	x	x	x		x	x		x	x
<i>Amoglossus laterna</i>	Mediterranean scaldfish								x					x	x	x
<i>Buglossidium luteum</i>	Solenette								x					x	x	
<i>Callionymus lyra</i>	Dragonet	x	x		x		x		x	x		x	x	x	x	x
<i>Callionymus maculatus</i>	Spotted dragonet									x			x			x
<i>Callionymus sp.</i>	Dragonet	x								x			x		x	x
<i>Clupea harengus</i>	Atlantic herring		x							x	x		x		x	x
<i>Ctenolabrus rupestris</i>	Goldsinny wrasse				x		x		x	x		x	x	x	x	
<i>Cyclopterus lumpus</i>	Lumpsucker					x						x	x			
<i>Entelurus aequoreus</i>	Snake pipefish								x					x	x	
<i>Gadus morhua</i>	Atlantic cod	x	x		x		x		x	x	x	x	x	x	x	x
<i>Gasterosteus aculeatus</i>	Three-spined stickleback												x		x	
<i>Gobiidae indet.</i>	Unidentified gobies									x			x			x
<i>Hippoglossoides platessoides</i>	American plaice		x							x			x		x	x
<i>Hyperoplus lanceolatus</i>	Great sandeel								x					x	x	x
<i>Labrus bergylta</i>	Ballan wrasse						x					x			x	
<i>Lepidorhombus whiffiagonis</i>	Megrim									x			x			x
<i>Limanda limanda</i>	Dab	x	x						x	x	x		x	x	x	x
<i>Merlangius merlangus</i>	Whiting	x	x		x				x	x		x	x	x	x	x
<i>Microstomus kitt</i>	Lemon sole		x							x			x		x	x
<i>Mullus surmuletus</i>	Surmullet				x				x			x		x	x	x
<i>Myoxocephalus scorpius</i>	Shorthorn sculpin	x	x		x	x	x	x	x	x	x	x	x	x	x	x
<i>Pholis gunellus</i>	Rock gunnel	x	x	x	x	x	x		x	x	x	x	x		x	x
<i>Platichthys flesus</i>	European flounder	x	x							x			x		x	x
<i>Pleuronectes platessa</i>	European plaice	x	x						x	x	x		x	x	x	x
<i>Pollachius virens</i>	Saithe				x	x	x		x	x		x	x	x	x	x
<i>Pomatoschistus minutus</i>	Sand goby				x		x	x	x			x		x	x	x
<i>Pomatoschistus pictus</i>	Painted goby						x					x			x	
<i>Psetta maxima</i>	Turbot	x								x			x		x	x
<i>Salmo trutta</i>	Sea trout										x		x		x	
<i>Scomber scombrus</i>	Atlantic mackerel						x			x		x	x		x	x
<i>Scophthalmus rhombus</i>	Brill								x	x			x	x	x	x
<i>Solea solea</i>	Common sole	x	x							x			x		x	
<i>Sprattus sprattus</i>	European sprat		x				x			x	x	x	x		x	x
<i>Symphodus melops</i>	Corkwing wrasse				x				x			x		x	x	
<i>Syngnathus rostellatus</i>	Nilsson's pipefish								x					x		x
<i>Syngnathus typhle</i>	Broadnosed pipefish						x					x			x	
<i>Taurulus bubalis</i>	Longspined bullhead					x	x	x				x			x	
<i>Trachurus trachurus</i>	Atlantic horse mackerel	x			x				x	x		x	x	x	x	x
<i>Chelidonichthys lucerna</i>	Tub gurnard								x	x			x	x	x	
<i>Trisopterus luscus</i>	Pouting		x		x		x		x	x		x	x		x	x
<i>Zoarces viviparus</i>	Eelpout			x	x	x				x		x	x		x	
<b>Total no. of species</b>		<b>14</b>	<b>16</b>	<b>3</b>	<b>14</b>	<b>9</b>	<b>16</b>	<b>5</b>	<b>24</b>	<b>28</b>	<b>11</b>	<b>22</b>	<b>32</b>	<b>21</b>	<b>41</b>	<b>30</b>

## APPENDIX II

Appendix II. Catches from trawl. 18-09-2009, 3-4 PM.

Group	Common name	Scientific name	Number		Weight (g)		Mean length (cm)	
			Impact	Control	Impact	Control	Impact	Control
<b>Fish</b>								
	Herring	<i>Clupea harengus</i>	40		16			
	Great sandeel	<i>Hyperoplus lanceolatus</i>		1		12		33
	Dab	<i>Limanda limanda</i>	1	5	145	5	50	9.4
	Whiting	<i>Merlangius merlangius</i>		1		15		25
	Sand goby	<i>Pomatoschistus minutus</i>	1		1		10	
	Pipefish	<i>Syngnathus spp.</i>	1	5	1	6	30	22.2
	<b>Total</b>		<b>43</b>	<b>12</b>	<b>163</b>	<b>38</b>		
<b>Invertebrates</b>								
	Squids	<i>Coleoidea</i>	3	11	1	6		
	Brown shrimp	<i>Crangon crangon</i>	20	50	22	58		
	<b>Total</b>		<b>23</b>	<b>61</b>	<b>23</b>	<b>64</b>		

## APPENDIX III

Appendix III. Species allocated to groups based on their ecological habitat. These groups were pelagic (PEL), demersal (DEM), demersal burrowing (DEB) and reef (ROC).

<b>Species</b>	<b>latin</b>	<b>group</b>
Hook-nose	<i>Agonus cataphractus</i>	DEM
Sand eel	<i>Ammodytes tobianus</i>	DEB
Sand eel	<i>Ammodytidae</i>	DEB
Mediterranean scaldfish	<i>Arnoglossus laterna</i>	DEB
Solenette	<i>Buglossidium luteum</i>	DEB
Dragonnet lyre	<i>Callionymus lyra</i>	DEM
Dragonnet tacheté	<i>Callionymus maculatus</i>	DEM
Dragonnet	<i>Callionymus spp.</i>	DEM
Shrimps	<i>Caridea</i>	DEM
Herring	<i>Clupea harengus</i>	PEL
Goldsinny Wrasse	<i>Ctenolabrus rupestris</i>	ROC
Lumpsucker	<i>Cyclopterus lumpus</i>	ROC
Cod	<i>Gadus morhua</i>	DEM
Three-spined stickleback	<i>Gasterosteus aculeatus</i>	DEM
Gobies	<i>Gobiidae</i>	DEM
American plaice	<i>Hippoglossoides platessoides</i>	DEB
Greater seel	<i>Hyperoplus lanceolatus</i>	DEB
Cardine franche	<i>Lepidorhombus whiffiagonis</i>	DEB
Dab	<i>Limanda limanda</i>	DEB
Whiting	<i>Merlangius merlangius</i>	DEM
Lemon sole	<i>Microstomus kitt</i>	DEB
Sculpin	<i>Myoxocephalus spp.</i>	ROC
Rock gunnel	<i>Pholis gunnellus</i>	ROC
Flounder	<i>Platichthys flesus</i>	DEB
Plaice	<i>Pleuronectes platessa</i>	DEB
Saithe	<i>Pollachius virens</i>	DEM
Goby	<i>Pomatoschistus minutus</i>	DEM
Turbot	<i>Psetta maxima</i>	DEB
Sea trout	<i>Salmo trutta</i>	PEL
Mackerel	<i>Scomber scombrus</i>	PEL
Brill	<i>Scophthalmus rhombus</i>	DEB
Small-spotted catshark	<i>Scyliorhinus canicula</i>	DEM
Dover sole	<i>Solea solea</i>	DEB
Sprat	<i>Sprattus sprattus</i>	PEL
Horse mackerel	<i>Trachurus trachurus</i>	DEM
Pouting	<i>Trisopterus luscus</i>	ROC
Yellow gurnard	<i>Yellow gurnard</i>	DEM
Viviparous eelpout	<i>Zoarces viviparus</i>	ROC



## APPENDIX IV

Appendix IV. Average standardized catch rates (mean) per gillnet with standard deviation (sd)

Autumn 2001 survey

Year:	55						58						95						Impact					
2001	far		midt		near		far		midt		near		far		midt		near		far		midt		near	
Species (DK) [Latin]	mean	sd	mean	sd	mean	sd	mean	sd	mean	sd	mean	sd	mean	sd	mean	sd	mean	sd	mean	sd	mean	sd	mean	sd
American plaice (Håising )][Hippoglossoides platessoides]	-	-	-	-	-	-	-	-	-	-	-	-	-	-	-	-	-	-	-	-	-	-	-	-
Brill (Slethvarre )][Scophthalmus rhombus ]	-	-	-	-	-	-	-	-	-	-	-	-	-	-	-	-	-	-	-	-	-	-	-	-
Cardine franche (Glashvarre )][Lepidorhombus whiffiagonis ]	-	-	-	-	-	-	-	-	-	-	-	-	-	-	-	-	-	-	-	-	-	-	-	-
Cod (Torsk )][Gadus morhua ]	0.13	0.25	-	-	-	-	0.13	0.25	-	-	-	-	-	-	-	-	0.17	0.29	0.33	0.58	-	-	0.67	0.58
Dab (Ising )][Limanda limanda ]	0.88	0.63	1.25	1.32	0.50	0.41	0.50	0.71	0.25	0.29	1.00	0.41	1.33	0.29	0.83	1.04	0.50	-	5.67	3.21	3.67	2.89	4.67	2.08
Dover sole (Tunge )][Solea solea ]	0.75	0.87	-	-	0.13	0.25	0.38	0.25	0.38	0.48	0.38	0.48	0.67	0.76	-	-	0.33	0.29	0.33	0.58	0.33	0.58	0.33	0.58
Dragonnet (Fløjfisk (uspec) )][Callionymus spp. ]	0.13	0.25	-	-	-	-	0.25	0.50	-	-	-	-	-	-	-	-	-	-	-	-	-	-	-	-
Dragonnet lyre (Fløjfisk (str) )][Callionymus lyra ]	-	-	-	-	-	-	-	-	-	-	-	-	0.17	0.29	-	-	-	-	-	-	-	-	0.33	0.58
Dragonnet tachteté (Fløjfisk (pl) )][Callionymus maculatus ]	-	-	-	-	-	-	-	-	-	-	-	-	-	-	-	-	-	-	-	-	-	-	-	-
Flounder (Skrubbe )][Platichthys flesus ]	0.13	0.25	-	-	-	-	-	-	-	-	0.13	0.25	-	-	0.17	0.29	-	-	-	-	-	-	-	-
Gobies (Kutling )][Gobiidae ]	-	-	-	-	-	-	-	-	-	-	-	-	-	-	-	-	-	-	-	-	-	-	-	-
Goldsinny Wrasse (Havkarudse )][Ctenolabrus rupestris ]	-	-	-	-	-	-	-	-	-	-	-	-	-	-	-	-	-	-	-	-	-	-	-	-
Herring (Sild )][Clupea harengus ]	-	-	-	-	-	-	-	-	-	-	-	-	-	-	-	-	-	-	-	-	-	-	-	-
Hook-nose (Ulk-panserulk )][Agonus cataphractus ]	0.50	0.58	0.13	0.25	0.25	0.29	0.13	0.25	-	-	0.38	0.48	1.00	1.32	0.17	0.29	0.67	0.58	1.67	2.08	3.33	2.31	1.67	1.53
Horse mackerel (Hestemakrel )][Trachurus trachurus ]	-	-	-	-	-	-	0.13	0.25	0.13	0.25	-	-	-	-	-	-	-	-	-	-	-	-	-	-
Lemon sole (Rødtunge )][Microstomus kitt ]	-	-	-	-	-	-	-	-	-	-	-	-	-	-	-	-	-	-	-	-	-	-	-	-
Lumpsucker (Stenbider )][Cyclopterus lumpus ]	-	-	-	-	-	-	-	-	-	-	-	-	-	-	-	-	-	-	-	-	-	-	-	-
Mackerel (Makrel )][Scomber scombrus ]	-	-	-	-	-	-	-	-	-	-	-	-	-	-	-	-	-	-	-	-	-	-	-	-
Plaice (Rødspætte )][Pleuronectes platessa ]	0.13	0.25	0.13	0.25	0.50	0.58	0.50	0.41	0.38	0.48	-	-	-	-	-	-	0.67	0.29	2.00	1.00	2.00	1.73	1.67	1.53
Pouting (Skægtorsk )][Trisopterus luscus ]	-	-	-	-	-	-	-	-	-	-	-	-	-	-	-	-	-	-	-	-	-	-	-	-
Rock gunnel (Tangspræl )][Pholis gunnellus ]	-	-	-	-	-	-	-	-	-	-	-	-	0.17	0.29	-	-	-	-	0.33	0.58	-	-	-	-
Saithe (Sej )][Pollachius virens ]	-	-	-	-	-	-	-	-	-	-	-	-	-	-	-	-	-	-	-	-	-	-	-	-
Sand eel (Tobis )][Ammodytidae ]	0.38	0.48	-	-	0.13	0.25	0.88	1.44	1.25	1.55	0.75	0.96	0.17	0.29	0.17	0.29	-	-	-	-	0.67	0.58	1.00	1.00
Sculpin (Ulk )][Myxocephalus spp. ]	-	-	-	-	-	-	0.13	0.25	-	-	-	-	-	-	-	-	-	-	-	-	0.33	0.58	-	-
Sea trout (Ørred )][Salmo trutta ]	-	-	-	-	-	-	-	-	-	-	-	-	-	-	-	-	-	-	-	-	-	-	-	-
Sprat (Brisling )][Sprattus sprattus ]	-	-	-	-	-	-	-	-	-	-	-	-	-	-	-	-	-	-	-	-	-	-	-	-
Three-spined stickleback(Hundestejle 3p )][Gasterosteus aculeatus ]	-	-	-	-	-	-	-	-	-	-	-	-	-	-	-	-	-	-	-	-	-	-	-	-
Turbot (Pighvarre )][Psetta maxima ]	-	-	-	-	0.13	0.25	0.13	0.25	-	-	-	-	-	-	-	-	-	-	0.67	0.58	0.33	0.58	-	-
Viviparous eelpout (Ålekvabbe )][Zoarces viviparus ]	-	-	-	-	-	-	-	-	-	-	-	-	-	-	-	-	-	-	-	-	-	-	-	-
Whiting (Hvilling )][Merlangius merlangius ]	3.00	1.58	3.13	2.66	2.25	0.87	5.38	2.53	3.88	0.75	4.63	1.75	3.67	3.40	3.50	4.36	2.67	1.26	39.33	34.02	15.67	8.33	28.33	11.85
Yellow gurnard (Knurhane (rød) )][Yellow gurnard ]	-	-	-	-	-	-	-	-	-	-	-	-	-	-	-	-	-	-	-	-	-	-	-	-

Spring 2002 survey

Year: 2002	55						58						95						Impact					
	far		midt		near		far		midt		near		far		midt		near		far		midt		near	
Species (DK) [Latin]	mean	sd	mean	sd	mean	sd	mean	sd	mean	sd	mean	sd	mean	sd	mean	sd	mean	sd	mean	sd	mean	sd	mean	sd
American plaice (Håising )][Hippoglossoides platessoides]	-	-	0.25	0.29	-	-	-	-	-	-	-	-	-	-	-	-	-	-	-	-	-	-	-	-
Brill (Slethvarre )][Scophthalmus rhombus ]	-	-	-	-	-	-	-	-	-	-	-	-	-	-	-	-	-	-	-	-	-	-	-	-
Cardine franche (Glashvarre )][Lepidorhombus whiffiagonis ]	-	-	-	-	-	-	-	-	-	-	-	-	-	-	-	-	-	-	-	-	-	-	-	-
Cod (Torsk )][Gadus morhua ]	-	-	0.13	0.25	0.13	0.25	-	-	-	-	-	-	-	-	-	-	0.25	0.50	-	-	-	-	0.50	0.71
Dab (Ising )][Limanda limanda ]	4.00	3.19	2.00	0.91	1.63	1.25	3.00	0.41	2.88	2.02	3.75	2.33	2.63	1.44	1.75	0.96	1.88	0.63	26.50	9.19	29.50	17.68	21.00	7.07
Dover sole (Tunge )][Solea solea ]	0.25	0.50	0.13	0.25	0.25	0.29	-	-	0.25	0.29	0.50	0.71	-	-	0.25	0.50	0.25	0.29	1.50	2.12	1.50	0.71	2.00	2.83
Dragonnet (Fløjfisk (uspec) )][Callionymus spp. ]	-	-	-	-	-	-	-	-	-	-	-	-	-	-	-	-	-	-	-	-	-	-	-	-
Dragonnet lyre (Fløjfisk (str) )][Callionymus lyra ]	-	-	-	-	-	-	-	-	-	-	-	-	-	-	-	-	-	-	-	-	0.50	0.71	0.50	0.71
Dragonnet tacheté (Fløjfisk (pl) )][Callionymus maculatus ]	-	-	-	-	-	-	-	-	-	-	-	-	-	-	-	-	-	-	-	-	-	-	-	-
Flounder (Skrubbe )][Platichthys flesus ]	0.25	0.29	0.13	0.25	0.13	0.25	-	-	-	-	-	-	-	-	-	-	0.13	0.25	0.50	0.71	1.00	1.41	-	-
Gobies (Kutling )][Gobiidae ]	-	-	-	-	-	-	-	-	-	-	-	-	-	-	-	-	-	-	-	-	-	-	-	-
Goldsinny Wrasse (Havkarudse )][Ctenolabrus rupestris ]	-	-	-	-	-	-	-	-	-	-	-	-	-	-	-	-	-	-	-	-	-	-	-	-
Herring (Sild )][Clupea harengus ]	0.13	0.25	0.13	0.25	-	-	0.13	0.25	-	-	-	-	0.13	0.25	0.63	1.25	0.13	0.25	-	-	0.50	0.71	-	-
Hook-nose (Ulk-panserulk )][Agonus cataphractus ]	0.50	1.00	0.25	0.50	0.13	0.25	0.13	0.25	0.13	0.25	0.25	0.50	0.50	0.71	0.25	0.29	0.88	0.85	5.00	1.41	4.50	2.12	4.00	2.83
Horse mackerel (Hestemakrel )][Trachurus trachurus ]	-	-	-	-	-	-	-	-	-	-	-	-	-	-	-	-	-	-	-	-	-	-	-	-
Lemon sole (Rødtunge )][Microstomus kitt ]	-	-	-	-	-	-	-	-	-	-	-	-	-	-	-	-	-	-	-	-	-	-	0.50	0.71
Lumpsucker (Stenbider )][Cyclopterus lumpus ]	-	-	-	-	-	-	-	-	-	-	-	-	-	-	-	-	-	-	-	-	-	-	-	-
Mackerel (Makrel )][Scomber scombrus ]	-	-	-	-	-	-	-	-	-	-	-	-	-	-	-	-	-	-	-	-	-	-	-	-
Plaice (Rødspætte )][Pleuronectes platessa ]	0.13	0.25	-	-	0.50	0.71	-	-	-	-	-	-	-	-	-	-	0.25	0.29	1.00	1.41	-	-	1.00	-
Pouting (Skægtorsk )][Trisopterus luscus ]	-	-	-	-	-	-	-	-	-	-	0.13	0.25	-	-	-	-	-	-	-	-	-	-	-	-
Rock gunnel (Tangspræl )][Pholis gunnellus ]	0.13	0.25	0.13	0.25	-	-	-	-	0.13	0.25	-	-	-	-	-	-	-	-	-	-	-	-	-	-
Saithe (Sej )][Pollachius virens ]	-	-	-	-	-	-	-	-	-	-	-	-	-	-	-	-	-	-	-	-	-	-	-	-
Sand eel (Tobis )][Ammodytidae ]	3.25	4.56	4.00	5.48	3.75	1.55	11.00	13.08	10.63	14.27	17.38	23.43	9.75	9.60	19.13	32.95	29.38	52.44	25.00	24.04	28.00	29.70	23.00	11.31
Sculpin (Ulk )][Myxocephalus spp. ]	-	-	-	-	0.13	0.25	-	-	0.13	0.25	0.13	0.25	-	-	0.13	0.25	-	-	-	-	-	-	-	-
Sea trout (Ørred )][Salmo trutta ]	-	-	-	-	-	-	-	-	-	-	-	-	-	-	-	-	-	-	-	-	-	-	-	-
Sprat (Brisling )][Sprattus sprattus ]	0.13	0.25	-	-	0.13	0.25	0.13	0.25	0.13	0.25	-	-	-	-	-	-	-	-	-	-	-	-	-	-
Three-spined stickleback(Hundestejle 3p )][Gasterosteus aculeatus ]	-	-	-	-	-	-	-	-	-	-	-	-	-	-	-	-	-	-	-	-	-	-	-	-
Turbot (Pighvarre )][Psetta maxima ]	-	-	-	-	-	-	-	-	-	-	-	-	-	-	-	-	-	-	-	-	-	-	-	-
Viviparous eelpout (Ålekvabbe )][Zoarces viviparus ]	-	-	-	-	-	-	-	-	-	-	-	-	-	-	-	-	-	-	-	-	-	-	-	-
Whiting (Hvilling )][Merlangius merlangius ]	0.63	0.95	1.25	1.50	1.13	1.11	0.50	0.41	1.00	1.22	0.88	0.25	0.38	0.25	0.38	0.48	0.25	0.50	-	-	1.00	-	2.50	2.12
Yellow gurnard (Knurhane (rød) )][Yellow gurnard ]	-	-	-	-	-	-	-	-	-	-	-	-	-	-	-	-	-	-	-	-	-	-	-	-

Autumn 2009 survey

Year:	55																						58						95						Impact					
	far		midt				near		far		midt		near		far		midt		near		far		midt		near															
	mean	sd	mean	sd	mean	sd	mean	sd	mean	sd	mean	sd	mean	sd	mean	sd	mean	sd	mean	sd	mean	sd	mean	sd	mean	sd														
Species (DK) [Latin]																																								
American plaice (Håising ) [Hippoglossoides platessoides]	-	-	-	-	-	-	-	-	-	0.25	0.50	-	-	0.25	0.50	0.25	0.50	-	-	-	-	-	-	0.10	0.22															
Brill (Slethvarre ) [Scophthalmus rhombus ]	-	-	-	-	-	-	-	-	-	-	-	-	-	-	-	-	-	-	-	0.10	0.22	-	-	0.05	0.11															
Cardine franche (Glashvarre ) [Lepidorhombus whiffiagonis ]	-	-	-	-	-	-	-	-	-	-	-	-	-	-	-	-	-	-	-	-	-	-	0.10	0.22																
Cod (Torsk ) [Gadus morhua ]	0.10	0.22	0.30	0.45	0.30	0.45	-	-	0.75	0.65	1.00	0.41	0.13	0.25	0.25	0.29	0.81	1.14	0.40	0.89	-	-	-	-																
Dab (Ising ) [Limanda limanda ]	2.55	2.36	0.90	0.55	2.05	1.23	1.06	0.83	0.25	0.20	0.75	0.74	2.06	1.94	1.19	1.21	1.69	1.97	2.30	2.64	3.25	2.27	2.00	0.59																
Dover sole (Tunge ) [Solea solea ]	-	-	0.05	0.11	-	-	-	-	-	-	-	-	0.13	0.25	-	-	-	-	-	-	-	-	-	-																
Dragonnet (Fløjfisk (uspec) ) [Callionymus spp. ]	-	-	-	-	-	-	-	-	-	-	-	-	0.13	0.25	-	-	-	-	0.40	0.89	-	-	-	-																
Dragonnet lyre (Fløjfisk (str) ) [Callionymus lyra ]	-	-	-	-	0.10	0.22	0.25	0.50	-	-	-	-	-	-	-	-	-	-	-	-	-	-	-	-																
Dragonnet tacheté (Fløjfisk (pl) ) [Callionymus maculatus ]	-	-	-	-	-	-	-	-	-	-	-	-	-	-	-	-	-	-	-	-	-	-	0.10	0.22																
Flounder (Skrubbe ) [Platichthys flesus ]	-	-	-	-	0.05	0.11	-	-	-	-	-	-	0.06	0.13	-	-	-	-	-	-	0.05	0.11	-	-																
Gobies (Kutling ) [Gobiidae ]	-	-	-	-	-	-	-	-	-	-	-	-	-	-	-	-	-	-	0.40	0.89	-	-	-	-																
Goldsinny Wrasse (Havkarudse ) [Ctenolabrus rupestris ]	-	-	-	-	-	-	-	-	-	-	0.13	0.25	-	-	-	-	2.13	2.84	-	-	-	-	-	-																
Herring (Sild ) [Clupea harengus ]	0.30	0.67	0.40	0.89	0.60	0.89	-	-	0.75	1.50	0.25	0.29	0.31	0.47	0.25	0.50	0.06	0.13	-	-	0.10	0.22	-	-																
Hook-nose (Ulke-panserulke ) [Agonus cataphractus ]	0.20	0.45	0.20	0.45	-	-	0.25	0.50	0.25	0.50	-	-	0.38	0.75	-	-	0.25	0.29	-	-	0.20	0.27	-	-																
Horse mackerel (Hestemakrel ) [Trachurus trachurus ]	-	-	-	-	-	-	0.25	0.50	-	-	-	-	-	-	-	-	-	-	-	-	0.20	0.45	-	-																
Lemon sole (Rødtunge ) [Microstomus kitt ]	-	-	-	-	-	-	-	-	-	-	-	-	-	-	-	-	-	-	-	-	0.05	0.11	-	-																
Lumpsucker (Stenbider ) [Cyclopterus lumpus ]	-	-	-	-	-	-	-	-	-	-	-	-	-	-	-	-	-	-	-	-	-	-	-	-																
Mackerel (Makrel ) [Scomber scombrus ]	0.10	0.22	0.20	0.45	0.40	0.89	-	-	0.19	0.24	0.13	0.25	0.13	0.14	-	-	0.13	0.25	0.10	0.22	0.25	0.35	0.25	0.35																
Plaice (Rødspætte ) [Pleuronectes platessa ]	0.20	0.45	0.20	0.45	-	-	-	-	-	-	-	-	-	-	-	-	-	-	-	-	-	-	0.10	0.22																
Pouting (Skægtorsk ) [Trisopterus luscus ]	-	-	-	-	-	-	-	-	-	-	0.63	1.25	-	-	-	-	0.38	0.75	-	-	-	-	-	-																
Rock gunnel (Tangspræl ) [Pholis gunnellus ]	-	-	-	-	-	-	-	-	0.25	0.50	-	-	-	-	-	-	-	-	-	-	-	-	-	-																
Saithe (Sej ) [Pollachius virens ]	-	-	-	-	-	-	-	-	-	-	0.13	0.25	-	-	-	-	-	-	-	-	-	-	-	-																
Sand eel (Tobis ) [Ammodytidae ]	0.80	1.10	1.00	1.73	0.60	0.89	8.31	7.02	4.25	3.86	6.13	6.36	1.00	2.00	0.50	0.58	0.50	0.58	-	-	0.20	0.45	0.40	0.55																
Sculpin (Ulke ) [Myxocephalus spp. ]	0.20	0.45	-	-	-	-	-	-	-	-	0.13	0.25	-	-	-	-	-	-	-	-	-	-	-	-																
Sea trout (Ørred ) [Salmo trutta ]	-	-	-	-	-	-	-	-	-	-	-	-	-	-	-	-	-	-	-	-	-	-	-	-																
Sprat (Brisling ) [Sprattus sprattus ]	-	-	-	-	-	-	-	-	-	-	-	-	-	-	-	-	-	-	-	-	-	-	0.20	0.45																
Three-spined stickleback (Hundestejle 3p ) [Gasterosteus aculeatus ]	-	-	-	-	-	-	-	-	-	-	-	-	-	-	-	-	-	-	-	-	-	-	-	-																
Turbot (Pighvarre ) [Psetta maxima ]	-	-	-	-	-	-	-	-	-	-	0.06	0.13	0.06	0.13	-	-	0.06	0.13	-	-	0.05	0.11	-	-																
Viviparous eelpout (Ålekvabbe ) [Zoarces viviparus ]	-	-	-	-	-	-	-	-	-	-	0.13	0.25	-	-	-	-	0.13	0.25	-	-	-	-	-	-																
Whiting (Hvilling ) [Merlangius merlangius ]	1.10	1.29	0.90	1.52	0.50	0.71	0.50	0.71	0.63	0.95	1.50	1.08	6.13	6.70	2.50	2.55	2.75	3.33	0.80	1.30	1.30	0.57	1.20	1.30																
Yellow gurnard (Knurhane (rød) ) [Yellow gurnard ]	0.10	0.22	-	-	-	-	-	-	-	-	-	-	-	-	-	-	-	-	-	-	-	-	-	-																

Spring 2010 survey

Year: 2010	55						58						95						Impact											
	far		midt		near		far		midt		near		far		midt		near		far		midt		near							
	mean	sd	mean	sd	mean	sd	mean	sd	mean	sd	mean	sd	mean	sd	mean	sd	mean	sd	mean	sd	mean	sd	mean	sd						
Species (DK) [Latin]																														
American plaice (Håising ) [Hippoglossoides platessoides]	-	-	-	-	-	-	-	-	-	-	-	-	-	-	-	-	-	-	-	-	-	-	-	-	-	-	-	-	-	-
Brill (Slethvarre ) [Scophthalmus rhombus ]	-	-	-	-	-	-	-	-	-	-	-	-	-	-	-	-	-	-	-	-	-	-	-	-	-	-	-	-	-	-
Cardine franche (Glashvarre ) [Lepidorhombus whiffiagonis ]	-	-	-	-	-	-	-	-	-	-	-	-	-	-	-	-	-	-	-	-	-	-	-	-	-	-	-	-	-	-
Cod (Torsk ) [Gadus morhua ]	-	-	-	-	0.13	0.25	-	-	-	-	-	-	-	-	-	-	0.33	0.58	-	-	-	-	-	-	-	-	-	-	-	-
Dab (Ising ) [Limanda limanda ]	0.38	0.53	-	-	0.13	0.25	-	-	-	-	0.17	0.29	0.25	0.50	-	-	-	-	0.50	0.71	-	-	0.67	0.58	-	-	-	-	-	-
Dover sole (Tunge ) [Solea solea ]	-	-	-	-	-	-	-	-	-	-	-	-	-	-	-	-	-	-	-	-	-	-	-	-	-	-	-	-	-	-
Dragonnet (Fløjfisk (uspec) ) [Callionymus spp. ]	-	-	-	-	-	-	-	-	-	-	-	-	-	-	-	-	-	-	-	-	-	-	-	-	-	-	-	-	-	-
Dragonnet lyre (Fløjfisk (str) ) [Callionymus lyra ]	-	-	-	-	-	-	-	-	-	-	-	-	-	-	-	-	-	-	-	-	-	-	-	-	-	-	-	-	-	-
Dragonnet tacheté (Fløjfisk (pl) ) [Callionymus maculatus ]	-	-	-	-	-	-	-	-	-	-	-	-	-	-	-	-	-	-	-	-	-	-	-	-	-	-	-	-	-	-
Flounder (Skrubbe ) [Platichthys flesus ]	-	-	-	-	-	-	-	-	-	-	-	-	-	-	-	-	-	-	-	-	-	-	-	-	-	-	-	-	-	-
Gobies (Kutling ) [Gobiidae ]	-	-	-	-	-	-	-	-	-	-	-	-	-	-	-	-	-	-	-	-	-	-	-	-	-	-	-	-	-	-
Goldsinny Wrasse (Havkarudse ) [Ctenolabrus rupestris ]	-	-	-	-	-	-	-	-	-	-	-	-	-	-	-	-	-	-	-	-	-	-	-	-	-	-	-	-	-	-
Herring (Sild ) [Clupea harengus ]	0.50	0.71	0.33	0.58	0.25	0.50	1.00	-	0.67	0.58	-	-	0.25	0.50	1.00	1.00	0.83	0.76	-	-	2.00	-	1.00	1.00	-	-	-	-	-	-
Hook-nose (Ulke-panserulke ) [Agonus cataphractus ]	0.50	-	0.83	1.04	0.75	0.96	-	-	-	-	0.33	0.58	0.50	0.58	0.33	0.58	1.00	1.73	1.00	1.41	-	-	0.67	1.15	-	-	-	-	-	-
Horse mackerel (Hestemakrel ) [Trachurus trachurus ]	-	-	-	-	-	-	-	-	-	-	-	-	-	-	-	-	-	-	-	-	-	-	-	-	-	-	-	-	-	-
Lemon sole (Rødtunge ) [Microstomus kitt ]	-	-	-	-	-	-	-	-	-	-	-	-	-	-	-	-	-	-	-	-	-	-	-	-	-	-	-	-	-	-
Lumpsucker (Stenbider ) [Cyclopterus lumpus ]	-	-	-	-	-	-	-	-	-	-	-	-	-	-	-	-	0.08	0.14	-	-	-	-	-	-	-	-	-	-	-	-
Mackerel (Makrel ) [Scomber scombrus ]	-	-	-	-	-	-	-	-	-	-	-	-	-	-	-	-	-	-	-	-	-	-	-	-	-	-	-	-	-	-
Plaice (Rødspætte ) [Pleuronectes platessa ]	-	-	0.17	0.29	0.13	0.25	-	-	-	-	-	-	-	-	-	-	0.17	0.29	0.25	0.35	-	-	-	-	-	-	-	-	-	-
Pouting (Skægtorsk ) [Trisopterus luscus ]	-	-	-	-	-	-	-	-	-	-	-	-	-	-	-	-	-	-	-	-	-	-	-	-	-	-	-	-	-	-
Rock gunnel (Tangspræl ) [Pholis gunnellus ]	-	-	0.33	0.58	-	-	-	-	-	-	-	-	-	-	-	-	-	-	-	-	-	-	-	-	-	-	-	-	-	-
Saithe (Sej ) [Pollachius virens ]	-	-	-	-	-	-	-	-	-	-	-	-	-	-	-	-	-	-	-	-	-	-	-	-	-	-	-	-	-	-
Sand eel (Tobis ) [Ammodytidae ]	-	-	-	-	0.25	0.50	-	-	-	-	-	-	-	-	-	-	-	-	-	-	-	-	-	-	-	-	-	-	-	-
Sculpin (Ulke ) [Myxocephalus spp. ]	-	-	-	-	-	-	-	-	-	-	-	-	0.50	0.58	-	-	-	-	-	-	-	-	-	-	-	-	-	-	-	-
Sea trout (Ørred ) [Salmo trutta ]	-	-	-	-	-	-	-	-	0.33	0.58	-	-	-	-	-	-	-	-	-	-	-	-	-	-	-	-	-	-	-	-
Sprat (Brisling ) [Sprattus sprattus ]	-	-	0.33	0.58	-	-	1.00	1.41	-	-	2.00	2.00	-	-	-	-	-	-	-	-	-	-	-	-	-	-	-	-	-	-
Three-spined stickleback (Hundestejle 3p ) [Gasterosteus aculeatus ]	-	-	0.33	0.58	0.25	0.50	-	-	0.33	0.58	-	-	-	-	-	-	-	-	-	-	-	-	-	-	-	-	-	-	-	-
Turbot (Pighvarre ) [Psetta maxima ]	-	-	-	-	-	-	-	-	-	-	-	-	-	-	-	-	-	-	-	-	-	-	-	-	-	-	-	-	-	-
Viviparous eelpout (Ålekvabbe ) [Zoarces viviparus ]	-	-	-	-	-	-	-	-	-	-	-	-	-	-	-	-	-	-	-	-	-	-	-	-	-	-	-	-	-	-
Whiting (Hvilling ) [Merlangius merlangius ]	-	-	-	-	-	-	-	-	-	-	-	-	-	-	-	-	-	-	-	-	-	-	-	-	-	-	-	-	-	-
Yellow gurnard (Knurhane (rød) ) [Yellow gurnard ]	-	-	-	-	-	-	-	-	-	-	-	-	-	-	-	-	-	-	-	-	-	-	-	-	-	-	-	-	-	-

## APPENDIX V

Appendix V. Minimum (min), maximum (max), average (mean), standard deviation (std) and number of observations (N standardized) on total length (cm) on surveys (year) and area.

Before

year	area	species	latin	DK	min (cm)	max (cm)	mean (cm)	std	N standard	
2001	Control	Cod	Gadus morhua	Torsk	14.0	15.0	14.3	1.08	6	
		Dab	Limanda limanda	Ising	14.0	26.0	20.8	1.39	84	
		Dover sole	Solea solea	Tunge	19.0	22.0	20.3	1.11	6	
		Dragonnet lyre	Callionymus lyra	Fløjfisk (str)	10.0	10.0	10.0	1.00	2	
		Hook-nose	Agonus cataphractus	Ulk-panserulk	10.0	16.0	13.6	1.35	40	
		Mediterranean scaldfish	Arnoglossus laterna	Tungehvarre	9.0	16.0	11.4	1.64	8	
		Plaice	Pleuronectes platessa	Rødspætte	10.0	34.0	14.2	2.23	34	
		Rock gunnel	Pholis gunnellus	Tangspræl	16.0	16.0	16.0	1.00	2	
		Sand eel	Ammodytidae	Tobis	12.0	17.0	14.7	1.35	10	
		Sculpin	Myxocephalus spp.	Ulk	15.0	15.0	15.0	1.00	2	
		Solenette	Buglossidium luteum	Glastunge	8.0	8.0	8.0	1.00	2	
		Turbot	Psetta maxima	Pighvarre	31.0	36.0	33.3	1.11	6	
		Whiting	Merlangius merlangius	Hvilling	8.0	22.0	13.4	2.30	500	
	Impact	Cod	Gadus morhua	Torsk	10.0	16.0	12.4	1.40	6	
		Dab	Limanda limanda	Ising	14.0	27.0	21.7	1.45	102	
		Dover sole	Solea solea	Tunge	18.0	33.0	20.7	1.40	44	
		Dragonnet	Callionymus spp.	Fløjfisk (uspec)	7.0	9.0	8.0	1.19	6	
		Dragonnet lyre	Callionymus lyra	Fløjfisk (str)	7.0	7.0	7.0	1.00	2	
		Flounder	Platichthys flesus	Skrubbe	29.0	38.0	33.1	1.21	6	
		Goby	Pomatoschistus minutus	Kutling-sand	1.0	1.0	1.0	1.00	0	
		Hook-nose	Agonus cataphractus	Ulk-panserulk	11.0	15.0	12.8	1.38	44	
		Horse mackerel	Trachurus trachurus	Hestemakrel	6.0	6.0	6.0	1.00	4	
		Mediterranean scaldfish	Arnoglossus laterna	Tungehvarre	10.0	10.0	10.0	1.00	2	
		Plaice	Pleuronectes platessa	Rødspætte	9.0	27.0	13.3	1.88	34	
		Rock gunnel	Pholis gunnellus	Tangspræl	13.0	13.0	13.0	1.00	2	
		Sand eel	Ammodytidae	Tobis	5.0	18.0	13.4	1.81	58	
		Sculpin	Myxocephalus spp.	Ulk	20.0	20.0	20.0	1.00	2	
		Small-spotted catshark	Scyliorhinus canicula	Rødhaj (småplet)	51.0	51.0	51.0	1.00	2	
		Solenette	Buglossidium luteum	Glastunge	9.0	9.0	9.0	1.00	2	
		Sprat	Sprattus sprattus	Brisling	1.0	1.0	1.0	1.00	0	
	Turbot	Psetta maxima	Pighvarre	36.0	36.0	36.0	1.00	4		
	Whiting	Merlangius merlangius	Hvilling	9.0	25.0	13.2	2.44	474		
	2002	Control	Cod	Gadus morhua	Torsk	17.0	17.0	17.0	1.00	2
			Dab	Limanda limanda	Ising	10.0	29.0	19.9	2.17	308
Dover sole			Solea solea	Tunge	8.0	35.0	17.5	2.55	20	
Dragonnet lyre			Callionymus lyra	Fløjfisk (str)	6.0	8.0	6.9	1.33	4	
Flounder			Platichthys flesus	Skrubbe	31.0	37.0	34.9	1.23	6	
Herring			Clupea harengus	Sild	19.0	19.0	19.0	1.00	2	
Hook-nose			Agonus cataphractus	Ulk-panserulk	8.0	16.0	12.8	1.52	54	
Lemon sole			Microstomus kitt	Rødtunge	8.0	8.0	8.0	1.00	2	
Plaice			Pleuronectes platessa	Rødspætte	10.0	28.0	20.2	1.96	8	
Sand eel			Ammodytidae	Tobis	12.0	19.0	14.7	1.80	304	
Whiting		Merlangius merlangius	Hvilling	12.0	29.0	16.2	1.52	14		
Impact				Andre arter	12.0	12.0	12.0	1.00	2	
		American plaice	Hippoglossoides platessoides	Håising	10.0	19.0	13.8	1.90	4	
		Cod	Gadus morhua	Torsk	14.0	22.0	17.0	1.31	8	
		Dab	Limanda limanda	Ising	9.0	29.0	21.9	2.12	372	
		Dover sole	Solea solea	Tunge	8.0	26.0	14.1	2.24	28	
		Flounder	Platichthys flesus	Skrubbe	19.0	38.0	30.0	1.46	10	
		Herring	Clupea harengus	Sild	7.0	23.0	11.9	1.89	20	
		Hook-nose	Agonus cataphractus	Ulk-panserulk	11.0	15.0	13.2	1.36	48	
		Plaice	Pleuronectes platessa	Rødspætte	7.0	26.0	11.6	2.06	14	
		Pouting	Trisopterus luscus	Skægtorsk	23.0	23.0	23.0	1.00	2	
		Rock gunnel	Pholis gunnellus	Tangspræl	12.0	17.0	14.8	1.30	6	
		Sand eel	Ammodytidae	Tobis	5.0	26.0	14.8	3.86	1724	
	Sculpin	Myxocephalus spp.	Ulk	13.0	20.0	17.7	1.43	8		
Sprat	Sprattus sprattus	Brisling	8.0	11.0	9.4	1.21	8			
Whiting	Merlangius merlangius	Hvilling	9.0	26.0	13.8	1.91	102			

After

year	area	species	latin	DK	min	max	mean	std	N
					(cm)	(cm)	(cm)		standard
2009	Control	American plaice	Hippoglossoides platessoide	Håising	13.5	13.5	13.5	1.00	1
		Brill	Scophthalmus rhombus	Slethvarre	22.5	24.5	23.5	1.04	1
		Cardine franche	Lepidorhombus whiffiagoni	Glashvarre	11.5	11.5	11.5	1.00	1
		Cod	Gadus morhua	Torsk	16.5	16.5	16.5	1.00	4
		Dab	Limanda limanda	Ising	12.0	30.0	21.9	1.28	71
		Dragonnet	Callionymus spp.	Fløjfisk (uspec)	12.0	12.0	12.0	1.00	2
		Dragonnet tacheté	Callionymus maculatus	Fløjfisk (pl)	16.0	16.0	16.0	1.00	1
		Flounder	Platichthys flesus	Skrubbe	33.0	33.0	33.0	1.00	0.5
		Gobies	Gobiidae	Kutling	15.5	15.5	15.5	1.00	2
		Herring	Clupea harengus	Sild	32.0	32.0	32.0	1.00	1
		Hook-nose	Agonus cataphractus	Ulk-panserulk	15.0	15.5	15.2	1.02	2
		Horse mackerel	Trachurus trachurus	Hestemakrel	26.0	26.0	26.0	1.00	2
		Lemon sole	Microstomus kitt	Rødtunge	34.5	34.5	34.5	1.00	0.5
		Mackerel	Scomber scombrus	Makrel	29.0	37.0	32.7	1.09	5.5
		Plaice	Pleuronectes platessa	Rødspætte	11.5	11.5	11.5	1.00	1
		Sand eel	Ammodytidae	Tobis	13.5	19.0	16.0	1.27	6
		Sprat	Sprattus sprattus	Brisling	1.0	1.0	1.0	1.00	2
	Turbot	Psetta maxima	Pighvarre	28.0	28.0	28.0	1.00	0.5	
	Whiting	Merlangius merlangius	Hvilling	10.5	37.0	16.3	1.40	26	
	Impact	American plaice	Hippoglossoides platessoide	Håising	5.0	11.0	8.5	2.49	6
		Cod	Gadus morhua	Torsk	10.0	35.5	14.7	1.46	30.5
		Dab	Limanda limanda	Ising	13.5	32.5	23.3	1.35	103
		Dover sole	Solea solea	Tunge	17.0	34.0	21.4	1.49	1.5
		Dragonnet	Callionymus spp.	Fløjfisk (uspec)	14.5	14.5	14.5	1.00	1
		Dragonnet lyre	Callionymus lyra	Fløjfisk (str)	8.5	15.0	10.3	1.59	3
		Flounder	Platichthys flesus	Skrubbe	34.0	34.5	34.2	1.01	1
		Goldsinny Wrasse	Ctenolabrus rupestris	Havkarudse	13.0	17.5	14.9	1.12	18
		Herring	Clupea harengus	Sild	7.0	38.5	16.5	1.96	21
		Hook-nose	Agonus cataphractus	Ulk-panserulk	10.0	17.0	13.2	1.36	12
		Horse mackerel	Trachurus trachurus	Hestemakrel	5.5	5.5	5.5	1.00	2
		Mackerel	Scomber scombrus	Makrel	32.0	45.0	38.4	1.10	9.5
		Plaice	Pleuronectes platessa	Rødspætte	9.5	12.0	10.3	1.21	3
		Pouting	Trisopterus luscus	Skægtorsk	14.0	18.5	16.4	1.11	8
		Rock gunnel	Pholis gunnellus	Tangspræl	13.0	13.0	13.0	1.00	2
Saithe		Pollachius virens	Sej	20.5	20.5	20.5	1.00	1	
Sand eel		Ammodytidae	Tobis	11.0	33.0	15.1	1.57	183.5	
Sculpin	Myoxcephalus spp.	Ulk	12.5	14.5	13.8	1.13	3		
Turbot	Psetta maxima	Pighvarre	24.5	34.5	30.5	1.14	1.5		
Viviparous eelpout	Zoarces viviparus	Ålekvabbe	14.5	21.5	17.7	1.32	2		
Whiting	Merlangius merlangius	Hvilling	6.0	25.0	14.7	1.55	138		
Yellow gurnard	Yellow gurnard	Knurhane (rød)	1.0	1.0	1.0	1.00	1		
2010	Impact	Cod	Gadus morhua	Torsk	17.5	18.0	17.7	1.02	2
		Dab	Limanda limanda	Ising	16.0	24.5	20.2	1.19	4
		Herring	Clupea harengus	Sild	6.5	29.5	19.0	1.71	19
		Hook-nose	Agonus cataphractus	Ulk-panserulk	8.5	17.0	13.4	1.36	19
		Lumpsucker	Cyclopterus lumpus	Stenbider	29.5	29.5	29.5	1.00	0.5
		Plaice	Pleuronectes platessa	Rødspætte	11.0	35.0	16.4	1.93	3
		Rock gunnel	Pholis gunnellus	Tangspræl	7.5	7.5	7.5	1.00	2
		Sand eel	Ammodytidae	Tobis	14.0	14.0	14.0	1.00	2
		Sculpin	Myoxcephalus spp.	Ulk	19.5	23.5	21.4	1.14	2
		Sea trout	Salmo trutta	Ørred	52.0	52.0	52.0	1.00	1
		Sprat	Sprattus sprattus	Brisling	10.5	11.5	10.9	1.08	10
		Three-spined stickleback	Gasterosteus aculeatus	Hundestejle 3p	6.0	6.5	6.3	1.10	6
		Control	Dab	Limanda limanda	Ising	8.0	23.0	14.0	1.70
	Herring		Clupea harengus	Sild	6.5	26.0	9.3	2.28	5
	Hook-nose		Agonus cataphractus	Ulk-panserulk	11.5	11.5	11.5	1.00	4
	Plaice		Pleuronectes platessa	Rødspætte	44.0	44.0	44.0	1.00	0.5

## APPENDIX VI

### Appendix VI. Sandeel biology and length distribution of *lesser sandeel* and *small sandeel* during 2002-2010 in the Horns Reef area.

The geographical distribution of *lesser sandeel* (also called Raitt's sandeel) is closely associated with well-oxygenated bottom substrate consisting of gravel or coarse sand in which they frequently bury at water depths of 20 to 100 meters (Reay, 1970). In these areas sandeels forage in schools on a range of available zooplankton including copepods (*Calanus*, *Pseudocalanus*, *Temora*), annelids and larvacea. Larger fish tend to target larger food items (Macer, 1966). Sandeels make both seasonal and diel shifts between the pelagic feeding arena and being buried in the sand refuge. The seasonal foraging window for adult *lesser sandeel* lasts for only two to four months during spring, with a peak in activity around May, leaving the rest of the year (~8 months) for overwintering. This distinct pattern is reflected in both the fishery and in the gut content of predators. Juvenile *lesser sandeel* have a prolonged feeding period compared to adults and large catches of age-0 sandeels have been reported as late as in December (Macer, 1966; Winslade, 1974a; Harris and Wanless, 1991; Kvist, *et al.*, 2001; Reeves, 1994).

*Lesser sandeel* is a capital breeder and spawns during a narrow time window around January 1<sup>st</sup>, and onset of gonad development (the transition to exogenous vitellogenesis) occurs in July/August, around the time at which foraging activity ceases and overwintering begins. In the southern North Sea 50% mature around age 1, while 50% maturity in the northern North Sea occurs around age 2 (Macer, 1966; Bergstad, *et al.*, 2001; Wright, *et al.*, 1996; Boulcott and Wright, 2008). The eggs stick to the substrate on the banks, often partly buried. They normally hatch during February and March. Following hatching, the larvae enter the pelagic environment and are found in most of the water column (Conway, *et al.*, 1997; Jensen, *et al.*, 2003). Metamorphosis occurs around June or around 33 to 90 days from the time of hatching and at a length of c. 45 mm (Wright, *et al.*, 1996). The newly metamorphosed juveniles settle into the habitats inhabited by the parental stock and juveniles from last year's cohort.

As abundant planktivorous fish *lesser sandeel* and *small sandeel* act as trophic carriers of energy in the system. Greater sandeel prey on other sandeels and may therefore act as an additional trophic level between planktivorous fish and larger predators (fish, mammals and birds) in the ecosystem (Furness, 1990; Hain, *et al.*, 1995; Furness, 2002; Frederiksen, *et al.*, 2005; Engelhard, *et al.*, 2008). Changes in spatial aggregations and dynamics of sandeel populations will reflect the utilisation of new habitats and importance for predators within the wind farm.

#### **Age of *lesser sandeel* and *small sandeel* (surveys 2002-2010)**

There appear to be significant differences in length distribution between the impact and control areas in 2004, 2009 and 2010. However, the frequencies are based on small sample sizes thus causing the statistical analyses to be largely inconclusive.

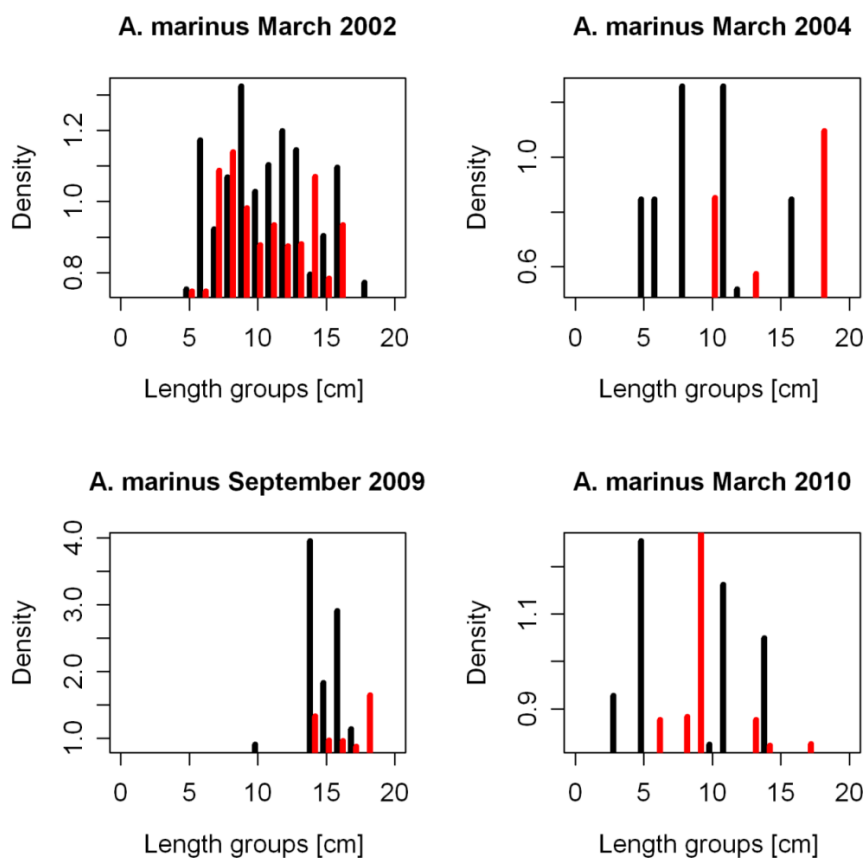

Appendix figure 1. Length distribution for lesser sandeel. Red bars refer to the control area. Black bars refer to the impact area.

Appendix table 1: Length and age at maturity and maximum age and length for sandeels (After (Wheeler, 1969).

Scientific name	Max. Length (cm)	Max. Age years	Maturity age	Maturity length (cm)
<i>Ammodytes marinus</i>	25	10	1-2	13
<i>Ammodytes tobianus</i>	20			
<i>Hyperoplus lanceolatus</i>	30		2	14



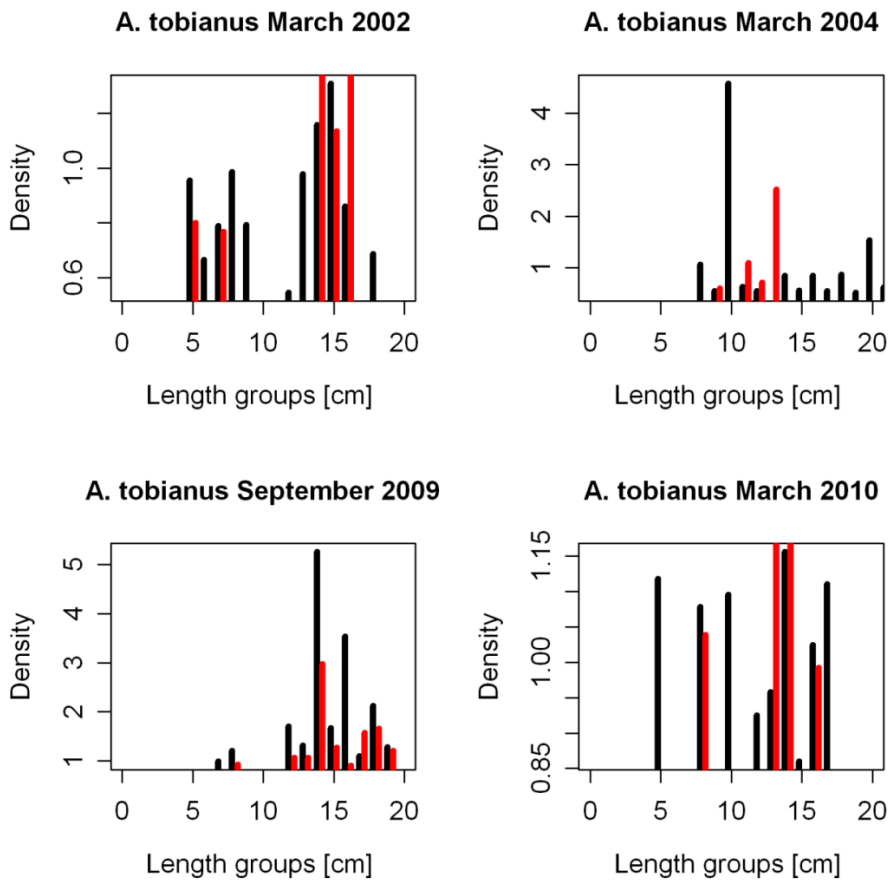

Appendix figure 2. Length distribution for small sandeel. Red bars refer to the control area. Black bars refer to the impact area.

## APPENDIX VII

### Appendix VII. Boot strap type approach to avoiding type II errors

In order to avoid committing type II errors in our conclusions, that is accepting the null-hypothesis where it should have been rejected, we assessed the power of the negative binomial model of sandeel-counts in samples.

**Technical details:**  $X$  number of random samples were simulated from each of two negative binomial distribution (here representing the impact and control area) that differed with respect to the mean number of counts per sample (the difference was control by adjusting the parameter  $\mu$  in the *rnbinom* function in R ([www.r-project.com](http://www.r-project.com))). The null-hypothesis - that abundance of fish is the same in the impact and control area - was then tested on the simulated data by calculating the p-value associated with the factor  $V_u$  in the negative binomial model (model 1 in the main text:  $\text{Log}E_{i,u} = \text{Log}(L_i) + V_u + S$  ).

The above procedure was repeated one thousand times, which resulted in one thousand p-values. The minimum p-value required to accept the null-hypothesis, was defined as the minimum p-value of the 5 % highest out the one thousand p-values, which corresponds to a significance level of 5 % (5 % possibility of accepting the null-hypothesis when it should have been rejected).

**Result:** We calculated the minimum p-value required to accept the null-hypothesis for various  $x_{\text{impact}}$  and  $x_{\text{control}}$  and various  $\mu_{\text{impact}}$  and  $\mu_{\text{control}}$ . The results of these calculations are summarized in the graph below, (Appendix figure 3) where the number of random samples increase with thickness of the graphs; going from 20 samples from each area to 60 samples (only the scenarios where  $x_{\text{impact}} = x_{\text{control}}$  is included). On the x-axis is the difference in fish abundance between the impact and control area.

Example of how to use the graph: Let's say you have 40 samples from the impact and control area respectively and get a p-value of 0.60, and you want to know with what statistical confidence you can accept the null-hypothesis based on this p-value. The value on the x-axis that corresponds to 0.6 on the y-axis via the third curve (40 samples) is the maximum difference between the impact and control area. Or in other words: With a p-value of 0.6 and a sample size of 40 you can accept a null-hypothesis stating that the fish abundance in the control area is not more than 80 % lower/higher than the fish abundance in the impact area (any differences  $< 80$  % between areas cannot be detected with statistical confidence at the 5 % significance level).

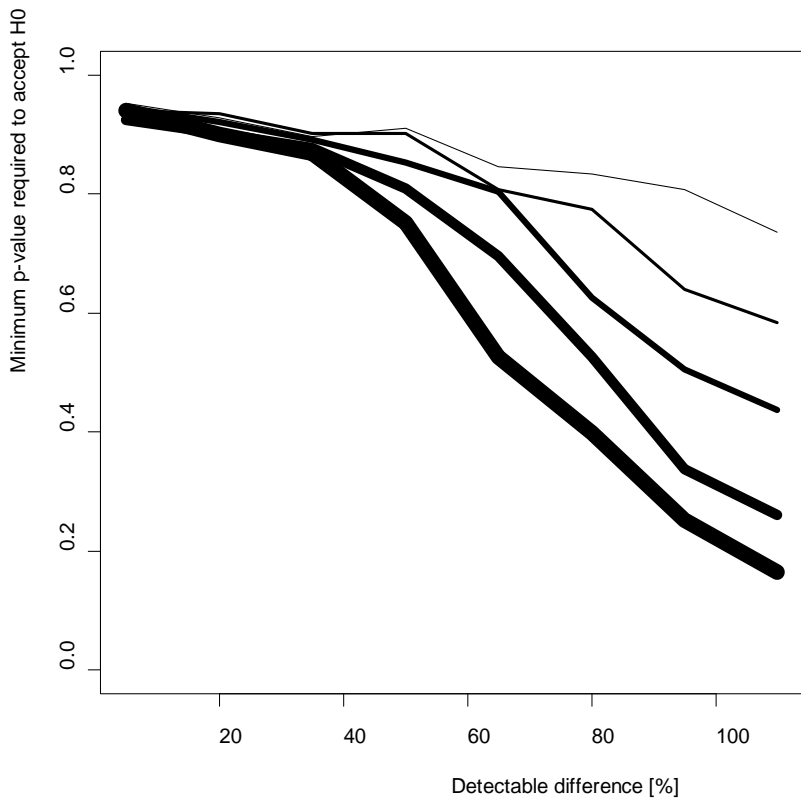

Appendix figure 3. Minimum p-value required to accept the null-hypothesis.

## APPENDIX VIII

### Appendix VIII. Test statistics. Fish communities

Appendix table 2. Horns Rev autumn fish community structure. R statistic and significant levels of ANOSIM similarity (Bray-Curtis) analyses. Significant R-values >0.5 are in bold. The highest R-values in each transformation are underscored. Not significant: ns.

Transformation	None (no)		Fourth- root (4r)		Present/absent (p/a)	
ANOSIM 2-way crossed with impact (I) and control (C) against before (B) and after (A) wind farm construction:						
	R	p	R	p	R	p
B/A (across I/C)	0.278	0.001	<u>0.246</u>	0.001	0.212	0.001
I/C (across B/A)	<u>0.297</u>	0.001	0.104	0.034	0.004	ns
ANOSIM 1-way of three impacted (I) stations (Stn. no. 55, 58, 95) and control (C) station before (B) and after (A).						
	R	p	R	p	R	p
Global	0.36	0.001	0.209	0.001	0.12	0.001
Groups, pairwise						
BC, B55	<b>0.885</b>	0.001	0.405	0.001	0.185	0.021
BC, B58	<b>0.885</b>	0.001	0.360	0.001	0.077	ns
BC, AC	<b>0.847</b>	0.001	<u>0.484</u>	0.001	<u>0.315</u>	0.002
BC, B95	<b>0.744</b>	0.001	0.405	0.001	0.093	ns
BC, A58	<b>0.661</b>	0.001	<u>0.485</u>	0.001	0.276	0.001
BC, A55	<b>0.650</b>	0.001	0.350	0.002	0.058	ns
B58, A58	<b>0.600</b>	0.001	0.355	0.001	0.228	0.001
B55, A58	<b>0.591</b>	0.001	<u>0.434</u>	0.001	<u>0.309</u>	0.001
B58, AC	<b>0.589</b>	0.001	0.394	0.001	<u>0.289</u>	0.001
A58, AC	<b>0.545</b>	0.001	0.323	0.001	0.18	0.005
B95, A58	0.470	0.001	0.374	0.001	0.273	0.001
B58, A55	0.425	0.001	0.289	0.001	0.199	0.009
BC, A95	0.412	0.001	0.405	0.001	0.161	0.035
Remaining groups: R<0.3.						

Appendix table 3. Horns Rev autumn and spring fish community structure. SIMPER analyses of dissimilarity (Euclidean distance) between the groups before (B) and after (A) wind farm construction, and between impact (I) and control sites, including all species that contribute with >0.5%.

Variable	Av. Value	Av. Value	Av. Sq. Dist	Sq. Dist/SD	Contrib%	Cum.%
<b>AUTUMN</b>						
Average squared distance: 148.03	Before (B)	After (A)				
<i>Merlangius merlangius</i>	8.770	1.570	120.00	0.21	81.15	81.15
Ammodytidae indet.	0.464	1.810	19.00	0.38	12.81	93.96
<i>Limanda limanda</i>	1.610	1.730	4.00	0.51	2.71	96.67
<i>Agonus cataphractus</i>	0.738	0.139	1.17	0.29	0.79	97.45
<i>Ctenolabrus rupestris</i>	0.000	0.167	0.99	0.18	0.67	98.12
Average squared distance: 372.07	Impact (I)	Control (C)				
<i>Merlangius merlangius</i>	2.600	11.100	339.00	0.34	91.05	91.05
Ammodytidae indet.	1.520	0.333	14.60	0.32	3.91	94.97
<i>Limanda limanda</i>	1.130	3.320	11.80	0.69	3.16	98.13
<i>Agonus cataphractus</i>	0.243	0.875	2.52	0.38	0.68	98.81
<b>SPRING</b>						
Average squared distance: 405.74	Before (B)	After (A)				
Ammodytidae indet.	7.200	1.190	321.00	0.22	79.06	79.06
<i>Merlangius merlangius</i>	4.770	1.020	57.20	0.15	14.09	93.15
<i>Limanda limanda</i>	3.760	1.190	23.20	0.17	5.71	98.86
Average squared distance: 675.62	Impact (I)	Control (C)				
<i>Merlangius merlangius</i>	1.620	7.600	287.00	0.31	42.54	42.54
Ammodytidae indet.	4.150	4.440	252.00	0.26	37.36	79.90
<i>Limanda limanda</i>	1.360	6.580	125.00	0.38	18.54	98.44
<i>Agonus cataphractus</i>	0.328	1.440	5.89	0.56	0.87	99.31

Appendix table 4. Horns Rev spring fish community structure. R statistic and significant level of ANOSIM similarity (Bray-Curtis) analyses. Significant R-values >0.5 are in bold. The highest R-values in each transformation are underscored. Not significant: ns.

Transformation	None (no)		Fourth- root (4r)		Present/absent (p/a)	
ANOSIM 2-way crossed with impact (I) and control (C) against before (B) and after (A) wind farm construction.						
	R	p	R	p	R	p
B/A (across I/C)*	0.717	0.001	0.731	0.001	0.680	0.001
I/C (across B/A)	0.381	0.001	0.260	0.002	0.043	ns
ANOSIM 1-way of three impacted (I) stations (Stn. no. 55, 58, 95) and control (C) station before (B) and after (A)						
	R	p	R	p	R	p
Global	0.449	0.001	0.444	0.001	0.386	0.001
Groups, pairwise						
B58, A58	<u>0.925</u>	0.001	<u>0.926</u>	0.002	<u>0.896</u>	0.1
B55, A58	<u>0.893</u>	0.003	<u>0.850</u>	0.001	<u>0.814</u>	0.1
B58, AC	<u>0.816</u>	0.001	<u>0.837</u>	0.001	<u>0.786</u>	0.1
BC, A58	<u>0.787</u>	0.004	<u>0.787</u>	0.002	<u>0.729</u>	0.4
BC, B55	<u>0.782</u>	0.001	0.314	0.004	-0.021	ns
B95, A58	<u>0.777</u>	0.001	<u>0.873</u>	0.002	<u>0.800</u>	0.2
B58, A55	<u>0.755</u>	0.001	<u>0.720</u>	0.001	<u>0.652</u>	0.1
B58, A95	<u>0.742</u>	0.001	<u>0.746</u>	0.001	<u>0.731</u>	0.1
B55, AC	<u>0.697</u>	0.001	<u>0.68</u>	0.001	<u>0.627</u>	0.1
B55, A95	<u>0.691</u>	0.001	<u>0.684</u>	0.001	<u>0.651</u>	0.1
B55, A55	<u>0.688</u>	0.001	<u>0.616</u>	0.001	<u>0.567</u>	0.1
BC, B58	<u>0.595</u>	0.001	<u>0.699</u>	0.001	0.377	0.3
B95, A55	<u>0.572</u>	0.002	<u>0.621</u>	0.001	<u>0.531</u>	0.1
B95, A95	<u>0.569</u>	0.001	<u>0.692</u>	0.001	<u>0.657</u>	0.1
B95, AC	<u>0.551</u>	0.001	<u>0.746</u>	0.001	<u>0.675</u>	0.1
BC, AC	<u>0.541</u>	0.002	<u>0.539</u>	0.002	0.493	0.2
BC, B95	0.465	0.002	0.433	0.003	0.081	ns
BC, A55	0.444	0.006	0.418	0.004	0.301	2.2
BC, A95	0.354	0.011	0.354	0.009	0.332	1.3
Remaining groups: R<0.3 or ns.						

Appendix table 5. Test statistics on negative binomial GLM model on effects of BA-CI design in fall and spring surveys. #NA indicated where statistical failed due to significant trends in residuals or where model could not converge.

Season	Species	Fixed effects	Estimate	Std. Error	z	value	Pr(> z )
Fall	Whiting	(Intercept)	2.504	0.417	6	2.00E-09	***
		CI	-1.342	0.475	-2.83	0.0047	**
		BA	-2.576	0.568	-4.54	5.80E-06	***
		BAxCI	1.559	0.654	2.38	0.0171	*
	Dab	(Intercept)	7.79E-01	0.3943	1.97	0.048	*
		CI	-1.1376	0.4611	-2.47	0.014	*
		BA	0.0883	0.5024	0.18	0.86	
		BAxCI	0.2523	0.5966	0.42	0.672	
	Sandeel	(Intercept)	-1.37E+00	0.8596	-1.6	0.11	
		CI	-8.41E-02	0.9798	-0.09	0.93	
		BA	-3.26E-01	1.135	-0.29	0.77	
		BAxCI	2.02E+00	1.2825	1.57	0.12	
	DEM	(Intercept)	0.921	0.288	3.2	0.0014	**
		CI	-0.836	0.336	-2.49	0.0128	*
		BA	-1.403	0.439	-3.2	0.0014	**
		BAxCI	1.093	0.501	2.18	0.0292	*
PEL	(Intercept)				#NA		
	CI				#NA		
	BA				#NA		
	BAxCI				#NA		
ROC	(Intercept)				#NA		
	CI				#NA		
	BA				#NA		
	BAxCI				#NA		

Appendix table 5, continued

Season	Species	Fixed effects	Estimate	Std. Error	z	value	Pr(> z )
Spring	Whiting	(Intercept)				#NA	
		CI				#NA	
		BA				#NA	
		BAxCI				#NA	
	Dab	(Intercept)	1.90E+00	0.2146	8.86	< 2e-16	***
		CI	-9.88E-01	0.2527	-3.91	9.30E-05	***
		BA	-3.89E+00	0.6485	-6	2.00E-09	***
		BAxCI	2.92E-02	0.8459	0.03	0.97	
	Sandeel	(Intercept)				#NA	
		CI				#NA	
		BA				#NA	
		BAxCI				#NA	
	DEM	(Intercept)	7.49E-01	0.276	2.71	0.0066	**
		CI	-1.068	0.334	-3.2	0.0014	**
		BA	-2.49	0.628	-3.96	7.30E-05	***
		BAxCI	1.816	0.696	2.61	0.009	**
	PEL	(Intercept)	-3.136	1.123	-2.79	0.0052	**
		CI	1.387	1.166	1.19	0.2344	
		BA	1.587	1.281	1.24	0.2154	
		BAxCI	-0.781	1.372	-0.57	0.5691	
	ROC	(Intercept)				#NA	
		CI				#NA	
		BA				#NA	
		BAxCI				#NA	



## APPENDIX IX

### Appendix IX. Sandeel distribution modelling.

Appendix table 6

Year	Area	Mean	Std. Dev	% >0,09mm	Std. Dev2	Kolonne3	% <0,09mm	Std. Dev.
2002	Control	1.008	0.29	99.458	22.558		0.542	0.298
2004	Control	1.164	0.275	99.291	59.14		0.709	0.66
2009	Control	1.186	0.341	99.273	7.704		0.727	0.32
2010	Control	1.153	0.346	99.196	3.812		0.804	0.37
2002	Impact	1.186	0.422	99.211	18.345		0.789	0.249
2004	Impact	0.967	0.315	98.886	6.052		1.114	0.238
2009	Impact	1.177	0.375	99.12	46.347		0.88	0.492
2010	Impact	0.997	0.436	99.172	9.748		0.828	0.206

Appendix table 7. Approximate significance of smooth terms for the model based on data from 2002.

	edf	Ref.df	F	p-value
s(Grain50)	1.115	1.221	3.816	0.043241 *
s(Depth)	1.000	1.000	11.801	0.000663 ***
s(Slope)	1.000	1.000	0.290	0.590335
s(Curvature)	1.000	1.000	0.009	0.922718

---

Signif. codes: 0 '\*\*\*' 0.001 '\*\*' 0.01 '\*' 0.05 '.' 0.1 ' ' 1

R-sq.(adj) = 0.0387 Deviance explained = 5.91%

GCV score = 0.0029445 Scale est. = 0.0029019 n = 354

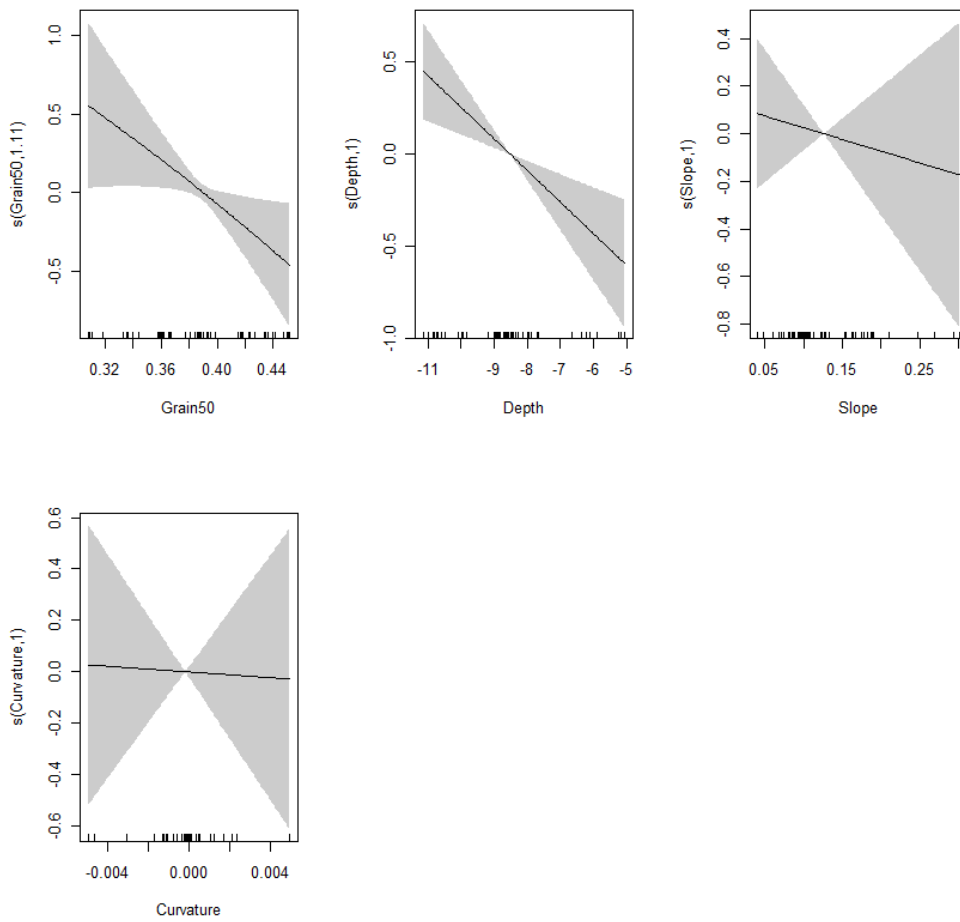

Appendix figure 4. Response curves of the GAM representing the relationship between the predictor variables and density of sandeels. The values of the environmental predictor are shown on the X-axis and the probability on the Y-axis in logit scale. The degree of smoothing is indicated in the title of the Y-axis. The shaded areas show  $\pm 1$  standard errors.

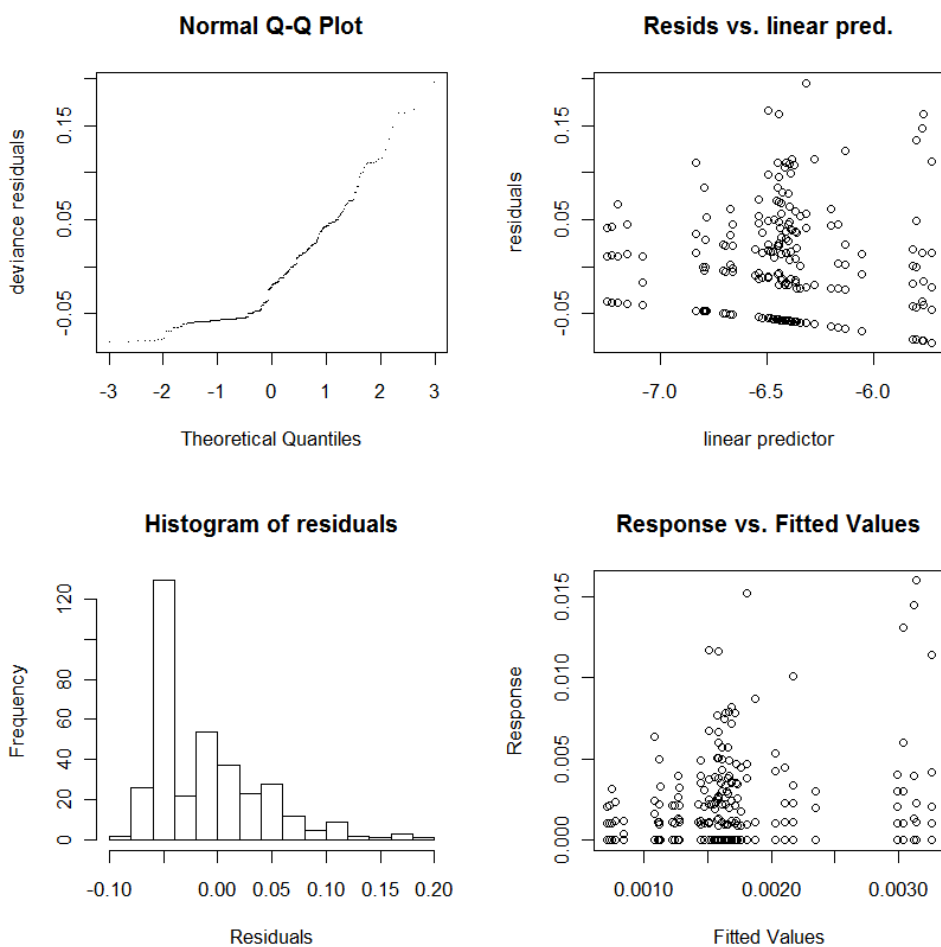

Appendix figure 5. Diagnostic plot of the GAM based on data from 2002. The plots to the left displays the “normality” of the residuals, the residuals should be normally distributed. Whereas the upper right plot shows” the distribution of the residuals”, no patterns should be expected. The lower right plot shows the predicted values against the observed values.

Appendix table 8. Approximate significance of smooth terms for the model based on data from 2002.

	edf	Ref.df	F	p-value
s(Grain50)	2.030	2.590	1.783	0.157334
s(Depth)	3.568	3.903	4.202	0.002524 **
s(Slope)	1.000	1.000	5.018	0.025432 *
s(Curvature)	3.691	3.936	5.573	0.000227 ***
s(dist2turb2)	3.793	3.968	5.101	0.000497 ***

---  
 Signif. codes: 0 '\*\*\*' 0.001 '\*\*' 0.01 '\*' 0.05 '.' 0.1 ' ' 1

R-sq.(adj) = 0.0594 Deviance explained = 20%  
 GCV score = 0.012734 Scale est. = 0.012423 n = 618

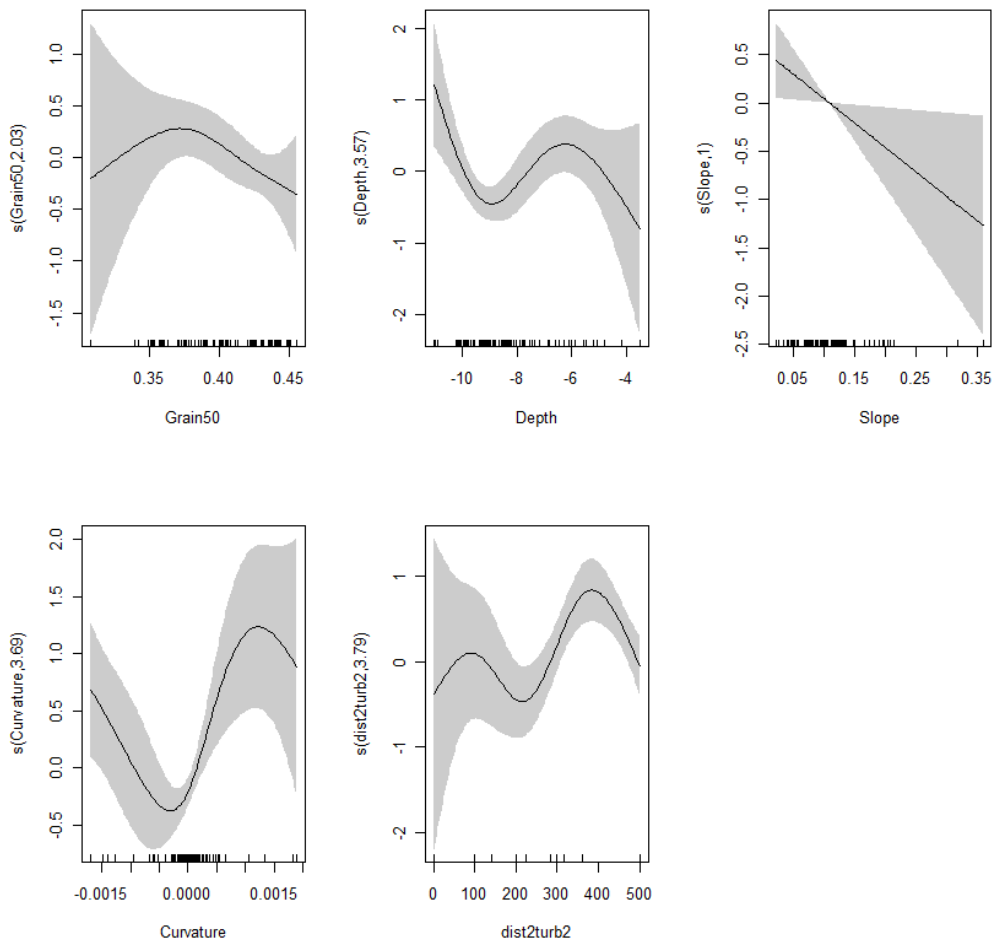

Appendix figure 6. Response curves of the GAM representing the relationship between the predictor variables and density of sandeels in the data from the years 2004, 2009 and 2010. The values of the environmental predictor are shown on the X-axis and the probability on the Y-axis in logit scale. The degree of smoothing is indicated in the title of the Y-axis. The shaded areas show  $\pm 1$  standard errors.

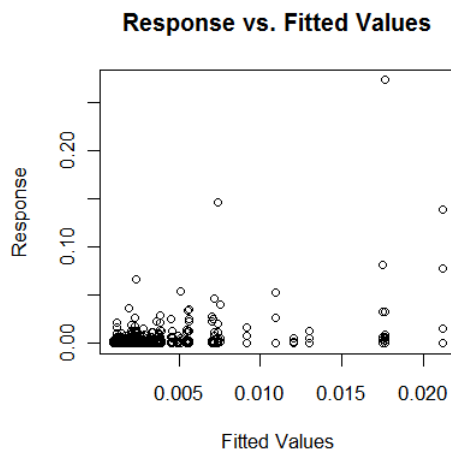
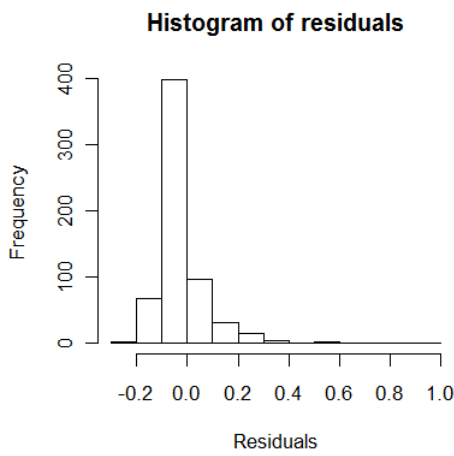
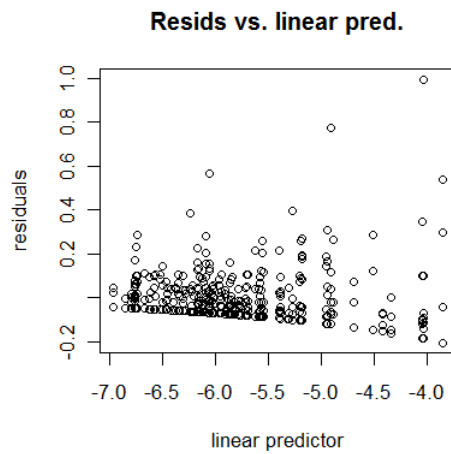
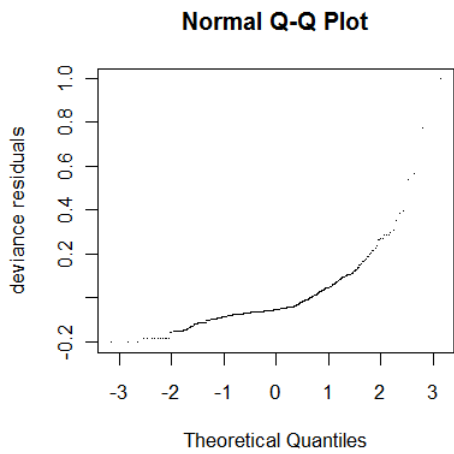

Appendix figure 7. Diagnostic plot of the GAM based on data from 2004, 2009 and 2010. The plots to the left displays the “normality” of the residuals, the residuals should be normally distributed. Whereas the upper right plot shows” the distribution of the residuals”, no patterns should be expected. The lower right plot shows the predicted values against the observed values.

APPENDIX X

Appendix X. Hydroacoustic statistics

Tests of Between-Subjects Effects

Dependent Variable:sqr\_sA

	Type III Sum of Squares	Df	Mean Square	F	Sig.
Corrected Model	1.604 <sup>a</sup>	15	.107	10.107	.000
Intercept	2.110	1	2.110	199.431	.000
Effect	.020	1	.020	1.928	.166
YEAR	.000	1	.000	.027	.870
YEAR_dir	.091	1	.091	8.557	.004
Day/Night	.302	1	.302	28.565	.000
Effect * YEAR	.001	1	.001	.071	.789
Effect * YEAR_dir	.003	1	.003	.256	.613
Effect * Day/Night	.021	1	.021	1.994	.159
YEAR * YEAR_dir	.139	1	.139	13.108	.000
YEAR * Day/Night	.044	1	.044	4.133	.043
YEAR_dir * Day/Night	.004	1	.004	.406	.524
Effect * YEAR * YEAR_dir	.002	1	.002	.196	.658
Effect * YEAR * Day/Night	2.165E-5	1	2.165E-5	.002	.964
Effect * YEAR_dir * Day/Night	.016	1	.016	1.480	.224
YEAR * YEAR_dir * Day/Night	.115	1	.115	10.849	.001
Effect * YEAR * YEAR_dir * Day/Night	.031	1	.031	2.895	.090
Error	4.592	434	.011		
Total	10.578	450			
Corrected Total	6.196	449			

a. R Squared = .259 (Adjusted R Squared = .233)

Cross-effects, therefore split the analysis by Direction (YEAR\_DIR)

YEAR\_dir = East-West survey

**Tests of Between-Subjects Effects<sup>b</sup>**

Dependent Variable:sqr\_sA

	Type III Sum of Squares	Df	Mean Square	F	Sig.
Corrected Model	.445 <sup>a</sup>	7	.064	7.050	.000
Intercept	.571	1	.571	63.289	.000
Effect	.016	1	.016	1.811	.180
YEAR	.054	1	.054	6.033	.015
Day/Night	.101	1	.101	11.186	.001
Effect * YEAR	.002	1	.002	.254	.615
Effect * Day/Night	.031	1	.031	3.489	.063
YEAR * Day/Night	.007	1	.007	.803	.371
Effect * YEAR * Day/Night	.014	1	.014	1.540	.216
Error	2.220	246	.009		
Total	4.087	254			
Corrected Total	2.665	253			

a. R Squared = .167 (Adjusted R Squared = .143) b. YEAR\_dir = East-West survey

YEAR\_dir = North-South survey

**Tests of Between-Subjects Effects<sup>b</sup>**

Dependent Variable:sqr\_sA

	Type III Sum of Squares	Df	Mean Square	F	Sig.
Corrected Model	.827 <sup>a</sup>	7	.118	9.359	.000
Intercept	1.833	1	1.833	145.274	.000
Effect	.005	1	.005	.390	.533
YEAR	.090	1	.090	7.158	.008
Day/Night	.226	1	.226	17.889	.000
Effect * YEAR	.000	1	.000	.015	.902
Effect * Day/Night	.000	1	.000	.019	.890
YEAR * Day/Night	.179	1	.179	14.184	.000
Effect * YEAR * Day/Night	.017	1	.017	1.371	.243
Error	2.372	188	.013		
Total	6.491	196			
Corrected Total	3.199	195			

a. R Squared = .258 (Adjusted R Squared = .231) b. YEAR\_dir = North-South survey

**YEAR = 2005, YEAR\_dir = East-West survey**

Tests of Between-Subjects Effects<sup>b</sup>

Dependent Variable:sqr\_sA

	Type III Sum of Squares	Df	Mean Square	F	Sig.
Corrected Model	.082 <sup>a</sup>	3	.027	2.289	.082
Intercept	1.317	1	1.317	110.545	.000
Effect	.009	1	.009	.722	.397
Day/Night	.073	1	.073	6.114	.015
Effect * Day/Night	.005	1	.005	.401	.528
Error	1.441	121	.012		
Total	3.037	125			
Corrected Total	1.523	124			

a. R Squared = .054 (Adjusted R Squared = .030)

b. YEAR = 2005, YEAR\_dir = East-West survey



YEAR = 2009, YEAR\_dir = East-West survey

**Tests of Between-Subjects Effects<sup>b</sup>**

Dependent Variable:sqr\_sA

	Type III Sum of Squares	df	Mean Square	F	Sig.
Corrected Model	.058 <sup>a</sup>	3	.019	3.105	.029
Intercept	.084	1	.084	13.453	.000
Effect	.009	1	.009	1.522	.220
Day/Night	.050	1	.050	7.998	.005
Effect * Day/Night	.027	1	.027	4.299	.040
Error	.779	125	.006		
Total	1.050	129			
Corrected Total	.837	128			

a. R Squared = .069 (Adjusted R Squared = .047)

b. YEAR = 2009, YEAR\_dir = East-West survey

YEAR = 2009, YEAR\_dir = North-South survey

**Tests of Between-Subjects Effects<sup>b</sup>**

Dependent Variable:sqr\_sA

	Type III Sum of Squares	df	Mean Square	F	Sig.
Corrected Model	.026 <sup>a</sup>	3	.009	.402	.752
Intercept	1.101	1	1.101	51.570	.000
Effect	.001	1	.001	.060	.808
Day/Night	.001	1	.001	.051	.822
Effect * Day/Night	.005	1	.005	.254	.616
Error	2.135	100	.021		
Total	4.770	104			
Corrected Total	2.160	103			

a. R Squared = .012 (Adjusted R Squared = -.018)

b. YEAR = 2009, YEAR\_dir = North-South survey

**Significance values for presence of turbines, within a distance of 100 m from turbine foundations**

sA (m2/ha) tracks				ID								
				2005			2009			Total		
				Diurnal			Diurnal			Diurnal		
				Day	Night	Total	Day	Night	Total	Day	Night	Total
				Mean	Mean	Mean	Mean	Mean	Mean	Mean	Mean	Mean
ID_dir	East-West survey	Effect	Between turbines	.013	.034	.023	.006	.010	.008	.009	.020	.015
			Within turbine buffer	.012	.044	.027	.000	.030	.008	.009	.042	.023
	North-South survey	Effect	Between turbines	.002	.032	.017	.040	.055	.047	.024	.045	.034
			Within turbine buffer	.001	.052	.023	.048	.034	.037	.012	.043	.029
	Total	Effect	Between turbines	.008	.033	.021	.021	.028	.025	.015	.030	.023
			Within turbine buffer	.008	.047	.025	.019	.033	.027	.010	.042	.026

## Colophon

### Effect of the Horns Rev 1 Offshore Wind Farm on Fish Communities

Follow-up Seven Years after Construction

December 2011

DTU Aqua Report No 246-2011

ISBN 978-87-7481-142-8

ISSN 1395-8216

#### *Editors*

Simon B. Leonhard<sup>2</sup>, Claus Stenberg<sup>1</sup> & Josianne Støttrup<sup>1</sup>

#### *Authors*

Claus Stenberg<sup>1</sup>, Michael van Deurs<sup>1</sup>, Josianne Støttrup<sup>1</sup>, Henrik Mosegaard<sup>1</sup>, Thomas Grome<sup>1</sup>, Grete Dinesen<sup>1</sup>, Asbjørn Christensen<sup>1</sup>, Henrik Jensen<sup>1</sup>, Maria Kaspersen<sup>1</sup>, Casper Willestofte Berg<sup>1</sup>, Simon B. Leonhard<sup>2</sup>, Henrik Skov<sup>3</sup>, John Pedersen<sup>2</sup>, Christian B. Hvidt<sup>4</sup> & Maks Klausstrup<sup>2</sup>

#### *Institutions*

<sup>1</sup> National Institute of Aquatic Resources, Technical University of Denmark, Jægersborg Allé 1, DK-2920 Charlottenlund, Denmark

<sup>2</sup> Orbicon A/S, Jens Juuls Vej 16, DK-8260 Viby J, Denmark

<sup>3</sup> Danish Hydraulic Institute (DHI), Agern Allé 5, DK-2970 Hørsholm, Denmark

<sup>4</sup> NaturFocus, Lystrupmindevej 26, Vrads, DK-8654 Bryrup, Denmark

#### *Photographers*

p. 4 Jens Christensen, Orbicon  
p. 6 Jens Christensen, Orbicon  
p. 8 upper Nysted Offshore Windfarm  
p. 8 lower Jens Christensen, Orbicon  
p. 12 Thomas Warnar, DTU Aqua  
p. 13 H. Sørensen, Fiskerforum.com  
p. 16 Jens Christensen, Orbicon  
p. 19 Claus Stenberg, DTU Aqua  
p. 22 Henrik Jensen, DTU Aqua  
p. 23 Thomas Warnar, DTU Aqua  
p. 30 Claus Stenberg, DTU Aqua  
p. 48 Claus Stenberg, DTU Aqua  
p. 51 Line Reeh, DTU Aqua  
p. 56 Christian B. Hvidt, Orbicon  
p. 57 Christian B. Hvidt, Orbicon

#### *Cover Design*

Peter Waldorff/Schultz Grafisk

Photo: Peter Jensen

#### *Reference*

Leonhard, S.B.; Stenberg, C. & Støttrup, J. (Eds.) 2011. Effect of the Horns Rev 1 Offshore Wind Farm on Fish Communities. Follow-up Seven Years after Construction. DTU Aqua, Orbicon, DHI, NaturFocus. Report commissioned by The Environmental Group through contract with Vattenfall Vindkraft A/S. DTU Aqua-report No 246-2011. National Institute of Aquatic Resources, Technical University of Denmark. 66 p.+ Appendices

**DTU Aqua reports** are published by the National Institute of Aquatic Resources and contain results from research projects etc. The views and conclusions are not necessarily those of the Institute.

The reports can be downloaded from [www.aqua.dtu.dk](http://www.aqua.dtu.dk).