

Evaluation of Survival and Behavior of Fish Exposed to an Axial-Flow Hydrokinetic Turbine

2014 TECHNICAL REPORT

Evaluation of Survival and Behavior of Fish Exposed to an Axial-Flow Hydrokinetic Turbine

EPRI Project Manager
P. Jacobson



3420 Hillview Avenue
Palo Alto, CA 94304-1338
USA

PO Box 10412
Palo Alto, CA 94303-0813
USA

800.313.3774
650.855.2121

askepri@epri.com

www.epri.com

3002003911

Final Report, April 2014

DISCLAIMER OF WARRANTIES AND LIMITATION OF LIABILITIES

THIS DOCUMENT WAS PREPARED BY THE ORGANIZATION(S) NAMED BELOW AS AN ACCOUNT OF WORK SPONSORED OR COSPONSORED BY THE ELECTRIC POWER RESEARCH INSTITUTE, INC. (EPRI). NEITHER EPRI, ANY MEMBER OF EPRI, ANY COSPONSOR, THE ORGANIZATION(S) BELOW, NOR ANY PERSON ACTING ON BEHALF OF ANY OF THEM:

(A) MAKES ANY WARRANTY OR REPRESENTATION WHATSOEVER, EXPRESS OR IMPLIED, (I) WITH RESPECT TO THE USE OF ANY INFORMATION, APPARATUS, METHOD, PROCESS, OR SIMILAR ITEM DISCLOSED IN THIS DOCUMENT, INCLUDING MERCHANTABILITY AND FITNESS FOR A PARTICULAR PURPOSE, OR (II) THAT SUCH USE DOES NOT INFRINGE ON OR INTERFERE WITH PRIVATELY OWNED RIGHTS, INCLUDING ANY PARTY'S INTELLECTUAL PROPERTY, OR (III) THAT THIS DOCUMENT IS SUITABLE TO ANY PARTICULAR USER'S CIRCUMSTANCE; OR

(B) ASSUMES RESPONSIBILITY FOR ANY DAMAGES OR OTHER LIABILITY WHATSOEVER (INCLUDING ANY CONSEQUENTIAL DAMAGES, EVEN IF EPRI OR ANY EPRI REPRESENTATIVE HAS BEEN ADVISED OF THE POSSIBILITY OF SUCH DAMAGES) RESULTING FROM YOUR SELECTION OR USE OF THIS DOCUMENT OR ANY INFORMATION, APPARATUS, METHOD, PROCESS, OR SIMILAR ITEM DISCLOSED IN THIS DOCUMENT.

REFERENCE HEREIN TO ANY SPECIFIC COMMERCIAL PRODUCT, PROCESS, OR SERVICE BY ITS TRADE NAME, TRADEMARK, MANUFACTURER, OR OTHERWISE, DOES NOT NECESSARILY CONSTITUTE OR IMPLY ITS ENDORSEMENT, RECOMMENDATION, OR FAVORING BY EPRI.

THIS REPORT WAS PREPARED AS AN ACCOUNT OF WORK SPONSORED BY AN AGENCY OF THE UNITED STATES GOVERNMENT. NEITHER THE UNITED STATES GOVERNMENT NOR ANY AGENCY THEREOF, NOR ANY OF THEIR EMPLOYEES, MAKES ANY WARRANTY, EXPRESS OR IMPLIED, OR ASSUMES ANY LEGAL LIABILITY OR RESPONSIBILITY FOR THE ACCURACY, COMPLETENESS, OR USEFULNESS OF ANY INFORMATION, APPARATUS, PRODUCT, OR PROCESS DISCLOSED, OR REPRESENTS THAT ITS USE WOULD NOT INFRINGE PRIVATELY OWNED RIGHTS. REFERENCE HEREIN TO ANY SPECIFIC COMMERCIAL PRODUCT, PROCESS, OR SERVICE BY TRADE NAME, TRADEMARK, MANUFACTURER, OR OTHERWISE DOES NOT NECESSARILY CONSTITUTE OR IMPLY ITS ENDORSEMENT, RECOMMENDATION, OR FAVORING BY THE UNITED STATES GOVERNMENT OR ANY AGENCY THEREOF. THE VIEWS AND OPINIONS OF AUTHORS EXPRESSED HEREIN DO NOT NECESSARILY STATE OR REFLECT THOSE OF THE UNITED STATES GOVERNMENT OR ANY AGENCY THEREOF.

THE FOLLOWING ORGANIZATION, UNDER CONTRACT TO EPRI, PREPARED THIS REPORT:

Alden Research Laboratory, Inc.

NOTE

For further information about EPRI, call the EPRI Customer Assistance Center at 800.313.3774 or e-mail askepri@epri.com.

Electric Power Research Institute, EPRI, and TOGETHER...SHAPING THE FUTURE OF ELECTRICITY are registered service marks of the Electric Power Research Institute, Inc.

Copyright © 2014 Electric Power Research Institute, Inc. All rights reserved.

Acknowledgments

The following organization, under contract to the Electric Power Research Institute (EPRI), prepared this report:

Alden Research Laboratory, Inc.
30 Shrewsbury Street
Holden, MA 01520-1843

Principal Investigators

S. Amaral
D. Giza
B. McMahan

This report describes research sponsored by EPRI.

This study was funded by the U.S. Department of Energy's Oak Ridge National Laboratory (ORNL) and EPRI. We are grateful to Glenn Cada and Mark Bevelhimer of ORNL for their valuable input and guidance in developing the study plan and helping us ensure that animal welfare requirements were met prior to conducting the study. Ed Lovelace (formerly with Free Flow Power) was instrumental in facilitating the acquisition of the test turbine, and he provided valuable technical guidance on the design and operation of the turbine. Tom Pham (Mass Maritime Academy) was very helpful in making the turbine available for this study. We would also like to thank Alabama Power for loaning Alden Research Laboratory the DIDSON acoustic camera that was used to record fish movements during "nighttime" tests. In addition to the principal Investigators, Alden personnel who made significant contributions to the performance and successful completion of this project included Nick Lucia, Jason Muise, and Scott St. Jean.

This publication is a corporate document that should be cited in the literature in the following manner:

*Evaluation of Survival and Behavior
of Fish Exposed to an Axial-Flow
Hydrokinetic Turbine.*
EPRI, Palo Alto, CA: 2014.
3002003911.

Abstract

Hydrokinetic turbines installed in riverine, tidal, and ocean habitats have the potential to impact fish populations, particularly if fish are entrained through operating units and suffer injury and mortality. A primary concern associated with the passage of fish through hydrokinetic turbines is the potential for fish to be struck by turbine blades. To address this issue, a laboratory evaluation was conducted to evaluate fish entrainment and turbine passage survival for an axial-flow turbine developed by Free Flow Power. Testing was conducted in a large flume at approach velocities of about 1.5 and 2.0 m/s. Test species included rainbow trout, hybrid striped bass, and white sturgeon. High turbine survival rates (98-100%) were observed for fish that passed through the turbine during tests in which a containment net prevented downstream movement around the unit. During behavioral trials conducted without the containment net, active avoidance of turbine entrainment was noted for trout and bass, whereas sturgeon appeared to move passively downstream with little or no attempts to avoid entrainment. Total passage survival estimates were calculated for each species and test velocity by combining turbine survival estimates and avoidance probabilities. Total survival was essentially 100% for all test conditions, with the exception of hybrid striped bass evaluated at a velocity of 1.5 m/s (94%). This study has produced valuable data that can be used to assess potential impacts of hydrokinetic turbine projects on fish populations.

Keywords

Hydrokinetic turbines
Fish entrainment
Fish survival

Executive Summary

Background and Objectives

The U.S. Department of Energy's (DOE) Wind & Water Power Program has recently provided considerable funding to marine and hydrokinetic technology developers and other industry partners to facilitate technology development, environmental review, and licensing and permitting. As part of this program, the Electric Power Research Institute (EPRI) was awarded a grant from the DOE in 2009 to determine the potential for injury and mortality to fish passing through hydrokinetic turbines and how these devices may impact fish movements and migrations. This initial study included a biological evaluation of two turbine designs in a large flume and provided valuable information on survival and behavior of fish passing through and around each unit. To expand on the results from these previous tests, EPRI and the DOE (through the Oak Ridge National Laboratory) provided funding to Alden Research Laboratory, Inc. (Alden) to conduct additional tests with a third turbine design. A ducted axial-flow propeller turbine developed by Free Flow Power Corporation (FFP) was selected for these tests, which were completed in the fall of 2012 and included survival and behavioral evaluations with rainbow trout, white sturgeon, and hybrid striped bass.

Methods

Biological testing was conducted with a ducted axial-flow hydrokinetic turbine developed by FFP. The turbine is 1.5 m in diameter and has seven blades. The expected rotational speeds for this unit range from 40 to 125 rpm at flow velocities of 1 to 3 m/s. The biological evaluation included two test types, one designed to estimate turbine passage survival and the other to assess behavioral interactions and avoidance as fish moved downstream and encountered the turbine.

Turbine passage survival was evaluated with the three species selected for testing using a paired release-recapture experimental design. Treatment groups were released into a containment net attached to the upstream side of the turbine to force fish to pass through the rotating blades when moving downstream. Control groups were introduced on the downstream side of the turbine immediately after treatment fish were released. Both groups were recovered from the

flume at the same time at the completion of each trial. Survival tests with each species were conducted at two approach velocities (1.5 and 2.0 m/s). Data analysis included assessments of immediate (1 hr) and delayed (48 hr) mortality and injury and scale loss. Immediate and total (immediate plus 48-hour) passage survival rates were estimated and statistically analyzed using a maximum likelihood estimation (MLE) model developed for paired release-recapture studies with a single recapture event (Burnham et al. 1987). Turbine survival and 95% confidence intervals were calculated using pooled-replicate data for each set of test conditions following procedures described by Skalski (1999).

Behavioral trials were designed to evaluate the ability of fish to actively avoid passing through the turbine when released farther upstream and without the containment net that was used for survival tests. Two light conditions (day and night) and three approach velocities were evaluated during these tests. Testing with a third approach velocity (1.1 m/s) during the behavioral evaluation was needed because the DIDSON acoustic camera could not provide viable images of fish at the higher velocities (1.5 and 2.0 m/s) due to excessive air entrainment in the flume. Consequently, testing with the nighttime lighting condition at the two higher velocities was dropped from behavioral evaluation and trials at 1.1 m/s approach velocity under day and nighttime lighting conditions were added. The analysis of behavioral data focused on qualitative observations of behavior as fish moved downstream past the turbine, as well as quantitative estimates of entrainment and avoidance rates.

Estimates of total passage survival for fish moving downstream past an FFP turbine were calculated using avoidance rates and turbine survival estimates for entrained fish. This provided an overall measure of survival for all fish that encounter a turbine and either pass downstream around or through it. The lower and upper limits of the 95% confidence intervals for turbine survival and avoidance estimates were used to calculate ranges of total passage survival for each species and test velocity.

Results

Survival Tests

Immediate and total turbine passage survival rates for rainbow trout were 100% for both size groups at the lower approach velocity and about 98% and greater for both size groups at the higher velocity. There was no apparent effect of fish length on survival for tests at either velocity. There also was no effect of velocity on survival for the smaller-size group, but survival of the larger trout was significantly greater at the lower test velocity than at the higher velocity ($P < 0.05$). The total percent of treatment fish recovered with visible external injuries was higher than it was for controls for both size

groups and test velocities. The injury rate of treatment fish also increased for both size groups at the higher velocity. When adjusted for control data, the percent of turbine-passed fish classified as descaled was 0.0% at the lower test velocity and 0.1% at the higher velocity for the smaller fish. Adjusted descaling rates for the large size group were higher and increased with velocity (9.5% at 1.5 m/s and 22.3% at 2.0 m/s).

Immediate and total turbine passage survival rates for hybrid striped bass were 98.0 and 91.1%, respectively, at the lower approach velocity and exceeded 100% at the higher velocity due to control mortality being greater than treatment fish mortality. The differences between immediate and total survival rates estimated for the two velocities were statistically insignificant ($P > 0.05$). The relatively low total survival rate (91.1%) estimated for bass tested at the 1.5 m/s test velocity was primarily due to a large number of delayed mortalities of treatment fish that occurred during one of the three trials. The cause for this high delayed mortality of treatment fish is unknown, but may have been related to an aberration in testing protocols or procedures that resulted in elevated stress and/or increased injury experienced by fish in this group. The injury rate for treatment fish was higher at the low velocity, which likely reflected the large number of mortalities that occurred during one trial. Injury rates for control fish were less than for treatment fish at the lower velocity, but greater at the higher velocity.

Immediate and total turbine passage survival rates for white sturgeon were 100% for both approach velocities evaluated. Total turbine survival at the lower velocity exceeded 100% due to control mortality being greater than treatment mortality. The percent of treatment and control fish recovered with visible external injuries increased with velocity. The injury rate of control fish was lower than it was for treatment fish at the 1.5 m/s test velocity, but was higher at 2.0 m/s.

Behavioral Tests

Avoidance of turbine entrainment by the two size groups of rainbow trout was high (> 85%) for all three test velocities and both light conditions evaluated at 1.1 m/s. Avoidance decreased with increasing velocity and was higher for tests conducted under darkened conditions (nighttime simulation at 1.1 m/s). Differences in turbine avoidance probabilities were not statistically significant among test velocities within each size group or between size groups within each velocity. Similarly, for both size groups, avoidance probabilities of trout were not statistically significant between the two light conditions evaluated.

Avoidance of turbine entrainment by sturgeon was also high (> 87%) for all three velocities and both light conditions. Unlike trout and hybrid striped bass, sturgeon avoidance appeared to be more passive

with minimal active swimming and directional movement. The differences between sturgeon avoidance rates at the two lower velocities tested under the lighted condition and between the two light conditions were not statistically significant.

Avoidance rates for hybrid striped bass were essentially the same at the lowest and highest velocities tested under daytime light conditions (about 59%), but considerably lower at the middle velocity (33%). However, due to high variability, the difference in avoidance among the three velocities was not statistically significant. There also was no statistical difference in avoidance rates between the two light conditions tested at the lower velocity.

Total Passage Survival

Both size groups of rainbow trout had total passage survival estimates of 100% at an approach velocity 1.5 m/s. At 2.1 m/s, total survival was greater than 99% for each size group. Total passage survival for white sturgeon was 100% at both test velocities due to 100% turbine survival at each velocity. Total survival for hybrid striped bass was 94% at the lower test velocity and 100% at the higher velocity. As discussed previously, one of the three trials conducted with bass at the lower velocity had higher delayed mortality than would normally be expected based on the results from tests at the higher velocity and with the other species. The ranges of total survival calculated with the lower and upper confidence intervals of turbine survival and avoidance estimates were very narrow for trout and sturgeon (lower limits were all greater than 98%), but wider ranges occurred for hybrid bass due to higher variability in the avoidance estimates among trials at each test velocity.

Conclusions

All of turbine passage survival tests conducted to date during lab and field evaluations have demonstrated high survival rates for the species and size groups evaluated (typically 98 to 100%). The behavioral tests conducted with the FFP turbine also demonstrated a high degree of turbine entrainment avoidance (86 to 100%) for two of three species evaluated and moderate rates of avoidance for the third species (32 to 65%). Also, for the one velocity evaluated under two light conditions, there was no difference in avoidance rates between daytime and nighttime conditions for any of the three species evaluated. Based on these results of this study, total passage survival for most fish encountering an FFP turbine at a field installation should be very high (99-100%).

Table of Contents

| | |
|---|------------|
| Section 1: Introduction | 1-1 |
| Section 2: Test Methods | 2-1 |
| Design and Operation of the Hydrokinetic Turbine Selected for Fish Testing | 2-1 |
| Free Flow Power (FFP) Turbine | 2-1 |
| Test Facility Design and Operation..... | 2-3 |
| Test Species and Fish Holding Facility Design and Operation | 2-8 |
| Experimental Design and Test Procedures | 2-10 |
| Survival Testing | 2-12 |
| Behavioral Testing | 2-14 |
| Data Analysis | 2-15 |
| Turbine Passage Survival | 2-15 |
| Injury and Descaling Attributed to Turbine Passage..... | 2-17 |
| Behavioral Analysis | 2-17 |
| Estimation of Total Passage Survival..... | 2-18 |
| Velocity Measurements | 2-18 |
| Section 3: Results | 3-1 |
| Survival Testing | 3-1 |
| Rainbow Trout..... | 3-1 |
| Hybrid Striped Bass | 3-6 |
| White Sturgeon | 3-9 |
| Behavioral Tests | 3-13 |
| Total Passage Survival Estimates | 3-22 |
| Section 4: Conclusions and Discussions | 4-1 |
| Section 5: Literature Cited | 5-1 |

List of Figures

| | |
|---|------|
| Figure 2-1 FFP's ducted axial-flow turbine installed in Alden's large flume test facility for the evaluation of fish survival and behavior (upstream side of turbine on left, downstream side on right)..... | 2-2 |
| Figure 2-2 Rotational speed versus approach flow velocity for the FFP turbine. | 2-3 |
| Figure 2-3 Alden's large flume fish testing facility configured for the biological evaluation of the FFP hydrokinetic turbine. | 2-5 |
| Figure 2-4 View downstream (A) and upstream (B) of the narrowed flume channel used for fish testing with hydrokinetic turbines. | 2-6 |
| Figure 2-5 Upstream side of the FFP turbine with fish release, enclosure net, and underwater camera locations used for turbine passage survival trials. Insert is view from above..... | 2-7 |
| Figure 2-6 Rainbow trout moving downstream on the upstream side of the FFP turbine during a behavioral trial. For these tests, the enclosure net was removed and the treatment fish release tube was moved to a position 1.45 m upstream from the turbine duct with the tube exit at the same depth as that used for survival tests. | 2-8 |
| Figure 2-7 Re-circulating aquaculture facility. | 2-10 |
| Figure 2-8 Diagram showing the body locations assessed for percent scale loss on all evaluated fish. | 2-14 |
| Figure 2-9 Velocity profile 3x3 grid showing locations of approach velocity measurements in the test flume channel..... | 2-19 |
| Figure 3-1 Rainbow trout (125 mm size group) showing avoidance behavior as they move downstream past the turbine at an approach velocity of 1.5 m/s (5 ft/s). | 3-16 |

Figure 3-2 Hybrid striped bass approaching the FFP turbine and passing downstream outside the turbine duct (fish circled on right) and entrained through the turbine (fish circled on left).....3-17

Figure 3-3 White sturgeon passively moving downstream over the turbine duct at an approach velocity 1.5 m/s (5 ft/s).3-18

Figure 3-4 Turbine avoidance rates by velocity and species for the lighted flume test condition (daylight simulation).3-20

Figure 3-5 Turbine avoidance by species for the darkened flume test condition (nighttime simulation). Tests with the darkened flume were only conducted at an approach velocity of 1.1 m/s.....3-21

List of Tables

| | |
|--|------|
| Table 2-1 Test conditions evaluated with the FFP turbine. Test species included rainbow trout (RBT) white sturgeon (WST) and hybrid striped bass (HSB). | 2-11 |
| Table 2-2 Average velocities measured at each channel and grid location at each test and velocity condition tested. Grid locations refer to those presented in Figure 2-9. | 2-20 |
| Table 3-1 Summary of fish release, recovery, and mortality data for rainbow trout tested during the survival evaluation with the FFP turbine. Fish that did not have a discernible mark (NM) when recovered at the end of a trial were excluded from the survival analysis. | 3-2 |
| Table 3-2 Turbine Passage survival estimates for rainbow trout evaluated with the FFP turbine. For comparisons with in each type of estimate (immediate and total), turbine survival estimates without a letter in common are significantly different ($P < 0.05$). | 3-3 |
| Table 3-3 Percent of rainbow trout observed with external injuries during survival testing. The number of treatment fish assessed includes both turbine-passed fish and any fish that remained in the containment net upstream of the turbine at the end of a trial because they could not be differentiated when fish were recovered from the flume. The sum of the percents for each injury type may be higher than the total percent injured because some fish suffered multiple injuries. | 3-4 |
| Table 3-4 Percent of rainbow trout classified as descaled during survival tests. The number of treatment fish assessed includes both turbine-passed fish and fish that remained in the containment net upstream of the turbine until at the end of each trial, which could not be differentiated when fish were recovered from the flume. | 3-5 |
| Table 3-5 Summary of fish release, recovery, and mortality data for hybrid striped bass tested during the survival evaluation with the FFP turbine. | 3-8 |

Table 3-6 Estimates of turbine passage survival (adjusted for control mortality) for hybrid striped bass evaluated with the FFP turbine. Survival rates greater than 100% resulted when control mortality was higher than treatment mortality. Turbine survival estimates were not significantly different ($P > 0.05$) between the two velocities tested.....3-9

Table 3-7 Percent of hybrid striped bass observed with external injuries during survival testing (T = treatment, C = control). The number of treatment fish assessed includes both turbine-passed fish and any fish that remained in the containment net upstream of the turbine at the end of a trial because they could not be differentiated when fish were recovered from the flume. For each test group (T and C), the sum of the percents for each injury type may be higher than the total percent injured because some fish suffered multiple injuries.3-10

Table 3-8 Percent of hybrid striped bass classified as descaled during survival tests.3-10

Table 3-9 Summary of fish released, turbine passed, recovered, and mortality data for white sturgeon tested during the survival evaluation (T = treatment, C = Control, NM= no identifiable mark).3-11

Table 3-10 Estimates of turbine passage survival (adjusted for control mortality) for white sturgeon evaluated with the FFP turbine. Survival rates greater than 100% resulted when control mortality was higher than treatment mortality. Turbine survival estimates were not significantly different ($P > 0.05$) between the two velocities tested.....3-12

Table 3-11 Percent of white sturgeon observed with external injuries during survival testing (T = treatment, C = control). The number of treatment fish assessed includes both turbine-passed fish and any fish that remained in the containment net upstream of the turbine until at the end of a trial because they could not be differentiated when fish were recovered from the flume. For each test group (T and C), the sum of the percents for each injury type may be higher than the total percent injured because some fish suffered multiple injuries.....3-12

Table 3-12 Summary of behavioral testing release and recovery data for rainbow trout (RBT), white sturgeon (WST), and hybrid striped bass (HSB) evaluated with the FFP turbine.3-15

Table 3-13 Turbine entrainment numbers and avoidance rate estimates from behavioral tests conducted with rainbow trout (RBT), white sturgeon (WST), and hybrid striped bass (HSB).3-19

Table 3-14 Estimated total passage survival calculated for each velocity tested with rainbow trout (RBT), white sturgeon (WST), and hybrid striped bass (HSB) using turbine survival and avoidance estimates.3-23

Table 4-1 Summary of design and survival data for fish passed through four different hydrokinetic turbines during lab and field tests. Tip strike velocities were estimated based on known (measured) design and operational parameters for the Free Flow, Welka UPG, and Lucid Spherical turbines, and from information provided by NAI (2009) for the Hydro Green turbine.4-3



Section 1: Introduction

The U.S. Department of Energy's (DOE) Wind & Water Power Program has recently provided considerable funding to marine and hydrokinetic technology developers and other industry partners to facilitate technology development, environmental review, and licensing and permitting. As part of this program, the Electric Power Research Institute (EPRI) was awarded a grant from the DOE in 2009 to determine the potential for injury and mortality to fish passing through hydrokinetic turbines and how these devices may impact fish movements and migrations. As part of this effort, Alden Research Laboratory, Inc. (Alden) conducted desktop and laboratory studies in 2010 investigating potential injury mechanisms, probability of blade strike, and survival of fish passing through hydrokinetic turbines. Laboratory studies of turbine passage survival were conducted with two different turbine designs: a spherical cross-flow turbine (Lucid Energy Technologies) and a horizontal-axis ducted unit (Welka UPG turbine) (EPRI 2011a).

Results from the 2010 flume studies demonstrated high survival rates (> 98%) for fish exposed to the two turbine designs and that fish were able to actively avoid turbine entrainment under the conditions evaluated (i.e., approach velocities of about 1.5 and 2.0 m/s and with overhead indoor lighting) (EPRI 2011a). Although the results may be representative of what would be expected for other turbine designs, additional testing with other hydrokinetic turbine designs will provide valuable data for developers and resource and regulatory agencies to make informed and timely decisions on potential impacts to fish. Also, all tests in 2010 were conducted with underwater and overhead lighting and good water clarity. Testing under simulated nighttime conditions (i.e., dark with no detectable light) would address concerns that fish may be more prone to turbine entrainment and blade strike when they are unable to use visual cues to detect and avoid passage through a turbine.

To expand on the study results from the previous flume testing with hydrokinetic turbines, the 2012 tests focused on survival testing of a third turbine design and behavioral testing under simulated daytime and nighttime light conditions. A ducted axial-flow propeller turbine developed by Free Flow Power Corporation (FFP) was selected for these tests. Similar to the evaluation of the two turbine designs in 2010, rainbow trout (*Oncorhynchus mykiss*) was the primary species evaluated during testing in 2012. However, testing was also conducted with white sturgeon (*Acipenser transmontanus*) juveniles because potential impacts to various sturgeon species, several of which are listed as threatened or endangered at the state and/or federal level, are a significant concern at many locations where

hydrokinetic turbines have been or are being considered for deployment (Mississippi River, Maine coastal areas, and several tidal areas on the East and West coasts). There also is evidence that injury and mortality rates associated with blade strike are significantly less for sturgeon (which have a cartilaginous skeleton) when compared to teleost species (i.e., fish with true bones) (Amaral et al. 2003, EPRI 2008, 2011b). In addition to rainbow trout and white sturgeon, hybrid striped bass (striped [*Morone saxatilis*] and white bass [*M. chrysops*] cross) were also tested with the Free Flow turbine. These species are common in coastal areas and rivers along the East Coast of the United States (striped bass also occur in many areas along the West Coast).



Section 2: Test Methods

Biological testing was conducted with a ducted axial-flow hydrokinetic turbine developed by Free Flow Power (FFP). Fish survival was estimated for the turbine and selected operating conditions (approach velocity and corresponding turbine rotational speed) by releasing test fish directly upstream and control fish downstream of the operating unit. Behavioral observations were recorded with underwater video cameras during survival tests and during separate trials where fish were released further upstream to allow them greater opportunity to avoid passage through the blade sweep of the turbine (within the confined space of the test channel). Additional behavioral trials were conducted with fish released upstream under dark conditions in which a DIDSON (Dual-Frequency Identification Sonar) acoustic camera was used to record behavioral observations. Detailed information on the turbines, test facility, and experimental design are provided below.

Design and Operation of the Hydrokinetic Turbine Selected for Fish Testing

Free Flow Power (FFP) Turbine

The FFP turbine used for the evaluation of fish survival and behavior in 2012 is a ducted axial-flow design with a diameter of 1.5 m (5 ft) (Figure 2-1). The turbine has seven blades and starts rotating at current velocities of about 0.9 m/s (3 ft/s). The expected rotational speeds for this unit range from 40 to 125 rpm at flow velocities of 1.5 to 3.0 m/s (5 to 10 ft/s) (Figure 2-2).

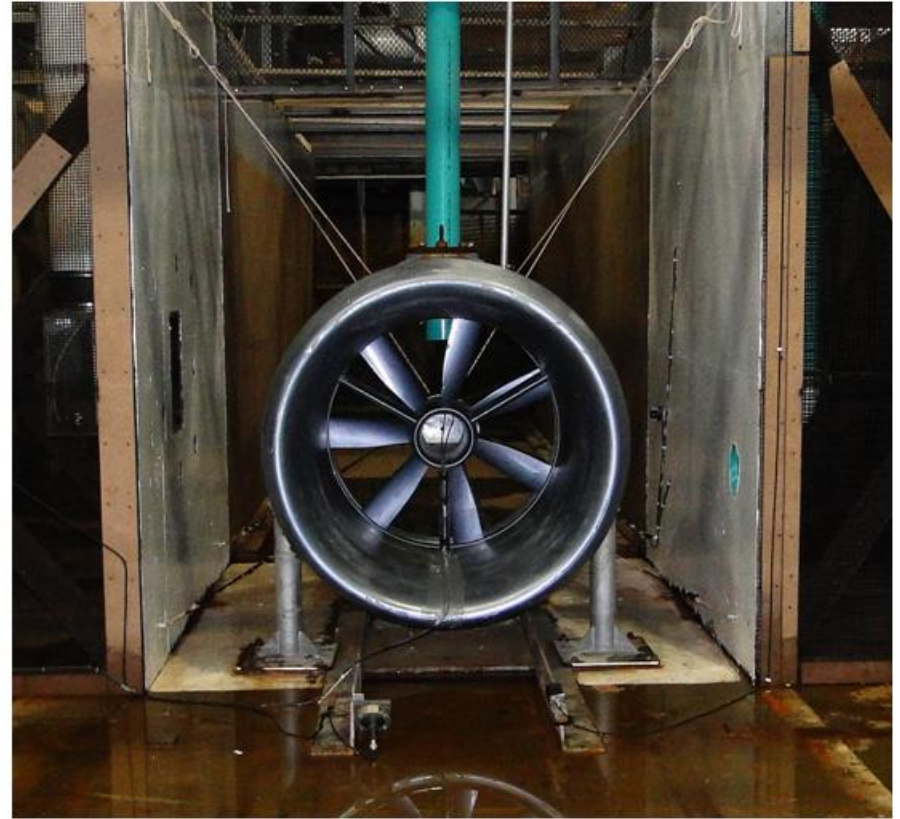

Figure 2-1
FFP's ducted axial-flow turbine installed in Alden's large flume test facility for the evaluation of fish survival and behavior (upstream side of turbine on left, downstream side on right)

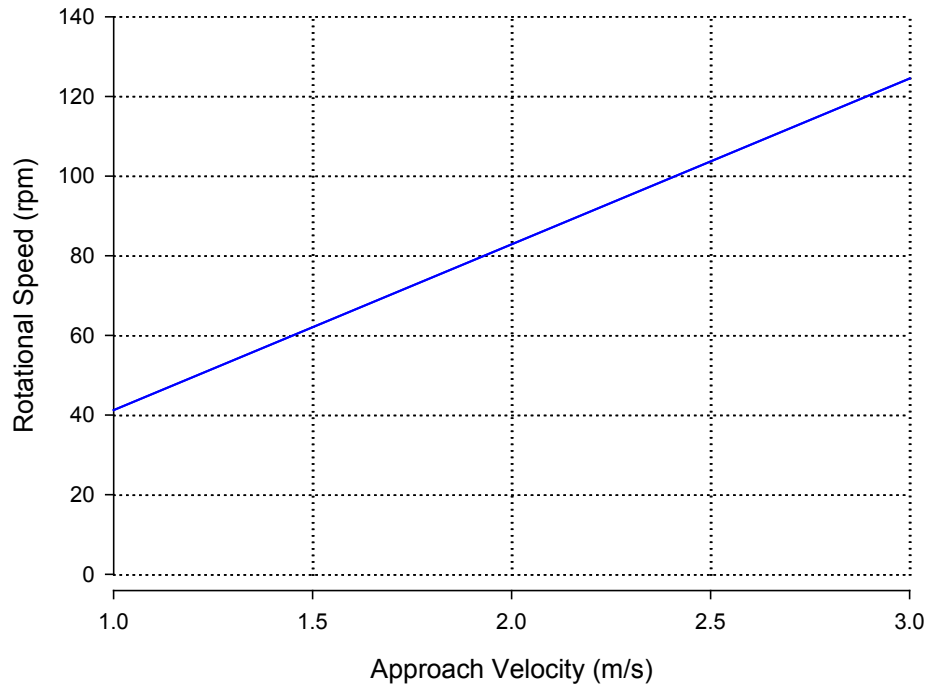

Figure 2-2
Rotational speed versus approach flow velocity for the FFP turbine.

Test Facility Design and Operation

The biological evaluation of the FFP turbine was conducted in Alden’s large re-circulating flume located in the Taft Fisheries Research and Test Facility building (Figure 2-3). The test flume has a concrete floor about 3.05 m (10 ft) below the top of the side walls. Located beneath this floor at the downstream end of the flume are two 1.7-m (66-in.) diameter bow-thrusters (400 hp each) capable of pumping up to 14.2 m³/s (500 cfs) through the test channel with the assistance of turning vanes at both ends (i.e., flume water is circulated vertically at either end of the flume). The length of flume available for testing is about 24.4 m (80 ft) with a total width of 6.1 m (20 ft) and maximum water depth of about 2.4 m (8 ft). In this configuration, the maximum channel velocity for the full width of the flume is about 0.91 m/s (3 ft/s). Higher flow velocities for testing the FFP turbine were achieved with temporary walls that narrowed the flume width to 2.4 m (8 ft) while maintaining the water depth at 2.4 m (Figure 2-3 and Figure 2-4). The maximum approach velocity that could be achieved for testing with the FFP turbine was about 2 m/s (6.5 ft/s), similar to previous fish testing with the Lucid and Welka UPG hydrokinetic turbine designs (EPRI 2011a). To minimize flow separation and turbulence, the entrance to the narrowed section had rounded walls. The flume is equipped with a side-mounted Acoustic Doppler Current Profiler (ACDP) to measure water velocities and determine flow rates.

Water quality in the flume was maintained with a canister filtration system that screens pumped flow with multiple 10-micron mesh bag filters. An ultraviolet sterilizer was also operated on the filtration loop to reduce the presence of

pathogens. A 100-ton chiller was available, if needed, during warm weather months to maintain water temperatures at specified levels for any given species.

During survival testing, treatment fish were released into the flume through a vertical 20.3-cm (8-inch) diameter release tube with an exit located 12.7 cm (5 inches) upstream of the turbine duct and 40.6 cm (16 inches) above the centerline of the unit at the hub. The upstream side of the turbine duct and the release tube exit were enclosed within a 2.2-cm (0.875-inch) knotless mesh net that was designed to prevent escape and only allow downstream passage of treatment fish through the turbine (Figure 2-5). Control groups were released into the flume during survival trials through an introduction system similar to the one used for treatment fish, but with the exit located downstream and to the side of the turbine (Figure 2-5). For behavioral tests, the net enclosure was removed and the treatment release tube was moved 1.45 m (4.75 ft) upstream of the turbine to allow fish the opportunity to avoid entrainment through the blades (Figure 2-6).

Underwater cameras used to record video during survival and behavioral trials were located upstream of and on either side of the turbine, and on the flume floor downstream of the turbine. For survival testing, an additional camera was mounted inside the net enclosure at the upstream end with a partial view of the turbine blade rotational area. A DIDSON acoustic camera was used for light and dark test conditions evaluated during behavioral trials at a velocity of about 1.05 m/s (3.5 ft/s). The DIDSON was located about 6.9 m (22.5 ft) upstream of the turbine at a depth of about 0.45 m (1.5 ft). The use of the DIDSON during daytime trials was to provide a correction factor for nighttime entrainment counts recorded from DIDSON images by comparing the underwater video entrainment counts to DIDSON counts from the daytime trials (see the Behavioral Analysis sub-section below for a more detailed description of the calculations used to adjust the nighttime DIDSON turbine entrainment counts).

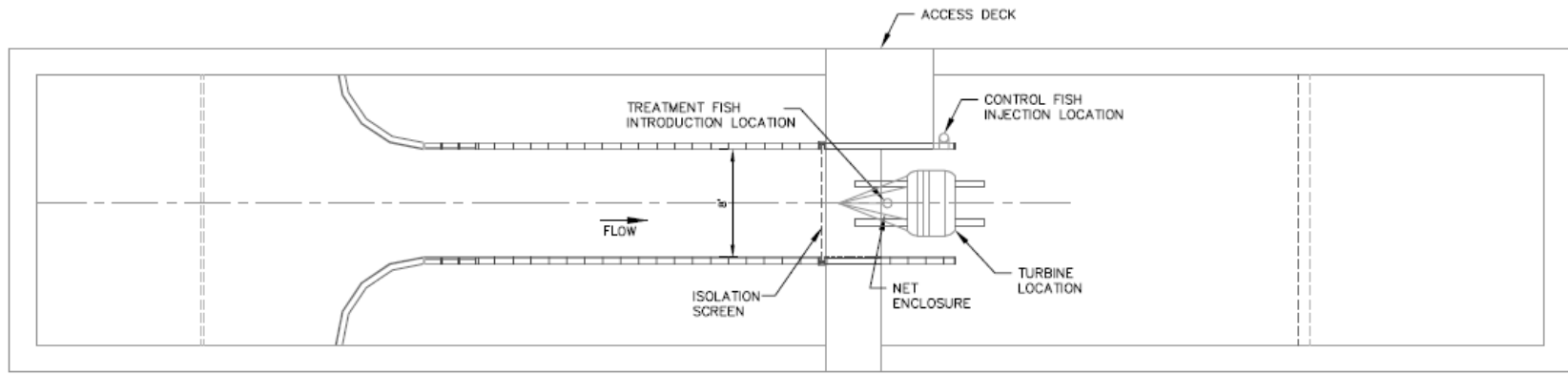

PLAN

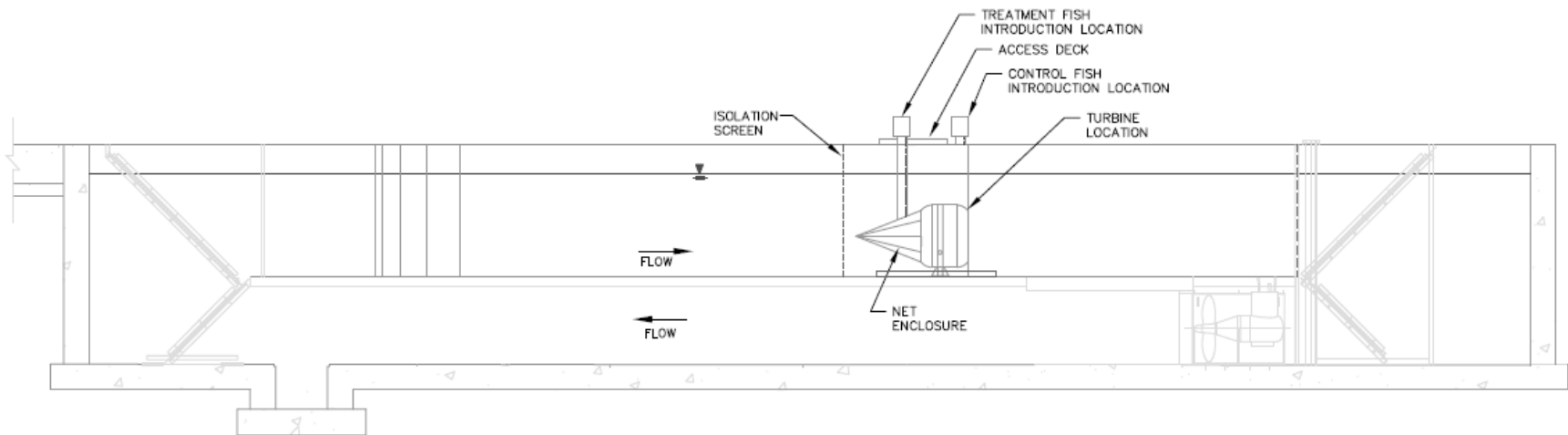

ELEVATION

Figure 2-3
Alden's large flume fish testing facility configured for the biological evaluation of the FFP hydrokinetic turbine.



Figure 2-4
View downstream (A) and upstream (B) of the narrowed flume channel used for fish testing with hydrokinetic turbines.

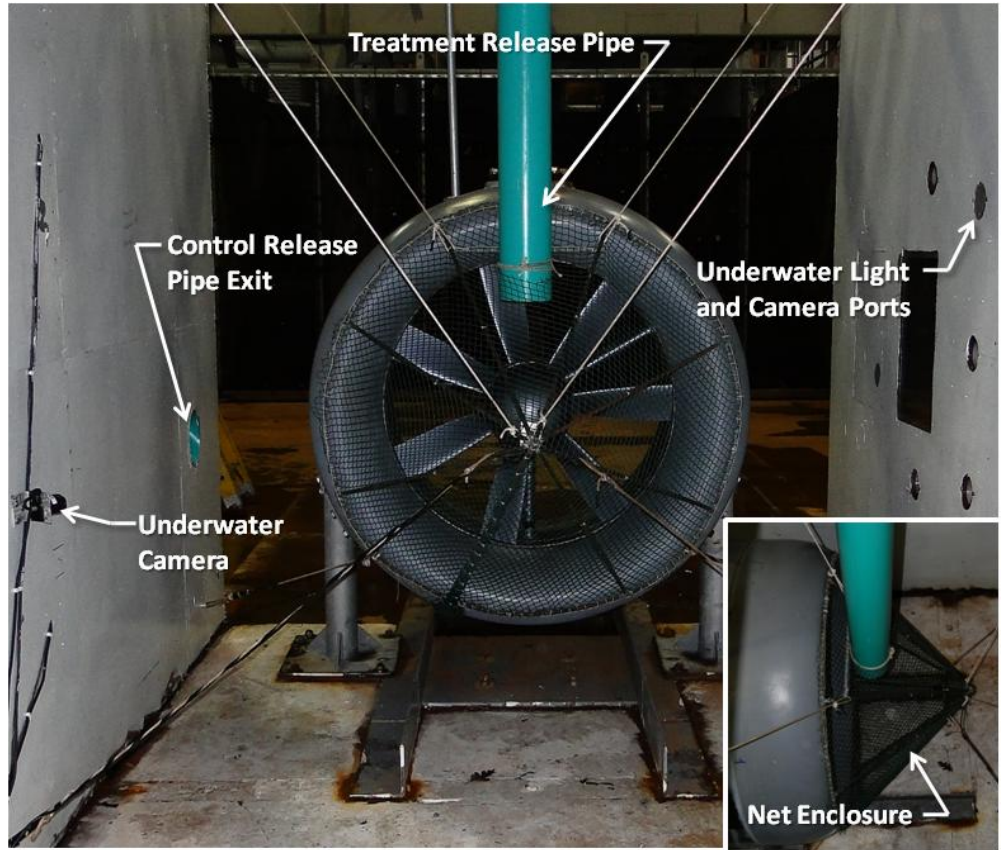

Figure 2-5
Upstream side of the FFP turbine with fish release, enclosure net, and underwater camera locations used for turbine passage survival trials. Insert is view from above.



Figure 2-6

Rainbow trout moving downstream on the upstream side of the FFP turbine during a behavioral trial. For these tests, the enclosure net was removed and the treatment fish release tube was moved to a position 1.45 m upstream from the turbine duct with the tube exit at the same depth as that used for survival tests.

Test Species and Fish Holding Facility Design and Operation

Three fish species, rainbow trout, white sturgeon, and hybrid striped bass, were selected for testing to provide a variety of species that are likely to encounter hydrokinetic turbines in riverine environments. Rainbow trout were tested with the two turbine designs evaluated in 2010, primarily because they are readily available from commercial sources in a variety of sizes throughout the year and are considered representative of other salmonids (trout and salmon) and, with respect to blade strike injury and survival, many other teleost species (i.e., boney fishes common to riverine and estuarine environments). White sturgeon are also commercially available and are considered representative of other sturgeon species that occur throughout North America (e.g., green, lake, shovelnose, pallid, shortnose, and Atlantic sturgeons), including species that occur at several sites where hydrokinetic turbines have been or will be deployed. Also, evidence from blade strike and turbine passage studies indicates sturgeon may be less susceptible to injury from blade strike than teleost species (e.g., trout and salmon, basses and sunfish, carps and minnows, suckers). There also may be behavioral differences that affect how sturgeon react to hydrokinetic turbines compared to trout and other common teleost fishes. Hybrid striped bass were selected since they were also readily available and are considered representative of other bass species. Bass have a different body shape than trout and sturgeon and are typically considered to be weaker swimmers at higher velocities.

Rainbow trout were acquired from Hy-On-A-Hill Trout Farm located in Plainsfield, New Hampshire, white sturgeon were acquired from Professional Aquaculture Services Farm located in Chico, California, and hybrid striped bass were acquired from Osage Catfisheries Inc. located in Osage Beach, Missouri. All sources are certified disease-free facilities, ensuring that test fish were of high quality and in good health. Target size classes selected for testing included length ranges of about 100 to 150 mm (4 to 6 inches) for the sturgeon, bass and small trout and 225 to 275 mm (9 to 11 inches) for the larger trout. These sizes were selected as representative of life stages that may be susceptible to entrainment through hydrokinetic turbines. The use of two size groups for trout provides for an analysis of size effects on entrainment rates and strike injury and mortality. Fish smaller than those tested may also be entrained, but would be expected to have lower strike probability and mortality. Larger fish should have a greater ability to avoid entrainment due to stronger swimming capabilities.

All fish were held prior to testing and during 48-hr post test observation periods in a re-circulating aquaculture facility located in a building adjacent to the test flume. The aquaculture facility has seven 1590-L (420-gal) circular tanks (1.5 m [5 ft] in diameter, 0.91 m [3 ft] deep) and eighteen 890-L (235-gal) circular tanks (1.22 m [4 ft] in diameter, 0.76 m [2.5 ft] deep; Figure 2-7). Each holding tank is supplied with a continuous flow of 15 to 26.5 lpm (4 to 7 gpm) and ambient air pumped through air stones by a 1-hp blower. Water from the holding tanks drained into two 5678-L (1,500-gal) sumps through a series of coarse mesh bag filters to remove any heavy solids and waste products. A 10-hp pump transferred the water through the life support system. This system consisted of bead filters followed by a series of bag filtration units equipped with 25 micron filter bags to remove the remaining fine particulates. The filtered water then passed through two 400-watt ultraviolet sterilization units to reduce the presence of pathogens, followed by activated carbon filtration units to remove other impurities. Water then passed through bio-filtration tanks containing plastic filtration media colonized with bacteria to remove toxic nitrogenous waste. A chiller unit and submersible heaters are used to maintain optimum temperatures for the species and life stages being held. The facility is equipped with an alarm unit with an auto-dialer which is operational 24/7 to notify Alden staff in the event of a facility malfunction (e.g., pump failure, power outage, low water levels).

During daily fish husbandry and facility operations temperature, dissolved oxygen, salinity and pH are monitored, and ammonia was measured at least once per week. Water quality adjustments and filter maintenance was conducted as needed throughout the day and all make-up water (from a municipal source) was first held within a 9463.5-L (2,500-gal) pre-treatment tank to remove chlorine prior to addition to the facility. Fish were fed commercially available pelletized feed twice daily and were examined externally on a daily basis for disease, fungus, or signs of parasites.



Figure 2-7
Re-circulating aquaculture facility.

Experimental Design and Test Procedures

The biological evaluation of the FFP turbine included two test types, one designed to estimate turbine passage survival and the other to assess behavioral interactions as fish moved downstream and encountered the turbine. Survival testing involved releasing fish into a containment net enclosing the upstream area leading to the turbine in attempts to force fish to pass through the rotating blades when moving downstream, whereas behavioral trials focused on whether fish would actively avoid passing through the turbine when released farther upstream. The study design for survival testing included three species, two size groups (trout only), and two approach velocities with corresponding turbine rotational speeds (Table 2-1). The study design for behavioral testing included the same species and size groups used in survival tests, as well as two lighting conditions (day and night) and three approach velocities with corresponding turbine rotational speeds (Table 2-1). A third approach velocity was added to the behavioral evaluation after it was demonstrated that the DIDSON acoustic camera could not provide images of fish at the higher velocities due to excessive air entrainment in the flume that interfered with the acoustic signal and prevented fish being seen at the higher velocities (1.5 and 2.0 m/s [5 and 6.5 ft/s]). Consequently, the nighttime lighting condition at the two higher velocities was dropped from behavioral testing and replicates at 1.1 m/s (3.5 ft/s) approach velocity under day and nighttime lighting conditions were added (Table 2-1).

Table 2-1

Test conditions evaluated with the FFP turbine. Test species included rainbow trout (RBT) white sturgeon (WST) and hybrid striped bass (HSB).

| Species | Size Group (mm) | Test Type | Velocity (m/s) | Lighting Condition | Replicate Trials | Total Treatment Fish | Total Control Fish |
|---------|-----------------|------------|----------------|--------------------|------------------|----------------------|--------------------|
| RBT | 125 | Survival | 1.5 | day | 5 | 500 | 500 |
| | | | 2.0 | day | 5 | 500 | 500 |
| | | Behavioral | 1.1 | day/night | 3 | 150 | - |
| | | | 1.5 | day | 3 | 150 | - |
| | | | 2.0 | day | 3 | 150 | - |
| | 250 | Survival | 1.5 | day | 5 | 500 | 500 |
| | | | 2.0 | day | 5 | 500 | 500 |
| | | Behavioral | 1.0 | day/night | 3 | 300 | - |
| | | | 1.5 | day | 3 | 300 | - |
| | | | 2.0 | day | 3 | 300 | - |
| WST | 125 | Survival | 1.5 | day | 3 | 75 | 75 |
| | | | 2.0 | day | 3 | 75 | 75 |
| | | Behavioral | 1.1 | day/night | 3 | 75 | - |
| | | | 1.5 | day | 3 | 75 | - |
| | | | 2.0 | day | 3 | 75 | - |
| HSB | 125 | Survival | 1.5 | day | 3 | 150 | 150 |
| | | | 2.0 | day | 3 | 150 | 150 |
| | | Behavioral | 1.1 | day/night | 3 | 150 | - |
| | | | 1.5 | day | 3 | 150 | - |
| | | | 2.0 | day | 3 | 150 | - |

Survival Testing

Survival tests were conducted to estimate blade strike injury and mortality (i.e., turbine passage survival) associated with fish entrainment through the turbine (assuming little or no damage to fish would occur due to other injury mechanisms, such as hydraulic shear or pressure changes). To estimate survival, groups of marked fish were released immediately upstream (treatment) and downstream (control) of the test turbine while it was operating at the selected approach flow velocities and rotational speeds. Treatment and control groups were handled and released in the same manner, with the only difference being release location and the subsequent exposure of treatment fish to the operating turbine. The use of controls allowed for injury and mortality associated with handling and test procedures (e.g., marking, release, collection) to be determined and distinguished from that of passage through the turbine.

Sample size requirements for rainbow trout and white sturgeon were developed using methods described by Mathur et al. (1996a) for release-recapture turbine survival studies conducted with tagged fish. The goal for tests with rainbow trout was to estimate turbine passage survival with a precision level of ± 0.02 (or less) for a 95% confidence interval ($\alpha = 0.05$). Sample size calculations assumed a treatment (turbine passage) survival rate of 0.990, control survival of 0.995, and recapture rates of 0.990. These parameter estimates are derived from tests conducted with rainbow trout and two hydrokinetic turbine designs in 2010 (EPRI 2011), but were adjusted slightly to account for modifications to testing procedures incorporated into the current study that were expected to lead to improved recapture rates for smaller fish and higher and less variable control survival. A sample size of 382 trout (i.e., treatment = control = 382; combined total = 764) was determined to be required to meet the specified level of precision. As a conservative measure, samples size for rainbow trout was increased to 1,000 fish, which was divided among five replicate trials (100 treatment and 100 control fish per trial) for each set of test conditions evaluated (size class, approach velocity, and light condition).

Due to the relatively high cost associated with purchasing white sturgeon from a commercial supplier, the desired level of precision for survival estimates with this species was set lower than it was for trout. The target precision level for sturgeon survival estimates was ± 0.05 for a 95% confidence interval ($\alpha = 0.05$). Using the same survival and recapture rate parameter estimates as those used for trout, the sample size estimate for white sturgeon at the specified level of precision was 61 fish (treatment = control = 61; combined total = 122). Based on this estimate and to provide for potentially greater precision, each set of test conditions evaluated with sturgeon included three replicate trials with 25 treatment and 25 control fish per trial (i.e., a total of 150 fish).

Hybrid striped bass were not initially included in the study plan for testing with the FFP turbine, but were made available after the completion of a fish screening study conducted at Alden shortly before hydrokinetic testing was scheduled to begin. The bass used in the FFP turbine testing were surplus fish that were not tested during the screening study. The level of replication and sample size for

tests with this species were based on the number of fish available, not statistical power and sample size calculations. Hybrid bass tests included three trials with 50 treatment and control fish per trial (combined total of 450 fish). Also, in order to test hybrid bass within the approved scope of work for the study with minimal additional effort, they were evaluated at the same time as the sturgeon (i.e., bass and sturgeon were released and collected together for each replicate trial).

All treatment and control fish were marked with biologically inert, encapsulated photonic dyes 24 hours or more prior to testing using a New West POW'R-Ject marking gun. This marking system uses compressed CO₂ to inject the photonic dye at the base of or into individual fins. Four dye colors and four fin locations were used to provide 16 unique marks. Uniquely marked release groups allowed treatment and control fish to be released and recovered simultaneously, and for fish recovered after the test of their release to be identified (during the 2013 study, only one individual was recovered at the end of a later trial). Also, of the 4,899 treatment and control fish recovered during survival testing, only 61 (1.3%) did not have a discernible mark when recovered. Following marking, each treatment and control group was placed into separate holding tanks where they remained until testing (fish typically were marked the day prior to testing).

For each trial, treatment and control groups were placed into separate mobile transport tanks and moved to the test flume area after being re-counted and checked for the correct fin mark. During the re-count and mark check, any fish with visible injuries or swimming abnormally were removed. Each group was released into the flume after the flume channel velocity and turbine rotational speed were set and stabilized. Treatment fish were transferred from the mobile tank into the fish injection system from which they entered the flume immediately upstream of the operating turbines (and within the containment net enclosing this area; see Figure 2-5). Control fish were transferred from the mobile tank and released into a separate introduction system with an exit located immediately downstream of and to one side of the turbine (see Figure 2-5).

After introduction, treatment fish movement and passage through the turbine was monitored and recorded with underwater video cameras. Each trial was terminated after all treatment fish had passed the turbine or approximately ten minutes after introduction. Any treatment fish that remained upstream of the turbine (i.e., within the containment net) at the end of a test were enumerated. At the completion of each trial, the flow in the flume was turned off and the water level was lowered to facilitate recovery of all fish. Fish were then crowded with a seine net for recovery, counted, and transferred to the holding facility where live fish were held for the 48-hr delayed mortality assessment. Live treatment and control fish from a given trial remained together in the same post-test holding tank from the time of collection until the end of the delayed mortality holding period. The time required to conduct a single trial was about two to three hours, which allowed for up to three survival trials to be completed on each day of testing.

Survival, injury, and scale loss evaluations were conducted on all recovered fish to enumerate immediate and delayed mortalities, external injuries, and percent scale

loss. Immediate mortalities were classified as any fish that died within one hour from the completion of a test. This included any fish that were euthanized at the one hour post-test observation due to abnormal swimming behavior (lying on tank bottom) or extensive injuries (large lacerations). Twenty-four hour mortalities were classified as any fish that died between one and 24 hours from the completion of a test. Forty-eight hour mortalities were classified as any fish that died between 24 hours and 48 hours post-test.

Injury and scale loss evaluations were conducted at the end of the 48 hour post-test holding period for live fish and at the time of recovery for immediate and delayed mortalities. External injuries were recorded as bruising/hemorrhaging, lacerations, severed body, fin damage, and eye damage. Using methods similar to those reported by Neitzel et al. (1985) and Basham et al. (1982), percent scale loss (< 3%, 3 – 20%, 20 – 40%, and > 40%) was recorded for each of three locations along the length of the body (Figure 2-8). If greater than 20% scale loss was recorded for two or more locations then a fish was classified as descaled. During the injury evaluation, each fish was also inspected for fin mark location and color to determine release group and test number, and measured for fork length to the nearest millimeter.

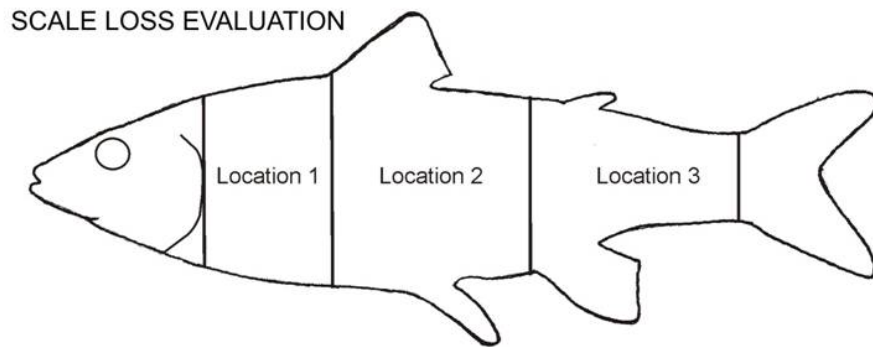

Figure 2-8
Diagram showing the body locations assessed for percent scale loss on all evaluated fish.

Behavioral Testing

For behavioral trials, the containment net was removed from the upstream side of the turbine and the fish introduction system used for treatment fish during survival testing was moved to a distance of about 1.45 m (4.8 ft) upstream from the turbine. Underwater cameras were used to record video from several locations to evaluate fish behavior and passage through and around FFP turbine during the daylight condition trials. During trials with nighttime light conditions, a DIDSON acoustic camera was used to observe fish behavior and passage through and around the turbine unit. However, due to excessive air entrainment that created high levels of acoustic backscatter, fish could not be seen in the DIDSON images at the selected test velocities of 1.5 and 2.0 m/s (5 and 6.5

ft/s). Therefore, nighttime light conditions were only evaluated at a lower velocity (1.1 m/s (3.5 ft/s) at which air entrainment did not interfere with the DIDSON acoustic signal. This velocity was also tested with the daylight condition using both underwater video cameras and the DIDSON to record fish behavior and movement. Having videos from both monitoring devices allowed for the nighttime condition DIDSON recordings to be adjusted based on turbine entrainment count comparisons between underwater video and DIDSON recordings.

For behavioral testing, three replicate trials were conducted for each set of test conditions (species, size group, and approach velocity). Due to fewer fish being available following survival testing than initially expected, the small rainbow trout size groups were reduced to 50 fish per replicate. The larger trout, hybrid bass, and white sturgeon were evaluated using the same numbers of fish per replicate as survival testing (see Table 2-1). Test groups were counted and placed into one of the mobile transport tanks and brought to the test flume. Once the flume channel velocity and turbine rotational speed were established, a group of fish was released. After introduction, fish movement through or around the turbine was monitored and recorded with the underwater video system and/or DIDSON camera, as described previously. After all fish in a given release group had moved downstream of the turbine (typically within 5 minutes of release), the next test species/size group was released. After completion of a trial with each of the species/size groups at a given approach velocity, the isolation screen was lowered immediately to prevent fish from moving up or downstream of the turbine. The flow through the flume was turned off as the screen was dropped into place and the water level was lowered to allow personnel to enter the flume and collect fish. Fish were crowded with a seine net for recovery, then counted and returned to the holding facility. Collected fish were categorized as live or dead and by location of recovery (i.e., downstream or upstream of turbine).

Data Analysis

Turbine Passage Survival

The data analysis for the survival evaluation of the FFP turbine includes assessments of immediate (1 hr) and delayed (48 hr) mortality and injury and scale loss. Sample sizes varied from target numbers for some trials depending on the accuracy of marking counts or the occurrence of mortality or injury between marking and testing. Immediate and total (immediate plus 48-hour) passage survival rates were estimated and statistically analyzed using a maximum likelihood estimation (MLE) model developed for paired release-recapture studies with a single recapture event (Burnham et al. 1987). Turbine survival and

95% confidence intervals were calculated using pooled-replicate data for each set of test conditions following procedures described by Skalski (1999). The input parameters for survival estimates included the following:

N_c = total number of control fish recovered (live and dead);

c = number of control fish recovered live;

N_t = total number of treatment fish recovered (live and dead); and

t = number of treatment fish (i.e., turbine passed) recovered live.

Immediate (1-hr) and total (1-hr + 48-hr) control survival (S_C) and turbine survival (S_T) were calculated as:

$$S_C = \frac{c}{N_c} \quad \text{Eq. 2-1}$$

$$S_T = \frac{tN_c}{N_t c} \quad \text{Eq. 2-2}$$

with a variance for S_T of:

$$\text{Var}(S_T) = S_T^2 \left[\frac{1-S_C S_T}{N_t S_C S_T} + \frac{1-S_C}{N_c S_C} \right] \quad \text{Eq. 2-3}$$

and a 95% confidence interval ($\alpha = 0.05$) of:

$$S_T \pm 1.96\sqrt{\text{Var}(S_T)} \quad \text{Eq. 2-4}$$

Statistical differences in survival rates between treatment conditions (i.e., between size groups within velocity and between velocities within size group) and between treatment and control groups for a given set of test conditions were determined by non-overlapping confidence intervals. Assumptions associated with this model include: (1) all treatment fish have the same probability of survival; (2) all control fish have the same probability of survival; (3) survival probabilities from the point of the control release to recapture are the same for control and treatment fish; and (4) survival from the point of control release to recapture is conditionally independent of turbine survival.

Similar to the previous survival tests conducted with hydrokinetic turbines at Alden, the total number of fish recovered for each release group was used instead of the number released because it was possible for some fish to be recovered during a test conducted after the one in which they were released. However, for the evaluation of the FFP turbine, no treatment fish and only one control fish were collected during a subsequent trial. The control fish was recovered dead and, because the source of lethal injuries or time of death could not be determined for this fish, it was excluded from the survival analysis. Also, some treatment fish remained within the containment net on the upstream side of the turbine. These fish were enumerated and subtracted from the total number of treatment fish recovered from the flume at the end of each trial. Additionally,

marks on a small number of fish could not be located or identified after recovery. The number of fish without identifiable marks at the end of a trial was very low and all of the unmarked recoveries were collected alive. Of the 4,899 treatment and control fish recovered during survival testing, only 61(1.3%) did not have a discernible mark when recovered and all of these fish were alive at the end of the 48-hour post-test holding period. Because fish without identifiable marks could not be assigned to a release group (i.e., treatment or control), they were also excluded from the survival data analysis.

Injury and Descaling Attributed to Turbine Passage

The proportion of treatment fish that was classified as descaled was adjusted with the control data to account for the effects of handling and testing procedures. The adjusted proportion descaled was calculated by dividing the proportion of treatment fish not descaled by the proportion of control fish not descaled, then subtracting the resulting quotient from one. Similar to the survival analysis, the replicate data were pooled for each set of test conditions when calculating the adjusted proportion of fish descaled. The proportion of treatment fish classified as uninjured and injured was adjusted with the control fish data in the same manner.

Behavioral Analysis

The analysis of data collected from behavioral trials focused on qualitative observations of fish behavior as they moved downstream past the turbine and quantitative estimates of entrainment and avoidance rates. Video from the underwater cameras and/or the DIDSON acoustic camera were used to count the number of fish that were entrained through the FFP turbine during each behavioral trial conducted with the three fish species. Videos from the camera covering the downstream side of the FFP turbine were determined to be the most reliable for accurately counting entrained fish as they exited the turbine duct. Entrainment estimates were subtracted from the total number of fish collected downstream of the turbine at the end of a test to determine the number of fish that avoided entrainment during each trial. Fish collected upstream of the turbine after the isolation screen was lowered were excluded from the entrainment analysis. Turbine entrainment rates (E) were calculated as follows:

$$E = \frac{N_E}{N_D} \qquad \text{Eq. 2-5}$$

where N_E is the number of fish entrained (i.e., counted exiting the turbine) and N_D is the total number of fish collected downstream (entrained and non-entrained fish combined).

Because it was difficult to determine from the DIDSON recordings if fish passing close to the FFP turbine were entrained, counts from underwater camera and DIDSON videos recorded during daytime trials at an approach velocity of 1.1 m/s were compared to develop a method to adjust nighttime DIDSON counts. The ratio, R , of underwater camera entrainment counts to DIDSON entrainment counts (average of independent counts by two biologists) was

calculated for the pooled trial data from daytime tests at 1.1 m/s with each species (and by size group for trout) using the following equation:

$$R = \frac{\sum_{i=3}^n U}{\sum_{i=3}^n D} \quad \text{Eq. 2-6}$$

where U is the entrainment count generated from videos recorded with the underwater camera located on the downstream side of the turbine and D is the entrainment count from the DIDSON camera recordings on the upstream side of the turbine. The resulting ratios were then multiplied by the corresponding pooled-replicate DIDSON counts from nighttime tests at 1.1 m/s to provide a more accurate representation of nighttime entrainment rates for each species (and the two size groups of trout).

Estimation of Total Passage Survival

Using turbine survival and avoidance rates estimated with the procedures described above, total passage survival (S_p) for all fish passing downstream of the FFP turbine was calculated with the following equation for each species and the two approach velocities evaluated during the survival evaluation:

$$S_p = A + (E \times S_T) \quad \text{Eq. 2-7}$$

where A is the proportion of fish that avoid turbine entrainment, E is the proportion of fish entrained through the turbine and S_T is turbine survival, as described previously. Survival of fish that avoid turbine entrainment was assumed to be 100%. This provides an overall measure of survival for all fish that encounter a turbine and either pass downstream around or through it. The lower and upper limits of the 95% confidence intervals for turbine survival and avoidance estimates were used to calculate ranges of total passage survival for each species and test velocity as follows:

$$\text{Range } S_p = A_{\pm 95\%CI} + (E_{\pm 95\%CI} \times S_T) \quad \text{Eq. 2-8}$$

where $A_{\pm 95\%CI}$ is the lower or upper 95% confidence limit for the avoidance estimate and $E_{\pm 95\%CI}$ is the lower or upper confidence limit for the entrainment estimate.

Velocity Measurements

Velocity measurements were recorded to verify that the flume operating conditions produced the desired approach velocities with a relatively uniform distribution upstream of the test turbine. Velocity measurements were used to develop a predicted bow thruster output curve, such that bow thruster rpm could be used to set the approach velocity for each test. Once the appropriate rpm for each velocity condition was determined, a complete velocity profile was measured for each velocity condition and turbine type. Velocities in the flume were measured for each test type (survival and behavioral) and velocity condition in a 3 by 3 grid to determine the average velocity profile for a given condition across the flume channel (Figure 2-9). Velocity measurements were recorded using a

Swoffer propeller-style velocity meter. Velocity profile measurements were recorded 6.9 m (22.5 ft) upstream of the turbine for both test types (Table 2-2). An additional velocity profile was recorded 0.46 m (1.5 ft) in front of the turbine for the behavioral velocity conditions. Velocity measurements recorded during the survival conditions were completed with the net enclosure in place. Additionally velocity measurements were recorded 0.33 m (1.1 ft) upstream of the turbine hub (center hub) and at a location half way between the hub and the turbine shroud (off center) approximately 0.66 m (22 ft) upstream of the blades for each velocity condition. These velocity measurements were recorded in front of the turbine within the net enclosure to document the approach velocities experienced by the treatment fish during survival trials (Table 2-2).

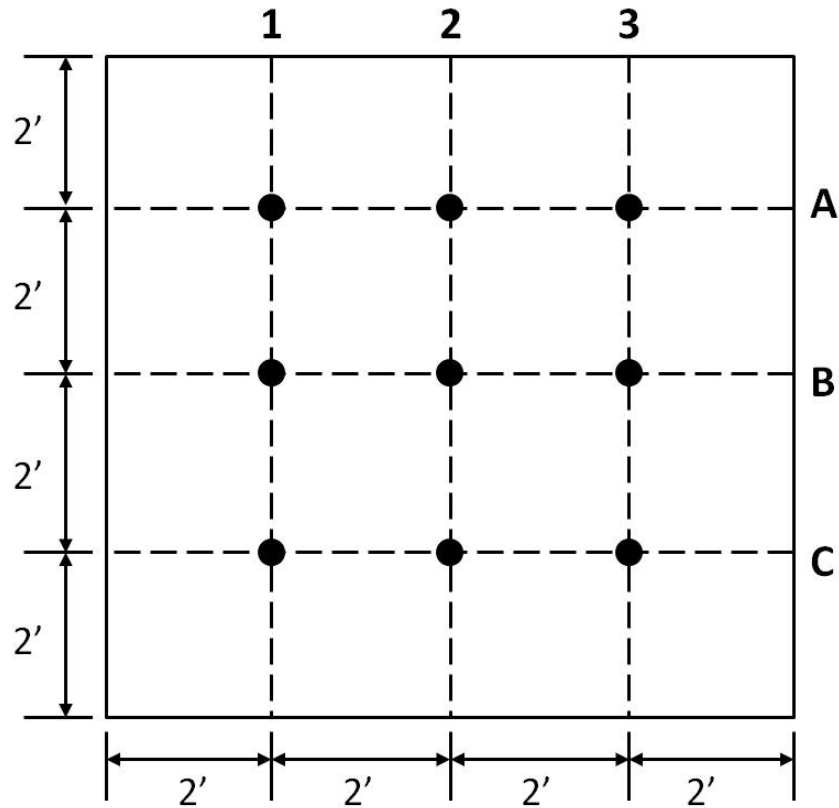



Figure 2-9
Velocity profile 3x3 grid showing locations of approach velocity measurements in the test flume channel.

Table 2-2

Average velocities measured at each channel and grid location at each test and velocity condition tested. Grid locations refer to those presented in Figure 2-9

| Test Type | Channel Location | Grid Location | Measured Velocities (m/s) for Each Target Approach Velocity | | |
|------------|------------------|---------------|---|---------|---------|
| | | | 1.1 m/s | 1.5 m/s | 2.0 m/s |
| Survival | Upstream | 1A | - | 1.43 | 1.83 |
| | | 2A | - | 1.47 | 1.86 |
| | | 3A | - | 1.46 | 1.90 |
| | | 1B | - | 1.54 | 2.01 |
| | | 2B | - | 1.53 | 1.99 |
| | | 3B | - | 1.53 | 1.96 |
| | | 1C | - | 1.53 | 1.97 |
| | | 2C | - | 1.51 | 1.97 |
| | | 3C | - | 1.53 | 1.88 |
| | Turbine | Center Hub | - | 0.73 | 1.03 |
| | Off Center | - | 0.96 | 1.31 | |
| Behavioral | Upstream | 1A | 1.02 | 1.43 | 1.84 |
| | | 2A | 1.05 | 1.43 | 1.88 |
| | | 3A | 1.04 | 1.48 | 1.84 |
| | | 1B | 1.05 | 1.45 | 2.02 |
| | | 2B | 1.03 | 1.52 | 1.99 |
| | | 3B | 1.04 | 1.52 | 1.96 |
| | | 1C | 1.03 | 1.48 | 1.86 |
| | | 2C | 1.03 | 1.52 | 1.95 |
| | | 3C | 1.05 | 1.52 | 1.93 |
| | Turbine | 1A | 1.12 | 1.58 | 1.94 |
| | | 2A | 1.09 | 1.52 | 1.97 |
| | | 3A | 1.10 | 1.57 | 2.06 |
| | | 1B | 1.06 | 1.49 | 1.87 |
| | | 2B | 0.89 | 1.28 | 1.48 |
| | | 3B | 0.93 | 1.39 | 1.85 |
| | | 1C | 1.03 | 1.47 | 1.98 |
| | | 2C | 0.83 | 1.24 | 1.46 |
| | | 3C | 0.94 | 1.37 | 1.85 |



Section 3: Results

Survival Testing

Rainbow Trout

All fish were recovered and accounted for at the end of each trial with the exception of a single control fish recovered dead in a subsequent trial during testing with the smaller trout at a velocity of 2.0 m/s (6.5 ft/s) (Table 3-1). Recovery rates greater than 100% indicate more fish were recovered for a treatment or control group than was counted at the time of release. This may have occurred due to errors in the release counts or in the identification or recording of mark colors and fin locations during post-test fish evaluations. Fifty-six fish recovered during survival evaluation trials with rainbow trout did not have marks that could be identified during the post-test injury evaluation. Unmarked fish could not be assigned to a release group, but all of these fish were recovered alive and survived the post-test observation period (Table 3-1). One control fish (small size group, 2.1 m/s test velocity) was recovered dead during a later test (i.e., after the one in which it was released) and was excluded from the survival analysis.

The percent of treatment fish that passed through the FFP turbine after release into the containment net ranged from 81.0% at the lower approach velocity to 97.2% at the higher velocity for tests with the smaller trout, and 78.7 to 97.8% for tests with the larger trout. These data demonstrate that trout had less ability to hold position upstream of the turbine at the higher velocity, but avoidance of turbine passage during survival tests was similar between the two size groups.

Table 3-1

Summary of fish release, recovery, and mortality data for rainbow trout tested during the survival evaluation with the FFP turbine. Fish that did not have a discernible mark (NM) when recovered at the end of a trial were excluded from the survival analysis.

| Size Group | Approach Velocity (m/s) | Mean FL and SD (mm) | Number of Trials | Test Group | Total Released | Treatment Fish in Upstream Containment Net at Test End | | Total Recovered Live | Turbine-passed Fish Recovered Live (1 hr) ¹ | Immediate Mortalities (1 hr) ² | Delayed Mortalities (48 hr) ³ |
|------------|-------------------------|---------------------|------------------|------------|----------------|--|------|----------------------|--|---|--|
| | | | | | | Alive | Dead | | | | |
| small | 1.5 | 172 (12.8) | 5 | T | 500 | 86 | 9 | 490 | 404 | 0 | 0 |
| | | | | C | 500 | - | - | 501 | - | 0 | 0 |
| | | | | NM | - | - | - | - | - | - | - |
| | 2.0 | 168 (15.5) | 5 | T | 494 | 9 | 5 | 486 | 477 | 3 | 3 |
| | | | | C | 492 | - | - | 477 | - | 1 | 0 |
| | | | | NM | - | - | - | 13 | - | 0 | 0 |
| large | 1.5 | 271 (21.6) | 5 | T | 502 | 104 | 3 | 496 | 392 | 0 | 0 |
| | | | | C | 509 | - | - | 471 | - | 0 | 0 |
| | | | | NM | - | - | - | 41 | - | 0 | 0 |
| | 2.0 | 246 (16.5) | 5 | T | 501 | 8 | 3 | 486 | 478 | 11 | 1 |
| | | | | C | 502 | - | - | 501 | - | 0 | 0 |
| | | | | NM | - | - | - | 2 | - | 0 | 0 |

¹ Turbine-passed fish and any fish that remained in the containment net upstream of the turbine at the end of a trial could not be differentiated when fish were recovered from the flume. Therefore, the number of turbine-passed fish recovered alive was calculated by subtracting the number of alive treatment fish that were upstream of the turbine in the containment net at the end of a test from the total number recovered alive downstream of the turbine.

² All treatment fish recovered dead downstream of the turbine at the end of a trial were assumed to be turbine-passed fish.

³ All treatment mortalities that occurred during the 48-hour post test holding periods were assumed to be turbine-passed fish.

Immediate and total turbine passage survival rates for rainbow trout were 100% for both size groups at the lower approach velocity and about 98% and greater at the higher velocity (Table 3-2). For the smaller size group, the differences between turbine survival rates estimated for the two test velocities were not statistically significant ($P > 0.05$), whereas the survival of the larger trout was significantly greater at the lower test velocity than at the higher velocity ($P < 0.05$). Survival rates were not significantly different between size groups at each test velocity ($P > 0.05$). Also, differences in immediate and total survival estimated for control and treatment groups were statistically significant only for the larger fish tested at a velocity of 2.0 m/s ($P < 0.05$).

The total percent of treatment fish recovered with visible external injuries was higher than it was for controls for both size groups and test velocities (Table 3-3). The injury rate of treatment fish also increased for both size groups at the higher velocity. Control injury rates were similar for the small fish at the two test velocities, but were greater at the lower velocity for the large fish. Bruising was the most prevalent injury type observed for each test group, size group, and velocity evaluated (Table 3-3). The percent of treatment and control fish with other injury types (eye damage and lacerations) was less than 1.5%.

The percent of fish classified as descaled (live and dead recoveries combined) was similar for treatment and control groups for tests with the smaller trout and higher for treatment fish for tests with the larger trout (Table 3-4). When adjusted for control data, the percent of turbine-passed fish classified as descaled (live and dead recoveries combined) was 0.0% at the lower test velocity and 0.1% at the higher velocity for the smaller fish. Adjusted descaling rates for the large size group were higher and increased with velocity (9.5% at 1.5 m/s and 22.3% at 2.0 m/s). Descaling was more prevalent for the larger trout that were recovered dead following turbine passage compared to live recoveries.

Table 3-2

Turbine Passage survival estimates for rainbow trout evaluated with the FFP turbine. For comparisons with in each type of estimate (immediate and total), turbine survival estimates without a letter in common are significantly different ($P < 0.05$).

| Size Group | Mean Fork Length (mm) | Approach Velocity (m/s) | Immediate Survival (1 hr) (%) ± 95% CI | Total Survival (1 hr + 48 hr) (%) ± 95% CI |
|-------------------|------------------------------|--------------------------------|---|---|
| small | 172 | 1.5 | 100.0 ± 0.0 ^a | 100.0 ± 0.0a |
| | 168 | 2.0 | 99.6 ± 0.8 ^{ab} | 98.7 ± 1.1b |
| large | 271 | 1.5 | 100.0 ± 0.0 ^a | 100.0 ± 0.0a |
| | 246 | 2.0 | 97.8 ± 1.3 ^b | 97.5 ± 1.4b |

Table 3-3

Percent of rainbow trout observed with external injuries during survival testing. The number of treatment fish assessed includes both turbine-passed fish and any fish that remained in the containment net upstream of the turbine at the end of a trial because they could not be differentiated when fish were recovered from the flume. The sum of the percents for each injury type may be higher than the total percent injured because some fish suffered multiple injuries.

| Size Group | Approach Velocity (m/s) | Alive/Dead | Total Number Assessed | | Injured (%) | | Bruising (%) | | Eye Injury (%) | | Laceration (%) | |
|------------|-------------------------|------------|-----------------------|-----|-------------|-------|--------------|-----|----------------|-------|----------------|-----|
| | | | T | C | T | C | T | C | T | C | T | C |
| small | 1.5 | alive | 490 | 501 | 9.6 | 1.2 | 9.0 | 1.2 | 0.6 | 0.0 | 0.0 | 0.0 |
| | | dead | 0 | 0 | - | - | - | - | - | - | - | - |
| | | total | 490 | 501 | 9.6 | 1.2 | 9.0 | 1.2 | 0.6 | 0.0 | 0.0 | 0.0 |
| | 2.0 | alive | 483 | 476 | 17.4 | 6.1 | 17.2 | 6.1 | 0.4 | 0.0 | 0.0 | 0.0 |
| | | dead | 6 | 1 | 83.3 | 100.0 | 66.7 | 0.0 | 16.7 | 100.0 | 16.7 | 0.0 |
| | | total | 489 | 477 | 18.2 | 6.3 | 17.8 | 6.1 | 0.6 | 0.2 | 0.2 | 0.0 |
| large | 1.5 | alive | 496 | 471 | 14.5 | 4.7 | 13.5 | 3.0 | 0.8 | 1.3 | 0.4 | 0.4 |
| | | dead | 0 | 0 | - | - | - | - | - | - | - | - |
| | | total | 496 | 471 | 14.5 | 4.7 | 13.5 | 3.0 | 0.8 | 1.3 | 0.4 | 0.4 |
| | 2.0 | alive | 485 | 501 | 21.0 | 3.8 | 21.0 | 3.8 | 0.2 | 0.2 | 0.0 | 0.0 |
| | | dead | 12 | 0 | 75.0 | - | 66.7 | - | 25.0 | - | 0.0 | - |
| | | total | 497 | 501 | 22.3 | 3.8 | 22.1 | 3.8 | 0.8 | 0.2 | 0.0 | 0.0 |

Table 3-4

Percent of rainbow trout classified as descaled during survival tests. The number of treatment fish assessed includes both turbine-passed fish and fish that remained in the containment net upstream of the turbine until at the end of each trial, which could not be differentiated when fish were recovered from the flume.

| Size Group | Approach Velocity (m/s) | Alive/Dead | Treatment | | Control | | % Treatment Descaled Adjusted for Control Data |
|------------|-------------------------|------------|-----------------|--------------------------|-----------------|--------------------------|--|
| | | | Number Assessed | % Classified as Descaled | Number Assessed | % Classified as Descaled | |
| small | 1.5 | alive | 490 | 28.4 | 501 | 30.1 | 0.0 |
| | | dead | 0 | - | 0 | - | - |
| | | total | 490 | 28.4 | 501 | 30.1 | 0.0 |
| | 2.0 | alive | 483 | 27.7 | 476 | 27.4 | 0.5 |
| | | dead | 6 | 16.7 | 1 | 100.0 | 0.0 |
| | | total | 489 | 27.6 | 477 | 27.5 | 0.1 |
| large | 1.5 | alive | 496 | 26.6 | 471 | 18.9 | 9.5 |
| | | dead | 0 | - | 0 | - | - |
| | | total | 496 | 26.6 | 471 | 18.9 | 9.5 |
| | 2.0 | alive | 485 | 26.8 | 501 | 7.8 | 20.6 |
| | | dead | 12 | 91.7 | 0 | - | 91.7 |
| | | total | 497 | 28.4 | 501 | 7.8 | 22.3 |

Hybrid Striped Bass

Only one treatment fish remained in the containment net and did not pass through the turbine during hybrid bass trials conducted at the 1.5 m/s approach velocity; all treatment fish passed through the turbine at the higher velocity (Table 3-5). Four treatment fish were not recovered at the completion of the trial in which they were released or in a subsequent trial during testing at 2.0 m/s. Depending on their size, these fish may have avoided recovery after passing through the mesh of the downstream isolation screen. The marks on all treatment and control fish were identifiable during the post-test injury evaluation (i.e., there were no hybrid bass classified as “no mark”).

Immediate and total turbine passage survival rates for hybrid striped bass were 98.0 and 91.1%, respectively, at the lower approach velocity (Table 3-6), and exceeded 100% at the higher velocity due to control mortality being greater than treatment fish mortality. The differences between immediate and total survival rates estimated for both velocities were statistically insignificant ($P > 0.05$). The relatively low total survival rate (91.1%) estimated for bass tested at the 1.5 m/s test velocity was primarily due to a large number of treatment fish delayed mortalities that occurred during one of the three trials. This high level of mortality during the post test holding period appears to be an outlier, particularly since turbine survival was essentially 100% at the higher approach velocity. The cause for the high delayed mortality of treatment fish at the lower velocity is unknown, but it may have been related to an isolated aberration in testing protocols or procedures that resulted in elevated stress and/or increased injury experienced by fish in this group. In particular, some aspect of fish handling or release into the containment net may have resulted in increased impingement on the net before fish passed through the turbine or on the downstream isolation screen after turbine passage. When data from the trial for which high delayed mortality occurred are excluded from the analysis, total turbine survival of hybrid bass at 1.5 ft/s is 96.0% with a 95% CI of 3.9%. Immediate survival rates of control and treatment groups were not significantly different ($P > 0.05$) for bass tested at each velocity. Total survival differed significantly between the two test groups at the lower approach velocity only ($P < 0.05$). This difference in total survival was also statistically significant when data from the trial with high delayed mortality were removed from the analysis.

The percent of treatment fish recovered live with visible external injuries was similar between the two test velocities (Table 3-7). The total injury rate (alive and dead fish combined) for treatment fish was higher at the low velocity and was reflective of the large number of mortalities that occurred during one trial. Nearly all of these dead fish sustained bruising and some experienced lacerations. As stated above, the high incidence of these injuries may have resulted from impingement on the containment net before turbine passage or on the downstream isolation screen after passage. Although this higher injury rate may be attributable to impingement at either of the two locations identified, it is unknown what factors would have potentially contributed to excessive impingement during the one trial in which these injuries were observed. Injury rates for control fish were less than for treatment fish at the lower velocity, but greater at the higher velocity (Table 3-7). Bruising was the most prevalent injury type in treatment and control fish, with very few incidences of eye damage or lacerations.

Table 3-5

Summary of fish release, recovery, and mortality data for hybrid striped bass tested during the survival evaluation with the FFP turbine.

| Approach Velocity (m/s) | Mean FL and SD (MM) | Number of Trials | Test Group | Total Released | Treatment Fish in Upstream Containment Net at Test end | Total Recovered Live | Turbine-passed Fish Recovered Live (1-hr) ¹ | Immediate Mortalities (1 hr) ² | Delayed Mortality (48-hr) ³ |
|-------------------------|---------------------|------------------|------------|----------------|--|----------------------|--|---|--|
| 1.5 | 131 (30.1) | 3 | T | 149 | 1 | 146 | 145 | 3 | 12 |
| | | | C | 148 | - | 148 | - | 0 | 2 |
| 2.0 | 118 (25.7) | 3 | T | 150 | 0 | 146 | 146 | 0 | 6 |
| | | | C | 152 | - | 151 | - | 1 | 6 |

¹ Turbine-passed fish and any fish that remained in the containment net upstream of the turbine until at the end of a trial could not be differentiated when fish were recovered from the flume. Therefore, the number of turbine-passed fish recovered alive was calculated by subtracting the number of treatment fish that remained upstream of the turbine (until the flow and turbine were shut off) from the total number recovered alive downstream of the turbine.

² All treatment fish recovered dead downstream of the turbine at the end of a trial were assumed to be turbine-passed fish.

³ All treatment mortality that occurred during the 48-hour post test holding periods was assumed to be a result of turbine passage.

Table 3-6

Estimates of turbine passage survival (adjusted for control mortality) for hybrid striped bass evaluated with the FFP turbine. Survival rates greater than 100% resulted when control mortality was higher than treatment mortality. Turbine survival estimates were not significantly different ($P > 0.05$) between the two velocities tested.

| Mean Fork Length (mm) | Approach Velocity (m/s) | Immediate Survival (1 hr) (%) \pm 95% CI | Total Survival (1 hr + 48 hr) (%) \pm 95% CI |
|-----------------------|-------------------------|--|--|
| 131 | 1.5 | 98.0 \pm 2.3 | 91.1 ¹ \pm 5.2 |
| 118 | 2.0 | 100.7 \pm 1.3 | 100.5 \pm 4.9 |

¹ The relatively low total survival at this velocity was primarily due to a large number of delayed mortalities experienced by treatment fish during one of the three trials. The cause for this apparent aberration in delayed mortality is unknown. When data from this trial is excluded from the analysis, total survival for the 1.5 m/s velocity is 96% \pm 3.9%.

The percent of hybrid bass classified as descaled increased with velocity for treatment and control fish (Table 3-8) and was higher for controls at both test velocities. Consequently, when adjusted for control data, the percentage of turbine-passed fish classified as descaled was zero for tests at each velocity. These results indicate that observed descaling of hybrid bass that passed through the FFP turbine was the result of handling and testing procedures and not turbine passage.

White Sturgeon

Three of the 75 treatment fish did not pass through the turbine during trials conducted at the lower velocity, whereas all treatment fish passed through the turbine during trials at the higher velocity. All fish were recovered and accounted for at the end of each survival test; however, four fish recovered during testing at 1.5 m/s did not have identifiable marks. Unmarked fish could not be assigned to a release group, but all of these fish were recovered alive and survived the post-test delayed mortality holding period (Table 3-9).

Immediate and total turbine passage survival rates for white sturgeon were 100% for both approach velocities evaluated (Table 3-10). Consequently, there were no statistical differences in survival rates between the two test velocities. Total turbine survival at the lower velocity exceeded 100% due to control mortality being greater than treatment mortality. Immediate and total survival rates of control and treatment groups were not significantly different at either approach velocity ($P > 0.05$).

The percent of treatment and control fish recovered with visible external injuries increased with velocity (Table 3-11). The total injury rate of control fish was lower than it was for treatment fish at the 1.6 m/s test velocity, but was higher at the test velocity of 2.0 m/s (Table 3-11). Bruising was the only primary injury type recorded, with no incidences of eye damage or lacerations.

Table 3-7

Percent of hybrid striped bass observed with external injuries during survival testing (T = treatment, C = control). The number of treatment fish assessed includes both turbine-passed fish and any fish that remained in the containment net upstream of the turbine at the end of a trial because they could not be differentiated when fish were recovered from the flume. For each test group (T and C), the sum of the percents for each injury type may be higher than the total percent injured because some fish suffered multiple injuries.

| Approach Velocity (m/s) | Alive/Dead | Total Number Assessed | | Injured (%) | | Bruising (%) | | Eye Injury (%) | | Laceration (%) | |
|-------------------------|------------|-----------------------|-----|-------------|-------|--------------|-------|----------------|-----|----------------|-----|
| | | T | C | T | C | T | C | T | C | T | C |
| 1.5 | alive | 134 | 146 | 19.4 | 11.0 | 19.4 | 11.0 | 0.0 | 0.0 | 0.0 | 0.0 |
| | dead | 15 | 2 | 86.7 | 100.0 | 86.7 | 100.0 | 0.0 | 0.0 | 6.7 | 0.0 |
| | total | 149 | 148 | 26.2 | 12.2 | 26.2 | 12.2 | 0.0 | 0.0 | 0.7 | 0.0 |
| 2.0 | alive | 140 | 145 | 16.4 | 31.7 | 16.4 | 31.7 | 0.0 | 0.7 | 0.0 | 0.0 |
| | dead | 6 | 7 | 100.0 | 57.1 | 100.0 | 57.1 | 0.0 | 0.0 | 0.0 | 0.0 |
| | total | 146 | 152 | 19.9 | 32.9 | 19.9 | 32.9 | 0.0 | 0.7 | 0.0 | 0.0 |

Table 3-8

Percent of hybrid striped bass classified as descaled during survival tests.

| Approach Velocity (m/s) | Alive/Dead | Treatment | | Control | | % Treatment Descaled Adjusted for Control |
|-------------------------|------------|------------------|--------------------------|------------------|--------------------------|---|
| | | Number Recovered | % Classified as Descaled | Number Recovered | % Classified as Descaled | |
| 1.5 | alive | 134 | 16.4 | 146 | 17.1 | 0.0 |
| | dead | 15 | 0.0 | 2 | 0.0 | 0.0 |
| | total | 149 | 14.8 | 148 | 16.9 | 0.0 |
| 2.0 | alive | 140 | 29.3 | 145 | 35.9 | 0.0 |
| | dead | 6 | 0.0 | 7 | 0.0 | 0.0 |
| | total | 146 | 28.1 | 152 | 34.2 | 0.0 |

Table 3-9

Summary of fish released, turbine passed, recovered, and mortality data for white sturgeon tested during the survival evaluation (T = treatment, C = Control, NM= no identifiable mark).

| Approach Velocity (m/s) | Mean FL and SD (MM) | Number of Trials | Test Group | Total Released | Treatment Fish in Upstream Containment Net at Test End | Total Recovered Live | Turbine-passed Fish Recovered Live (1-hr) ¹ | Immediate Mortalities (1 hr) ² | Delayed Mortality (48-hr) ³ |
|-------------------------|---------------------|------------------|------------|----------------|--|----------------------|--|---|--|
| 1.5 | 123 (14.7) | 3 | T | 75 | 3 | 72 | 69 | 0 | 1 |
| | | | C | 75 | - | 74 | - | 0 | 2 |
| | | | NM | - | - | 4 | - | 0 | 0 |
| 2.0 | 126 (14.6) | 3 | T | 74 | 0 | 74 | 74 | 0 | 0 |
| | | | C | 76 | - | 76 | - | 0 | 0 |
| | | | NM | - | - | 0 | - | 0 | 0 |

¹ Turbine-passed fish and any fish that remained in the containment net upstream of the turbine until at the end of a trial could not be differentiated when fish were recovered from the flume. Therefore, the number of turbine-passed fish recovered live was calculated by subtracting the number of treatment fish that remained upstream of the turbine (until the flow and turbine were shut off) from the total number recovered live downstream of the turbine.

² All treatment fish recovered dead downstream of the turbine at the end of a trial were assumed to be turbine-passed fish.

³ All treatment mortality that occurred during the 48-hour post test holding periods was assumed to be a result of turbine passage.

Table 3-10

Estimates of turbine passage survival (adjusted for control mortality) for white sturgeon evaluated with the FFP turbine. Survival rates greater than 100% resulted when control mortality was higher than treatment mortality. Turbine survival estimates were not significantly different ($P > 0.05$) between the two velocities tested.

| Mean Fork Length (mm) | Approach Velocity (m/s) | Immediate Survival (1 hr) (%) \pm 95% CI | Total Survival (1 hr + 48 hr) (%) \pm 95% CI |
|-----------------------|-------------------------|--|--|
| 123 | 1.5 | 100.0 \pm 0.0 | 101.3 \pm 4.8 |
| 126 | 2.0 | 100.0 \pm 0.0 | 100.0 \pm 0.0 |

Table 3-11

Percent of white sturgeon observed with external injuries during survival testing (T = treatment, C = control). The number of treatment fish assessed includes both turbine-passed fish and any fish that remained in the containment net upstream of the turbine until at the end of a trial because they could not be differentiated when fish were recovered from the flume. For each test group (T and C), the sum of the percents for each injury type may be higher than the total percent injured because some fish suffered multiple injuries.

| Approach Velocity (m/s) | Alive/Dead | Total Number Assessed | | Injured (%) | | Bruising (%) | | Eye Injury (%) | | Laceration (%) | |
|-------------------------|------------|-----------------------|----|-------------|-----|--------------|-----|----------------|-----|----------------|-----|
| | | T | C | T | C | T | C | T | C | T | C |
| 1.5 | alive | 71 | 72 | 0.0 | 0.0 | 0.0 | 0.0 | 0.0 | 0.0 | 0.0 | 0.0 |
| | dead | 1 | 2 | 0.0 | 0.0 | 0.0 | 0.0 | 0.0 | 0.0 | 0.0 | 0.0 |
| | total | 72 | 74 | 0.0 | 0.0 | 0.0 | 0.0 | 0.0 | 0.0 | 0.0 | 0.0 |
| 2.0 | alive | 74 | 76 | 8.2 | 2.6 | 8.2 | 2.6 | 0.0 | 0.0 | 0.0 | 0.0 |
| | dead | 0 | 0 | - | - | - | - | - | - | - | - |
| | total | 74 | 76 | 8.2 | 2.6 | 8.2 | 2.6 | 0.0 | 0.0 | 0.0 | 0.0 |

Behavioral Tests

The objectives of behavioral testing were to assess behavior and to estimate turbine entrainment rates of fish approaching the FFP turbine from a point of release about 1.5 m upstream of the unit and slightly above the centerline of the hub. The release system used for survival tests was also used to introduce fish into the flume during behavioral testing. However, for behavioral trials, once fish entered the flume they were able to proceed downstream without any restrictions on movement across the width and depth of the test channel, allowing them to avoid entrainment into the FFP turbine.

With the exception of five hybrid striped bass, all fish released during behavioral trials were recovered either upstream or downstream of the FFP turbine at the completion of each trial (Table 3-12). Due to the small size of some bass (< 100 mm), it is possible that the unrecovered fish left the test area by passing through the mesh of the downstream isolation screen. Although survival was not part of the behavioral testing analysis, recovered fish were classified as alive or dead during the collection process. Two small trout, one large trout, and no sturgeon were recovered dead during behavioral trials, whereas 86 hybrid bass were dead when recovered. Most of the bass mortalities occurred during trials conducted at the highest approach velocity (2.0 m/s) and likely resulted from impingement on the downstream screen following passage by or through the turbine. Also, the longer test duration of behavioral trials increased the susceptibility of fish to prolonged impingement.

After leaving the introduction pipe and entering the channel flow, rainbow trout and hybrid striped bass typically exhibited positive rheotaxis and proceeded downstream in a controlled manner (tail beating with some control of speed and directional movement) (Figure 3-1 and Figure 3-2). However, trout were more likely to actively avoid entrainment through lateral and/or vertical movements, whereas hybrid bass were more likely to continue downstream through the turbine. Unlike the active swimming of trout and bass, white sturgeon primarily appeared to passively drift downstream once entering the channel flow (Figure 3-3). White sturgeon is a benthic species with morphological traits and behavioral patterns that reflect the selection of bottom habitats. These attributes may reduce their swimming capabilities in flowing water when they are higher in the water column. This is particularly true for small juvenile sturgeon (< 200 mm in length), which may exhibit little or no swimming activity (i.e., only drifting) when in high velocity environments.

For the lighted test condition (day trials), the percentage of the two size groups of trout that moved downstream past the turbine (either through or around it) increased with velocity and was greater for the smaller trout at the two lower velocities evaluated (Table 3-13). At the highest test velocity (2.0 m/s), the percentage of trout recovered downstream of the turbine was similar between the two size groups (Table 3-13). For the dark test condition (night trials), the percentage of trout recovered downstream was considerably higher for both size groups than it was with the lighted condition at the same approach velocity (1.1 m/s). Also, downstream recovery for night tests was similar between the two size groups (Table 3-13). Fish that were not recovered downstream swam upstream after release and remained there for the duration of a trial; this behavior was most prevalent with trout tested at the two lowest velocities.

Table 3-12

Summary of behavioral testing release and recovery data for rainbow trout (RBT), white sturgeon (WST), and hybrid striped bass (HSB) evaluated with the FFP turbine.

| Species | Size Group | Approach Velocity (m/s) | Light Condition | Trials | Total Number Released | Number Recovered Downstream | Number Recovered Upstream | Number Recovered Dead | Total Number Recovered |
|---------|------------|-------------------------|-----------------|--------|-----------------------|-----------------------------|---------------------------|-----------------------|------------------------|
| RBT | small | 1.1 | day | 3 | 150 | 116 | 34 | 1 | 150 |
| | | | night | 3 | 150 | 144 | 6 | 0 | 150 |
| | | 1.5 | day | 3 | 150 | 142 | 8 | 0 | 150 |
| | | 2.0 | day | 3 | 150 | 149 | 1 | 2 | 150 |
| | large | 1.1 | day | 3 | 300 | 147 | 153 | 0 | 300 |
| | | | night | 3 | 300 | 285 | 15 | 0 | 300 |
| | | 1.5 | day | 3 | 300 | 207 | 93 | 0 | 300 |
| | | 2.0 | day | 3 | 300 | 299 | 1 | 1 | 300 |
| WST | small | 1.1 | day | 3 | 69 | 68 | 1 | 0 | 69 |
| | | | night | 3 | 69 | 69 | 0 | 0 | 69 |
| | | 1.5 | day | 3 | 69 | 69 | 0 | 0 | 69 |
| | | 2.0 | day | 3 | 69 | 68 | 1 | 0 | 69 |
| HSB | small | 1.1 | day | 3 | 150 | 145 | 4 | 17 | 149 |
| | | | night | 3 | 150 | 149 | 1 | 7 | 150 |
| | | 1.5 | day | 3 | 150 | 143 | 4 | 10 | 147 |
| | | 2.0 | day | 3 | 150 | 149 | 0 | 52 | 149 |

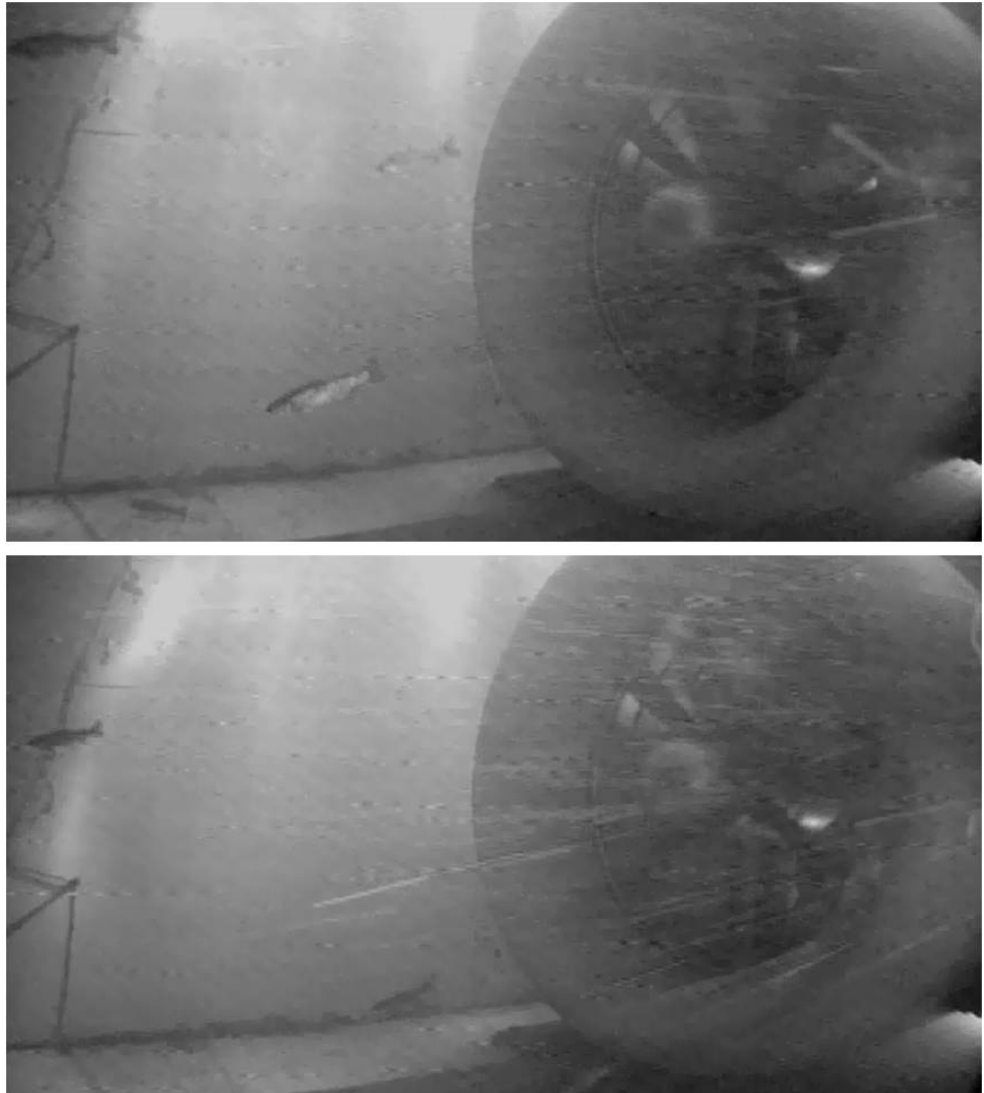

*Figure 3-1
Rainbow trout (125 mm size group) showing avoidance behavior as they move downstream past the turbine at an approach velocity of 1.5 m/s (5 ft/s).*

The percentage of the hybrid striped bass and white sturgeon that moved downstream past the turbine (either through or around it) was similar between the two species and among the three velocities evaluated, ranging from 98.6 to 100.0% for sturgeon and 97.3 to 100.0% for bass (Table 3-13). For both species, downstream recovery rates were also similar between the two light conditions evaluated (Table 3-13).

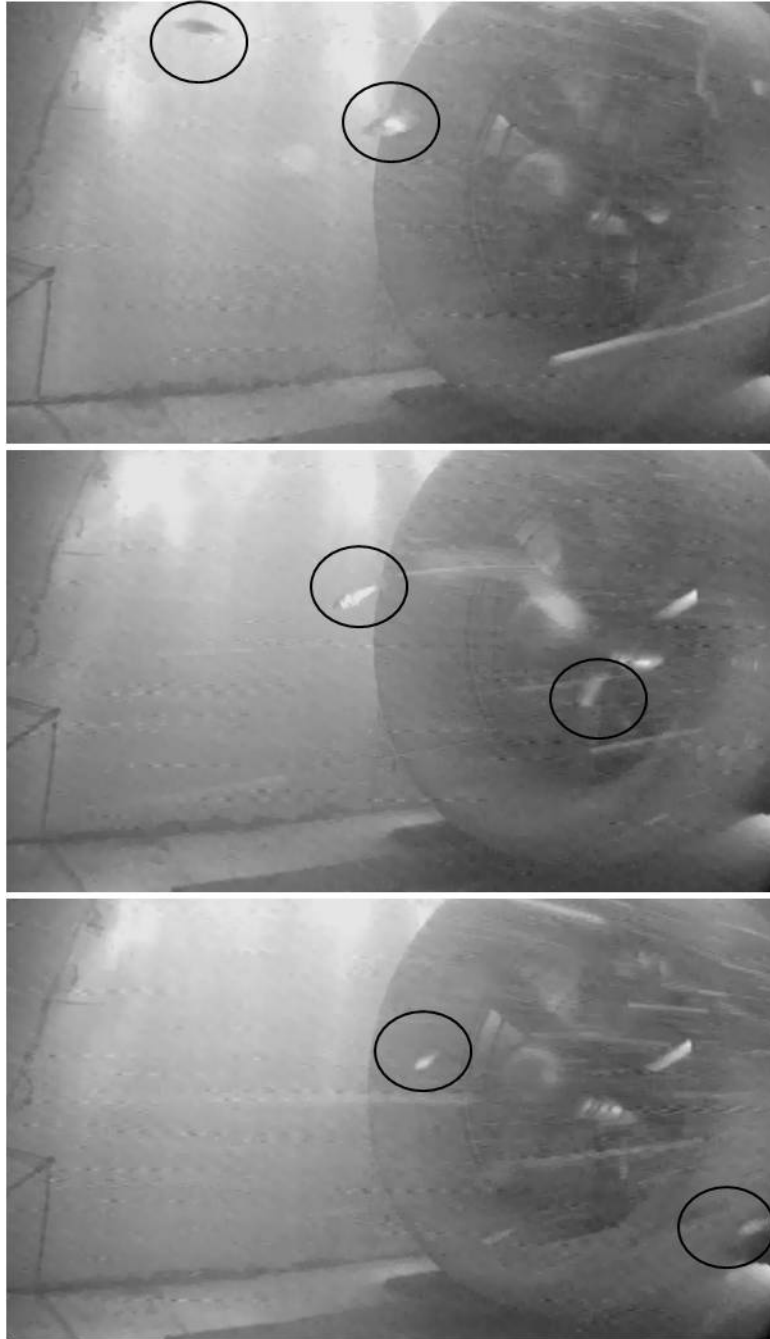

*Figure 3-2
Hybrid striped bass approaching the FFP turbine and passing downstream outside
the turbine duct (fish circled on right) and entrained through the turbine (fish circled
on left).*



Figure 3-3
White sturgeon passively moving downstream over the turbine duct at an approach velocity 1.5 m/s (5 ft/s).

Table 3-13

Turbine entrainment numbers and avoidance rate estimates from behavioral tests conducted with rainbow trout (RBT), white sturgeon (WST), and hybrid striped bass (HSB).

| Species | Size Group | Approach Velocity (ft/s) | Light Condition | % of Fish Recovered Downstream of Turbine | Estimate of Number Entrained | Turbine Avoidance (95% CI) (%) |
|---------|------------|--------------------------|-----------------|---|------------------------------|--------------------------------|
| RBT | small | 1.1 | Day | 77.3 | 3 | 97.4 (97.3 - 97.5) |
| | | | Night | 96.0 | 3 | 98.2 (96.4 - 99.4) |
| | | 1.5 | Day | 94.7 | 12 | 92.1 (74.4 - 99.8) |
| | | 2.0 | Day | 99.3 | 21 | 86.1 (74.7 - 94.5) |
| RBT | large | 1.1 | Day | 49.0 | 4 | 98.5 (85.8 - 100.0) |
| | | | Night | 95.0 | 5 | 98.1 (96.9 - 99.0) |
| | | 1.5 | Day | 69.0 | 8 | 96.5 (86.9 - 100.0) |
| | | 2.0 | Day | 99.7 | 14 | 95.4 (90.6 - 98.5) |
| WST | small | 1.1 | Day | 98.6 | 6 | 92.1 (68.4 - 99.9) |
| | | | Night | 100.0 | 9 | 87.4 (80.0 - 93.3) |
| | | 1.5 | Day | 100.0 | 9 | 87.9 (62.7 - 99.7) |
| | | 2.0 | Day | 98.6 | 0 | 100.0 (-) |
| HSB | small | 1.1 | Day | 97.3 | 59 | 59.3 (46.9 - 71.1) |
| | | | Night | 97.3 | 52 | 65.4 (57.1 - 73.2) |
| | | 1.5 | Day | 97.3 | 95 | 32.6 (0.0 - 89.1) |
| | | 2.0 | Day | 100.0 | 61 | 59.2 (23.6 - 90.1) |

Avoidance of turbine entrainment by the two size groups of rainbow trout was high (> 85%) for all three test velocities and both light conditions evaluated at 1.1 m/s (Table 3-13; Figure 3-4 and Figure 3-5). Avoidance decreased with increasing velocity and was higher for tests conducted under darkened conditions (nighttime simulation at 1.1 m/s). Avoidance rates were similar between size groups for tests at the lowest velocity (1.1 m/s), but were higher for the larger fish at the faster approach velocities (Table 3-13; Figure 3-4). However, differences in turbine avoidance probabilities were not statistically significant (two-factor ANOVA, $P > 0.05$) among test velocities within each size group, or between size groups within each velocity. Similarly, for both size groups, avoidance probabilities of trout were not statistically significant (two-factor ANOVA, $P > 0.05$) between the two light conditions evaluated (Figure 3-5).

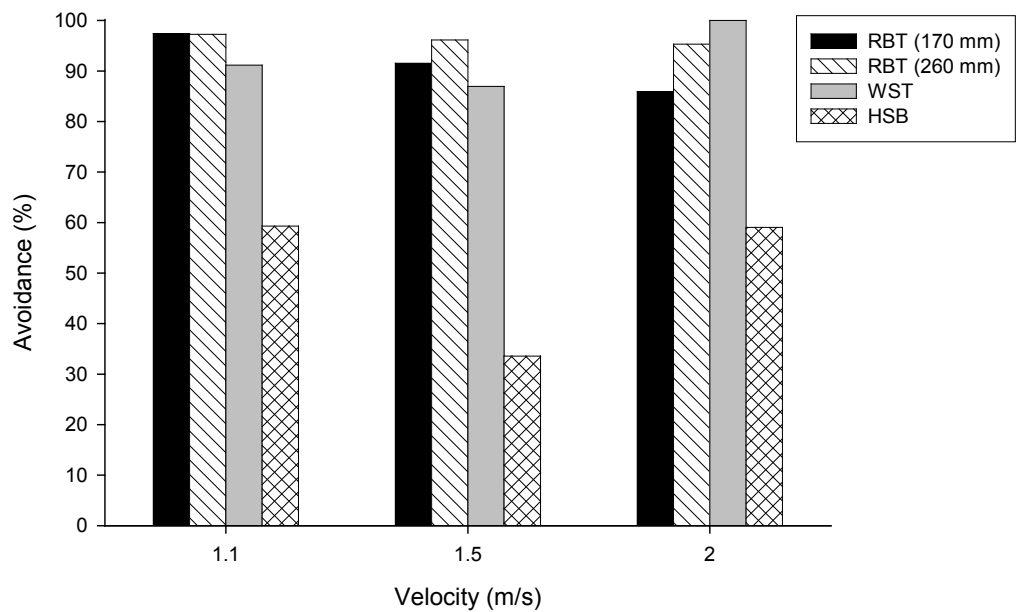

Figure 3-4
Turbine avoidance rates by velocity and species for the lighted flume test condition (daylight simulation).

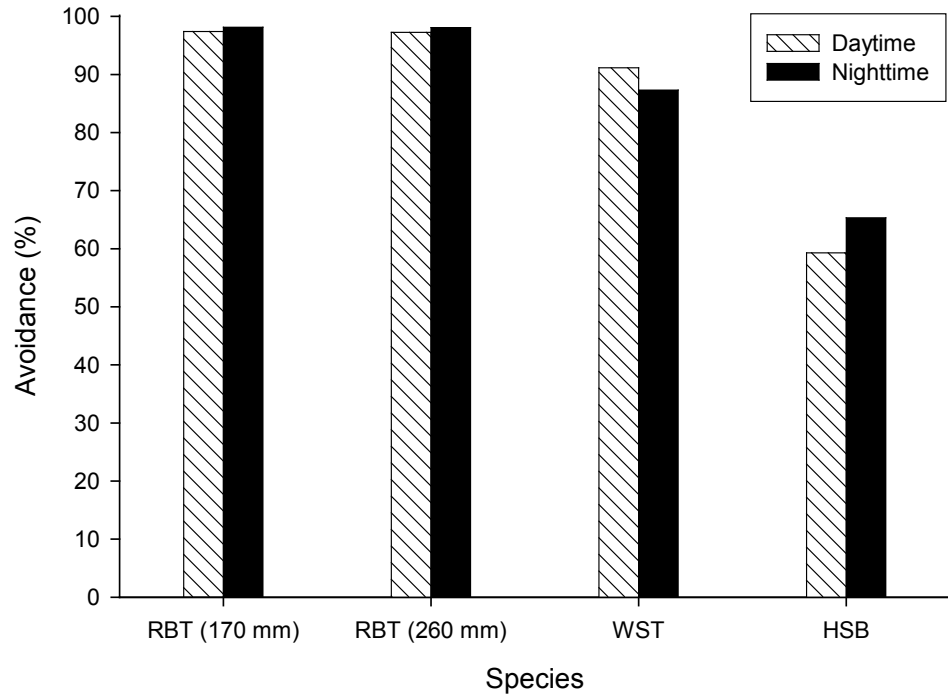

Figure 3-5
 Turbine avoidance by species for the darkened flume test condition (nighttime simulation). Tests with the darkened flume were only conducted at an approach velocity of 1.1 m/s.

Avoidance of turbine entrainment by sturgeon was also high (> 87%) for all three test velocities and both light conditions evaluated at 1.1 m/s (Table 3-13; Figure 3-4 and Figure 3-5). Unlike trout and hybrid striped bass, sturgeon avoidance appeared to be more passive with minimal active swimming and directional movement. Sturgeon typically rose slightly in the water column after exiting the release pipe and followed the flow streamlines accelerating around the outside of the turbine duct. As a result, sturgeon avoidance was significantly greater at the highest velocity tested under the daytime light condition than it was for the two lower velocities (two-factor ANOVA, $P < 0.05$) (Table 3-13; Figure 3-4). The difference between sturgeon avoidance rates at the two lower velocities tested under the lighted condition, as well as between the two light conditions tested at the lowest velocity, were not statistically significant (two-factor ANOVA, $P > 0.05$) (Table 3-13; Figure 3-4 and Figure 3-5).

Of the three species tested, hybrid striped bass had the lowest turbine avoidance rates (Table 3-13; Figure 3-4 and Figure 3-5). Avoidance rates for bass were essentially the same at the lowest and highest velocities tested under daytime light conditions, but considerably lower at the middle velocity (Table 3-13; Figure 3-4). For tests at the lowest velocity, avoidance was slightly higher for tests conducted without light than it was for tests with light (Table 3-13; Figure 3-5). Differences in avoidance among the three velocities and between the two light conditions tested at the lowest velocity were not statistically significant

(two-factor ANOVA, $P > 0.05$), most likely due to high variability in avoidance rates among replicate trials for each set of test conditions.

Total Passage Survival Estimates

Due to 100% turbine survival, both size groups of rainbow trout had total passage survival estimates of 100% at an approach velocity 1.5 m/s. At 2.1 m/s, total survival was greater than 99% for each size group. Total passage survival for white sturgeon was 100% at both test velocities due to 100% turbine survival at each velocity. Total survival for hybrid striped bass was 94% at the lower test velocity and 100% at the higher velocity. As discussed previously, one of the three trials conducted with bass at the lower velocity had higher delayed mortality than would normally be expected based on the results from tests at the higher velocity and with the other species. It is likely that turbine survival and total passage survival for bass at the lower velocity are at or near 100%. The ranges of total survival calculated with the lower and upper confidence intervals of turbine survival and avoidance estimates were very narrow for trout and sturgeon (lower limits were all greater than 98%), but wider ranges occurred for hybrid bass due to higher variability in the avoidance estimates among trials at each test velocity.

Table 3-14

Estimated total passage survival calculated for each velocity tested with rainbow trout (RBT), white sturgeon (WST), and hybrid striped bass (HSB) using turbine survival and avoidance estimates.

| Species | Approach Velocity (m/s) | Light Condition | Turbine Survival (%) (± 95% CI) | Turbine Avoidance (%) (95% CI) | Total Passage Survival (%) |
|-------------|-------------------------|-----------------|------------------------------------|-----------------------------------|---------------------------------|
| RBT (small) | 1.5 | day | 100.0 (-) | 92.1 (74.4 - 99.8) | 100.0 (-) |
| | 2.0 | day | 98.7 (97.6 - 99.9) | 86.1 (74.7 - 94.5) | 99.8 (99.4 - 100.0) |
| RBT (large) | 1.5 | day | 100.0 (-) | 96.5 (86.9 - 100.0) | 100.0 (-) |
| | 2.0 | day | 97.5 (96.2 - 98.9) | 95.4 (90.6 - 98.5) | 99.9 (99.6 - 100.0) |
| WST | 1.5 | day | 100.0 (96.5 - 100.0) | 87.9 (62.7 - 99.7) | 100.0 (98.7 - 100.0) |
| | 2.0 | day | 100.0 (-) | 100.0 (-) | 100.0 (-) |
| HSB | 1.5 | day | 91.1 (85.9 - 96.3) | 32.6 (0.0 - 89.1) | 94.0 ¹ (85.9 - 99.6) |
| | 2.0 | day | 100.0 (95.6 - 100.0) | 59.2 (23.6 - 90.1) | 100.0 (0.967 - 100.0) |

¹ Hybrid striped bass experienced a higher level of delayed mortality during one of the three turbine survival trials that was probably an experimental artifact rather than due to actual injury suffered during turbine passage. Based on results from tests with bass at the higher velocity and with the other species, it is likely that turbine survival and total passage survival for hybrid striped bass at the lower velocity are at or near 100%.



Section 4: Conclusions and Discussions

The turbine passage survival and avoidance data collected for the three species tested with the FFP turbine are valuable additions to the existing dataset developed from laboratory tests with two other turbine designs (EPRI 2011a) and from field tests with another axial-flow type unit (NAI 2009). All of the turbine passage survival tests conducted to date have demonstrated high survival rates for the species and size groups evaluated (typically 98 to 100%). The behavioral tests conducted with the FFP turbine also demonstrated a high degree of turbine entrainment avoidance (86 to 100%) for two of three species (rainbow trout and white sturgeon) evaluated and moderate rates of avoidance for the third species (hybrid striped bass; 32 to 65%). When survival rates are combined with avoidance rates, total passage survival estimates were typically very high (99-100%).

It has been demonstrated that strike probability for fish passing through conventional hydro turbines increases with fish length (Hecker and Allen 2005) and strike mortality increases with the ratio of fish length to blade thickness (i.e., for a given blade thickness, larger fish will have a higher probability of mortality) when strike speeds are sufficiently high to cause lethal injuries (EPRI 2011b). The relationship between fish length and strike probability and mortality should also hold true for hydrokinetic turbines. However, there were no statistical differences between survival rates of the two size groups of trout for either of the two approach velocities evaluated with the FFP turbine. This observation combined with results of tests with other hydrokinetic turbines (EPRI 2011a; NAI 2009) suggests fish length may not be an important factor in determining survival of fish passing through hydrokinetic turbines for the range of lengths and turbine operating conditions investigated. At higher approach velocities (e.g., > 3.0 m/s), fish length may have a greater effect on survival due to higher rotational speeds and strike velocities.

At the lower velocity tested with the FFP turbine, strike velocities were apparently low enough to prevent lethal injuries to fish struck by a blade, whereas at the higher velocity, some mortality occurred for both size groups of trout. Also, both size groups experienced more injuries at the higher velocity and the larger trout had greater injury and scale loss than smaller fish at both test velocities. For fish entrained through hydrokinetic turbines, these observations indicate injury, scale loss, and mortality may increase with fish size and approach velocity, but such increases may be inconsequential for fish lengths and approach velocities within the range of those tested during lab and field studies.

With the completion of the current study, turbine passage survival data have now been collected for fish entrained through three different pilot-scale turbines evaluated in a laboratory flume, two of which are ducted axial-flow designs and one that is a cross-flow unit (EPRI 2011a). There also has been one field study that evaluated turbine survival of several fish species passed through a full-scale ducted axial-flow turbine (NAI 2009). All of these studies reported total survival estimates that included immediate (1 hr) and delayed (48 hr) mortalities. The three turbines evaluated in the lab were tested at approach velocities of 1.5 and 2.1 m/s. With the exception of hybrid striped bass and the smaller size group of largemouth bass, the lowest survival rate reported for each species tested with these turbines occurred at the higher velocity (Table 4-1). Approach velocities varied from 1.7 to 3.0 m/s during field testing with a full-scale Hydro Green turbine (NAI 2009); an average of 2.3 m/s was used to calculate the tip speeds for comparison with the designs tested in the lab. The data from all of these tests indicate that survival rates of entrained fish, regardless of turbine design or fish size, are likely to be about 98 to 100% for full-scale hydrokinetic turbines (Table 4-1).

Table 4-1

Summary of design and survival data for fish passed through four different hydrokinetic turbines during lab and field tests. Tip strike velocities were estimated based on known (measured) design and operational parameters for the Free Flow, Welka UPG, and Lucid Spherical turbines, and from information provided by NAI (2009) for the Hydro Green turbine.

| Turbine | Design | Test Type | No. of Blades | Blade Leading Edge Thickness (mm) | Diameter (m) | Rotational Speed (rpm) | Tip Speed (m/s) | Tip Strike Speed (m/s) | Species | Mean Length or Range (mm) | Total Turbine Passage Survival (%) |
|-------------|-------------------|-----------|---------------|-----------------------------------|--------------|------------------------|-----------------|------------------------|--------------|---------------------------|------------------------------------|
| Free Flow | ducted axial-flow | lab | 7 | 15.2 | 1.5 | 64-84 | 5.1-6.7 | 5.3-7.0 | rbw trout | 170 | 98.7-100.0 |
| | | | | | | | | | rbw trout | 258 | 97.5-100.0 |
| | | | | | | | | | wht sturgeon | 125 | 100.0 |
| | | | | | | | | | hybrid bass | 125 | 91.1-100.0 |
| Welka UPG | ducted axial-flow | lab | 4 | 12.7 | 1.5 | 15-35 | 1.2-2.8 | 1.9-3.4 | rbw trout | 125 | 100.0 |
| | | | | | | | | | rbw trout | 239 | 99.4-100.0 |
| | | | | | | | | | lm bass | 125 | 99.8-100.0 |
| | | | | | | | | | lm bass | 242 | 99.6-100.0 |
| Hydro Green | ducted axial-flow | field | 3 | - | 3.7 | 21 | 4.0 | 4.7 | ylw perch | 118-235 | 99.0 |
| | | | | | | | | | bluegill | 115-208 | 99.0 |
| | | | | | | | | | ch catfish | 451-627 | 99.0 |
| | | | | | | | | | sm buffalo | 388-482 | 98.1 |
| | | | | | | | | | bm buffalo | 415-710 | 99.0 |
| Lucid | cross-flow | lab | 4 | 19.1 | 1.1 | 64-83 | 3.8-5.0 | 4.1-5.4 | rbw trout | 150 | 99.0-100 |
| | | | | | | | | | rbw trout | 250 | 98.4-100 |

The collective data from all of the turbine survival evaluations (lab and field) demonstrate the effects of certain turbine design and operational features on entrainment mortality. The FFP turbine, which had the most blades (7) and highest strike velocities, typically had the lowest survival rates, particularly when tests with rainbow trout are compared for the three turbines evaluated in the lab (the low survival of hybrid striped bass at a velocity of 1.5 m/s was likely an experimental effect not related to turbine passage). Turbine survival was highest for the Welka UPG and Hydro Green units which had the lowest strike velocities and fewest number of blades, respectively. Although there is some uncertainty in the strike velocity estimate of the Hydro Green turbine due to assumptions made about some of the operational parameters in the absence of actual data, high survival rates were observed for relatively large fish (i.e., considerably larger than fish evaluated during flume testing with the other turbine designs). These high survival rates (99%) likely resulted from strike velocities that are low enough to prevent mortality (i.e., less than 5 m/s). Survival rates of rainbow trout passed through the Lucid turbine were slightly lower than observed for tests with the Welka UPG, most likely because fish entrained through the Lucid turbine have to pass through the blade sweep twice due to the cross-flow design (i.e., greater strike probability). Also, the strike speed for the Lucid turbine at the higher test velocity (2.1 m/s) was above the threshold below which mortality is not expected to occur. Additionally, because fish could not be forced through the blade sweep of the Lucid turbine, as was done for the other turbine designs, the survival estimates for the Lucid unit include fish that actively avoided entrainment by passing around the device. If only fish that passed through the blade sweep could be used in the analysis, turbine survival rates for the Lucid turbine would likely be lower than those reported.

The behavioral tests conducted with the FFP turbine provided valuable data on the ability of fish to avoid entrainment when approaching a hydrokinetic turbine. During these tests, most rainbow trout (86.0 – 98.5%) and many hybrid striped bass (32.6 – 65.4%) were able to actively avoid turbine entrainment despite the relatively short distance between the release point and the turbine (1.5 m). Greater avoidance by trout compared to bass was probably primarily due to stronger swimming capabilities and behavioral responses associated with better adaption to high velocity environments. Sturgeon also had high turbine avoidance rates (similar to trout), but avoidance by this species appeared to be more passive than active. That is, sturgeon typically drifted upwards when entering the flume flow and followed the streamlines accelerating around the FFP turbine duct without any apparent directional swimming. This type of behavior has also been observed for juvenile lake sturgeon when released in the upper water column of a flume during tests with angled bar racks and louvers (Amaral et al. 2002) and is likely due to limited swimming capabilities when sturgeon are in flowing water and not in close proximity to the bottom. In contrast, juvenile lake and shortnose sturgeon were observed in close contact with the flume floor when released near the bottom (Amaral et al. 2002). In other laboratory studies, juvenile white and shortnose sturgeon were also observed holding position or moving downstream along the floor when released near the bottom during evaluations of narrow-spaced bar racks and various bypass

configurations (Kynard et al. 2005; ARL 2007, 2008, 2009). Because of their general preference for benthic habitats, the likelihood of sturgeon encountering hydrokinetic turbines higher in the water column will be low. Even if sturgeon do encounter a hydrokinetic turbine in the field, the laboratory data indicate avoidance may be high (> 85%) and survival of entrained fish could be 100%, depending on turbine design and operation and fish length.

Another important finding from the behavioral tests was avoidance rates were similar between light and dark test conditions for all three species tested. However, “night” tests could only be conducted with an approach velocity of 1.1 m/s because air entrainment at higher velocities interfered with the ability of the DIDSON acoustic camera to detect fish in the flume. The lack of visual cues under dark conditions may be of greater importance to the ability of fish to avoid entrainment at higher velocities. The similarity in turbine avoidance rates between light and dark conditions at the velocity tested demonstrates that hydraulic cues likely play an important role in fish being able to detect hydrokinetic turbines and avoid entrainment. Noise (acoustic and hydrodynamic stimuli) produced by rotating turbines may also play a role in avoidance under low visibility conditions. Detection and response of fish to turbine noise and hydrodynamic changes in flow will depend, in part, on sound pressure source levels, signal frequencies, background noise, and species-specific hearing capabilities.

Using the turbine survival and avoidance rates, it was possible to estimate total passage survival for fish that may encounter an FFP turbine and either pass around or through it, assuming survival of fish that avoid entrainment is 100%. Using the data from the flume tests, total passage survival estimates were essentially 100% (99.8 – 100%), with the exception of hybrid bass tested at the lower velocity (1.5 m/s). Due to the previously noted issue associated with high delayed mortality during one of three trials conducted with bass at this velocity, turbine survival of bass at this velocity is likely higher than was calculated (most likely about 100% based on the results of tests at the higher velocity).

A third aspect of fish and hydrokinetic turbine interactions is whether fish moving through an area with turbines will ever encounter a unit. For example, if a particular species or life stage typically moves downstream near shore, on the bottom, or near the surface of a river or tidal area, the probability that fish of such species or life stages may encounter a turbine will be low (assuming turbines are located near the middle of the water column). If encounter probabilities can be determined and incorporated into the analysis, total passage survival rates will be higher than those estimated using only turbine survival and avoidance rates. Encounter probabilities can be derived from information on species habitat preferences and known migratory patterns. Alternatively, tracking tagged fish approaching and passing turbines in field situations using radio or acoustic telemetry techniques can also provide this information.

The results of the fish survival tests with the FFP turbine have provided similar findings to those of survival tests with other hydrokinetic turbine designs conducted in the lab and field. The collective data indicate that turbine passage

survival for fish passing through most hydrokinetic turbine designs will be high (about 98 – 100%), but that certain design features (e.g., number of blades, rotational speed, blade leading edge thickness) can lead to slightly lower survival if they cause increases in blade strike and/or mortality from strike. Fish length will also influence survival rates if blade strike velocities exceed about 5 m/s. However, even for the FFP turbine, which had a large number of blades and strike velocities greater than 5 m/s at the highest approach velocity tested, the estimated turbine survival rate was 97.5% for the larger rainbow trout (mean length of 258 mm). When turbine survival rates are combined with encounter and avoidance probabilities, it seems likely that many hydrokinetic turbines will have total passage survival rates between 99 and 100%. Additional testing with other species and larger fish, either in the lab or field, would be useful, as well as testing at higher velocities (> 6.5 ft/s) that may result in greater turbine mortality due to higher blade strike speeds. Also, more information on encounter probabilities in the field for representative important or common species and life stages would allow for a more complete total survival prediction model to be developed. More detailed information on fish behavior (i.e., avoidance probabilities and mechanisms) in the vicinity of hydrokinetic turbines arrays could be combined with numeric flow modeling to produce fish behavior models that predict responses to proposed installations and total survival for single or multiple unit arrays.



Section 5: Literature Cited

Alden Research Laboratory (Alden). 2007. Evaluation of Downstream Passage Alternatives for Shortnose Sturgeon and American Eel. Prepared for the City of Holyoke, Massachusetts.

Alden Research Laboratory (Alden). 2008. Evaluation of Downstream Passage Alternatives for Shortnose Sturgeon. Prepared for the City of Holyoke, Massachusetts.

Alden Research Laboratory (Alden). 2009. 2008 Flume Study at Alden Research Laboratory: Evaluation of Downstream Passage Alternatives for Shortnose Sturgeon. Prepared for the City of Holyoke, Massachusetts.

Amaral, S. V., J. L. Black, B. J. McMahon, and D. A. Dixon. 2002. Evaluation of Angled Bar Racks and Louvers for Guiding Lake and Shortnose Sturgeon. American Fisheries Society Symposium 28:197-210.

Amaral, S., G. Hecker, M. Metzger, and T. Cook. 2003. 2002 Biological Evaluation of the Alden/Concepts NREC Turbine. In: Proceedings of Waterpower XIII. HCI Publications, St. Louis, Missouri.

Amaral, S. V., G. E. Hecker, P. Stacy, and D. A. Dixon. 2008. Effects of leading edge turbine blade thickness on fish strike survival and injury. Proceedings of Hydrovision 2008. HCI Publications, St. Louis, Missouri.

Basham, L. R., M. R. Delarm, J. B. Athern, and S. W. Pettit. 1982. Fish Transportation Oversight Team Annual Report, FY 1981: Transport Operations on the Snake and Columbia Rivers. NOAA Technical Memorandum NMFS F/NNR-2. Environmental and Technical Services Division, Northwest Regional Office, National Oceanic and Atmospheric Administration, National Marine Fisheries Service, Portland, OR.

Burnham, K. P., D. R. Anderson, G. C. White, C. Brownie, and K. H. Pollock. 1987. Design and Analysis for Fish Survival Experiments Based on Release-Recapture. American Fisheries Society Monograph 5.

EPRI (Electric Power Research Institute). 2008. Evaluation of the effects of turbine blade leading edge design on fish survival. Prepared by Alden Research Laboratory, Inc., EPRI Report No. 1014937.

EPRI (Electric Power Research Institute). 2011a. Fish Passage through Turbines: Applicability of Conventional Hydropower Data to Hydrokinetic Technologies. Prepared by Alden Research Laboratory, Inc., EPRI Report No. 1024638.

EPRI (Electric Power Research Institute). 2011b. Additional Tests Examining Survival of Fish Struck by Turbine Blades. Prepared by Alden Research Laboratory, Inc., EPRI Report No. 1024648.

Kynard, B., D. Pugh, and T. Parker. 2005. Experimental Studies to Develop Guidance and a Bypass for Shortnose Sturgeon at Holyoke Dam. Prepared for the City of Holyoke, Massachusetts.

Kynard, B., D. Pugh, and T. Parker. 2006. Experimental Studies to Develop Guidance and a Bypass for Shortnose Sturgeon at Holyoke Dam. Prepared for the City of Holyoke, Massachusetts.

NAI (Normandeau Associates, Inc.). 2009. An Estimation of Survival and Injury of Fish Passed through the Hydro Green Energy Hydrokinetic System, and a Characterization of Fish Entrainment Potential at the Mississippi Lock and Dam No. 2 Hydroelectric Project (P-4306), Hastings, Minnesota. Prepared for Hydro Green Energy LLC, Houston, Texas.

Neitzel, D. A., C. S. Abernethy, E. W. Lusty, and L. A. Prohammer. 1985. A Fisheries Evaluation of the Sunnyside Canal Fish Screening Facility, Spring 1985: Annual Report. U.S. Department of Energy Contract DE-AC06-76RLO 1830.

Skalski, J. R. 1999. Statistical Input to the Design and Analysis of the ARL/NREC Pilot Scale Fish-Friendly Turbine. Prepared for Alden Research Laboratory, Inc.

The Electric Power Research Institute, Inc. (EPRI, www.epri.com) conducts research and development relating to the generation, delivery and use of electricity for the benefit of the public. An independent, nonprofit organization, EPRI brings together its scientists and engineers as well as experts from academia and industry to help address challenges in electricity, including reliability, efficiency, affordability, health, safety and the environment. EPRI also provides technology, policy and economic analyses to drive long-range research and development planning, and supports research in emerging technologies. EPRI's members represent approximately 90 percent of the electricity generated and delivered in the United States, and international participation extends to more than 30 countries. EPRI's principal offices and laboratories are located in Palo Alto, Calif.; Charlotte, N.C.; Knoxville, Tenn.; and Lenox, Mass.

Together...Shaping the Future of Electricity

Program:

Waterpower Technology

© 2014 Electric Power Research Institute (EPRI), Inc. All rights reserved. Electric Power Research Institute, EPRI, and TOGETHER...SHAPING THE FUTURE OF ELECTRICITY are registered service marks of the Electric Power Research Institute, Inc.

3002003911