

EFFECTS OF EMFs FROM UNDERSEA POWER CABLES ON ELASMOBRANCHS AND OTHER MARINE SPECIES

Final Report

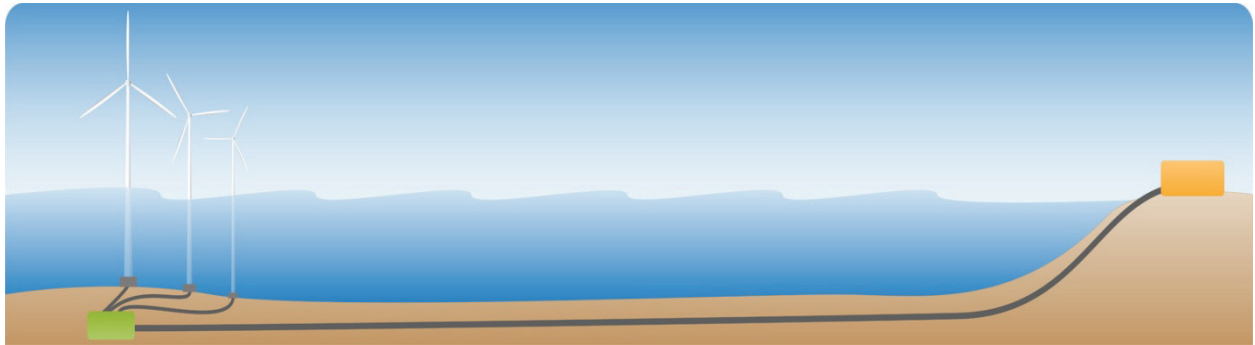

U.S. Department of the Interior
Bureau of Ocean Energy Management, Regulation and Enforcement
Pacific OCS Region

EFFECTS OF EMFs FROM UNDERSEA POWER CABLES ON ELASMOBRANCHS AND OTHER MARINE SPECIES

Final Report

Prepared by

**NORMANDEAU ASSOCIATES, INC.
EXPONENT, INC.
DR. TIMOTHY TRICAS
DR. ANDREW GILL**

**Prepared under BOEMRE Contract
M09P C00014**

**By
Normandeau Associates, Inc.
25 Nashua Rd.
Bedford, NH 03110**

Published by

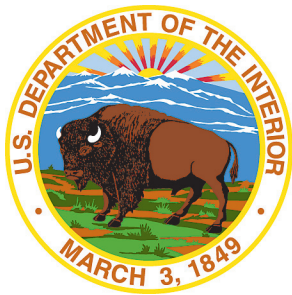

Pacific OCS Region
May 2011

DISCLAIMER

This study was funded by the Bureau of Ocean Energy Management, Regulation and Enforcement, U.S. Department of the Interior, Washington, D.C., under Contract Number M09PC00014.

REPORT AVAILABILITY

Extra copies of this report may be obtained from the Public Information Office at the following address:

U.S. Department of the Interior
Bureau of Ocean Energy Management, Regulation, and
Enforcement
Pacific OCS Region
770 Paseo Camarillo
Camarillo, California 93010

Telephone: 805-389-7533 or
1-800-672-2627

<http://www.gomr.boemre.gov/homepg/espis/espisfront.asp>

or from:

Normandeau Associates, Inc.
25 Nashua Rd.
Bedford, NH 03110

Telephone: 603-472-5191

CITATION

Suggested Citation:

Normandeau, Exponent, T. Tricas, and A. Gill. 2011. Effects of EMFs from Undersea Power Cables on Elasmobranchs and Other Marine Species. U.S. Dept. of the Interior, Bureau of Ocean Energy Management, Regulation, and Enforcement, Pacific OCS Region, Camarillo, CA. OCS Study BOEMRE 2011-09.

ACKNOWLEDGEMENTS

The following authors were responsible for individual chapters in the report:

Author (Affiliation)	Chapters	Topics
Ann Pembroke (Normandeau)	Executive Summary	Overall summary
	1	Introduction
	4.3.2	Research priorities for marine species
	4.4.2	Mitigation for marine species
	4.4.3	Monitoring of mitigation measures
	4.5	Cumulative impacts
Eric Nestler (Normandeau)	2	Methods
	3	Literature search results
	4.2.3	Other fishes
	4.2.6	Invertebrates
Melinda Sweeny (Normandeau)	4.2.4	Marine mammals
	4.2.5	Sea turtles
Dr. William Bailey (Exponent)	4.1	Power cables
	4.3.1	Research priorities for power cables
	4.4.1	Engineering solutions to reduce EMF
Dr. Vikas Anant (Exponent)	4.1	Power cables (modeling)
Dr. Timothy Tricas (University of Hawaii)	4.2.1	Magneto- and electroreception in marine species
	4.2.2	Elasmobranchs
	4.3.2	Data gaps and research priorities for marine species
Dr. Andrew Gill (Cranfield University)	1	Introduction
	4.3	Cumulative impacts

All contributed to significant editorial review of the report.

Table of Contents

	Page
Executive Summary	1
Power Cables	1
Magnetosensitive and Electrosensitive Marine Species	4
Data Gaps and Research Priorities.....	11
Mitigation and Monitoring.....	11
Cumulative Impacts	12
Conclusions.....	13
1. Introduction.....	15
1.1 NEPA Process	17
1.2 Types of Electromagnetic Fields.....	17
1.3 European Perspective	18
1.4 Organization of the Document	22
2. Methods.....	23
2.1 Literature Search Methods	23
2.2 Database Methods	24
2.2.1 Original Annotation	24
2.2.2 Keywords	24
2.2.3 Geographic Location.....	25
2.3 Power Cable Modeling Approach	25
2.3.1 Magnetic Field Levels for AC Cables	25
2.3.2 Magnetic Field Levels for DC Cables	26
2.3.3 Induced Electric Field Levels for AC cables	26
2.3.4 Induced Electric Field Levels for DC cables	27
2.4 Identification of Priority Species.....	27
3. Literature Search and Information Gathering Results (Task 1).....	29
3.1 Existing and Proposed Undersea Power Cables.....	29
3.2 Magnetosensitive and Electrosensitive Marine Species.....	29
4. Information Synthesis (Task 2).....	33
4.1 EMFs from Undersea Power Cables	33
4.1.1 EMFs in the Marine Environment	33
4.1.1.1 Electromagnetic Fields.....	33
4.1.1.2 Natural Sources of EMFs in the Ocean.....	34
The Geomagnetic Field.....	34
Induced Electric Fields.....	35
Bioelectric Fields	36
4.1.1.3 Anthropogenic Sources of EMFs in the Ocean.....	36
4.1.2 Review of Existing Information on Undersea Power Cables	37
4.1.2.1 Existing and Proposed Undersea Power Cables	37
4.1.2.2 Design Characteristics of AC Cables.....	38

4.1.2.3.	Design Characteristics of DC Cables.....	39
	Monopole System	39
	Bipole System	42
4.1.3.	Expected EMF Levels from Undersea Power Cables.....	42
4.1.3.1.	AC Magnetic Fields	43
4.1.3.2.	DC Magnetic Fields	45
4.1.3.3.	Direct Electric Fields	48
4.1.3.4.	Induced Electric Fields.....	49
4.1.3.5.	EMFs During Non-Normal Conditions.....	50
4.2.	Magnetosensitive and Electrosensitive Marine Species.....	50
4.2.1.	Magneto and Electroreception in Marine Species	51
4.2.1.1.	Sensory Systems in Marine Species.....	51
4.2.1.2.	Magnetoreception.....	52
4.2.1.3.	Electroreception	53
4.2.1.4.	Potential Impacts to Marine Species from Anthropogenic EMFs ...	54
4.2.2.	Elasmobranchs	54
4.2.2.1	Review of Existing Information.....	54
	Evidence Basis for Sensitivity to EMFs	54
	Electroreceptor Anatomy and Physiology	54
	Mechanisms of Magnetoreception in Elasmobranch Fishes.....	59
	Functional Roles for the Electrosense.....	60
	Preliminary Listing of Elasmobranch Species	61
4.2.2.2	Effects of EMFs from Undersea Power Cables	61
	Comparison of Expected EMF Levels to Reported	
	Sensitivities.....	61
	AC Cable Systems	61
	DC Cable Systems	62
	Direct Magnetoreception	62
4.2.2.3	Potential Impacts to Elasmobranchs	63
	Migrations	63
	Non-Migratory Species and Habitat Use	63
	Feeding Behavior	63
	Reproductive Behavior	63
	Nursery Grounds.....	64
4.2.2.4	Priority Species by Region.....	64
4.2.2.5	Case Study of the Sandbar Shark <i>Carcharhinus plumbeus</i>	66
	Conclusion	68
4.2.3.	Other Fishes	69
4.2.3.1	Review of Existing Information.....	69
	Evidence Basis for Sensitivity to EMFs	69
	Electroreception	69
	Magnetoreception.....	74
	Preliminary Listing of Other Fish Species.....	75
4.2.3.2	Effects of EMFs from Undersea Power Cables	75
	Comparison of expected EMF levels to reported sensitivities.....	75
	Potential Impacts to Other Fishes	77

4.2.3.3	Priority Species by Region.....	78
4.2.3.4	Case Study of the Sockeye Salmon <i>Oncorhynchus nerka</i>	85
	Conclusion	87
4.2.4.	Marine Mammals.....	88
4.2.4.1	Review of Existing information.....	88
	Evidence of Magnetic Sensitivity	90
	Relationship to Geomagnetic Field.....	90
	Anatomical Evidence	92
	Behavioral and Physiological Reactions.....	92
	Preliminary Listing of Marine Mammal Species.....	92
4.2.4.2	Effects of EMF from Undersea Cables	94
	Comparison of expected EMF levels to reported sensitivities.....	94
	Potential Effects On Marine Mammals.....	94
4.2.4.3	Priority Species by Region.....	96
4.2.4.4	Case Study of the Bottlenose Dolphin <i>Tursiops truncatus</i>	98
	Available Magnetic Intensity Information.....	100
	Conclusion	100
4.2.5.	Sea Turtles	101
4.2.5.1	Review of Existing information.....	101
	Evidence Basis for Sensitivity	101
	Long Range and Short Range Migration	103
	Preliminary Listing of Sea Turtle Species	104
4.2.5.2	Effects of EMF from Undersea Cables	104
	Comparison of Expected EMF Levels to Reported Sensitivities.....	104
	Potential Effects On Sea Turtles	105
4.2.5.3	Priority Species by Region.....	105
4.2.5.4	Case Study of the Loggerhead Sea Turtle <i>Caretta caretta</i>	107
	Conclusion	109
4.2.6.	Invertebrates.....	109
4.2.6.1	Review of Existing Information.....	109
	Evidence Basis for Sensitivity to EMFs	109
	Electroreception	110
	Magnetoreception.....	110
	Preliminary Listing of Invertebrate Species.....	113
4.2.6.2	Effects of EMFs from Undersea Power Cables	114
	Comparison of expected EMF levels to reported sensitivities.....	114
	Potential Impacts to Invertebrates.....	115
4.2.6.3	Priority Species by Region.....	115
4.2.6.4	Case Study of the Caribbean Spiny Lobster <i>Panulirus argus</i>	117
	Conclusion	121
4.3	Data Gaps and Research Priorities	121
4.3.1	Data Gaps and Research Priorities for Power Cables.....	122
4.3.2	Data Gaps and Research Priorities for Marine Species	123
	4.3.2.1 Data gaps.....	123
	4.3.2.2 Research priorities.....	124

	Response to and Consequences of Cable EMFs	126
	Magnetosensory Biology	128
	Natural History.....	129
4.3.2.3	Specific Research Opportunities.....	130
	Priority Mesocosm Studies	130
	Priority Laboratory Studies.....	131
	Statistical Studies	131
4.4	Mitigation	132
4.4.1	Engineering Solutions to Reduce EMF.....	132
4.4.2	Marine Species.....	135
4.4.2.1	Secondary Effects of Engineering Solutions	136
4.4.2.2	Other Types of Mitigation.....	137
4.4.3	Monitoring of Mitigation Measures.....	137
4.5	Potential Cumulative Effects of EMFs on Marine Species.....	138
5.	Conclusions.....	143
6.	References.....	145
7.	Glossary	169
Appendices		
	Appendix A Literature Search Results	A-1
Appendix A-1	Power Cable Characteristics	A-4
Appendix A-2	EMF Impacts.....	A-17
Appendix A-3	General Electro – or Magnetosensitivity	A-27
Appendix A-4	Elasmobranchs – Electric Sense	A-39
Appendix A-5	Elasmobranchs – Magnetic Sense.....	A-69
Appendix A-6	Other Fishes – Electric Sense.....	A-75
Appendix A-7	Other Fishes – Magnetic Sense.....	A-87
Appendix A-8	Marine Mammals – Electric Sense	A-99
Appendix A-9	Marine Mammals – Magnetic Sense.....	A-101
Appendix A-10	Sea Turtles – Magnetic Sense	A-103
Appendix A-11	Invertebrates – Electric Sense.....	A-113
Appendix A-12	Invertebrates – Magnetic Sense	A-115
Appendix B	Undersea Cable Projects and AC and DC Magnetic Field Modeling	B-1
Appendix C	Biological Information	C-1

List of Figures

		Page
Figure ES-1.	Modeled average and range of magnetic field strength at the seabed surface over 10 AC cables.	2
Figure ES-2.	Modeled averaged and range of magnetic field strength at the seabed surface over nine DC cables.	3
Figure 1.0-1	US Department of the Interior, Bureau of Ocean Energy Management, Regulation and Enforcement (BOEMRE) offshore administrative boundaries on the Outer Continental Shelf in the Alaska, Atlantic, Gulf of Mexico, and Pacific Regions encompassed in this study. Planning areas in Alaska have been grouped into three regions.	16
Figure 4.1-1.	Map of total intensity of main geomagnetic field (Contour interval 1,000 nT; NOAA, 2010).	35
Figure 4.1-2.	Example of the layout of an offshore wind project. The location of each turbine is marked by an ‘x.’ The AC electricity generated by 48 wind turbines is carried over 36-kV inter-array cables to a transformer platform (orange cross). The voltage of the electricity is stepped up to 145 kV for export to shore (modified from Vattenfall, 2009).	37
Figure 4.1-3.	Configuration of a high voltage AC export cable showing three phase conductors and surrounding sheathing (Nexans 2009).....	38
Figure 4.1-4.	Example of a monopolar DC cable system with a separate return conductor (SRC) (Exponent 2001).	40
Figure 4.1-5.	Monopolar DC cable system with an SRC (TPC 2001)	40
Figure 4.1-6.	Monopolar DC cable system using coaxial cable with an IRC (Exponent 2001).	41
Figure 4.1-7.	AC magnetic field profiles across the surface of the seabed for 10 submarine cable systems. Note that the profiles from Horns Rev 2 Offshore Wind Farm and the Nysted Offshore Wind Farm almost completely overlap each other.	43
Figure 4.1-8.	Average AC magnetic field (blue) calculated at seabed surface for various projects (see Figure 4.1-7 legend for list of projects).	44
Figure 4.1-9.	DC magnetic field calculated at seabed surface for 9 submarine projects using buried bipolar and monopolar (with cable return) HVDC undersea cables. Note that the profiles for the Basslink Interconnector and the EirGrid Irish Interconnector Project almost completely overlap each other.	45
Figure 4.1-10.	Average DC magnetic field (blue) calculated at seabed surface for various projects. The SwePol Link project profile was omitted from this	

	plot because its cable configuration is anomalous compared to others that were modeled.	46
Figure 4.1-11.	Modeled profile of DC magnetic field from NaiKun \pm 200kV cable operating at 400 MW (Exponent and Hatch 2009).....	47
Figure 4.1-12.	Modeled profile of DC magnetic field from NaiKun \pm 200 kV cable operating at 400 MW when orientated NNE in the Hecate Strait off British Columbia (Exponent and Hatch 2009).....	48
Figure 4.2.1.	Sandbar Shark	66
Figure 4.2-2.	Sandbar Shark HAPC (NMFS 2010b).....	67
Figure 4.2.3.	Sockeye salmon range (NMFS 2010a)	86
Figure 4.2-4.	Bottlenose dolphin.	98
Figure 4.2-5.	Worldwide distribution of bottlenose dolphin.	98
Figure 4.2-6.	Loggerhead turtle.	107
Figure 4.2-7.	Worldwide distribution of loggerhead turtles (NMFS 2010a).....	108
Figure 4.2-8.	Caribbean spiny lobster.....	117
Figure 4.2-9.	Spiny Lobster EFH (GMFMC 2004).....	119
Figure 4.4-1.	Magnetic field profiles at the seabed surface for a DC cable buried 1 m below the seabed. Vertical axis shows the magnetic field per 1000 Amperes of balanced current (in either a bipolar or monopolar with return cable system).	133
Figure 4.4-2.	Magnetic field profiles at seabed level for an AC cable buried 0.5 m, 1 m, 1.5 m, or 2 m. Vertical axis shows the magnetic field per 1000 Amperes of line current in the buried 3-phase cables.....	134
Appendix Figure B-1.	AC magnetic field profiles across the surface of the seabed for 10 submarine cable systems. Note that the profiles from Horns Rev 2 Offshore Wind Farm and the Nysted Offshore Wind Farm almost completely overlap each other.....	B-29
Appendix Figure B-2.	DC magnetic field calculated at seabed surface for 9 submarine projects using buried bipolar and monopolar (with cable return) HVDC undersea cables. Note that the profiles for the Basslink Interconnector and the EirGrid Irish Interconnector Project almost completely overlap each other.	B-30

List of Tables

	Page
Table ES-1. AC magnetic fields (μT) reflecting averaged values from 10 AC projects at intervals above and horizontally along the seabed assuming 1m burial.....	2
Table ES-2. DC magnetic fields (μT) reflecting averaged values from 8 projects at intervals above and horizontally along the seabed assuming 1m burial.....	3
Table ES-3. Modeled average induced electric field from DC submarine cables (V/m) at distances above seabed and horizontally along seabed for cables buried 1m below seabed for a 5 knot current.....	4
Table ES-4. Electro- (E) and magnetosensitivity (M) in marine fish – summary of knowledge.....	5
Table ES-5. Electro- (E) and magnetosensitivity (M) in marine mammals, sea turtles, and invertebrates – summary of knowledge.....	6
Table ES-6. Summary of case history impact assessment.....	8
Table 1.0-1. Capacity of operational offshore wind projects in Europe at the end of 2010.....	19
Table 3.2-1 Number of general references covering electro or magnetoreception and EMF impacts by reference type.....	30
Table 3.2-2 Number of references selected for each group of marine organisms by subject and reference type.....	31
Table 4.1-1 Undersea power cable designs for submarine crossings and offshore wind projects.....	42
Table 4.1-2. AC magnetic fields (μT) reflecting averaged values from 10 projects at intervals above and horizontally along the seabed assuming 1m burial.....	45
Table 4.1-3 DC magnetic fields (μT) reflecting averaged values from 8 projects at intervals above and horizontally along the seabed assuming 1m burial.....	47
Table 4.1-4 Modeled average induced electric field from DC submarine cables (V/m) at distances above seabed and horizontally along seabed for cables buried 1m below seabed for a 5 knot current.....	49
Table 4.1-5 Modeled maximum induced electric field (V/m) in a small shark at various distances above a 60 Hz, AC submarine cables (for averaged designs) buried 1m below seabed.....	50
Table 4.2-1 Listing of elasmobranch species for which information on sensitivity to electric or magnetic fields has been reported.....	55
Table 4.2-2 Regulatory Status and Geographic Distribution of Elasmobranch Order in US Waters Within BOEMRE Planning Areas and Regions of Alaska.....	65
Table 4.2-3 Marine fish species (non-elasmobranch) for which information on sensitivity to electric or magnetic fields has been reported.....	70

Table 4.2-4 Federally listed threatened (T) or endangered (E) fish species (non-elasmobranch) in US waters (NMFS 2010a).....	76
Table 4.2-5 Characteristics of priority fish species (non-elasmobranch) in US waters and behavior potentially affected by electric or magnetic fields.....	79
Table 4.2-6 Geographic distribution of priority fish species (non-elasmobranch) within BOEMRE planning areas and regions of Alaska.	82
Table 4.2-7 Listing of marine mammals for which information on sensitivity to electric or magnetic fields has been reported.	89
Table 4.2-8 Species for which live stranding locations from Texas to Maine were significantly correlated to geomagnetic minima. Kirschvink 1990.....	91
Table 4.2-9 Federally listed endangered (E), threatened (T), delisted, and depleted marine mammals in US waters.	93
Table 4.2-10 Characteristics of priority marine mammal species in US waters and behavior potentially affected by magnetic field.	95
Table 4.2-11 Characteristics of marine mammals in US waters and behavior potentially affected by magnetic field.	97
Table 4.2-12 Geographic distribution of marine mammals within BOEMRE planning areas and regions of Alaska.....	99
Table 4.2-13 Listing of sea turtles for which information on sensitivity to electric or magnetic fields has been reported.....	102
Table 4.2-14 Federally listed threatened (T) or endangered (E) sea turtles in US waters. Source: NMFS 2010a.....	105
Table 4.2-15 Characteristics of sea turtles in US waters and behaviors potentially affected by exposure to magnetic fields.	106
Table 4.2-16 Geographic distribution of sea turtles within BOEMRE planning areas and regions of Alaska.	107
Table 4.2-17 Listing of marine invertebrates for which information on sensitivity to electric or magnetic fields has been reported.....	111
Table 4.2-18 Federally listed threatened (T) or endangered (E) marine invertebrates in US waters (NMFS 2010a).	114
Table 4.2-19 Characteristics of priority invertebrate species in US waters and behavior potentially affected by exposure to electric or magnetic fields.	116
Table 4.2-20 Geographic distribution of priority invertebrate species within BOEMRE planning areas and regions of Alaska.	118
Table 4.3-1. Initial Research Needs by Planning Area.....	125
Table 4.4-1. Effectiveness of Potential Magnetic Field Reduction Strategies.	135
Appendix Table B-1. Summary of information on existing and proposed undersea power cables. Existing and proposed undersea power cables.	B-4

Appendix Table B-2. Table of average AC magnetic fields computed for various projects at distances along and above seabed.	B-7
Appendix Table B-3. Maximum induced Root Mean Square (RMS) electric field averaged over various projects with AC undersea cables for species located directly above and parallel to the cable ^a assuming 5 knot current or swimming speed.	B-9
Appendix Table B-4. Table of average DC magnetic fields computed for various projects at distances along and above seabed.	B-10
Appendix Table B-5. Average induced electric field computed for various projects with DC undersea cables at distances along and above seabed for a sea current of 5 knots flowing parallel to the cables.	B-12
Appendix Table B-6. Average induced electric field computed for various projects with DC undersea cables at distances along and above seabed for a sea current of 5 knots flowing perpendicular to the cables.	B-14
Appendix Table B-7. DC magnetic field (per 1000 Amperes of balanced current) calculated for cables buried 1 m below the seabed surface, and separated by 0.5 m.	B-16
Appendix Table B-8. DC magnetic field (per 1000 Amperes of balanced current) calculated for cables buried 1 m below the seabed surface, and separated by 1 m.	B-18
Appendix Table B-9. AC magnetic field (per 1000 Amperes of line current) calculated for cable buried 0.5 m below the seabed surface.	B-20
Appendix Table B-10. AC magnetic field (per 1000 Amperes of line current) calculated for cable buried 1 m below the seabed surface.	B-22
Appendix Table B-11. AC magnetic field (per 1000 Amperes of line current) calculated for cable buried 1.5 m below the seabed surface.	B-24
Appendix Table B-12. AC magnetic field (per 1000 Amperes of line current) calculated for cable buried 2 m below the seabed surface.	B-26
Appendix Table B-13. Pacific electric cables to oil platforms.	B-28
Appendix Table C-1 Worldwide listing of elasmobranch species for which information on sensitivity to electric or magnetic fields has been suggested or studied, along with related species from US waters and any federally listed threatened (T) or endangered (E) species.	C-4
Appendix Table C-2 Natural history characteristics of elasmobranch species in US waters.	C-20
Appendix Table C-3 Geographic range of elasmobranch species in US waters.	C-32
Appendix Table C-4 Geographic distribution of elasmobranch species within MMS planning areas and regions of Alaska.	C-39
Appendix Table C-5 Worldwide listing of marine fish species (non-elasmobranch) for which information on sensitivity to electric or magnetic fields has	

	been suggested or studied, along with related species from US waters and any federally listed threatened (T) or endangered (E) species.	C-51
Appendix Table C-6	Natural history characteristics of priority fish species (non-elasmobranch) in US waters. Status= threatened (T) or endangered (E)	C-64
Appendix Table C-7	Geographic range of priority fish species (non-elasmobranch) in US waters.....	C-73
Appendix Table C-8	Worldwide listing of marine mammals for which information on sensitivity to magnetic fields has been suggested or studied, along with related species from US waters and any federally listed threatened (T) or endangered (E) species.....	C-78
Appendix Table C-9	Natural history characteristics of priority marine mammal species in US waters.	C-80
Appendix Table C-10	Geographic range of priority marine mammal species in US waters.....	C-82
Appendix Table C-11	Worldwide listing of sea turtles for which information on sensitivity to magnetic fields has been suggested or studied, along with related species from US waters and any federally listed threatened (T) or endangered (E) species.....	C-84
Appendix Table C-12	Natural history characteristics of sea turtles in US waters.....	C-87
Appendix Table C-13	Geographic range of sea turtles in US waters.	C-88
Appendix Table C-14	Worldwide listing of marine invertebrates for which information on sensitivity to electric or magnetic fields has been suggested or studied, along with related species from US waters and any federally listed threatened (T) or endangered (E) species.	C-89
Appendix Table C-15	Natural history characteristics of priority invertebrate species in US waters.	C-94
Appendix Table C-16	Geographic range of priority invertebrate species in US waters.	C-95

Unit Definitions and Conversion

Current		
Ampere	A	1 A
Milliampere	mA	0.001 A
Microampere	μ A	0.000001 A
Current density mA/m ²		
Voltage		
Volt	V	1 V
Kilovolt	kV	1000 V
Millivolt	mV	0.001 V
Microvolt	μ V	0.000001 V
Nanovolt	nV	0.000000001 V
Electric Field		
V/m	volt/m	
mV/m	0.001 V/m	
V/cm	100 V/m	
mV/cm	0.001 V/cm	
μ V/cm	0.000001 V/cm	
nV/cm	0.000000001 V/cm	
Magnetic Flux Density (B) - aka Magnetic Field¹		
Tesla	T	1 Weber/m ²
Millitesla	mT	0.001 T
Microtesla	μ T	0.000001 T = 10 mG
Nanotesla	nT	0.000000001 T
Gauss	G	
Milligauss	mG	0.001 G = 0.1 μ T

¹ The relationship between magnetic flux density (B) and magnetic field (H) is given by $B = \mu H$ where μ is the magnetic permeability of the medium. The permeability of biological materials and water is similar to that of air μ_0 so that $1 \text{ T} = 7.96 \times 10^5 \text{ A/m}$.

EXECUTIVE SUMMARY

Anthropogenic electromagnetic fields (EMFs) have been introduced into the marine environment around the world and from a wide variety of sources for well over a century. Despite this, little is known about potential ecological impacts from EMFs. For decades, power transmission cables have been installed across bays and river mouths, and connecting near-shore islands to the mainland, with little consideration of possible effects to marine species from EMFs. At a time of greater environmental awareness, the US now faces the possibility of a new source of EMFs over a much greater extent of the seabed from offshore renewable energy facilities in coastal waters. This literature review synthesizes information on the types of power cables and models the expected EMFs from representative cables. Available information on electro- and magneto-sensitivity of marine organisms, including elasmobranchs (sharks and rays) and other fish species, marine mammals, sea turtles, and invertebrates is summarized and used in conjunction with the power cable modeling results to evaluate the level of confidence the existing state of knowledge provides for impact assessment. Gaps in our knowledge of power cable characteristics and the biology needed to understand and predict impacts are summarized and form the basis of recommendations for future research priorities. Potential mitigation opportunities are described with a discussion of their potential secondary impacts as well as suggested methods for monitoring mitigation effectiveness. Finally, because interest in offshore renewable energy has increased throughout US coastal waters, there is a concern that organisms could be exposed to multiple seabed power cables. Cumulative effects of this exposure are discussed.

POWER CABLES

AC power transmission cables are the industry standard for offshore renewable energy facilities in Europe and those proposed in the US (to date, mostly wind power). DC cables will likely be used more often for future projects that are sited farther from shore. Except for the unlikely proposition of a DC cable system using sea electrodes (or for unshielded cables), it is common practice to block the direct electric field from the external environment by using conductive sheathing. Thus, the EMFs from both AC and DC power cables emitted into the marine environment are the magnetic field and the resultant induced electric field.

Design characteristics of 24 undersea cable projects were used to model expected magnetic fields. For eight of the ten AC cables modeled, the intensity of the field was roughly a direct function of the voltage (ranging from 33 to 345 kV) on the cables, although separation between the cables and burial depth also influenced field strength. The predicted magnetic field for these cables was strongest directly over the cables and decreased rapidly with vertical and horizontal distance from the cables. In projects where the current is delivered along two sets of cable that were separated by at least several meters, the magnetic field appeared as a bimodal peak. The range and average magnetic field strength for these cables directly above the seabed is depicted in Figure ES-1. Strength of the magnetic field emitted by AC cables declined with both vertical and horizontal distance from the source. Assuming average characteristics of the cables examined in this study, the vertical and horizontal decay of the field strength is shown in Table ES-1. The frequency rating of AC cables indicates the rate at which the current flow reverses; a 50 Hz current (the common rating for European cables) reverses 50 times per second and a

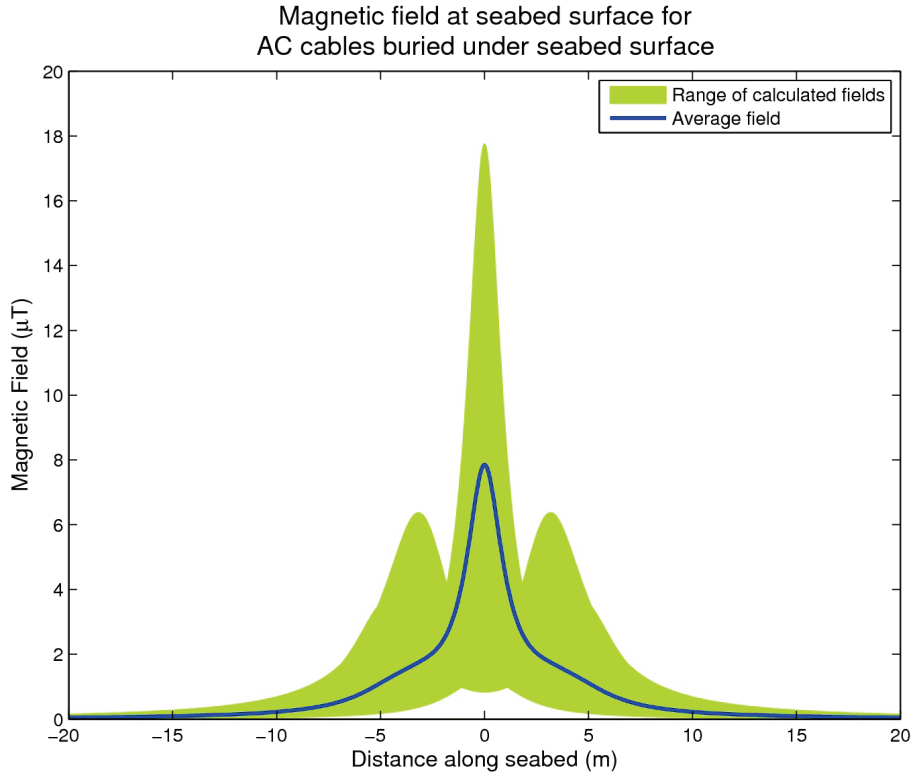

Figure ES-1. Modeled average and range of magnetic field strength at the seabed surface over 10 AC cables.

Table ES-1.

AC magnetic fields (μT) reflecting averaged values from 10 AC projects at intervals above and horizontally along the seabed assuming 1m burial.

Distance (m) Above Seabed	Magnetic Field Strength (μT)		
	Horizontal Distance (m) from Cable		
	0	4	10
0	7.85	1.47	0.22
5	0.35	0.29	0.14
10	0.13	0.12	0.08

60 Hz current (the common rating for US cables) reverses 60 times per second. The resultant magnetic field reverses at this same rate.

Magnetic fields resulting from nine DC cable systems were also modeled. Similar to AC cables, the strength of the magnetic field around DC cables was a function of voltage (ranging from 75 to 500 kV) and cable configuration. Proximity of the outflow and return cables to one another affected the field intensity because fields from opposing currents are subtractive. The average field generated by these cables, without accounting for the influence of the Earth's magnetic field (geomagnetic field), is shown in Figure ES-2. As with AC cables, the field strength is at its

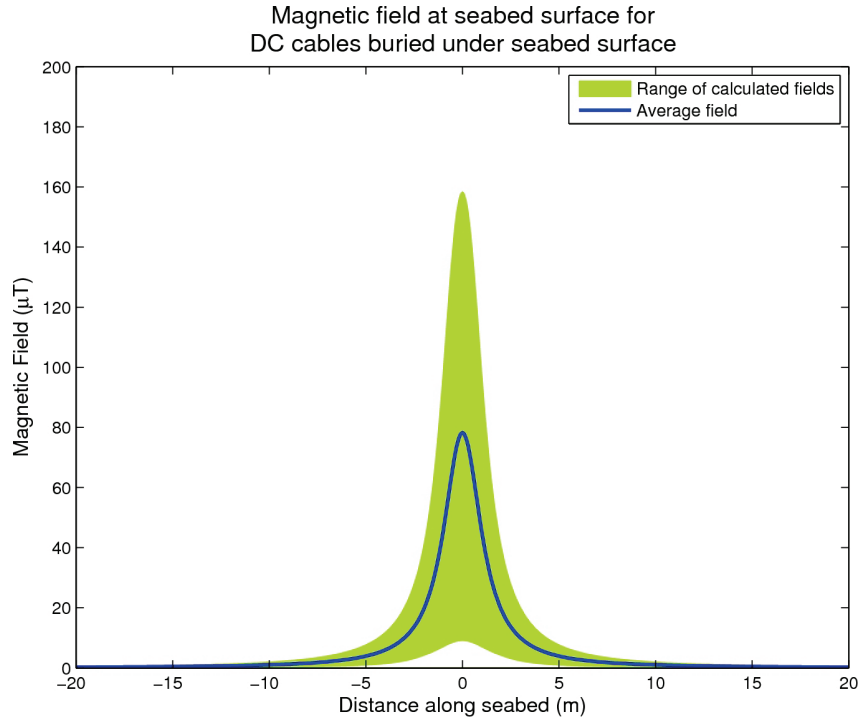

Figure ES-2. Modeled averaged and range of magnetic field strength at the seabed surface over nine DC cables.

maximum directly above the cable and declines with both vertical and horizontal distance from the source and the decay of an “average” field is shown in Table ES-2. Unlike the magnetic field from AC cables, however, the magnetic field from DC cables can influence the intensity of the local geomagnetic field, as well as its inclination and declination, thus the orientation of the cable relative to the geomagnetic field should be accounted for when considering the effects of DC cables. The DC magnetic field from cables running perpendicular to magnetic north will affect the intensity and inclination angle of the geomagnetic field, but not the declination angle. In contrast, the DC magnetic field from cables running parallel to magnetic north will affect the declination angle of the geomagnetic field as well as its intensity and inclination angle. As an example, the expected magnetic field from the proposed NaiKun 200 kV cable was modeled with and without the influence of the local geomagnetic field. In this case, the combined

Table ES-2.

DC magnetic fields (μT) reflecting averaged values from 8 projects at intervals above and horizontally along the seabed assuming 1m burial.

Distance (m) Above Seabed	Magnetic Field Strength (μT)		
	Horizontal Distance (m) from Cable		
	0	4	10
0	78.27	5.97	1.02
5	2.73	1.92	0.75
10	0.83	0.74	0.46

magnetic field would be about 30 percent lower than modeling that does not account for the geomagnetic field would suggest because the magnetic field from the proposed cable is oriented opposite to that of the geomagnetic field.

Movement through a magnetic field or the rotation of a magnetic field creates induced electric fields. This can occur from water current movement or from an organism swimming through the field or from the asymmetric rotation of the AC field within the industry standard 3-phase cable. The speed and orientation of the current or the organism relative to the field determine the strength of the induced field. A water current or organism moving parallel to the cable magnetic field will not generate an induced electric field. A water current or organism moving perpendicular to the cable magnetic field will generate the maximum induced electric field and that field strength will be a function of the current's or organism's speed, its exact orientation relative to the cable magnetic field, and the strength of the magnetic field. The induced electric field strength generated by a 5 knot current running perpendicular to a DC cable is shown in Table ES-3. While magnetic fields from AC cables can also induce electric currents, the polarity of the induced current would reverse at the same frequency as that of the AC magnetic field, potentially reducing the likelihood that the induced field from AC rotation would be detectable by organisms if they were not sensitive to electric fields at this frequency.

Table ES-3.

Modeled average induced electric field from DC submarine cables (V/m) at distances above seabed and horizontally along seabed for cables buried 1m below seabed for a 5 knot current.

1	Electric Field Strength (V/m)		
	Horizontal Distance (m) from Cable		
	0	4	10
0	1.94×10^{-4}	3.15×10^{-5}	7.85×10^{-5}
5	1.75×10^{-5}	1.62×10^{-5}	1.39×10^{-5}
10	8.80×10^{-6}	8.52×10^{-6}	7.13×10^{-6}

MAGNETOSENSITIVE AND ELECTROSENSITIVE MARINE SPECIES

Magnetic or electric senses have been reported for a wide range of marine taxa (Tables ES-4 and ES-5). Evidence of a magnetic sense is available for marine mammals, sea turtles, many groups of fishes (including elasmobranchs), and for several invertebrate groups. The ability to detect electric fields is well known for elasmobranch fishes and the widespread occurrence of the anatomical structures (ampullae of Lorenzini) suggests that it is a virtually universal ability within the group. Ratfishes, some groups of bony fishes (lampreys and sturgeons), and a few teleosts also have a highly advanced electrosensory system, although most teleosts (the largest group of bony fishes) do not. Few invertebrates have ever been tested for an electric sense, though some recent evidence has been reported in decapod crustaceans (crabs, shrimp, and lobsters). Notwithstanding the behavioral, physiological, and anatomical evidence of EMF detection capabilities for many species, data gaps remain in the understanding these capabilities.

Table ES-4.

Electro- (E) and magnetosensitivity (M) in marine fish – summary of knowledge.

Species	Species Groups	Type of Sensitivity (No. of studies)	Evidence Basis ^a	Life Functions Potentially Affected
Elasmobranchs	Dogfish	None (1)	B	None?
	Nurse sharks	E (1)	B	Feeding, predator or conspecific detection
	Mackerel sharks	E/M? (2)	B, A	Feeding, predator or conspecific detection, navigation
	Cat sharks	E (4)	B, P	Feeding, predator or conspecific detection
	Hound sharks	E (3)	B	
	Requiem sharks	E (4)	B	
		E/M? (1)	B, A	Feeding, predator or conspecific detection, navigation
		None (1)	B	None?
	Hammerhead sharks	E/M (1)	B, A	Feeding, predator or conspecific detection, navigation
		E (1)	B, A	Feeding, predator or conspecific detection
	Torpedo rays	E (1)	B	
	Thornback rays	E (1)	P	
	Skates	E (4)	A, T, P	Feeding, predator or conspecific detection
		E/M? (2)	B, A	Feeding, predator or conspecific detection, navigation
	Stingrays	E (4)	B, T	Feeding, predator or conspecific detection
		E/M (1)	B, P	Feeding, predator or conspecific detection, navigation
M? (1)		T	Navigation	
Other Fishes	Lampreys	E (3)	P	Feeding, predator or conspecific detection
	Ratfishes	E (1)	P	
	Sturgeons	E (2)	B, P	
		E/M (1)	B	Feeding, predator or conspecific detection, navigation
	Eels	E/M (2)	P, B, A	
		M (1)	P	Navigation
	Sea catfishes	E (1)	P, A	Feeding, predator or conspecific detection
	Salmonids	M (5)	B, A	Navigation
		M/E? (1)	P, B, A	Navigation, feeding, predator or conspecific detection
	Cods	E (1)	B	Feeding, predator or conspecific detection
	Scorpionfishes	M (1)	P	Navigation
	Grunts	M? (1)	B	
	Mackerels	M (1)	B, A	
	Righteye flounders	None (1)	No toxicity (M)	
M? (1)		B	Navigation	

^a B=behavioral, A=anatomical, P=physiological, T=theoretical; refer to Tables 4.2-1 and 4.2-3 for details

Table ES-5.

Electro- (E) and magnetosensitivity (M) in marine mammals, sea turtles, and invertebrates – summary of knowledge.

Species	Species Groups	Type of Sensitivity (No. of studies)	Evidence Basis ^a	Life Functions Potentially Affected
Marine Mammals	Baleen whales	M (2)	T	Navigation
	Toothed whales	M (13)	T, B, A	Navigation
		None (3)	T	None
Sea Turtles		M (4)	B, T	Navigation
Invertebrates				
Mollusks	Snails	M(1)	B	Orientation
	Bivalves	None (1)	No toxicity (M)	
		M (1)	P	Uncertain
Arthropods	Isopod	None (1)	No toxicity (M)	
		M (1)	B	Orientation
	Amphipod	M(1)	B	Orientation
	Shrimp	None (1)	No toxicity (M)	
	Lobster	None (1)	P	
	Crayfish	M (1)	P	Orientation
		E (2)	B	Feeding, predator detection,
	Spiny lobster	M (1)	B, A	Navigation
Crab	None (1)	No toxicity (M)		
Echinoderms	Sea urchin	M (2)	P, embryonic development	Reproduction

^a B=behavioral, A=anatomical, P=physiological, T=theoretical; refer to Tables 4.2-7, 4.2-13 and 4.2-17 for details

Many fundamental questions about sensory system mechanisms and life functions supported by these senses have not been resolved. Just a small fraction of marine species have been directly studied for magnetic or electric senses. Even for studied species, work has often focused on a particular life history stage, such that sensory capabilities for certain stages (e.g., larval fish and invertebrates) are unknown. Research has also focused on natural behaviors and interactions, and studies that evaluate response to EMFs from power cables are almost entirely absent from the literature. A handful of studies have examined responses of marine species to EMFs from undersea power cables; some suggest a response (e.g., Gill et al. 2009, Westerberg 2000) while other do not (e.g., Andruliewicz et al. 2003). Nonetheless, even with some examples of responses, the question of any positive or negative consequences at the individual, population, or system levels has not yet been addressed. Hence, data gaps in the fundamental biology (i.e., sensory biology, behavioral biology, ecology) of marine species and in the specific question of response to anthropogenic EMFs make conclusions about potential impacts highly speculative.

Despite these uncertainties, available information allows for some inferences to be made about potential EMF effects. Life functions supported by a magnetic sense may include orientation,

homing, and navigation to assist with long or short-range migrations or movements. Life functions supported by an electric sense may include the detection of prey, predators, or conspecifics to assist with feeding, predator avoidance, and social or reproductive behaviors. A risk of interference with these functions exists in areas surrounding cables where sensory capabilities overlap with cable EMF levels detectable by the organism.

Comparisons of modeling results to sensory capabilities demonstrate clear differences between likely responses of sensitive species to EMFs from AC versus DC cables. Research suggests that marine species may be more likely to detect and react to magnetic fields from DC cables than AC cables. It is unclear, however, whether this applies equally to electrosensitive species. Induced AC electric fields might be relevant if electrosensitive species are shown to be sensitive to fields in the range of 50-60 Hz and higher frequencies.

Most marine species may not sense very low intensity electric or magnetic fields at AC power transmission frequencies (i.e., 60 Hz in US). AC magnetic fields at intensities below 5 μ T may not be sensed by magnetite-based systems (e.g., mammals, turtles, fish, invertebrates), although this AC threshold is theoretical and remains to be confirmed experimentally. Low intensity AC electric fields induced by power cables may not be sensed directly at distances of more than a few meters by the low-frequency-sensitive ampullary systems of electrosensitive fishes. If these generalities for AC magnetic and electric fields hold across the many taxa and lifestages that have not been investigated, then this limits the area around AC cables in which sensitive species would detect and therefore possibly respond to EMFs. However, AC electric fields associated with power cables may still evoke responses of individuals and affect populations most closely associated with the benthic habitat, especially in very close proximity to cables. More specific research is required to determine this.

The intensity of modeled magnetic fields around DC cables is higher than fields around AC cables of similar voltages, and magnetosensitive organisms are likely equipped to detect low intensity (<10 nT [$<0.01 \mu$ T]) DC magnetic fields, well below the levels predicted for the cables examined (Figure ES-2). The question has arisen as to whether the alteration in the magnetic field around a DC cable may interfere with orientation or navigation by magnetoreceptive species. DC electric fields are also generated by the flow of charged ions (e.g., seawater, a moving organism) moving through a DC magnetic field. Electrosensitive fish are highly sensitive to DC electric field gradients as low as 5 nV/cm as they swim through them. The bioelectric fields that are produced by living organisms are primarily DC fields produced by ion gradients within the organism (although AC fields are also generated). Although induced electric fields from undersea cables may not directly mimic bioelectric prey, conspecifics, or predators, these resultant fields may affect the behavior of electrosensitive species.

One representative species from each phylogenetic group was presented as a case study for assessing the potential for impacts from exposure to power cable EMFs. Each species was examined in terms of aspects of its natural history that could place individuals in proximity to the field, available knowledge of its (or a related species) sensitivity to either electric or magnetic fields, and behaviors that could be affected. Species selected for review were generally those for which the most information on electro- or magnetosensitivity was available. Results of these assessments are summarized in Table ES-6.

Table ES-6.

Summary of case history impact assessment.

Taxonomic Group: Species	Selection criteria	Life stage of concern	Type of effect possible	Certainty	Implications for taxonomic group
Elasmobranchs: Sandbar shark	HAPC; electrosensitive	Neonates and juveniles; migratory adults and juveniles	Interference with feeding; navigational miscue during migration	Sensory thresholds overlap with predicted field strength but nature of response not field tested	Behavioral response to power cables possible in species occurring in near-bottom waters
Other fishes: Sockeye salmon	ESA-listed species; reproductive migrant; magnetosensitive	Spawning migrants	Navigational miscue	Effect unlikely; pelagic behavior keeps fish away from strongest fields	Limited effect expected for other salmonids with similar spawning behavior
Marine mammals: Bottlenose dolphin	Common coastal species; Magnetosensitive; strandings correlated to geomagnetic minima;	All	Navigational miscue during migration	Effect possible but unlikely to be significant	May expect similar limited effects among other porpoises or dolphins; insufficient information to determine effect on whale species,
Sea turtles: Loggerhead turtle	ESA-listed species; coastal lifestages; magnetosensitive	Hatchlings and reproductive adults	Navigational miscue; interference with feeding	Effect possible in hatchlings; adult navigation uses multiple cues so effect less likely	May expect similar effects among other sea turtle species
Invertebrates: Spiny lobster	Commercially important; magnetosensitive	Adults	Navigational miscue during migration or homing	Sensory threshold overlaps with predicted fields	Effects may be similar in closely related species but evidence very limited for more distantly related arthropods and other invertebrate taxa

Juvenile sandbar sharks return to estuaries or near-coastal waters for several years and this species' dependence on specific Mid-Atlantic estuaries led to the identification of Habitat Areas of Particular Concern (HAPC). Throughout their lives sandbar sharks feed preferentially on benthic invertebrates or demersal fish. The combination of these behaviors and the focus on these waters for offshore wind project development indicate that there is a high likelihood that this species will be exposed to undersea power cables. Experiments with free-swimming sandbar sharks demonstrated their response (orientation) to low electric fields intensities. Although juveniles could be conditioned to detect pulsed DC magnetic fields, the mechanism for this response is unclear; results are suggestive that this species could react to induced electric fields resulting from power cable magnetic fields. Field testing has not been conducted to examine the behavior of sandbar sharks in the vicinity of undersea power cables so extrapolation of available literature to as assessment of impacts can only be speculative. Exposure to electric and magnetic fields generated by power cables could interfere with feeding activities, but modeling has shown that field strengths above apparent sensitivity thresholds are likely to be limited in space. Hence, the severity of the impact could range from negligible (e.g., slight increase in effort expended to feed because of false signals) to moderate (e.g., cable running through a critical juvenile feeding ground and resulting in some lost feeding opportunities). It is expected that other demersal sharks with coastal populations (and particularly with coastal juveniles) would have similar responses to cable exposure.

Sockeye salmon return to their natal rivers to spawn and juveniles remain near the coast for a period before heading to the open ocean for the next two years. Both lifestages rely partially on the geomagnetic field to reach their destinations. Sockeye salmon are pelagic by the time they reach the juvenile stage, descend downstream, and enter the ocean. Although modeling results suggest that magnetic fields emitted by AC cables might be detectable by salmon, the fish would have to be within several meters of the cable to do so; a pelagic lifestyle well above the bottom suggests that exposure is unlikely. Widely-separated DC cables could emit magnetic fields at intensities above the apparent threshold of this species extending well into the water column. If the cable were oriented such that its magnetic field altered the geomagnetic field locally, particularly in the immediate vicinity of an estuary mouth, adults on their spawning migration and juveniles on their exit to the sea could be miscued. As there is evidence that this species relies on multiple senses, including sight and olfactory, during migration, they may be able to compensate for a localized perturbation in the geomagnetic signal. It is expected that other salmonids with similar spawning behavior would experience the same type of effect.

Bottlenose dolphins were selected for case study evaluation because of evidence of its sensitivity to the geomagnetic field, its seasonal north-south migration, its frequent occurrence in coastal waters, and its benthic feeding habits. In the western Atlantic, live strandings of this species have been correlated with geomagnetic minima, apparently responding to variations as low as $<0.05 \mu\text{T}$. By virtue of its habitat preferences and behavior, bottlenose dolphins could be exposed to undersea power cables from offshore wind projects. DC cables would have the greatest potential for affecting this species and modeling suggests that the bottlenose dolphin could detect the field emitted by a DC cable (assuming cable field not influenced by the geomagnetic field) up to 50 m or more directly above the cable. The actual field intensity would, however, be affected by the orientation of the cable to the geomagnetic field. It is conceivable that a dolphin could sense the cable's magnetic field and alter the direction of its movement in

response. Once it was outside the influence of the cable in a matter of meters, it would be likely to correct its orientation. Other dolphins and porpoises might be expected to have similar responses. It is difficult to extrapolate the results to whales.

The geomagnetic sense in loggerhead turtles has been studied fairly extensively including critical early lifestages. This species depends on multiple senses at various stages of its long-distance movements. There are indications that the geomagnetic sense is critical for primary orientation to approach the general vicinity of a destination (e.g., nesting beaches, feeding grounds), but that fine-tuning is accomplished by using olfactory and visual cues. Hatchlings exposed to low intensity pulsed magnetic fields swam randomly compared to control animals that swam easterly. Power cables placed in the immediate vicinity of nesting beaches could affect the ability of hatchlings to swim towards nursery grounds. It is assumed that any of the sea turtle species could be affected the same way.

Spiny lobsters undergo both seasonal migrations and daily feeding excursions. They are sensitive to the earth's magnetic field and use this sense both for navigation and homing. Spiny lobsters are always in contact with the seafloor and would be exposed to the highest magnetic field strength of any power cable they encountered. Sensitivity thresholds have not been determined, but theoretical calculations suggested that a magnetic field emitted by a 60 Hz AC cable would have to be at least 5 μ T to be detectable by the spiny lobster's magnetite-based system, a field strength likely to occur only within several meters of the cable, but within perhaps tens of meters of a DC cable (depending on cable orientation). Exposure to a DC cable could potentially delay or alter migration patterns or interfere with homing capabilities. Other decapods have not been investigated as thoroughly as the spiny lobster. It is reasonable to assume that those that exhibit similar migratory and homing behaviors also possess magnetosensory capabilities and could experience similar effects when exposed to power cables.

These case studies confirm the finding that, while there is a large body of information that demonstrates or implies the use of electro- or magnetosense by many marine species, information that enables a quantifiable impact analysis is limited. On a qualitative basis, the weight of the evidence available suggests that elasmobranchs and sea turtles have the highest likelihood of being affected by exposure to power cable EMFs. Electrosensitivity is widely spread among elasmobranchs and magnetosensitivity is widely spread among sea turtles. The ramifications of exposure of sea turtles at a critical life stage, such as adults and hatchlings traversing shallow waters at natal beaches, are high, although the likelihood of exposure is probably low, assuming careful siting. Consequences of EMF exposure to sharks are unclear, although the likelihood of exposure for at least some individuals of coastal demersal species is relatively high given the broad distribution of these species. Marine mammals have a relatively low likelihood of being affected by power cable EMFs despite being magnetosensitive because their high mobility would limit the duration of exposure. Populations of some species of decapod crustaceans (e.g., lobsters, crabs) could experience a moderate level of effects from EMFs as their epibenthic habitat and relatively low mobility would expose individual organisms to the highest field strengths. Although electro- or magnetosense has been demonstrated in a number of pelagic fish species (non-elasmobranchs), this habitat preference generally places them outside the greatest field strengths from undersea cables. Demonstration of electro- or magnetosensitivity in demersal fish (other than elasmobranchs) is extremely limited and provides

no basis for inferring a level of impact although these species have the potential to be exposed to the highest field strengths.

DATA GAPS AND RESEARCH PRIORITIES

Regulatory agencies should require that details of the cable design, anticipated cable depth and layout, magnetic permeability of the cable sheathing, and loading (amperes) be provided early in the permitting process to allow complete determination of EMF potentially generated by the cable. Complete information is available only for a few projects. Field measurements of magnetic fields in the vicinity of operating power cables, correlated with data on current flow, would be useful to validate model results, but also to make more informed assessments of potential effects on marine organisms. Development of sensors capable of detecting AC or DC electric fields in the marine environment would be valuable to confirm that burial and sheathing are preventing emission of electric fields into the water column.

As shown in Tables ES-4 and ES-5, investigations into electro- or magnetosensory capabilities have been conducted for only a few marine species. While knowledge of the sensory biology of a few species within a phylogenetic group can be cautiously extrapolated to other related species, responses to anthropogenic sources of electric or magnetic fields have not been well studied. To facilitate impact analysis, future research should focus on behavioral responses to exposure to power cables at which field strengths are known. Organisms of interest for this type of research include elasmobranchs, sea turtles, and decapod crustaceans.

MITIGATION AND MONITORING

Numerous marine organisms are capable of detecting electric and magnetic fields and many species use their electrosense or magnetosense in important life functions such as prey detection or navigation. It has not yet been determined, however, whether exposure to electromagnetic fields from anthropogenic sources has the potential to have deleterious effects at the individual, let alone the population levels. Thus, it is premature to fully define how much mitigation is absolutely necessary.

Regardless, there are several engineering solutions that can be considered to reduce EMF emissions. As some of these simultaneously provide protection for the cable, incorporation into the project design can be done without significant additional cost implications, often an impediment to achieving developer buy-in for mitigation. Design considerations include current flow, cable configuration, and sheath/armoring characteristics. Cable design and voltage are the factors that are likely to have the greatest effect on magnetic field generation. AC cables appear to generate lower magnetic field strengths than DC cables for about the same voltage. Higher voltage cables produce lower magnetic fields than lower voltage cables for the same power delivered. Magnetic fields from can be minimized by placing the cables close together allowing the field vectors from each cable to cancel each other out. Sheathing the cable and increasing the conductivity and permeability of the sheaths also reduce the magnetic field.

Methods to increase the distance from the cable to the overlying water body can further reduce the magnetic field, but may trigger unacceptable secondary effects, depending on the specific site

conditions. The amount of seafloor disturbance is proportional to the burial depth. While this is generally considered to be a temporary effect, the magnitude of this type of impact is dependent on sediment characteristics and proximity to resources sensitive to increased sedimentation. Placing concrete mattresses or other cover material over the cable would also increase the distance to the water column. These materials would constitute a change in habitat conditions, however.

Orientation of a DC cable relative to the local geomagnetic field determines the magnitude of the combined field. The most direct route from the project to landfall is usually considered to be the most desirable alternative and results in the least seabed disturbance. In areas where particularly sensitive resources are located near shore, however, a greater amount of temporary disturbance may be an acceptable trade-off to minimize the potential for localized changes in the magnetic field.

Consideration must be given to the specific resources occurring in the area proposed for the power cables during project planning to develop species-specific mitigation if necessary. Avoidance is the best mitigative action and it is strongly suggested that siting of power cables in the vicinity of sea turtle nesting beaches be avoided until additional research determines whether these cables pose a risk to these species. In addition, NMFS has designated Habitat Areas of Particular Concern (HAPC) for the sandbar shark in certain coastal waters and bays from New Jersey to North Carolina. Again, it is strongly suggested that projects offshore of these states site their power cables outside the boundaries of the HAPC if other sites are available.

Monitoring of mitigation actions is best directed towards measurement of the actual electric and magnetic fields once a cable is powered. These results can be used to validate modeling done during the permitting stage and will be useful in determining the actual effectiveness of the mitigation. In cases where a project has been designed specifically to avoid exposure of a particular species to EMF, pre- and post-construction monitoring should be undertaken to demonstrate that the project area does not provide important habitat for this species.

CUMULATIVE IMPACTS

This study examined the potential effects of the exposure of marine organisms to multiple power cables. Most offshore renewable energy projects are likely to be installed near areas of human population density and the present focus for offshore wind projects is along the Atlantic coast from Virginia to Maine. Several projects are under development in southern New Jersey and Delaware so there is the potential for several export cables, as well as interconnecting cables, in a small geographic area.

Behavioral response to EMFs and the significance of that response at the population level is not yet understood. Extrapolating from a single exposure to multiple exposures can only be speculative at this time. It is presently believed that marine organisms can be roughly divided into three behavioral groups for the purposes of this type of analysis: coastal migrants, onshore-offshore migrants, and resident species (or lifestages).

Coastal migrants have the potential to cross more than one export cable (and possible interconnecting cables) during their seasonal north-south migrations. The likelihood of their being exposed to EMFs is a function of their typical behavior in the vicinity of each cable. Species that travel near the seafloor and species feed on or near the bottom would have greater exposure than those swimming or feeding higher in the water column. Potential risks from multiple exposures could include multiple navigational miscues (assuming these are not corrected by the use of other senses) or interference with feeding.

Onshore-offshore migrants include species that move between shallow and deep waters annually and species that perform these movements for the purposes of reproduction. Individuals could, in this manner, be exposed to one or more cables multiple times over their lifetimes. The orientation of the cable to their migratory route and the location of the offshore migratory endpoint would determine the actual duration of their exposure. It is not clear, however, whether infrequent, but repeated exposure would have a cumulative effect on these species.

Sessile or weakly motile species and species in which different lifestages occupy distinct habitat areas are considered to be residents. Of the greatest potential concern, in terms of cumulative impacts, are those species whose early lifestages could experience repeated exposure to the same cable or cable array although changes in sensitivity to EMFs over lifestages is not understood.

CONCLUSIONS

This synthesis of available data and information clearly demonstrates that more work is needed to understand the nature and magnitude of any potential impacts to marine species from undersea power cable EMFs. Nonetheless, EMF modeling results in this report provide a general reference for understanding the magnitude and characteristics of magnetic and induced electric fields from undersea cables. The listing of priority species for US waters provides a focused list of species with magneto- or electrosensory capabilities. The analyses of potential impacts and compilation of data gaps and research priorities provide direction to guide further efforts to address the question of effects from power cable EMFs on marine species.

Conclusions that can be drawn from the information gathered in this report include:

- Anticipated EMFs from power cables can be modeled easily as long as specific information is available:
 - Cable design
 - Burial depth and layout
 - Magnetic permeability of the sheathing
 - Loading (amperes)
- Modeling of DC cables must take local geomagnetic field into account to accurately predict field strength.
- Voltages of interconnection cables are lower than on export cables resulting in lower magnetic fields than from within-array cabling.
- Species with electrosensitivity are likely to be able to detect EMFs from both DC and AC cables with high sensitivity to DC cables. Taxa include:
 - Elasmobranchs

- Some teleost fish
 - Some decapod crustaceans
- Species with magnetosensitivity are more likely to be able to detect EMFs from DC cables than from AC cables. Taxa include:
 - Sea turtles
 - Some marine mammals
 - Some decapod crustaceans
- Electrosense is well documented among elasmobranchs so knowledge about the effects of exposure to EMFs on one species can be cautiously applied to another species with similar behavioral patterns (e.g., preferred position in the water column, prey items, habitat preferences).
- Behavioral responses to electro- or magnetic fields are known for some species but extrapolation to impacts resulting from exposure to undersea power cables is speculative.
- Demersal species (some elasmobranchs, other fish species, or decapod crustaceans) are more likely to be exposed to higher field strengths than pelagic species.
- Despite the fact that the available biological information allows only a preliminary level of impact assessment, modeling indicates that the electromagnetic fields emitted by undersea power cables are limited spatially (both vertically and horizontally). This spatial limitation must be considered in any impact assessment as it reduces the risk that any given organism will be exposed.

1. INTRODUCTION

Growing demand for clean domestic power sources has fueled an interest in offshore renewable energy technologies. Commercial development of these technologies is new to US waters, and the Energy Policy Act of 2005 authorized the Department of the Interior (DOI), after consultation with other federal agencies, to grant leases, easements, or rights-of-way for various energy-related activities on the Outer Continental Shelf (OCS), including renewable energy projects. In 2006, DOI designated the Bureau of Ocean Energy Management, Regulation and Enforcement (BOEMRE; then known as Minerals Management Service) as the agency responsible for implementing these provisions. BOEMRE has established a Renewable Energy and Alternate Use Program for the administration of these responsibilities. BOEMRE's responsibilities cover management of activities that "(1) produce or support production, transportation, or transmission of energy from sources other than oil and gas, or (2) use, for energy-related or other authorized marine-related purposes, facilities currently or previously used for activities under the OCS Lands Act" (BOEMRE 2009). Under the original intent of this Act, DOI was responsible for management of all alternative energy-related uses of the OCS, but through a Memorandum of Understanding in April 2009, DOI and FERC (Federal Energy Regulatory Commission) agreed that FERC would have the responsibility for the licensing of wave and ocean current (hydrokinetic) projects on the OCS with BOEMRE retaining the jurisdiction for issuing leases, easements, and rights-of-way for these projects as well as management of all non-hydrokinetic projects. BOEMRE has the primary responsibility for NEPA review of non-hydrokinetic projects and the opportunity to act as a cooperating agency for NEPA review of hydrokinetic projects on the OCS. As all power-generating projects require intra-array and export transmission cables, BOEMRE is responsible for understanding the potential impacts associated with power transmission from any of these projects before a lease can be granted.

The BOEMRE has a long history of overseeing commercial activities on the OCS related to its leasing responsibilities for offshore oil, natural gas, and sand and gravel. In 1973 the BOEMRE established its Environmental Studies Program (ESP) which has developed the scientific knowledge necessary to support environmentally responsible decision-making. With BOEMRE's expanded authority has come the need for further investigations related to biological resources on the OCS. Offshore renewable energy development poses potential environmental impacts that are not fully understood, and the BOEMRE is gathering scientific data and information to support detailed environmental analyses regarding such impacts. One potential source of impact, common to all offshore renewable energy technologies, comes from interarray cabling as well as the transmission of power to shore. Undersea power transmission cables generate electromagnetic fields (EMFs) that may impact marine organisms. Information on the magnitude and environmental effects of EMFs is widely scattered throughout the peer-reviewed and "gray" literature. In this era when many marine species have been found to be under increased stresses, the need for adding hundreds, if not thousands, of miles of submarine transmission lines makes it imperative that the regulators and developers have a comprehensive understanding of issues related to EMFs.

This document provides a compilation of relevant literature (through 2009) that can be used in the licensing process to assess EMF effects on individual projects within the BOEMRE planning

areas of the contiguous states and Alaska (Figure 1.0-1) in order to meet two primary study objectives:

- Characterization and quantification of EM fields produced or predicted to be produced by underwater transmission cables associated with offshore renewable energy projects;
- An understanding of which marine species occurring in the study area may be sensitive to either electric or magnetic fields, the physiological basis for those sensitivities, life history and behavioral characteristics that may affect potential for exposure, and potential effects of exposure to EMFs from offshore renewable energy projects.

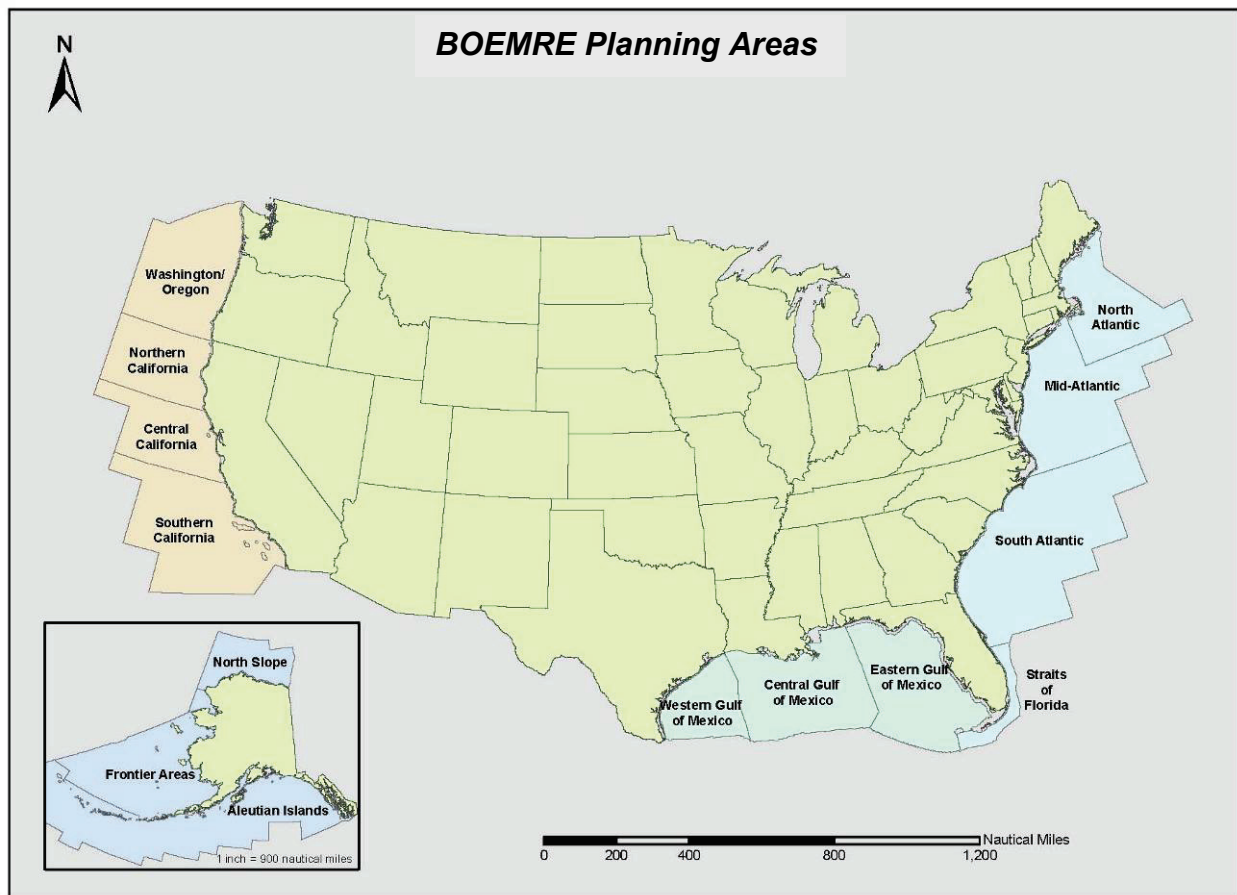

Figure 1.0-1 US Department of the Interior, Bureau of Ocean Energy Management, Regulation and Enforcement (BOEMRE) offshore administrative boundaries on the Outer Continental Shelf in the Alaska, Atlantic, Gulf of Mexico, and Pacific Regions encompassed in this study. Planning areas in Alaska have been grouped into three regions.

1.1 NEPA PROCESS

BOEMRE has developed a regulatory pathway for offshore wind projects that includes NEPA analysis at one or more junctures, depending on how the project unfolds. Evaluation of EMF effects would likely occur either at the lease sale stage (in the case of competitive interest for a particular area) or at the stage when a commercial license is sought (either a noncompetitive situation or by the successful bidder on a competitive lease sale) because both of these phases would need to consider the effects of operation. EMF issues are associated only with the conductance of electricity through transmission cables either interconnecting individual units or connecting the project to the grid. Thus, this issue does not need to be considered for the data gathering phase (e.g., meteorological tower or current meter installation to determine site conditions) covered by the Site Assessment Plan (SAP).

1.2 TYPES OF ELECTROMAGNETIC FIELDS

There are naturally occurring electromagnetic fields and those of anthropogenic origin. At frequencies associated with power cables, the coupling of electric and magnetic fields described by Maxwell's equations (the four equations that relate the electric and magnetic fields to their sources, charge density and current density) is very weak so these field components are treated separately. The most well known and dominant is the earth's static magnetic field (geomagnetic field) that is present in all environments whether terrestrial or aquatic. The geomagnetic field varies across the globe from around 30 to 70 microtesla (μT) and is roughly 50 μT in the US. It is used by a number of species for orientation or navigation through the environment over large and small spatial scales (Kirshvink 1997). Natural magnetic fields are also associated with geologic movements, such as tectonic plates shifting, but these are very variable in their extent, duration and occurrence. The earth's atmosphere can also create magnetic variation within the earth's surface waters through lightning and interactions with the magnetosphere.

The movement of sea water through such magnetic fields creates localized electric fields. These can be persistent and predictable in terms of tidal streams and can occur in the shallow waters during tidal ebb and flow. The electrical fields are relatively small (on the order of 0.05-0.5 $\mu\text{V}/\text{cm}$, Kalmijn 1971). Electric fields are also directly produced by all living organisms. The beating of a heart, the nerve impulses within an organism or ionic exchange sets up a variety of AC and DC electric fields of biological origin, these are known collectively as 'bioelectric fields.' It is these fields that are used by some organisms to find each other or to locate prey items that they are hunting. In addition, mobile organisms experience electric fields induced by their movement in the sea through the earth's geomagnetic field. Such fields are implicated in the navigation and orientation of some fish species (Klimley 1993).

In terms of anthropogenic EMFs there are a number of potential sources. Most are linked to undersea cables used for power generation and telecommunications or submarine communications. Other sources include pipelines that are electrically heated, antifouling techniques and other electrolysis based sources (Kullnick 2000).

The focus of this review is the undersea cabling associated with offshore renewable energy. These cables can produce exposures to EMF in three ways: the electric field produced by the

voltage applied to the cables, the magnetic field produced by current flow on the cable, and an indirect AC electric field induced by alternating magnetic fields from the cables or movement through a DC field of the earth or cables. The electric field from the cable is not an important source of potential exposure as in almost all instances the energized conductor of a cable is surrounded by grounded metallic sheaths and armoring that shield the marine environment from the electric field from the cable. The magnetic field is only minimally attenuated by the cable wrappings or the overlying seabed and so the magnetic field from the cable will perturb the ambient geomagnetic field in the vicinity of the cable. The alternating magnetic field of a cable can, in addition, induce electric fields in nearby objects. As described in this report, there are varying types of evidence to indicate that a subset of marine organisms can detect EMF within the range of frequencies associated with the operation of AC and DC power cables.

There is very little current understanding of if or how organisms will be affected by changes in environmental levels of EMF. Questions have been raised as to whether migratory species may deviate from their intended routes with subsequent potential problems for populations if they do not reach essential feeding, spawning or nursery grounds. On a more local scale, the question of whether species that use EMF for finding food may be confused and spend time hunting EMF that is non-biological and hence reducing daily food/energy intake has been raised. The consequence might be that if enough individuals are affected or a significant proportion of their activity is altered then the population and communities of which these species are a part may be adversely affected. The present study evaluates the level of certainty with which we can address such questions based on the current state of the science.

As is described in detail in Section 4.1, configuration and characteristics of the cabling for an offshore wind project are project-specific. Local wind characteristics, seabed characteristics, turbine size, distance from the shoreline, and shoreline configuration are among the factors that will determine the optimal layout of a wind project. Most projects have been proposed with AC interconnecting cables within the turbine array, but the cable to the grid may be either AC or DC. Existing and proposed projects have cables to the shore that are bundled or laid in parallel either in close proximity or with some distance between the cables. Each configuration presents unique characteristics to the electric and magnetic fields they generate during operation and so must be evaluated individually.

1.3 EUROPEAN PERSPECTIVE

Europe has led the world in harnessing offshore wind resources with the first project becoming operational in 1991. By the end of 2010, there were 45 operational offshore wind projects in Europe (Table 1.0-1) and an additional 1,000 to 1,500 MW of new capacity are expected to be connected to the grid by the end of 2011 (EWEA 2011a). Currently ten offshore wind projects (3,000 MW capacity) are under construction and projects totaling 19,000 MW in capacity are permitted. Several European countries (UK, Germany, Denmark, Belgium, and the Netherlands) have identified specific areas for development of offshore wind projects (EWEA 2009).

Table 1.0-1.

Capacity of operational offshore wind projects in Europe at the end of 2010.

Country	No. of Projects	Capacity (MW)	No. of Turbines
Belgium	2	195	61
Denmark	12	853.7	400
Finland	2	26.3	9
Germany	5	92	19
Ireland	1	25.2	7
Netherlands	4	246.8	128
Norway	1	2.3	1
Sweden	5	183.7	75
United Kingdom	13	1,341.2	436
Total	45	2,946.2	1,136

Source: EWEA (2011b).

Existing offshore wind projects all have both intra-array cabling and export cabling to shore. In addition, there are presently 11 offshore grids operating internationally and seven more international cables are under construction or through the planning stages, mostly in the North and Baltic Seas (EWEA 2009). The European Network of Transmission System Operators for Electricity (ENTSOE) has a ten-year master plan describing a cooperative international grid (HVDC) servicing the 1600 MW of future wind capacity proposed for the German, Swedish, and Danish portions of Kriegers Flak in the Baltic Sea (ENTSOE 2010). ENTSOE also developed a roadmap for advancing a North Sea offshore grid and in December 2010, ministers from North Sea countries signed a memorandum of understanding committing the North Seas Countries' Offshore Grid Initiative (NSCOGI) to advance their understanding of policies and issues related to grid configuration and integration, market and regulatory issues, and planning and authorization procedures necessary to develop this international transmission grid (NSCOGI 2010).

Agencies responsible for environmental stewardship in European countries developing offshore wind facilities have long acknowledged that the cabling increases electromagnetic field emissions in the aquatic environment, but little research has focused on addressing this issue directly. COWRIE (Collaborative Offshore Wind Research into the Environment) has sponsored several studies on EMF, including,

- a baseline assessment of electromagnetic fields that included modeling and direct field measurements at a 33kV and an 11kV cable at Rhyl, North Wales and evaluated mitigative potential of cable shielding permeability, conductivity of cable shield, and cable burial depth (CMACS 2003);
- a literature review of potential effects of electromagnetic fields emitted by offshore wind project cabling on marine organisms (Gill, et al. 2005); and,
- a field study exposing caged fish to powered and unpowered undersea cables to investigate their responses (Gill, et al. 2009). Another aspect of this project was

the *in situ* measurements of EMF associated with cables to shore from two operation wind farms in Liverpool Bay, UK.

Scottish Natural Heritage also sponsored a literature survey specifically reviewing potential effects of EMF on Atlantic salmon (*Salmo salar*), sea trout (*Salmo trutta*) and European eel (*Anguilla anguilla*; Gill and Bartlett 2010).

Evaluation of potential effects of EMF on marine organisms is a required component of the permitting process for projects in the UK and has also been addressed during project planning in other European nations. The limited understanding of the magnitude of the EMF *in-situ* and potential effects on marine species has led to license requirements to conduct monitoring during operation for at least several projects in Denmark and the UK.

Cabling at Nysted, DK consists of 33kV interconnecting lines within the turbine array with a 132kV line to shore. Fish abundances were monitored in the vicinity of the 132kV cable for the two years following the onset of operation (2003-2004) to determine whether the cable hindered migration and whether any species were attracted or repelled by the cable; results were summarized in DONG and Vattenhall (2006). Distribution of four species (Baltic herring [*Clupea harengus membras*], common eel [*A. anguilla*], Atlantic cod [*Gadus morhua*], and flounder [*Platichthys flesus*]) was significantly different between the east and west sides of the cable and the authors attributed this to partial impairment of migration. Common eels appeared to depart the area when they encountered the cable whereas Atlantic cod appeared to accumulate close to the cable. Only the distribution of flounder appeared to be correlated to EMF strength (as estimated by power production) and flounder were most likely to cross the cable during periods of low power production. DONG and Vattenhall (2006) were cautious about the interpretation of these results, however, and suggested that incomplete restoration of the seafloor to baseline conditions could have been a factor influencing fish behavior.

License conditions for five operating offshore wind projects in the UK (Barrow, Burbo Bank, Kentish Flats, North Hoyle, and Scroby Sands) have required monitoring of fish distribution inside and outside the turbine array (Walker and Judd 2010). The primary purpose was to understand whether the turbines were acting as attractants, but for projects where electro-sensitive species were identified during the environmental review process (North Hoyle and Barrow), Walker and Judd (2010) reported that the license also includes this requirement:

“ Electromagnetic Fields

The Licence Holder must provide the Licensing Authority with information on attenuation of field strengths associated with the cables, shielding and burial described in the Method Statement and relate these to data from the Rødsand [i.e. Nysted] windfarm studies in Denmark and any outputs from the COWRIE sponsored studies in the UK. This is to provide reassurance that the cable shielding and burial depth(s), given the sediment type at the North Hoyle (Barrow) site is sufficient to ensure that the electromagnetic field generated is negligible. Should this study show that the field strengths associated with the cables are sufficient to have a potentially detrimental effect on electrosensitive species, further biological monitoring may be required to further investigate the effect.”

Walker and Judd (2010) concluded that this condition was met for North Hoyle because no elasmobranch species were observed during monitoring. Thornback rays (*Raja clavata*) and lesser spotted dogfish (*Scyliorhinus canicula*) were common during monitoring at Barrow (NIRAS 2009), so the concern for potential effects of EMF was not abated by simple fish sampling. No site-specific measurements of EMF were made, but NIRAS drew upon the results of the COWRIE-sponsored field measurements of EMF emitted by wind project cables at Burbo Bank and North Hoyle to assess the likelihood of impacts. Measurements at Burbo Bank and North Hoyle, which had similar sediment structure and cable characteristics to Barrow, indicated that at full power the maximum induced electric field would be below a threshold of concern (100 $\mu\text{V/m}$) and NIRAS concluded, therefore, that further monitoring to evaluate this concern was not necessary.

A COWRIE-sponsored mesocosm study was designed to examine behavior of electro-sensitive species confined in the vicinity of powered and unpowered buried cables in Scotland (Gill, et al. 2009). This unique study showed that the two species of benthic elasmobranchs studied, did respond by being attracted to the EMF emitted, albeit with high variability among individual fish. While demonstrating a response to this exposure, however, the results do not allow an assessment of the impact on the fish or fish populations. Other direct evidence of response to powered cables is limited. It has been inferred that, at times, the European eel can detect and respond to the magnetic component of the EMF being emitted by 132-kV AC cables (Westerberg and Lagenfelt 2008) or a monopole DC submarine cable (Westerberg 2000). Other reports have generally been anecdotal (see Gill, et al. 2005) but the implications of such responses at the population level have not been determined.

While the understanding remains poor, European regulators have taken actions to consider the potential impacts of EMF to marine resources. As a result, European wind farm operations are required to include investigations targeting this issue within their wider environmental monitoring as a condition of their operating licenses. In the absence of better information to guide them, regulators require specific collection of fisheries data to take account of the location and route of the cable(s) and, in some case, to monitor EMF levels. There are also calls to work with the wind farm operators to better focus the monitoring to fill the gap in our understanding of EMF (BERR 2008) and use appropriate cabling strategies (i.e., cable types, separation, and burial depths) to minimize potential effects (OSPAR 2008).

In addition to the monitoring requirements, European regulators have provided some general guidelines for mitigation of any potential effects of EMF on organisms. Burial of the cable is suggested as a way to reduce the exposure of organisms to the maximum emitted EMF for projects in the UK by providing a physical barrier (the seabed) between the cable surface and the organism in the water (Department of Energy and Climate Change 2010). This measure reduces the intensity of the magnetic field and induced electric field reaching the water by increasing the distance between the cable and the aquatic environment. The magnetic field is not dampened and is still present in the water where it can induce electric fields either through the electricity transmission within three phase AC cables or the movement of water through the DC field. Other forms of mitigation such as changing the conductivity and/or permeability of the cable materials are, at present, not a requirement. European regulators consider that, at this point in

time, the degree of uncertainty as to the significance of EMF as an environmental impact factor does not justify the expense associated with the manufacturing process and the physical difficulties of constructing sufficient shielding around the cable.

1.4 ORGANIZATION OF THE DOCUMENT

Section 2 of this report describes the methods by which literature research was conducted, information on power cables was analyzed, and how species of interest were identified and prioritized. A summary of the results of the literature survey is provided in Section 3, providing an indication of the depth of information available for each topic of interest. In Section 4, details of each of the research topics are provided.

Results of an extensive literature review that examined characteristics of existing and proposed cables are presented in Section 4.1. Known characteristics of the cables were used to describe “typical” electric and magnetic fields and their vertical and horizontal gradients surrounding the cables. The electric fields induced in organisms by movement in the geomagnetic field or by the presence of alternating magnetic fields from cables were also estimated.

Potential effects on organisms exposed to electric or magnetic fields from undersea power cables are discussed in Section 4.2. For each group of organisms, the evidence of electro- or magneto-sensitivity is presented. This information is examined in the context of the predicted fields as well as the life history and behavioral characteristics of these species to gain an understanding of the potential for exposure. In cases where exposure is possible, the likely responses are presented.

In many cases, evidence of electro- or magneto-sensitivity and the potential effects of exposure to a spatially limited field (relative to the range of mobile species) is suggested but not fully backed up by scientific study. Section 4.3 of this report is devoted to identifying important data gaps towards which research could be directed to further our understanding of this potential impact to marine resources. Mitigation is discussed in Section 4.4. Concerns related to exposure of species to multiple cables are discussed in Section 4.5. Given the limited hard scientific evidence of impacts caused by power cables, the potential for cumulative impacts is difficult to characterize.

Information in the text should be considered as a guide for understanding potential effects of EMFs for specific projects, although each project (or lease sale) should be evaluated based on its specific characteristics. The literature database compiled during this study, and described in Appendix A, is designed to be accessed via key word searches to assist in NEPA analysis of specific projects.

2. METHODS

2.1 LITERATURE SEARCH METHODS

A data collection strategy that employed online commercial databases, literature search tools, Internet search tools, and direct contacts was used to gather data to characterize power cable EMFs and sensitivity of marine species to electric or magnetic fields.

The following commercial databases and search tools were most useful in the search for data on sensitivity of marine species: Web of Science (ISI Science Citation Index), ASFA - Aquatic Sciences and Fisheries Abstracts, Biological Sciences, GeoRef, Google Scholar, Google Books, and WorldCat. A structured literature search was also conducted using PubMed, a search engine provided by the National Library of Medicine and the National Institutes of Health that includes over 15 million up-to-date citations from MEDLINE and other life science journals for biomedical articles dating back to the 1950s (<http://www.pubmed.gov>). The same structured literature search was conducted of Exponent's bibliographic database that includes over 30,000 titles specifically related to electric and magnetic fields, many of which are from journals that are not included in PubMed. In-house libraries at Normandeau and from Drs. Timothy Tricas and Andrew Gill were also utilized.

Key search terms and phrases were used to conduct methodical queries of databases and the Internet. All fields (title, abstract, etc.) were searched for a term that referenced the exposure of interest and the taxa or area of interest. Initially selected key terms and phrases provided a starting point from which a more complete list of terms was developed as the search progressed. Examples of terms and phrases used in the search include: "electromagnetic fields"; EMF; "direct current", "magnetic fields", "electric fields", "electro sensitivity"; "magnetosensitivity"; "impact"; "effect"; "offshore renewable energy"; "impacts from offshore wind power"; "impacts from subsea (or undersea) power cables"; "impact assessment"; "risk assessment", "power lines", "transmission lines", "subsea (or undersea) cables", "submarine power lines". Reference listings from relevant documents were also used to identify important earlier work on the same topic. And more recent papers that cited an original reference of interest were identified using links to these references that are provided within electronic databases. Similarly, focused searches for specific authors who research electro or magnetosensory capabilities in marine species were conducted.

Studies that did not specifically pertain to responses of marine species to electric or magnetic fields at frequencies associated with the operation of power cables were generally excluded. Published, peer-reviewed, English language studies (or those that provided English language abstracts) that are indexed in scientific databases were the primary focus of the review, although relevant books, book chapters, government and industry technical reports, websites, and presentations were also selected for the database. Readers are encouraged to consider that scientific journals have undergone scientific review and therefore may be more reliable than sources that have not been peer-reviewed.

The identification of undersea cables was carried out by means of searches of the files of one of the investigators (W. Bailey) and through internet searches using the exposure search terms

described above. In addition, the reviews of these publications led to the identification of still other relevant publications. The search for undersea cables in U.S. waters included published studies, government reports, industry reports, government and industry websites, and personal contacts. While many more low-voltage AC cables are believed to be installed under harbors, and between islands, these typically are not documented in available records. The exposures to the marine environment from these sources would be similar to those of the low voltage submarine cables from individual wind turbines that are characterized in this report. Cable systems installed or planned in foreign waters, with a focus on those for which measured or calculated electric and magnetic field data were available, were added to the database as examples of cable system designs and technologies that might be proposed for U.S. waters.

2.2 DATABASE METHODS

EndNote™ reference management software was used to develop and manage the project database. Once references were selected by project team members (based on relevance to the project objectives), bibliographic data for the reference was either downloaded directly to the project database or saved (electronically downloaded in a tagged format or manually entered into a template) for later importation. Standard bibliographic data was collected for each reference (e.g., author, date, title, publisher, volume, pages, reference type, etc.). The URL (Uniform Resource Locator; i.e., address on the World Wide Web) was also collected for websites or documents accessed online. Copyright status was reviewed for each reference, and where restrictions allowed, the abstract (if available) and full-text copy (in pdf format) of documents were included in the database. In addition, each reference was reviewed and information for the following customized fields was assembled: original annotation, keywords, and geographic location. These customized fields are described here:

2.2.1 Original Annotation

An original annotation (250 words or less) was written for each reference to summarize its relevance to the study objectives.

2.2.2 Keywords

Controlled keywords were used to identify categories of references in a hierarchical fashion to allow organization and searching of the database. Two primary controlled keywords, “Power cables” and “E/M sensitive species,” were used to separate references specific to power cables (physics/engineering) from the biology references. Nonetheless; if a reference applied both to “Power cables” and to “E/M sensitive species,” then both terms were listed. To further organize the database within subsections, additional controlled keywords were used. For example, within the category “E/M sensitive species,” the terms “electrosensitivity,” “magnetsensitivity,” and “natural history” were used to identify these topics. For references that reported species-specific research results, the common and scientific names of studied species were included in the key words. In addition to the controlled keywords, other appropriate keywords to describe each reference were listed.

2.2.3 Geographic Location

Geographic location was provided for a reference if the information was available and relevant. This information was provided to allow searching and organization of the database by location. Several hierarchical levels of information, from general region to specific location, were typically provided. For references associated with US waters, the top level identifier was “US,” followed by the following regional identifiers: Atlantic, Gulf of Mexico, Pacific. The BOEMRE planning areas (Figure 1.0-1) were used to identify more specific areas within a region. Regions of Alaska were used instead of identifying the specific planning areas in the waters off Alaska. Within each planning area more specific location information was provided as available or appropriate (e.g., “Cape Hatteras, NC”). Regions outside US waters should be first identified using the region of the world (Europe, Asia, Oceania, Americas, Africa, Polar), then by country, then with more specific location information as available and appropriate.

Subject categories were used to organize the references using custom groups within the database. The keywords and geographic location further categorize the references for sorting and searching. Built-in sorting and search capabilities in EndNote™ software enable users to create customized reference categories for data output.

2.3 POWER CABLE MODELING APPROACH

Documents that discussed undersea power cables were reviewed to determine whether measurements (existing cables) or modeling (existing and proposed cables) of electric fields or magnetic fields were provided. These data were almost always found to be incomplete and limited. Therefore, the magnetic fields of typical AC and DC cable configurations were modeled to better describe the intensity and spatial extent of the magnetic fields from existing and proposed cable systems. Modeling of the DC magnetic field did not take into account the geomagnetic field, i.e., the natural magnetic field of the Earth, with the exception of one project that was used to illustrate the effect of including the geomagnetic field (NaiKun Wind Energy). The geomagnetic field is different at different locations and can add or subtract from the field caused by the cables, depending on the orientation of the field with respect to the undersea cables.

2.3.1 Magnetic Field Levels for AC Cables

Magnetic field levels from AC cables were calculated using computer algorithms developed by the Bonneville Power Administration, an agency of the U.S. Department of Energy (BPA 1991). These algorithms have been shown to accurately predict electric and magnetic fields measured near power lines. The inputs to the program are data regarding voltage, current flow, line phasing, and conductor configurations. Where actual cable geometries were not known, a three-core cable geometry was assumed with 100 mm phase-to-phase spacing. Although measurements and calculations are usually referenced to a height of 1 m (3.28 feet) above ground according to standard practice (IEEE Std. 644-1994, R2008), the modeling fields associated with both AC and DC cables were modeled at the surface of the seabed along profiles perpendicular to lines, unless designated otherwise, and for balanced currents on the cables.

The average AC magnetic field was calculated by taking the average of the magnetic field for each project involving AC cables. Input data for these calculations were taken from projects listed in Appendix Table B-1. The results were tabulated in Appendix Table B-2 at locations along and above the seabed.

Since many of the projects involved single 3-core cables buried in varying depths, Appendix Tables B-2 and B-9 through B-12 can be used to estimate the magnetic field in future projects with similar arrangements. Because the magnetic field scales linearly with line current, one can use these tables to predict the AC magnetic field at locations along and above the seabed for a cable with a known line current and a burial depth of 0.5m, 1m, 1.5m, or 2m.

2.3.2 Magnetic Field Levels for DC Cables

The magnetic field from DC cables was modeled by applying the law of Biot-Savart. In this approach, the magnetic field B from each conductor is obtained $=\mu_0 I/2\pi r$, where μ_0 is the permeability of free space, I is current, r is the distance radially away from the conductor, and combined vectorially. For bipolar systems, where the distance of cable separation was not known, a 0.5 m separation was assumed. The input data used for these calculations were taken from projects listed in Appendix Table B-1. The average DC magnetic field was calculated by taking the average of the magnetic field for the collection of projects involving DC cables. The results were tabulated in Appendix Table B-4 at locations along and above the seabed.

Appendix Tables B-7 and B-8 can be used to estimate the DC magnetic field contributed by DC cables in future projects with similar arrangements. Because the magnetic field scales linearly with line current, one can use these tables to predict the DC magnetic field at locations along and above the seabed for a cable with a known line current and a burial depth of 1 m and cable separations of 0.5 m and 1 m.

The DC magnetic field contributed by submarine cables interacts with the geomagnetic field. To describe the total field produced by the earth and a DC cable, values of the x , y , and z coordinates of the local geomagnetic field are estimated from the current International Geomagnetic Reference Field (NGDC 2010) and are combined with computed magnetic field components by vector addition. As with AC cables, the fields associated with the DC cables were modeled at the surface of the seabed along profiles perpendicular to the lines unless otherwise indicated.

2.3.3 Induced Electric Field Levels for AC cables

The time-varying flow of electrical current in an AC submarine cable will induce an electric field in the surrounding marine environment (e.g., Huang 2005). Consideration of the magnitude of this electric field within an organism requires consideration of the size of the organism and its distance from the cable. The electric field induced in an organism by an AC magnetic field was determined by modeling the organism as a homogeneous ellipsoid as described by ICES (2002).

2.3.4 Induced Electric Field Levels for DC cables

Electric fields occur naturally in the marine environment through the movement of charges in seawater from the earth's static magnetic field. Thus, the movement of current through the vertical component of the earth's field will induce a horizontal electric field. If the presence of a DC cables increases or decreases the strength of the earth's field, then the induced electric field will be affected. To illustrate how these potentials might vary around a DC submarine cable, induced electric fields were modeled by applying Lorentz's law (in which: Electric field $E=F/q$ and $F = qvB\sin\Theta$, where F = force, q = the electric charge, v = velocity of the charge, B = magnetic flux density, and $\sin\Theta$ = sine of the angle Θ between the directions of v and B) and assuming a sea current flow of 5 knots (2.57 m/sec). No consideration of the background geomagnetic field of the earth was considered in these calculations.

2.4 IDENTIFICATION OF PRIORITY SPECIES

An important goal of this project was to identify species in marine or estuarine waters of the US that may be sensitive to EMFs. Two challenges related to this goal are the vast numbers of marine species and the wide disparity in both the quality and quantity of information available on sensory capabilities for each species. A third challenge is that research on sensitivity to electric or magnetic fields has focused on a relatively small subset of species. Thus, for many species, information on sensory capabilities must be inferred based on data available for related species. To address these challenges, a weight of evidence approach was used to identify a list of "priority species" that may be sensitive to effects from EMFs. This approach considered available information on sensitivity relative to expected levels of EMFs, but also incorporated management considerations such as the conservation or fisheries management status of a species.

Priority species for analysis of potential impacts related to EMFs were identified through a stepwise process. This process resulted first in a preliminary list that reduced the total of all species in US marine and estuarine waters to those of particular interest. The preliminary list was then further reduced to a listing of priority species for which additional natural history and ecological information could be gathered to further inform assessment of potential impacts.

The first step towards compiling a preliminary list was to identify sensitive species. A comprehensive literature search and information gathering effort (see section 2.1) was conducted to identify marine species in which direct evidence of sensitivity to electric or magnetic fields has been reported. This listing included both US and foreign species. The worldwide listing of sensitive species was then compared to species that occur in waters of the continental US (the contiguous states plus Alaska). The distribution of each sensitive species on the worldwide listing was evaluated to identify those from US waters as distinct from foreign species. The listing of sensitive species was then ordered phylogenetically (within major groupings) to facilitate comparisons with related species for which direct evidence of electro or magnetosensitivity has not been reported. Using the worldwide listing as a basis, species from US waters were added to the list if they are in the same taxonomic family as a species for which evidence of sensitivity has been reported. For invertebrates, only species with conservation or management status were added to the list. In addition, to ensure careful consideration of species with the highest conservation status, all Federally-listed Threatened or Endangered species (T&E species) were also added to the list. Thus, the preliminary list included species that met one or

more of the following criteria: (1) evidence of E or M sensitivity, or (2) species from US waters related to (family level) species with reported evidence of E or M sensitivity, or (3) T&E species.

The preliminary species list was then evaluated to identify priority species. First, all species that do not occur in US waters were removed from the list. Species that have been evaluated for sensitivity to electric or magnetic fields, and found not to be sensitive, were also removed. Priority designation was then based on the potential for EMF impacts and on conservation or fisheries status, with the following criteria used for the assessment: (1) the reported range of sensitivity to electric or magnetic fields in comparison to the expected intensity (from reported data and modeling results) of electric or magnetic fields from undersea cables; (2) relatedness to species with direct evidence of sensitivity if none exists for the species in question; (3) strength or significance of responses to electric or magnetic fields; and (4) Federal conservation status (threatened and endangered species). Natural history data was then collected for all priority species, which can be used to evaluate the likelihood of encountering undersea cables based on habitat usage for each species as compared to location of proposed offshore renewable energy facilities. Along with this natural history data, all Federally-managed fisheries species with designated Essential Fish Habitat (EFH species) were identified. An exception to this approach was made for invertebrate species because little research has focused on determining their electro- or magneto-sensitivities. Motile invertebrates that are associated with the substrate have the potential to be exposed to the highest field strengths if they reside or move about in the vicinity of a undersea power cable. Therefore, several arthropod species that are of high commercial or ecological importance were included as priority species even though there is no available evidence about their electro- or magneto-sensitivity.

3. LITERATURE SEARCH AND INFORMATION GATHERING RESULTS (TASK 1)

Search efforts resulted in the selection of 493 references that were included in the EndNote database. Fifty-two of these references pertain to existing and proposed undersea power cables and provide a basis for characterizing and modeling expected EMF levels around cables for offshore renewable energy facilities. Four hundred and forty-one references in the database pertain to biological aspects including sensitivity to EMFs, natural history of sensitive species, and potential ecological impacts from EMFs. These results reflect the following search efforts: (1) a targeted search for information to characterize EMFs from undersea power cables (2) a comprehensive search to identify sensitive marine species and potential impacts from EMFs (3) and a targeted search for natural history data to help characterize potential impacts to marine species in US waters. An overview of references in the database is provided in the sections below.

3.1 EXISTING AND PROPOSED UNDERSEA POWER CABLES

A total of 52 references to support the characterization and modeling of EMFs from undersea power cables are included in the database. Appendix A-1 provides an annotated listing of these references. References related to power cables and EMFs provide information on topics ranging from design and configuration of undersea cables to natural sources of EMFs in the marine environment. The references address the physical aspects and engineering considerations related to EMFs. The majority of these references are technical reports (31), but the category also includes journal articles (5), web pages (6), 1 computer program, 1 SOP, and 4 books.

3.2 MAGNETOSENSITIVE AND ELECTROSENSITIVE MARINE SPECIES

A total of 441 references in the database cover biological topics including magnetosensitive and electrosensitive marine species, and ecological effects of EMFs from undersea power cables. Biological references in the database are divided into categories by subject matter. Appendix A-2 provides an annotated listing of biological references, categorized by subject.

Two of the subject categories are for general references. These general references provide topical overviews and are typically relevant to organisms in a range of taxonomic groupings. The first general category includes references that review information on the topics of electro or magnetoreception (or both) in marine species. These are typically books, book chapters, or review articles in journals (Table 3.2-1). These references provide an excellent starting point for understanding the breadth of research on marine species with capabilities to detect magnetic or electric fields.

The second general category includes references that discuss potential ecological effects of EMFs from undersea power cables. Most of these references are technical reports, though journal articles, books and other categories are also included (Table 3.2-1). Many of these references come from work done in European waters. Others represent impact assessment work related to early offshore alternative projects in US waters.

Table 3.2-1

Number of general references covering electro or magnetoreception and EMF impacts by reference type.

Topic	Reference Type				
	Journal article	Technical report	Book	Other (e.g., thesis, web page, etc.)	Total references
Electro or magnetoreception	45	0	12	2	59
EMF Impacts	5	24	2	2	33

The remaining categories are defined by major taxonomic groupings of sensitive marine species. Elasmobranch fishes are covered first throughout this report based on robust evidence that all members of this group are sensitive to EMFs. Other groups for which evidence of sensitivity to magnetic or electric fields has been reported include marine mammals, sea turtles, other fishes (groups other than elasmobranchs), various invertebrate groups, and various groups of microorganisms. Table 3.2-2 provides the number of references in the database for each of these taxonomic groups by subject and reference type. Ten references were selected for the database for microorganisms since important early research on magnetosensitivity was done on magnetosensitive bacteria. Microorganisms are not covered in the synthesis portion of the report, which addresses potential effects of anthropogenic EMFs to marine species.

Table 3.2-2

Number of references selected for each group of marine organisms by subject and reference type.

Marine Taxa	Subject			Reference Type				
	Electroreception	Magnetoception	Natural History	Journal article	Technical report	Book	Other (e.g., thesis, webpage, etc.)	Total references ¹
Elasmobranchs	141	27	22	136	11	15	13	175
Other fishes	53	50	15	88	5	7	9	109
Mammals	1	13	22	19	4	7	6	36
Turtles	0	39	8	37	3	4	2	46
Invertebrates	3	31	6	32	1	0	4	37
Microorganisms	0	10	na	10	0	0	0	10

¹ Although the sum across reference types equals total references, the sum across subjects may exceed the total since some references cover multiple categories

4. INFORMATION SYNTHESIS (TASK 2)

4.1. EMFs FROM UNDERSEA POWER CABLES

Undersea power cables are a source of EMFs that may affect marine species. To investigate this possibility, the first step is to characterize EMFs from undersea cables. The following sections present a review and analysis of information and data to achieve this objective. First, we consider the existing environment into which EMFs from undersea cables would be added. The characteristics of EMFs and the sources of these fields in the ocean environment, prior to the addition of undersea cables, are reviewed in section 4.1.1. Next, we consider design characteristics and cable configurations based on a review of existing and proposed cables in section 4.1.2. The expected levels (magnitude and extent) of EMFs for various cable systems are then modeled using data gathered for existing and proposed cables in section 4.1.3. Finally, data gaps, research priorities, and post-construction monitoring are discussed in section 4.1.4.

4.1.1. EMFs in the Marine Environment

EMFs in the marine environment come from both natural and anthropogenic sources. Some marine species that are sensitive to EMFs have specialized sensory organs that allow them to detect and process the complex and dynamic signals from natural sources of EMFs. Other species have putative mechanisms for detecting and responding to environmental EMFs. How these organisms respond to EMF from man-made sources is not well-studied. The focus of this report is on fields from man-made undersea power supply cables. The following sections review characteristics of the electric and magnetic field components of EMFs (section 4.1.1.1) and describe and discuss both natural (section 4.1.1.2) and anthropogenic (section 4.1.1.3) sources.

4.1.1.1. Electromagnetic Fields

The term electromagnetic field is frequently used to refer to electromagnetic energy across a wide frequency spectrum ranging from the earth's natural fields to cosmic radiation. Also, it is frequently used to refer to that part of the electromagnetic energy spectrum where electric and magnetic fields are coupled and radiate away from sources. The principal sources of electromagnetic energy in the marine environment are static and extremely low frequency fields (0- 3000 Hz) (IEEE, 1988). Since electric and magnetic fields in this frequency range are treated as independent sources, we will refer to electric and magnetic fields separately to avoid confusion. Electromagnetic fields as used here refer to electric and magnetic fields are created by electric charges. For energized power cables, the difference in electric potential (voltage) between the conductors creates an electric field. The strength of the electric field is expressed in units of volts per meter (V/m).

The flow of electricity in a conductor, i.e., the movement of electric charges or current, creates a magnetic field. Magnetic fields surround magnetic materials (in which the field is created by the coordinated spins of electrons and nuclei within iron atoms) and electric currents. The magnitude of the magnetic field is usually expressed as magnetic flux density (hereafter referred to as the magnetic field) in units of gauss (G) or tesla (T). Publications in North America most often report magnetic flux density in G while in scientific publications and in Europe, T is more

commonly used. The units are interconvertible by the expression $0.001 \text{ G} = 1 \text{ milligauss (mG)} = 0.1 \text{ microTesla } (\mu\text{T})$.

Electric and magnetic fields are characterized by their frequency. Time-varying fields are referred to as alternating current (AC) fields and are generated by organisms (i.e., biogenic), environmental sources, and man-made power systems. In North America, the fields from the power system oscillate 60 times per second, i.e., at a frequency of 60 Hertz (Hz). In Europe and Asia the frequency of these fields is 50 Hz. These 50 or 60-Hz fields from power systems are accompanied by weaker harmonic fields that are integer multiples or fractions of the fundamental frequency. In power systems, field magnitudes at harmonic frequencies are limited by the design of electrical equipment, and can be further attenuated by filtering. Static fields that do not vary appreciably over time (a frequency of 0 Hz) are also produced by organisms, environmental sources, and man-made power systems. Permanent magnets and direct currents (DC) flowing in conductors produce static DC magnetic fields.

An important characteristic of electric and magnetic fields not shared by most other measured attributes of the environment is that they are vectors, that is, they are directional. This directional property explains why the magnetic field from a compass needle points in a north – south direction. Vector fields from different sources can cancel as well as add to each other, depending on their relative orientation. So, for example, the magnetic field at a point near one conductor can be reduced or increased by placing another conductor nearby, depending upon the orientation of the field vectors.

4.1.1.2. Natural Sources of EMFs in the Ocean

There are three primary natural sources of EMFs in the marine environment, the earth's geomagnetic field, electric fields induced by the movement of charged objects (e.g., currents or organisms) through a magnetic field, and bioelectric fields produced by organisms.

The Geomagnetic Field

The earth's geomagnetic field is the dominant source of DC magnetic fields in both land and marine environments. The intensity varies with latitude; the lowest values of $\sim 30\mu\text{T}$ are measured near the equator and higher values up to $\sim 70\mu\text{T}$ are measured near the north and south poles.

The background geomagnetic field at the earth's surface is a static field that largely originates from direct current (DC) flow in the liquid part of the earth's core and from metallic elements in the crust of the earth. The magnetic field of the earth has a dipole structure like that of a bar magnet, with the poles of the dipole closely aligned with the geographic poles of the earth. This accounts for the orientation of a compass needle in the magnetic north – south direction.

The geomagnetic field is described by vectors in the x- and y- axes of the horizontal planes and the z-axis in the vertical plane, each characterized by a field strength value. Most often when we refer to the intensity of the field, however, we mean the total root-mean-square (rms) flux density. In this case, *Total Magnetic Field* = $(B_x^2 + B_y^2 + B_z^2)$ where B_x , B_y , and B_z are the magnetic flux densities along each axis. In addition, reference is made to the declination of the horizontal field (the angle between magnetic north and the true geographic north pole of the

earth) and the inclination of the field (the angle between the horizontal plane and the total magnetic field vector).

A map illustrating variations in the geomagnetic field over the earth's surface by color shading and contour lines of equal flux density is shown in Figure 4.1-1. In this figure, the geomagnetic field is expressed in units of nanotesla (nT) where $100,000 \text{ nT} = 1 \text{ G}$. The highest values are measured at the magnetic poles ($\sim 70,000 \text{ nT}$) and lowest at the equator ($\sim 30,000 \text{ nT}$), i.e., 70 and $30 \mu\text{T}$ respectively. The geomagnetic field essentially is constant with variations over a day less than about 0.2 percent. There is geological evidence that the polarity of the earth's geomagnetic field reverses at intervals of thousands to millions of years (NGDC, 2010).

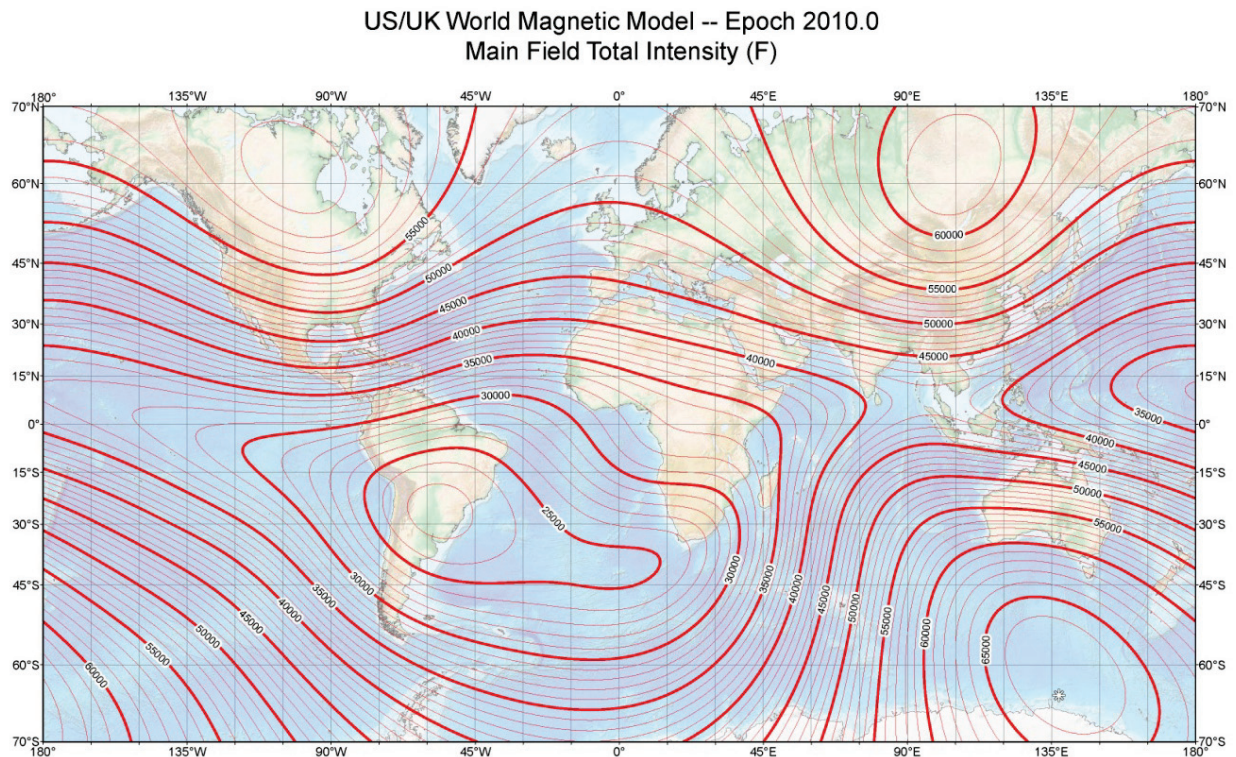

Figure 4.1-1. Map of total intensity of main geomagnetic field (Contour interval 1,000 nT; NOAA, 2010).

In addition to this background field, local variations in the geomagnetic field (magnetic field anomalies) may be produced by the presence of a wide variety of ferromagnetic sources, including shore-based structures (docks and jetties), sunken ships, pipelines, and ferromagnetic mineral deposits. The field intensity experienced by such sources varies with distance; near some sources, the background magnetic field could be perturbed by up to hundreds or even thousands of nT.

Induced Electric Fields

The Lorentz force describes the electric field produced by the movement of charges in a magnetic field. In the marine environment, electric fields are produced by the natural movement of charges in seawater through the geomagnetic field and are influenced by the direction of

movement of the ocean current or organism relative to the magnetic field. Thus, ocean currents create widespread and localized electric fields. These can be predictable as in tidal streams and can occur in the shallow waters during tidal ebb and flow. The electric fields are relatively small (on the order of 0.05-0.5 μ V/cm, Kalmijn 1982). Measurements of the electric field in the English Channel have been reported by Enger at about 0.3 μ V/cm (Poléo, et al. 2001). Higher values are measured over muddy seabeds (0.75 μ V/cm) (Pals, et al. 1982) and during geomagnetic storms (0.6 - 1.25 μ V/cm) (Brown, et al. 1979).

In a similar fashion, mobile organisms experience electric fields induced by the movement of charges in their body through the earth's geomagnetic field that depend on the velocity of movement and direction of movement. For example, the heads of elasmobranch fish contain long jelly-filled canals which end at sensory bulbs known as the ampullae of Lorenzini; the canals have a high electrical conductivity similar to seawater. As the fish swims through the earth's magnetic field a small voltage gradient is induced in the canals, which is detected by the ampullary sensory cells. A detailed discussion of the physical principles underlying the induction of electric fields by ocean currents and by the movement of marine organisms through the geomagnetic field is found in Kalmijn (1984).

AC electric fields and currents are also induced in closed conducting loops in proportion to and at the same frequency as the rate of change of an AC magnetic field as described by Faraday's law. The electric currents so induced produce magnetic fields that oppose the magnetic field from the source. Thus, in seawater natural or man-made AC magnetic fields will also be sources of induced AC electric fields.

Bioelectric Fields

Electric fields also are directly produced by living organisms. The beating of a heart, the nerve impulses within an organism, and the uneven distribution of charged ions are examples of AC and DC electric fields of biological origin; these are known collectively as 'bioelectric fields.' Some marine organisms use these fields to find each other or to locate prey that they are hunting. For example, the freshwater electric eel is capable of generating strong electric fields (hundreds of V/cm) that can stun prey or defend against predators. Although no marine eels are known to generate this level electrogenic force, there are several examples of torpedo ray and numbfish elasmobranchs that produce strong electric discharges for defense or prey capture.

4.1.1.3 Anthropogenic Sources of EMFs in the Ocean

There are a number of potential sources of anthropogenic EMF. Undersea cables used for power generation are notable sources (Kullnick 2000) but telecommunications cables, submarine communication cables, and electrolysis-based sources may also generate EMFs. Submarine oil and gas pipelines may be heated by induction (setting up a magnetic field) or directly (setting up an electric field; Gill et al. 2005). Electric fields are produced by the potential differences between metals with different galvanic potentials in seawater and the flow of a steady current, and so cathodic protection systems on submarine pipelines, ship wrecks and ships on the surface are sources of both DC electric and magnetic fields. Other sources of these fields include marine installations and undersea telephone and communication cables. These sources all produce substantially weaker fields than do undersea power cables, which are reviewed in the following section.

4.1.2. Review of Existing Information on Undersea Power Cables

4.1.2.1. Existing and Proposed Undersea Power Cables

Undersea power cables have the potential to perturb the natural electric and magnetic field environment in surrounding waters. Such cables are used to connect power systems across water bodies, and more recently, to bring to shore power generated by offshore energy facilities. Table B-1 in Appendix B lists 24 undersea cable projects identified in U.S. and foreign waters and provides additional data.

Cable systems carrying power from individual wind turbines may be laid just on top of the sea bed or buried a meter or more below the bottom. Higher voltage cable systems, however, are typically buried underneath the seabed to minimize the possibility of physical damage from events such as anchor strikes, entanglement by fishing gear, or from cable scour movement. Yet, there may be circumstances where short sections of the higher-voltage cable systems may not be buried; for example, cable crossing over rocks or ship wrecks, or cable uncovered by sand waves.

An example of the layout of the inter-array cables from individual generators and the export cable from an offshore wind project is illustrated in Figure 4.1-2.

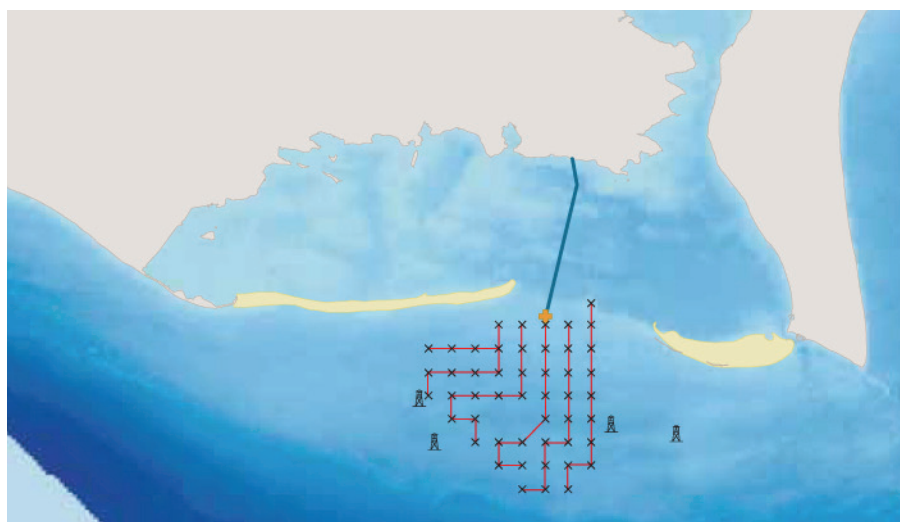

Figure 4.1-2. Example of the layout of an offshore wind project. The location of each turbine is marked by an 'x.' The AC electricity generated by 48 wind turbines is carried over 36-kV inter-array cables to a transformer platform (orange cross). The voltage of the electricity is stepped up to 145 kV for export to shore (modified from Vattenfall, 2009).

A near-shore wind project might have a smaller layout, with the power exported back to shore over a shorter, lower voltage export cable. Layouts and cable configurations for other offshore energy facilities (e.g., wave or ocean current) may well be different from those of offshore wind projects but the types of undersea cables deployed to collect and export power to shore would be similar.

Both AC and DC cable systems are used for power transmission by undersea cables. The design characteristics for each of these systems are described in the following sections.

4.1.2.2. Design Characteristics of AC Cables

An undersea cable designed to carry AC power consists of an inner electrical conductor surrounded by layers of insulating material within conductive and non-conductive sheathing. Typically, three cables are bundled together to carry three-phase currents. Figure 4.1-3 illustrates a typical arrangement of an AC undersea cable system and its composition, including the metallic sheaths. At voltages above 138 kV, the phase conductors may be installed as separate cables, which are often strapped together during installation.

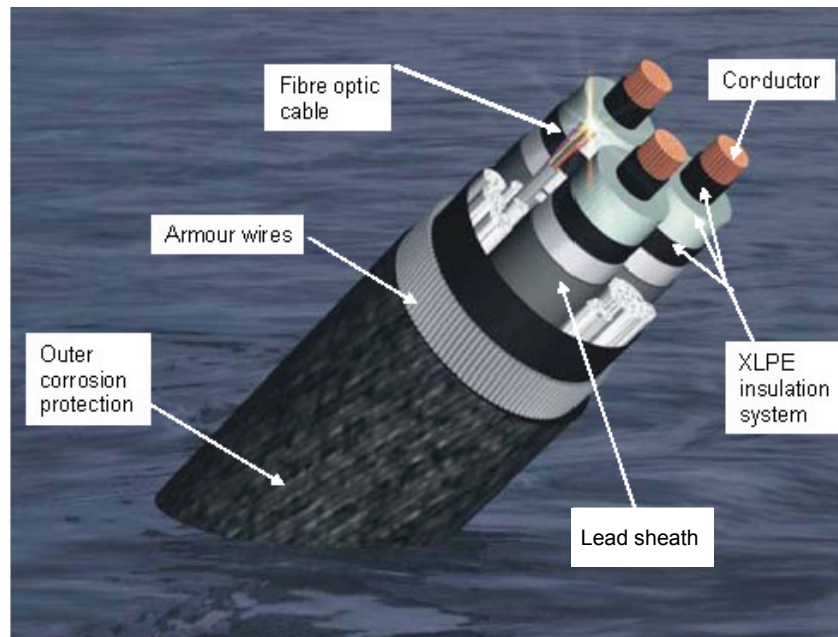

Figure 4.1-3. Configuration of a high voltage AC export cable showing three phase conductors and surrounding sheathing (Nexans 2009)

The conductive sheathing of the AC and DC cables is totally effective in blocking the electric field if the cable is perfectly grounded (see section 4.1.3.2) but is only partially effective in reducing the magnetic field outside the cables. A reduction in the magnetic field outside the cable is produced by shunting of the magnetic field by the cable armoring. The effectiveness of the armoring to attenuate the magnetic field is a function of its magnetic permeability, i.e., higher permeability of the sheathing's magnetic permeability will attenuate the magnetic field by shunting and this has been shown by modeling (CMACS 2003; Huang 2005). Furthermore, eddy currents induced by the AC magnetic fields in sheathing materials with high conductivity will create an opposing magnetic field vector and further increase the partial cancellation of the magnetic field from the cable. Calculations of the magnetic field from a 138-kV AC undersea cable demonstrated that flux shunting accounted for an almost 2-fold reduction in the magnetic field, with a very much smaller reduction attributable to eddy currents (Silva et al. 2006).

Unfortunately, information regarding the conductivity and magnetic permeability of sheathing and armor is almost never provided for undersea cables.

The total magnetic field intensity outside a power-transmission cable is a function of current flow on the cable conductors, distance from the cable, and the arrangement of the conductors within the cable system (see section 4.1.3.4). In North America, the predominant frequency of the magnetic field is 60 Hz, but smaller components are also present at harmonic frequencies (multiples of 60 Hz). Variable-speed wind turbines employing power-electronic converters are sources of harmonic currents and produce magnetic fields at frequencies in excess of 1 kHz (Maduriera, et al. 2004). Harmonic frequencies can be controlled by power-electronics design, however, and the harmonics produced by modern wind turbines are observed to fall within an acceptable limit of less than 5% Total Harmonic Distortion that protects electrical equipment from power losses and overheating (Chen and Blaabjerg 2009; Papathanassiou and Papadopoulos 2006). Harmonic fields from a DC cable have been estimated at 2% of the DC field (Koops 2000). Although harmonic and subharmonic EMF from either AC or DC cables may be of small magnitude, their detection by magneto- or electro-sensitive marine animals is currently documented in the literature. Harmonics would appear to be of lesser significance than the primary field sources of cables given their small magnitude and because the peak frequency sensitivities of electro- and magneto-receptors of most species studies are less than 10 Hz. There are only two species of electric fish from Africa and South America with tuberous receptors reported to be capable of responding to electric fields from 50-200 Hz (Bullock 2002).

4.1.2.3. Design Characteristics of DC Cables

While undersea AC power cables are most common, DC cable systems have become increasingly common as undersea links between power grids, or as transmission lines from large, distant offshore wind facilities to mainland grids. The increasing use of undersea DC cable systems is due in part to their ability to carry power over long distances using only two cables (AC cable systems require three cables) with lower power losses.

Monopole System

A DC power transmission system consists of a rectifier station to convert AC power to DC power, a cable to transmit the DC power, and an inverter station to convert the DC power back to AC power. A simple drawing of a DC power system is shown in Figure 4.1-4.

In the monopolar DC system shown in Figure 4.1-4, DC power is transmitted on a single high-voltage direct-current (HVDC) conductor at one voltage with respect to ground, say +400 kV. The circuit is completed by current return on a low voltage return cable. An example of a DC power conductor with integrated return cable developed for the 290 km, 400-kV Basslink project is shown in Figure 4.1-5. The inner copper conductor of the power cable is surrounded by insulation, which in turn is surrounded by conductive lead sheathing and outer galvanized steel armoring. A separate, parallel cable (Separate Return Cable - SRC) is also surrounded by insulation and outer armoring and is strapped to the DC conductor and laid like a single cable under the seabed to carry the DC current back to the source. Similar SRC cable designs have been deployed in the SwePol Link and the Neptune Regional Transmission System. In some installations (not shown), the return cable only may be strapped to the cable at frequent intervals or installed further away, e.g., 20 m.

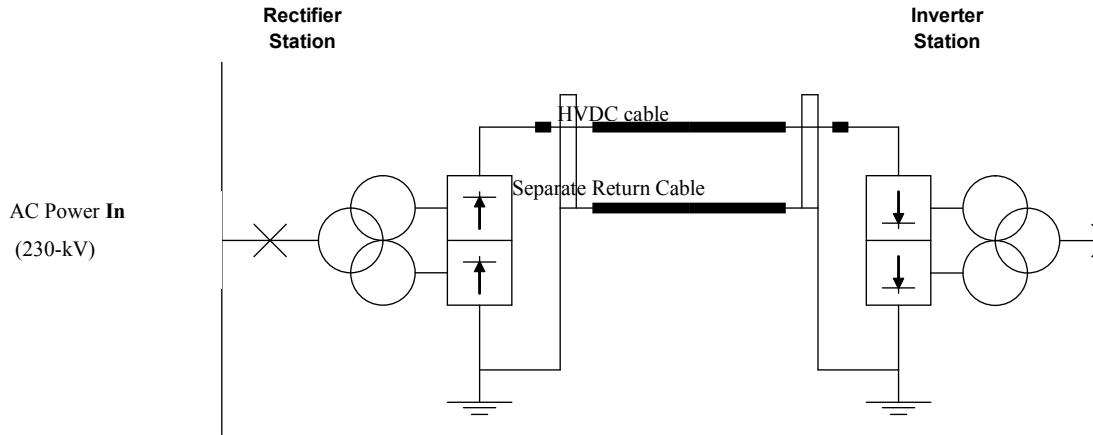

Figure 4.1-4. Example of a monopolar DC cable system with a separate return conductor (SRC) (Exponent 2001).

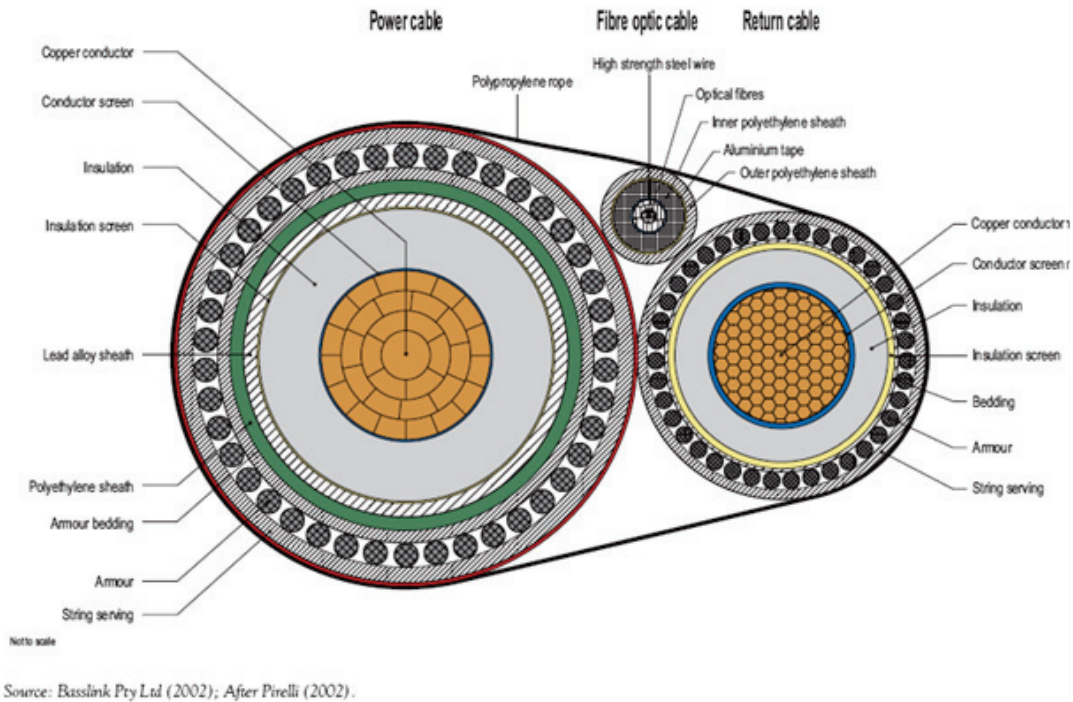

Figure 4.1-5. Monopolar DC cable system with an SRC (TPC 2001)

Another monopolar DC cable system design uses a coaxial cable with an integrated return circuit (IRC), as illustrated in Figure 4.1-6. The cable consists of a high-voltage copper center conductor (labeled as 1 on Figure 4.1-6) surrounded by insulation and the return current flows at low voltage on surrounding concentric cylindrical copper conductors grounded at one end (labeled as 11 and 13 on Figure 4.1-6). No current flows on any other paths besides the center conductor and the outer return circuit.

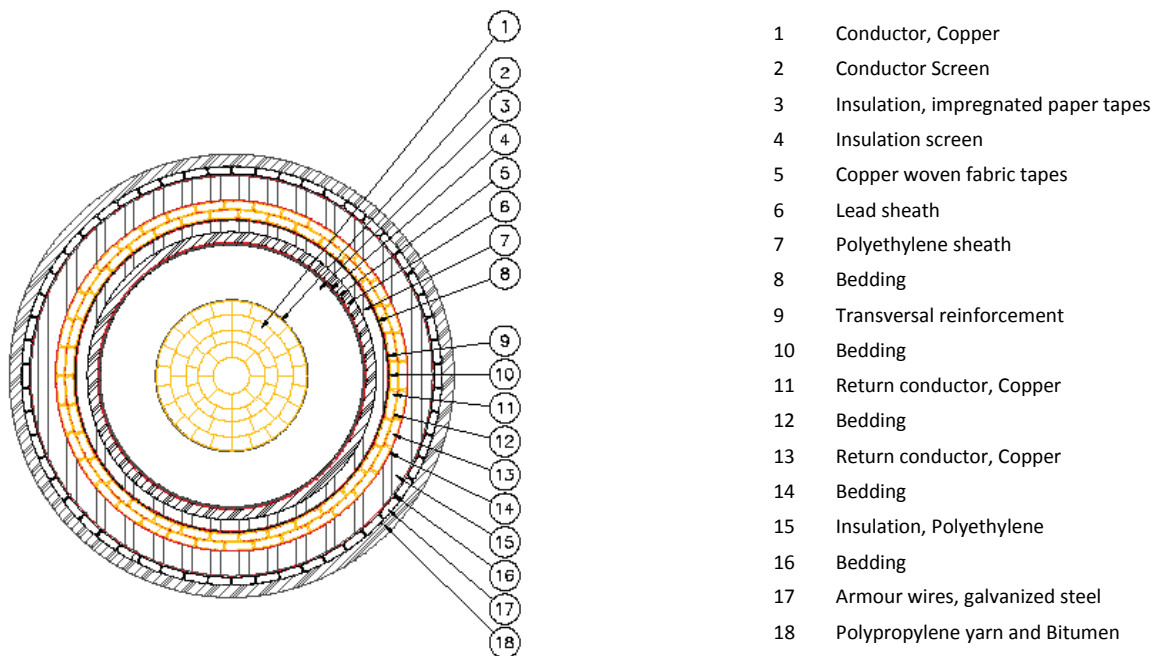

Figure 4.1-6. Monopolar DC cable system using coaxial cable with an IRC (Exponent 2001).

A third type of monopolar DC cable system consists of a single power cable like the large power cable shown in Figure 4.1-5 but the return current flows not through a smaller return cable as shown, but through the ocean from sea electrodes at either end of the cable instead of through a metal conductor (the latter illustrated in Figure 4.1-5). Examples of this design include the first undersea DC cable system, the Gotland 20 MW, 90km 100-kV Gotland cable from mainland Sweden to Ygne Island (1954; dismantled in 1986; Asplund et al. 2003) and the 231 km 450 kV Baltic cable system, one of the longest undersea DC cable systems, completed in 1994 between Sweden and Germany (Baltic Cable 2010). This design leads to higher magnetic fields from the cables, electric fields, the generation of electrolysis products, i.e., oxygen and chlorine at the sea electrodes, leading to hypochlorite at the anode and hydrogen, calcium, and magnesium hydroxides at the cathode (Koops 2000), as well as enhanced corrosion of metal structures. Therefore, monopolar DC cables with a sea return may not be appropriate for locations where these environmental effects would be important and are expected to be proposed infrequently for future projects. As an example, the original proposal for the Basslink project was for a monopolar cable with return through the sea but was changed to a monopole cable with an integrated metallic return because of concerns about corrosion of undersea structures and other effects (TPC 2001).

The process of converting 50-Hz or 60-Hz AC power to DC power creates currents and voltages at harmonics of 60 Hz whatever the design of the cable system. To minimize harmonic currents and voltages, both AC and DC cable systems are designed with filters that are placed at both the rectifier and inverter stations; any residual harmonics would be of relatively low magnitude in comparison to the unfiltered currents and voltages. For the IRC system, any harmonic currents would be equal and opposite on the two conductors and the resulting magnetic fields would be zero, as in the case of DC currents within the IRC systems.

Bipole System

A bipole DC transmission system transmits power at two voltages with respect to ground, say, +500 kV and –500 kV. A bipole system requires two conductors at high voltage and opposite polarity (+ and -) and a third conductor to serve as a return path for any current unbalance between the two poles. As with the monopole system, either a metallic conductor or seawater can provide the system’s return path. If one pole of a bipolar system is out of service, the system can be operated as a monopole system. The 270 km deep-submarine section of the 580 km ±450 kV NorNed Cable Link between Norway and the Netherlands is an example of a bipolar system in which two insulated, metallic sheathed conductors, are contained in flat mass impregnated cable within surrounding steel wire armoring (Skog, et al. 2006).

4.1.3. Expected EMF Levels from Undersea Power Cables

Nineteen of the 24 undersea cable systems identified in U.S. and foreign waters provided sufficient information to characterize the magnetic fields from a range of cable systems. Exponent modeled magnetic fields by methods described in Section 2.1. In the absence of good data about some systems, reasonable assumptions about the cable configurations were made to complete the modeling. The characteristics of these existing and proposed cables are summarized in Table 4.1-1. Additional details of individual projects are provided in Appendix Table B-3.

Table 4.1-1

Undersea power cable designs for submarine crossings and offshore wind projects

Cable Purpose	Voltage (kV)	Power (MW)
<i>Submarine Crossing</i>		
AC	35-230	15-600
DC-bipole	75-500	200-550
DC-monopole	450	600
DC monopole-SRC	400-500	500-660
DC monopole-IRC	500	810
<i>Wind Project</i>		
AC turbine cable	33	1-4
AC export cable	115-132	90-454
DC export cable	200	400

SRC= Separate Return Cable
IRC=Integrated Return Cable

Most of the AC cables were designed to provide connections between land transmission systems and systems operating at 33 kV, 69 kV, 138 kV, 230 kV, and 345 kV. Six cable systems were designed to collect and export power from offshore wind facilities. The inter-array cables that collect the electricity generated by individual turbines operate at 33 kV and systems step up the voltage to 115 kV (Cape Wind) or 132 kV for export to shore. As described previously, the frequency of the magnetic fields from cables in North America is 60 Hz, while in Europe and

Asia it is 50 Hz. NaiKun, Canada’s first offshore wind project, has proposed to convert the AC power collected from the inter-array to DC power and export to shore over a ± 200 kV bipolar cable system. As wind turbines are installed further from shore and the cost of converters decreases, more DC export cable systems are expected. In addition to these cables, there are numerous low-voltage (17-35 kV) AC submarine cables that provide power to offshore oil and gas platforms. BOEMRE has provided examples of these cables in Appendix Table B-13. No information is available about these cables or the load carried, but loads of about 3 MW at 34.5 kV and about 1.5 MW at 17 kV might be anticipated to be similar to or lower than those from AC turbine cables (Table 4.1-1).

4.1.3.1. AC Magnetic Fields

Exponent modeled the magnetic fields for each of the AC cable systems for which data were available. The magnetic fields along the seabed perpendicular to the cables were modeled for 10 AC undersea cables. The results are compared in Figure 4.1-7 and Appendix Figure B-1.

For eight of the cables, magnetic field levels are highest above the cables and diminish with distance from the cables. The intensity of the field over these cables increases in rough proportion to the current flow on the cables, but also is influenced by the separation and burial depth of the cables, with burial below the sea floor serving to increase the distance between the field source and the marine environment. Two other profiles (Cape Wind and Replacement of 138-kV cables in Long Island Sound) show bimodal profiles for cable systems because in these projects the power is carried on two cable sets that are not adjacent. Thus, each cable set

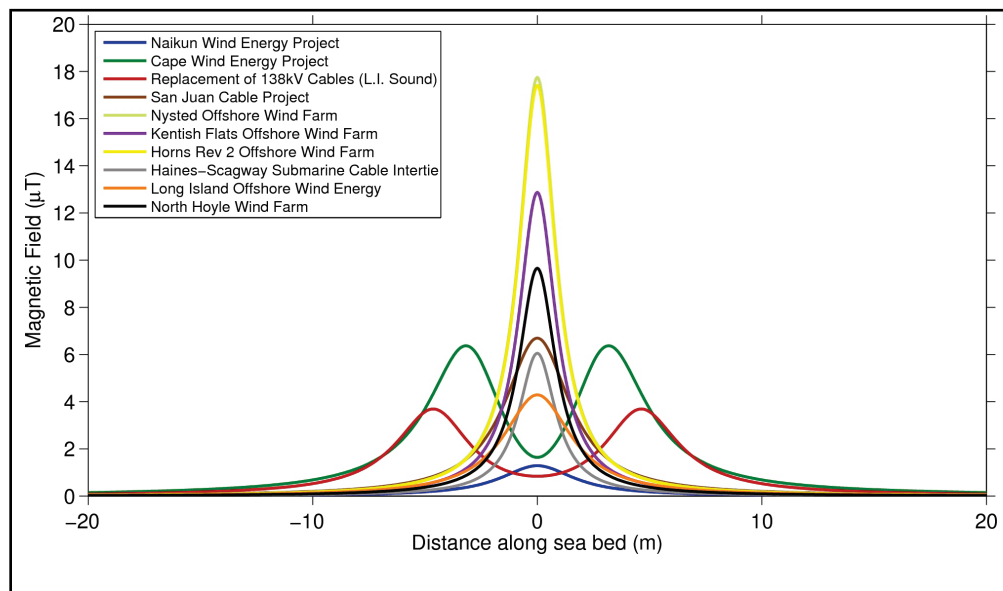

Figure 4.1-7. AC magnetic field profiles across the surface of the seabed for 10 submarine cable systems. Note that the profiles from Horns Rev 2 Offshore Wind Farm and the Nysted Offshore Wind Farm almost completely overlap each other.

produces a magnetic field but the magnetic field is lower because the current flow on each cable is half what would have been produced had the entire load been transmitted on one set of cables.

An average magnetic field profile was calculated averaging the modeled magnetic field profiles shown in Figure 4.1-7 to provide a generic description of the magnetic field profile because of the variation in the configuration and loading of AC undersea cables. The variation in the field values around this average is shown by green shading in Figure 4.1-8.

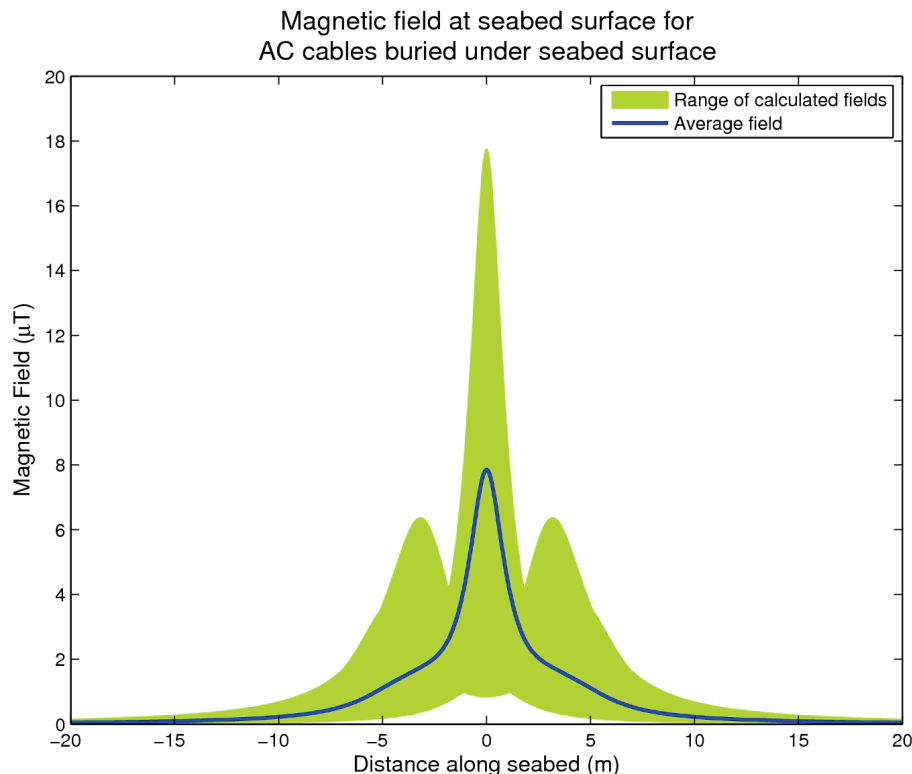

Figure 4.1-8. Average AC magnetic field (blue) calculated at seabed surface for various projects (see Figure 4.1-7 legend for list of projects).

The AC magnetic fields associated with numerous submarine cables providing power to offshore oil and gas platforms are estimated to be about ten percent of the AC magnetic field shown for the Haines-Skagway Submarine cable in Figure 4.1-7.

The magnetic field in the water column vertically above the cable also varies with distance. To facilitate the generic characterization of potential AC magnetic field exposures of both marine organisms that inhabit sea bottom (benthic species) and mobile species found within the water column, Table 4.1-2 provides values of the average magnetic field as a function of distance in both horizontal and vertical directions from an AC cable system. Appendix Table B-4 provides the modeled average project AC magnetic field values for distances to 50 m above the cables and 100 m along the seabed.

Table 4.1-2.

AC magnetic fields (μT) reflecting averaged values from 10 projects at intervals above and horizontally along the seabed assuming 1m burial.

Distance (m) Above Seabed	Field Strength (μT)		
	Horizontal Distance (m) from Cable		
	0	4	10
0	7.85	1.47	0.22
5	0.35	0.29	0.14
10	0.13	0.12	0.08

4.1.3.2 DC Magnetic Fields

In a similar fashion, Exponent modeled the magnetic fields for each of the nine DC cable systems for which data were available without considering any combined effect resulting from the field from the cable and the geomagnetic field (Figure 4.1-9 and Appendix Figure B-2). All cable systems were assumed to be buried 1 m below the seabed. As for the AC cables, the intensity of the field above and around eight of the DC cables increases as a direct function of the current flow, and the configuration of the cables. The SwePol Link shows a bimodal profile and the highest magnetic field peaks, which largely reflects a 20 m separation between the + and return cables. If these cables had been configured very close together, the magnetic field would be expected to be significantly reduced based on this design feature alone (results not modeled). An average magnetic field profile was calculated because of the variation in the configuration

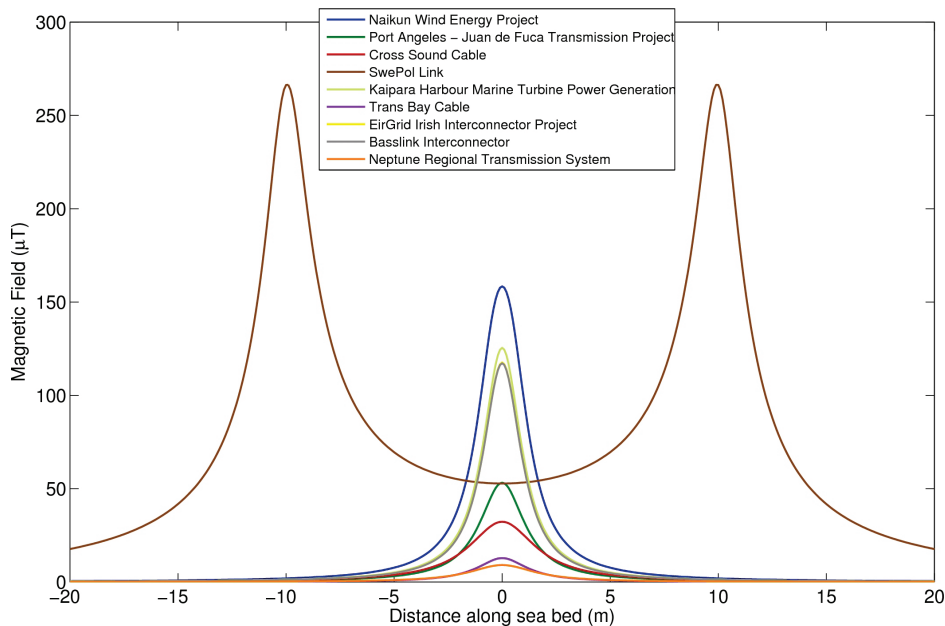

Figure 4.1-9. DC magnetic field calculated at seabed surface for 9 submarine projects using buried bipolar and monopolar (with cable return) HVDC undersea cables. Note that the profiles for the Basslink Interconnector and the EirGrid Irish Interconnector Project almost completely overlap each other.

and loading of DC undersea cables; the variation in the field values around this average is shown by green shading in Figure 4.1-10.

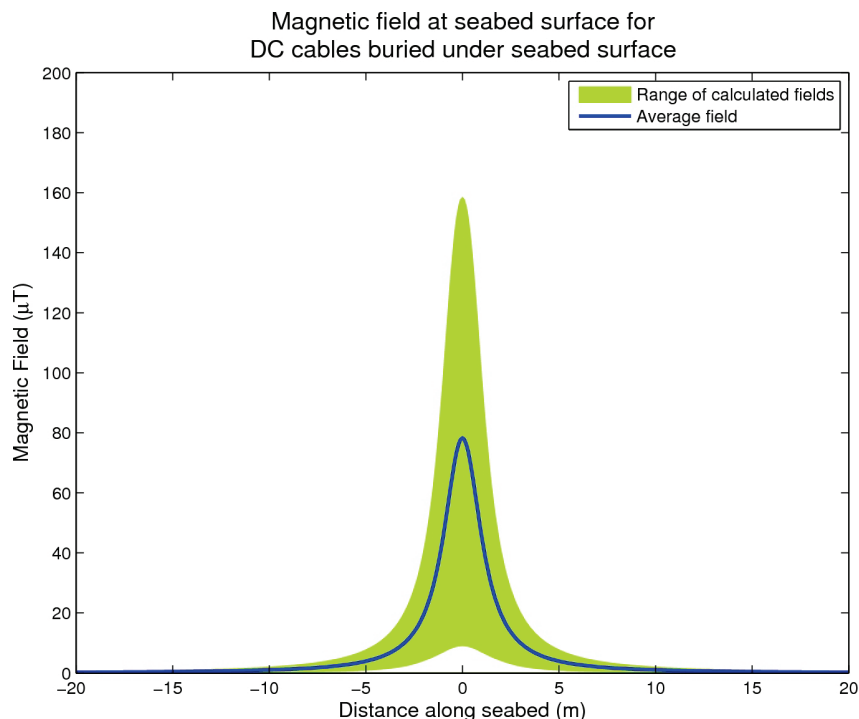

Figure 4.1-10. Average DC magnetic field (blue) calculated at seabed surface for various projects. The SwePol Link project profile was omitted from this plot because its cable configuration is anomalous compared to others that were modeled.

Table 4.1-3 provides values of the average magnetic field as a function of distance in both horizontal and vertical directions from a cable system to facilitate the generic characterization of potential DC magnetic field exposures of both marine organisms that inhabit sea bottom (benthic species) and fin/mammal species found higher in the water column. Appendix Table B-4 provides the modeled average project DC magnetic field values for distances to 50 m above the cables and 100 m along the seabed. Note that the power frequency of cables outside North America is 50 Hz so EMFs from these cables are slightly closer to the range of bioelectric frequencies (generally less than 10 Hz at which sensory receptors of a number of marine organisms are tuned) than the EMFs from 60 Hz power cables.

The magnetic field from DC cables can influence the intensity of the Earth’s magnetic field as well as the inclination and declination of the geomagnetic field. Inclination is the angle between the horizontal plane and the magnetic field vector at a point in space and declination is the angle between the magnetic field and geomagnetic north. While the Earth’s magnetic field generally has a nonzero declination and inclination, the magnetic field from DC cables alters the apparent intensity and direction of magnetic north. The influence of the cables’ field on the Earth’s field varies depending on the orientation of the cables relative to the Earth’s field. The DC magnetic field from cables running perpendicular to magnetic north, for example, will affect the intensity

Table 4.1-3

DC magnetic fields (μT) reflecting averaged values from 8 projects at intervals above and horizontally along the seabed assuming 1m burial.

Distance (m) Above Seabed	Field Strength (μT)		
	Horizontal Distance (m) from Cable		
	0	4	10
0	78.27	5.97	1.02
5	2.73	1.92	0.75
10	0.83	0.74	0.46

and inclination angle of the geomagnetic field, but not the declination angle. In contrast, the DC magnetic field from cables running parallel to magnetic north will affect the declination angle of the geomagnetic field, in addition to affecting its intensity and inclination angle.

This interaction between the DC magnetic field of the cables and the geomagnetic field complicates the evaluation of magnetic fields from DC submarine cable systems as the magnetic field vectors combine with the magnetic field vectors of the geomagnetic field. This means that the intensity, shape, and spatial extent of the resulting magnetic field (cable + geomagnetic) is affected by the orientation of the cable system with respect to the earth's north-south magnetic dipole. An example of this interaction is shown by comparing Figure 4.1-11 to Figure 4.1-12. In Figure 4.1-11, the DC magnetic field from the proposed NaiKun DC cable is modeled without

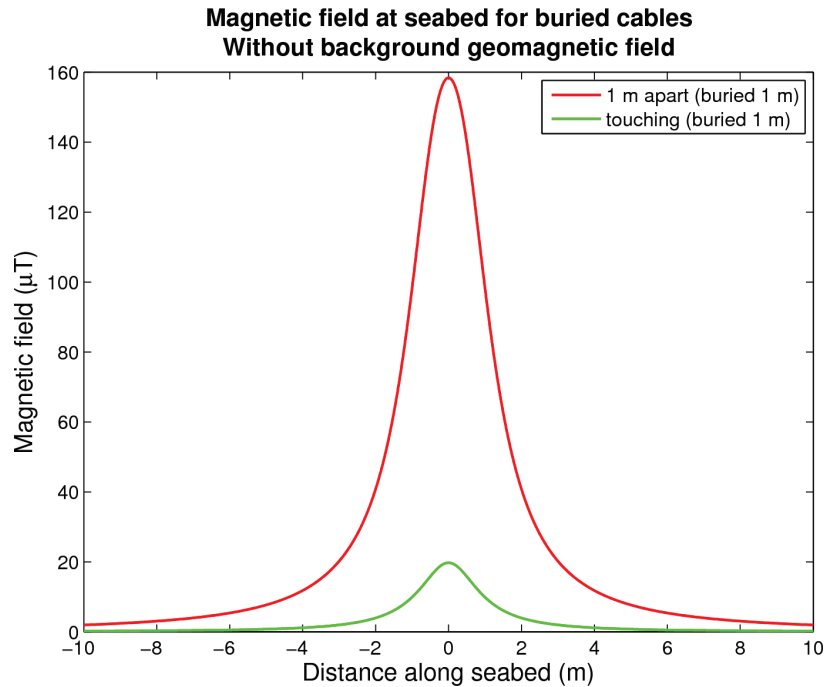

Figure 4.1-11. Modeled profile of DC magnetic field from NaiKun $\pm 200\text{kV}$ cable operating at 400 MW (Exponent and Hatch 2009)

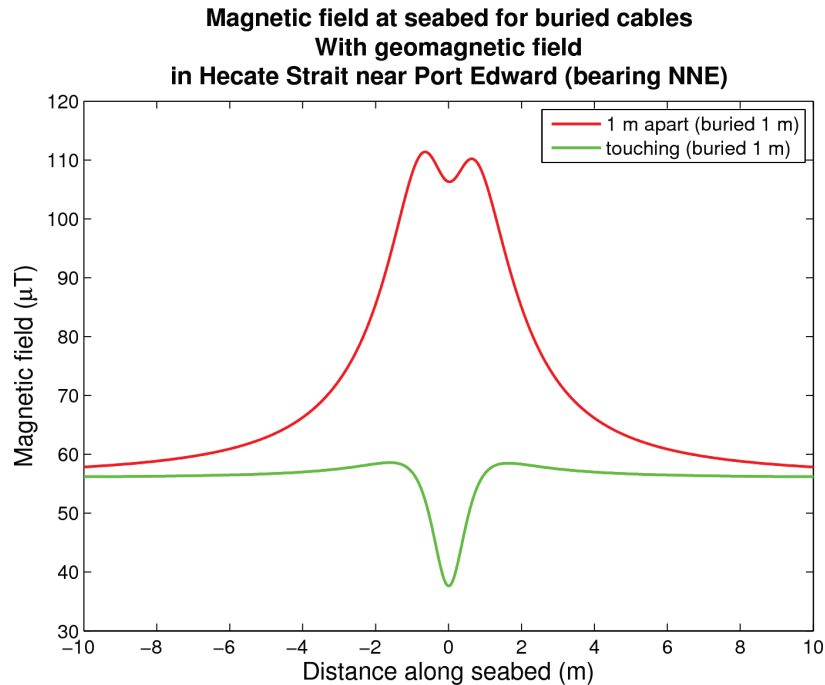

Figure 4.1-12. Modeled profile of DC magnetic field from NaiKun \pm 200 kV cable operating at 400 MW when orientated NNE in the Hecate Strait off British Columbia (Exponent and Hatch 2009).

considering the local geomagnetic field. By comparison, in Figure 4.1-12 the magnetic field from the cable and the local geomagnetic field combined are modeled.

In this example, consideration of the total magnetic field determined by addition of the magnetic field vectors from the NaiKun cable and the geomagnetic field reduces the peak DC magnetic field over the cable by about 31 percent when the cables are separated by 1 m. When the cables are modeled as touching, however, the ambient geomagnetic field is reduced by about 20 μ T over the cable (Figure 4.1-12), but if the ambient magnetic field is not taken into account the modeling in Figure 4.1-11 suggests that the magnetic field would increase by 20 μ T over the cable. Increases in the field above background at some locations occur because the magnetic field vector of the cable is aligned roughly parallel and in the same direction as the geomagnetic field; decreases in field intensity below the background geomagnetic field occur where the magnetic field vector from the cable is oriented in a direction opposite to that of the geomagnetic field. Thus, the orientation of a DC undersea cable with respect to the geomagnetic field will affect the resulting total field.

4.1.3.3 Direct Electric Fields

Except for the case of cable designs using sea electrodes, undersea cables will not generate direct electric fields. Because of the conductive sheathing, the environment outside of both AC and DC cables is shielded from the electric field produced by the voltage on the inner, current-carrying conductor. Using data for Horns Rev, CMACS (2003) provided calculations showing that no electric field would be produced by an undersea cable if covered with conductive sheathing, and

even if somehow the sheathing were not perfectly effective, the electric field would be very small, less than that induced by the magnetic field from the cables, and blocked by burial under the sea bed. For this reason, it can be assumed that an undersea cable will not be a direct source of electric fields in the marine environment if it is perfectly grounded.

If a monopolar DC cable uses the sea as a surrogate for metallic conductor then the electrodes will be a source of an electric field in the sea. The electrodes may occupy 1000-3000 m² and calculated and measured electric fields are less than 20 mV/cm (Koops 2000). The strength of the field will diminish with distance from the electrode.

4.1.3.4 Induced Electric Fields

As described earlier, electric fields occur naturally in the marine environment through the movement of charges in seawater from the earth's static magnetic field. Thus, the movement of current through the vertical component of the earth's field will induce a horizontal electric field. If the presence of a DC cable increases or decreases the strength of the earth's field, then the induced electric field will be affected. To illustrate how these potentials might vary around a DC submarine cable, Exponent modeled the induced electric fields assuming a sea current flow of 5 knots (2.57 m/sec). A summary of the calculations are shown in Table 4.1-4. As mobile marine organisms also cause the movement of electrical charges even in still water, the movement of a fish at 5 knots (an average cruising speed for a shark) would also experience a similar electric field. Appendix Tables B-5 and B-6 provide the modeled average induced electric field values for distances to 50 m above the cables and 100 m along the seabed for currents flowing parallel and perpendicular to the DC cables, respectively.

Table 4.1-4

Modeled average induced electric field from DC submarine cables (V/m) at distances above seabed and horizontally along seabed for cables buried 1m below seabed for a 5 knot current.

Distance (m) Above Seabed	Field Strength (V/m)		
	Horizontal Distance (m) from Cable		
	0	4	10
0	1.94E-04	3.15E-05	7.85E-05
5	1.75E-05	1.62E-05	1.39E-05
10	8.80E-06	8.52E-06	7.13E-06

The time-varying flow of electrical current in an AC submarine cable will also induce an electric potential in the surrounding seawater or an organism. The modeling of this induced electric field requires consideration of the size of the marine organism and its distance from the cable. The larger the organism and the closer it is to the cable, the greater the electric field induced in the organism will be. Table 4.1-5 shows the results of Exponent's modeling of the AC electric field induced in a small shark assumed to be 150 cm long and 60 cm high that is swimming above and parallel to the buried cable. Larger (smalltooth sawfish) and smaller (juvenile sandbar shark) fish were also modeled and those results are reported in Appendix Table B-3. The induced electric fields computed for a smalltooth sawfish were larger and the fields computed for the juvenile sandbar shark were smaller in size than those for the small sand shark at the same distance from the cables (see Appendix Table B-3).

Table 4.1-5

Modeled maximum induced electric field (V/m) in a small shark at various distances above a 60 Hz, AC submarine cables (for averaged designs) buried 1m below seabed

Distance (m) Above Seabed	Field Strength (V/m)
0	7.65E-04
5	3.39E-05
10	1.24E-05

4.1.3.5. EMFs During Non-Normal Conditions

In electric power systems of any complexity there exists the possibility of a disturbance or fault. Under such abnormal conditions, overload or fault currents above a system’s rated current are associated with magnetic fields higher than normal. Protection devices are designed to detect and isolate faults in order to protect equipment and improve service reliability. Because of the way protection devices are designed, an abnormal increase in current and associated change in magnetic field is inversely proportional to the time that such an elevation is allowed to persist. For this reason – and since faults are infrequent in power systems – abnormal operation conditions would be an infrequent and negligible source of EMF exposure.

4.2. MAGNETOSENSITIVE AND ELECTROSENSITIVE MARINE SPECIES

Species that can sense magnetic or electric fields (or both) may use these cues for important life functions ranging from feeding to migration. Such species may also be capable of sensing EMFs from undersea power cables; this suggests a potential for interference with biological processes. EMFs from undersea power cables are characterized above in Section 4.1, providing the physical basis for understanding potential effects to marine species. This section provides the biological information to further consider this question.

Magneto-sensitive and electro-sensitive species have been reported from a wide range of marine groups. Due to robust evidence for sensitivity in elasmobranch fishes, this group is treated first in this report. Marine mammals, sea turtles, other fishes (groups other than elasmobranchs), and invertebrates are also covered based on reported evidence of sensitivity. Each of these groups is analyzed with the objective of identifying US marine species most likely to be sensitive to EMFs. First, we review the evidence basis for sensitivity to EMFs, considering both US species and related species from around the world. To ensure that species with unique conservation status have been adequately considered, all federally listed threatened or endangered marine species are highlighted in this review process. Next, reported information on sensitivity relevant to US species is then compared to modeled estimates of EMF levels from undersea power cables. Any potential impacts suggested by this comparison are discussed. Finally, relevant natural history information including geographic range within BOEMRE planning areas on the Outer Continental Shelf is presented for those species identified as highest priority for further consideration of potential impacts.

Cable sheaths, armoring, and burial will block the electric field of the conductors from reaching the environment. Thus, the magnetic field and induced electric fields are the components to consider for most cable systems. The modeling presented in section 4.1 indicates that the intensity of magnetic and induced electric fields would be experienced as a gradient relative to distance from the cable. The intensity of the fields would increase as a fish approaches the cable, and diminish as it moves away from the cable, either vertically or horizontally. The characteristics of EMFs vary considerably depending upon the type and configuration of cable systems. A variety of design and installation factors affect EMF levels in the vicinity of a cable. These factors, including current flow, distance between cables, cable orientation relative to the geomagnetic field (DC cables only), and burial depth (as it dictates distance between the cable and an organism), are discussed in section 4.1.3.4. Clear differences in EMFs between AC and DC cable systems are apparent. Also, relevant sensitivity levels must be assessed for both magnetic fields (magnetoreceptive species) and induced electric fields (electroreceptive species).

An overview of magneto and electroreception is provided in Section 4.2.1, followed by sections for each major taxonomic grouping (Sections 4.2.2 – 4.2.6), a discussion of potential cumulative effects (Sections 4.2.7), and an assessment of data gaps and research priorities (Sections 4.2.8).

4.2.1. Magneto and Electroreception in Marine Species

4.2.1.1. Sensory Systems in Marine Species

Marine organisms depend on sensory reception for feeding, predator avoidance, reproduction, migration, and other important life functions. Thus, an organism's ability to accurately sense its environment is vital to its survival. A variety of sensory systems are used by marine species to gather information about the external environment. Senses such as vision, hearing, touch, chemoreception (e.g., taste, smell), and equilibrium are familiar and easy to comprehend. Nonetheless, in considering these familiar senses, it is important to keep in mind that the range of stimuli (e.g., sound levels, light wavelengths) perceived by other species can be well outside the sensory capabilities of humans. Hence, some species use senses to perceive the world in entirely unfamiliar ways. A well known example of this is the use of echolocation by many cetaceans to "view" the external environment using sound.

Light availability, and thus vision, in the underwater environment is extremely limited by absorption and varies greatly based on local turbidity levels. In contrast to terrestrial conditions that favor sight, these impediments to underwater vision have put strong selective pressure on marine species for well-developed senses such as hearing, chemoreception, and in certain fish species, electroreception. Furthermore, increasing evidence indicates that many marine species, both vertebrates and invertebrates, can sense the earth's magnetic field, and use this information for orientation and navigation. Magnetoreception has received special attention in animals that undergo long-range migrations to prime feeding or reproductive grounds.

The natural and anthropogenic sources of EMFs in the marine environment are described above in section 4.1.1. These EMFs provide an underwater landscape of magnetic and electric fields that many species can detect. The following sections review the current understanding of

magneto and electroreception in marine species, and discuss the ecological implications of introducing EMFs from undersea cables to the marine environment.

4.2.1.2. Magnetoreception

The earth's magnetic field exists at all terrestrial, aerial and submarine locations on the planet where it provides potential cues for animal orientation and navigation behaviors. The primary field is generated by the subterranean dynamics of the earth's molten core. Magnetic force field lines project from the core and are vertical at the magnetic poles, horizontal at the magnetic equator and inclined at other locations on the earth's surface. The second component arises from magnetic rock in the earth's crust that contributes a residual component to the total field in a site specific manner (Skiles 1985). The residual field is much weaker than the main field in total strength, but is subject to great variation over relatively short distances. Individually or combined these magnetic sources provide potentially important stimuli (magnetic intensity, inclination and declination) that can be used as cues during movements of marine organisms.

Robust evidence indicates that natural environmental magnetic stimuli from the earth are used in various behavioral contexts by a wide variety of marine organisms. A diversity of invertebrates and vertebrates are known to sense, respond to, or orient to magnetic field cues (see Wiltzchko and Wiltzchko 1995 for review). Many conditioning and field manipulation experiments on marine animals demonstrate the ability to detect applied or modified magnetic fields by mollusks (Lohmann and Willows 1987), crustaceans (Boles and Lohmann 2003, Ugolini 2006), elasmobranch fishes (Kalmijn 1982, Hodson 2000, Meyer et al. 2005), bony fishes (Walker 1984, Quinn 1980, Walker et al. 1997, Nishi et al. 2004, Nishi and Kawamura 2006), and sea turtles (Lohmann 1991). Although observational and experimental studies show the ability of marine animals to respond to ambient magnetic stimuli, in the wild this information may be used for determining locations for feeding, reproduction, refugia and different life history-dependent functions.

Sea turtles present the best studied marine vertebrate system (see section 4.2.4, below), with behavioral studies demonstrating the use of magnetic landmarks and a compass sense that provides directional information during long migrations (Lohmann 1991, Lohmann et al. 2001). Sea turtle studies have demonstrated the capability for true navigation towards a goal location, which requires both a compass sense and also a 'map' that provides spatial information on the animal's current location relative to that of the target location. And models exist for 'magnetic maps' to explain these capabilities (Lohmann et al. 2004). Although the turtle magnetic behavior provides the best tested marine vertebrate system, these functional roles for magnetic field information are likely to apply to other marine organisms but for the most part remain to be formally tested in marine fishes and other groups. In comparison, the use of a magnetic map for navigation by an invertebrate was demonstrated for the spiny lobster (Boles and Lohmann 2003).

There are several proposed and competing models to explain how magnetic stimuli are detected and information integrated to provide cues for orientation and navigation behavior. The magnetite detector, electromagnetic induction, and optical pumping models are described here:

Magnetite detector – The magnetite-based sensory model proposes that magnetic fields are transduced by small magnetic crystals (magnetite) in special receptors on the head of the animal. As in the case of a magnetic needle in a compass, small (<50µm) single-domain magnetite crystals will align with the incident magnetic field and may exert a torque force or rotation that directly modulates ion channels of the cell. Models of this mechanism indicate that magnetite based detectors could respond to field differences as low as 10nT (Kirschvink and Gould 1981; Kirschvink and Walker 1985; Kirschvink 1992; Presti and Pettigrew 1980). Significant work to support the existence of a magnetite receptor system in bony fish is discussed in section 4.2.5. Several other magnetite based systems are proposed that include superparamagnetic sites found in birds and bees (reviewed in Walker et al. 2007) but this is not well studied in marine species.

Electromagnetic induction – The magnetic induction model proposes that electrosensitive fishes may obtain directional information on an impinging magnetic field via induction of electromotive forces on the body that are detected by their electrosensory system. Since this model requires an ability to detect electric stimuli, its application is restricted largely to marine chondrichthyans (sharks and their relatives). This model is further discussed and described in section 4.2.2.

Optical pumping – Several detailed theoretical models are proposed for effects of magnetic stimuli on pigments in the visual system of animals (see Johnsen and Lohmann 2005 for review). These light-based models propose that free electrons from excited visual pigments may interact with an ambient magnetic field and change information that is sent to the brain by the optic nerve. Work on birds has shown that neurons in visual processing regions of the brain are excited by magnetic field stimuli that are dependent on the wavelength of light that enters the eye (Semm et al. 1984, Semm and Demaine 1986). However, experimental evidence for magnetic optical pumping in marine species is lacking.

Evidence of magnetoreception has been reported for marine organisms ranging from microscopic bacteria to baleen whales. Specific evidence for the following major groups is discussed in sections below: elasmobranchs (section 4.2.2), marine mammals (section 4.2.3), sea turtles (section 4.2.4), other fishes (section 4.2.5), and invertebrates (section 4.2.6).

4.2.1.3. *Electroreception*

All living Chondrichthyans (the elasmobranch fishes [sharks, skates, rays] and the holocephali ratfishes) possess a unique sensory system known as the Ampullae of Lorenzini that functions to detect weak electric fields in their underwater environment (see section 4.2.2). Behaviorally, the electrosense in sharks and rays is now known to be used for orientation and approach to electric fields produced by biological and also anthropogenic sources (e.g. electric and galvanic fields). In addition to direct detection of electric stimuli, models now exist for the use of the electroreceptor system to detect, orient and possibly navigate to magnetic stimuli via induction (discussed in sections 4.2.1.2 and 4.2.2).

In addition to chondrichthyan fishes, some evidence of electroreception has been reported for other groups of fishes (e.g., lampreys, sturgeons, and some teleost fishes) and for decapod crustaceans. Specific evidence of electroreception for the following groups is discussed in

sections below: elasmobranchs (section 4.2.2), other fishes (section 4.2.5), and invertebrates (section 4.2.6).

4.2.1.4. *Potential Impacts to Marine Species from Anthropogenic EMFs*

The current understanding of potential impacts to marine species from anthropogenic EMFs is limited (Gill, et al. 2005). There are suggestions that if navigation is affected then migratory species may be slowed or deviated from their intended routes with subsequent potential problems for populations if they do not reach essential feeding, spawning or nursery grounds. On a more local scale species that use EMF for finding food may be confused and spend time hunting EMF that is non-biological and hence reducing daily food/energy intake. Species that use EMF to detect predators or conspecifics could unnecessarily alter their behavior, or this capability could be undermined by anthropogenic EMF sources. The consequence is that if enough individuals are affected then the population and communities that these species belong to may be adversely affected. Nevertheless, these impacts are all currently speculation and it is essential to gain direct evidence to assess if these potential impacts are real and of ecological significance. Potential impacts specific to each group of marine species are further discussed in the sections below.

4.2.2. Elasmobranchs

4.2.2.1 *Review of Existing Information*

Existing information provides strong evidence that elasmobranch fishes (sharks, skates, rays) can detect both electric and magnetic fields. This evidence is discussed below, followed by a discussion of elasmobranch species that are targeted for review in this report.

Evidence Basis for Sensitivity to EMFs

Evidence for sensitivity to EMFs comes from physiological, behavioral, and anatomical studies on numerous species in a wide range of families and orders within the Subclass Elasmobranchii. Table 4.2-1 provides a listing of elasmobranch species from US waters and around the world for which information on sensitivity to electric or magnetic fields has been reported. Sections below review this evidence for sensitivity in elasmobranchs.

Electroreceptor Anatomy and Physiology

All living elasmobranch fishes possess a unique electrosensory system known as the ampullae of Lorenzini. Although these unique sensory structures were first identified by Lorenzini in the 1600s, their fine structure, physiology and function were only recently studied in detail. This system is now known to consist of a large array of individual receptors that sense the environment for electric field stimuli. The electrosensory structure consists of a small sensory chamber attached to a single subdermal canal that is approximately 1mm in diameter and up to 10s of cm in length. Each ampulla contains receptor cells and is associated with branches of cranial nerves that form separate groups on each side of the head. Individual canals project from their respective ampulla and emerge at a skin pore on the surface of the head (and pectoral fins in most skates and rays). The canals are filled with a conductive and reactive gel that interacts with

Table 4.2-1

Listing of elasmobranch species for which information on sensitivity to electric or magnetic fields has been reported.

Species ^a	Common Name	US ? ^b	Sensitivity ^c	Sensory Range	Evidence Basis	Citation
Class Chondrichthyes, Subclass Elasmobranchii: sharks, skates, and rays						
Order Squaliformes, Family Squalidae: dogfish sharks						
<i>Squalus acanthias</i>	spiny dogfish, spurdog	US	none	n/a	Inconclusive results when exposed to EMFs from 36kV AC cable	Gill et al. 2009
Order Orectolobiformes, Family Ginglymostomatidae: nurse sharks						
<i>Ginglymostoma cirratum</i>	nurse shark	US	E	frequency: DC fields and AC fields <1.6 Hz	Behavioral	Johnson et al. 1984
Order Lamniformes, Family Lamnidae: mackerel sharks						
<i>Carcharodon carcharias</i>	white shark	US	E/M?	geomagnetic field/electric field sensitivity n/a	Behavioral/ observational/ anatomical/ theoretical	Klimley et al. 2002, Tricas 2001, Tricas and McCosker 1984
<i>Isurus oxyrinchus</i>	shortfin mako	US	E/M?	geomagnetic field/electric field sensitivity n/a	Behavioral/ observational	Klimley et al. 2002
Order Carcharhiniformes, Family Scyliorhinidae: cat sharks						
<i>Cephaloscyllium isabellum</i>	carpet shark	Not in US	E	2 μ V/cm	Physiological/ behavioral	Bodznick and Montgomery 1992, Yano et al. 2000
<i>Cephaloscyllium ventriosum</i>	swell shark	US	E	n/a	Behavioral	Tricas 1982
<i>Scyliorhinus canicula</i>	small-spotted cat shark	Not in US	E	0.01 to 0.1 μ V/cm	Behavioral/ physiological	Filer et al. 2008, Gill and Taylor 2001, Gill et al. 2009, Kalmijn 1966, Kalmijn 1971, Kimber et al. 2009, Pals et al. 1982a, Peters and Evers 1985
<i>Scyliorhinus torazame</i>	cloudy catshark	Not in US	E	0.2-10V and 0.1-5A, DC	Behavioral	Yano et al. 2000

Table 4.2-1. Listing of elasmobranch species for which information on sensitivity to electric or magnetic fields has been reported. (continued)

Species ^a	Common Name	US ? ^b	Sensitivity ^c	Sensory Range	Evidence Basis	Citation
Order Carcharhiniformes, Family Triakidae: hound sharks						
<i>Mustelus canis</i>	smooth dogfish	US	E	0.005 to 0.01 μ V/cm minimum threshold	Behavioral	Dawson et al. 1980, Kalmijn 1982
<i>Triakis semifasciata</i>	leopard shark	US	E	mean, maximum threshold of 9.64 \pm 10.28 V/m	Behavioral	Marcotte and Lowe 2008
<i>Triakis scyllium</i>	banded houndshark	Not in US	E	0.2-10V and 0.1-5A, DC	Behavioral	Yano et al. 2000
Order Carcharhiniformes, Family Carcharhinidae: requiem sharks						
<i>Carcharhinus falciformis</i>	silky shark	US	E	0.2-10V and 0.1-5A, DC	Behavioral	Yano et al. 2000
<i>Carcharhinus leucas</i>	bull shark	US	E	current <10 μ A	Behavioral	Collin and Whitehead 2004, Whitehead 2002
<i>Carcharhinus melanopterus</i>	blacktip reef shark	Not in US	E	0.2-10V and 0.1-5A, DC	Behavioral	Haine et al. 2001, Yano et al. 2000
<i>Carcharhinus plumbeus</i>	sandbar shark	US	E/M	median: 0.0303 μ V/cm; 25-100 μ T	Behavioral/ anatomical/ theoretical	Brill et al. 2009, Kajiura 2001b, Kajiura and Holland 2002, Meyer et al. 2005
<i>Galeocerdo cuvier</i>	tiger shark	US	none	n/a	None: no behavioral response to 0.2-10V and 0.1-5A, DC	Yano et al. 2000
<i>Prionace glauca</i>	blue shark	US	E/M?	5 nV/cm; geomagnetic field	Behavioral/ observational	Heyer et al. 1981, Kalmijn 1982, Klimley et al. 2002
<i>Triaenodon obesus</i>	whitetip reef shark	Not in US	E	0.2-10V and 0.1-5A, DC	Behavioral	Yano et al. 2000
Order Carcharhiniformes, Family Sphyrnidae: hammerhead sharks						
<i>Sphyrna lewini</i>	scalloped hammerhead	US	E/M	0.01 μ V/cm; 25-100 μ T	Behavioral/ observational/ anatomical/ theoretical	Kajiura 2001b, Kajiura and Fitzgerald 2009, Kajiura and Holland 2002, Klimley 1993, Marcotte and Lowe 2008, Meyer et al. 2005
<i>Sphyrna tiburo</i>	bonnethead	US	E	min: < 1 nV/cm; median: 47 nV/cm	Behavioral/ anatomical/ theoretical	Kajiura 2001b, Kajiura 2003

Table 4.2-1. Listing of elasmobranch species for which information on sensitivity to electric or magnetic fields has been reported. (continued)

Species ^a	Common Name	US ? ^b	Sensitivity ^c	Sensory Range	Evidence Basis	Citation
Order Torpediniformes, Family Torpedinidae: torpedo electric rays						
<i>Torpedo californica</i>	Pacific electric ray	US	E	n/a	Behavioral	Lowe et al. 1994
Order Rajiformes, Family Platyrhynidae: thornbacks						
<i>Platyrhinoidis triseriata</i>	thornback	US	E	n/a	Physiological	Bullock et al. 1993
Order Rajiformes, Family Rajidae: skates						
<i>Amblyraja radiata</i>	thorny skate	US	E	n/a	Anatomical/ theoretical	Raschi and Adams 1988
<i>Dipturus laevis</i>	barndoor skate	US	E/M?	n/a ; geomagnetic field	Anatomical/ theoretical	Camperi et al. 2007, Tricas 2001
<i>Leucoraja erinacea</i>	little skate	US	E	1-20 $\mu\text{V}/\text{cm}$	Physiological/ behavioral/ anatomical	Bodznick et al. 1992, Bratton and Ayers 1987, Duman and Bodznick 1996, Fields et al. 2007, Hjelmstad et al. 1996, Lu and Fishman 1994, Montgomery and Bodznick 1993, New 1990, New 1994, Salyapongse et al. 1992
<i>Leucoraja ocellata</i>	winter skate	US	E	n/a	Physiological/ behavioral	Bratton and Ayers 1987, Lu and Fishman 1994, New 1994
<i>Raja clavata</i>	thornback ray	Not in US	E/M	0.01 $\mu\text{V}/\text{cm}$; 0.35 G: induced field = 0.16 mV/cm	Behavioral/ physiological	Broun et al. 1979, Brown and Ilyinsky 1978, Gill et al. 2009, Kalmijn 1966, Kalmijn 1971, Montgomery 1984
<i>Raja eglanteria</i>	clearnose skate	US	E	frequency of 0.5 and 7 Hz, varied by developmental stage	Behavioral/ physiological	Sisneros et al. 1998
Order Myliobatiformes, Family Dasyatidae: whiptail stingrays						
<i>Dasyatis sabina</i>	Atlantic stingray	US	E	0.0075 to 9.2 $\mu\text{V}/\text{cm}$; frequency 0.1 to 8 Hz	behavioral/ anatomical/ physiological	Bedore and Kajiura 2009, Blonder 1985, Blonder and Alevizon 1988, McGowan and Kajiura 2009, Sisneros and Tricas 2000, Sisneros and Tricas 2002a
<i>Himantura granulata</i>	mangrove whipray	Not in US	E	n/a	Theoretical	Haine et al. 2001

Table 4.2-1. Listing of elasmobranch species for which information on sensitivity to electric or magnetic fields has been reported. (continued)

Species ^a	Common Name	US ? ^b	Sensitivity ^c	Sensory Range	Evidence Basis	Citation
Order Myliobatiformes, Family Urolophidae: round stingrays						
<i>Urobatis halleri</i>	round stingray	US	E/M	0.005 to several $\mu\text{V}/\text{cm}$	Behavioral/ physiological	Bullock et al. 1993, Kalmijn 1982, Tricas and New 1998, Tricas et al. 1995
Order Myliobatiformes, Family Myliobatidae: eagle rays						
<i>Myliobatis californica</i>	bat ray	US	M?	geomagnetic field	Theoretical/ observational	Klimley et al. 2005
Order Myliobatiformes, Family Rhinopteridae: cownose rays						
<i>Rhinoptera bonasus</i>	cownose ray	US	E	7.5 nV/cm	Anatomical/physiological: ampullary pore distribution and response to electric field	Bedore and Kajiura 2009
<i>Rhinoptera bonasus</i>	cownose ray	US	E	7.5 nV/cm	Anatomical/ physiological	Bedore and Kajiura 2009

^a Species listed alphabetically within family

^b US = occurs in US waters; not in US = does not occur in US waters

^c M = magnetosensitivity; E = electrosensitivity; none = no sensitivity reported

external electric fields and delivers a voltage potential to the ampullary chamber. This potential stimulates the receptor cells and associated neurons that convey sensory information to the brain.

The separation of the sensory ampulla chamber and pore by the intervening canal makes these structures sensitive to voltage gradients within their environment detected as voltage difference along the length of the canal. As a result, longer canals are more sensitive than short canals to weak field gradients. Laboratory neurophysiology experiments on stingrays show that electrosensory primary afferent neurons respond to applied uniform voltage gradients $\leq 20\text{nV/cm}$ (Tricas and New 1998). These receptors are phasic in their response and a stationary animal will adapt within a few seconds to a constant, unchanging electric field. They show robust responses to the rapid onset or offset of an electric field stimulus but are most sensitive to varying sinusoidal fields delivered at frequencies from 1-10 Hz (Andrianov et al. 1984, Montgomery 1984, Tricas and New 1998).

These neurophysiology experiments on single sensory neurons show sensitivity to very weak electric fields in sea water and are consistent with observed responses on whole and behaving animals. Spotted dogfish and skates show cardiac responses to low frequency pulsed fields as low as 10nV/cm (Kalmijn 1966). Round stingrays can behaviorally discriminate the polarity of artificial DC uniform fields and orient to fields at intensities as low as 5nV/cm (Kalmijn 1982). Other studies show orientation responses to small electric dipoles in seawater at thresholds of 10 – 30 nV/cm at distances up to about 0.5 m (Kalmijn 1971, 1982; Kajiura and Holland 2002; Kajiura and Fitzgerald 2009).

Mechanisms of Magnetoreception in Elasmobranch Fishes

Elasmobranch fishes either detect magnetic fields using their exquisite and highly sensitive electrosensory system, or possibly by a yet-to-be-described magnetite receptor system (see section 4.2.1.2). Kalmijn (1974, 1981) developed an electromagnetic induction model for the elasmobranchs based on their electrosensory system. The main premise is based upon Faraday's law in which a conductor that moves through a magnetic field experiences an electromotive force (voltage). In the active mode, a shark that swims across the horizontal component of the earth's magnetic field lines experiences separation of charges across the top and bottom of the head in a vector that depends on field strength, swimming speed and swimming direction. A weak current flow path results through the head and returns via the surrounding conductive seawater such that the stimulus features are constant until the swimming direction, velocity or magnetic field features change. Thus the induced electric signature on the animal body could provide derived information to the electrosensory system about the direction of the ambient magnetic field. In the passive mode, a shark that drifts in oceanic current experiences a horizontal electric field across the body as the water mass crosses through the vertical magnetic field lines. Such a mechanism could be useful for detection of changes in current patterns or tide velocity and direction. Criticisms of these basic models are proposed (e.g. Paulin 1995, Kirschvink 1989, Kirschvink et al. 2001) but little experimental work on either mode exists (e.g. Kalmijn 1982, 1988).

Many marine animals are known to sense, respond or orient to external magnetic fields, but evidence for magnetic orientation by behaving sharks and rays are few. Neurophysiology experiments on the electrosensory neurons in skates have demonstrated responses to strong and

varying magnetic stimuli that are inductively coupled to the electroreceptors (Andrianov et al. 1974, Akoev et al. 1976, Brown and Ilyinsky 1978). The minimum rate of magnetic field variation that elicited a response was 200 $\mu\text{T}/\text{sec}$. Behavior studies in the laboratory show that stingrays (Hodson 2000) and juvenile sharks (Meyer et al. 2005) could be conditioned to respond to the presence or absence of imposed magnetic fields, and the response reversibly ablated in the former species if magnets were placed near the olfactory epithelium. The movements of adult hammerhead sharks were tracked in Mexico between midwater seamounts separated by a distance of about 20 km. The patterns of repeated movements were strongly correlated with changes in magnetic field intensity (magnetic field rate of change of 37 nT/km) along the migration route (Klimley 1993). This behavior is consistent with magnetic orientation and possibly navigation behavior, but the mechanism remains to be determined. Thus, although it is clear that free swimming elasmobranchs can orient to ambient electric and magnetic field stimuli, definitive experiments are needed to resolve the relative contribution of the electrosense and putative direct magnetosense.

Functional Roles for the Electrosense

In addition to providing potentially important cues for environmental orientation and navigation behaviors, the electrosense is known to serve three other functions in sharks and rays. First, elasmobranch fishes detect weak bioelectric fields produced by their natural prey. In the laboratory, catsharks and skates show directed attacks towards small flounder prey that are buried in the sand, and can locate the prey when it is concealed within a buried agar chamber that is permeable to its bioelectric field but not its odor (Kalmijn 1971). In the field, swell sharks in their natural habitat use bioelectric cues to capture prey during normal nocturnal feeding (Tricas 1982). In addition, these and several other elasmobranchs show natural orientation responses toward buried or concealed dipole electrodes (that simulate cryptic prey) when motivated to feed (Kalmijn 1971, 1982, Tricas 1982, Kajiura and Holland 2002, Blonder and Alevizon 1988). These studies demonstrate that sharks and rays rely heavily upon their electrosense to locate food resources at close range during the night or daytime, especially when prey are not in the field of view. The effective distance of this sense under natural conditions is up to a few 10s of cm from the source. Second, the electrosense is involved in detection and location of other individuals.

Studies on the round stingray, *Urobatis halleri*, have extended the role of electroreception for elasmobranch fishes to include social interactions during reproduction (Tricas et al. 1995). During the mating season, individuals of both sexes use their electrosense to locate buried females from distances of 0.1 - 1 m. Males benefit by locating potential mates, and mated females by locating a group refuge. Thus, electrosensory cues may enhance reproductive success for both sexes. The third demonstrated function of the elasmobranch electrosense is for the detection of bioelectric fields produced by potential predators. The electroreceptors of embryonic and juvenile clearnose skates, *Raja eglanteria*, detect weak bioelectric stimuli produced by potential egg predators like elasmobranchs, teleost fishes, marine mammals and molluscan gastropods (Sisneros et al. 1998). Phasic electric stimuli of 0.1 to 1 Hz are also known to interrupt the ventilatory activity of newborn catsharks, *Scyliorhinus canicula* (Peters and Evers 1985). These electrosensory-mediated behaviors may represent an adaptive response during early life history to avoid detection by predators and enhance survival.

Preliminary Listing of Elasmobranch Species

Based on strong evidence for sensitivity to both electric and magnetic fields, all species of elasmobranchs in coastal waters (bottom depth <200 meters) of the continental US were targeted for review in this report. Appendix Table C-1 provides summarized sensitivity findings in a phylogenetically ordered listing of the 127 elasmobranch species that occur in coastal waters of the continental US (Nelson et al. 2004). This listing also includes elasmobranchs from elsewhere throughout the world oceans for which information on sensitivity to electric or magnetic fields has been reported. Thus, findings on sensitivity to electric or magnetic fields can be compared among related species within this table. As indicated in Appendix Table C-1, the smalltooth sawfish (*Pristis pectinata*), an endangered species, is the only federally listed elasmobranch in US waters.

4.2.2.2 Effects of EMFs from Undersea Power Cables

Comparison of Expected EMF Levels to Reported Sensitivities

The sensitivity of elasmobranch fishes to electric and magnetic stimuli described above can be compared to those associated with underwater cable systems as modeled in Section 4.1.3. Several empirical studies show that sharks and rays are sensitive to dipole and uniform fields with gradients as low as 1-5 nV/cm (=1-5 x10⁻⁷ V/m). Thus these measurements provide a starting point to predict general behavioral responses as animals encounter electric fields associated with power transmission cable systems.

AC Cable Systems

Power generated by offshore wind facilities is often transmitted to onshore sites via AC systems that produce an alternating magnetic field external to the cable at frequencies of 50-60 Hz. This varying magnetic field can act upon local streaming water currents to induce an electric field within the water column or the body of a swimming fish. The electrosensory primary neurons in elasmobranch fishes show highest sensitivity to alternating electric fields from 1-10 Hz but also a broad response bandwidth from 0.01-25 Hz in which much stronger field intensities (up to 10x or greater) are required to stimulate the electrosensory system (summarized in New and Tricas 1997, Bodznick et al. 2003). Thus, based upon neurophysiological studies the direct sensitivity to weak time varying 60 Hz electric fields is very low to nil. Likewise, behavioral responses in several elasmobranch species were best to DC and modulated electric fields at frequencies up to 8 Hz (Kalmijn 1974). Although AC power frequencies are above these reported sensitivity ranges for sharks and rays, the magnitude of induced AC fields in the modeled system (Table 4.1-5) may be detected at close distances to the cable. In addition, there are a few experimental observations from the mesocosm-based COWRIE 2.0 EMF study that the distribution and behaviors of free swimming elasmobranchs changed when buried AC cables were powered (Gill et al. 2009). Some bottom dwelling small-spotted catsharks (*Scyliorhinus canicula*) were found nearer to the zone where the magnetic field was highest (1-2 m from the cable) when the cable was powered compared to when it was not powered. Indications of increased movement by catsharks and thornback rays (*Raja clavata*) when the cable was powered were also found. Clearly more work is needed to identify whether these responses were mediated by the electrosense to AC fields, a putative magnetosense or both.

DC Cable Systems

Sharks and rays are most sensitive to standing DC electric fields that the animal encounters as it swims through its aquatic environment. These fields can be directly produced from power sources or induced by standing magnetic fields.

Several forms of monopole power systems currently exist that involve various cable and electrode configurations. In the case of the monopolar DC cable system with a single power cable and the return current path that flows through the ocean (now rarely used), there can be a resultant direct electric field of 20 mV/cm (Section 4.1.3.2) that is far above the sensory thresholds known for elasmobranch fishes. While no direct behavioral data are provided, it is expected that sharks and rays would detect, respond and possibly show aversive behaviors (avoidance) to these relatively strong electric fields (Cliff and Dudley 1992, Yano et al. 2000). Clearly more work is needed to determine the field properties at distance and the effects on different species of sharks and rays.

Bipole or monopole (with a return cable) DC cable transmission systems are likely to become more common in the future as larger wind projects are constructed farther from shore. These configurations should have no direct electric current path in seawater. However, power cables can produce significant standing magnetic fields that extend in the water column which can induce electric fields in the water column and swimming fishes. Induced DC electric fields modeled for a sea current flowing at 5 knots above a buried DC submarine cable (Table 4.1-4) could be detected by a drifting elasmobranch fish at distances of several meters above and to the side of a cable. Likewise, an active shark swimming in still water would detect the induced electric field as it approached the cable. However, the perception of an induced electric field by an electrosensitive shark is complex and dependent upon several factors such as cable characteristics, electric current, cable configuration, cable orientation relative to geomagnetic field, the swimming direction of the animal, local tidal movements, etc. It should be noted that the shark is capable of detecting the induced electric field from the current flow of the ocean even if no cable is present. Thus it is not possible to predict distances and directions of response without detailed information associated with each location. Nonetheless, in the field swimming stingrays will alter their course when they encounter a non-uniform DC field, perhaps to correct their swimming path in relation to induced electric fields in drifting water currents that pass through the earth's magnetic field (Kalmijn 1988). It is possible that the swimming path of other elasmobranch species that encounter electric fields associated with buried power cables may be affected.

Direct Magnetoreception

As described above, it is possible but not yet demonstrated, that sharks and rays may directly detect magnetic field by a putative but yet to be described magnetite-based receptor organ. If this turns out to be the case, then sharks and rays would have a second sensory system that is influenced by standing magnetic fields associated with underwater cables. Although a few studies show behavioral responses to experimentally applied magnetic fields (e.g. Meyer et al. 2005) the precise mechanism for these behaviors (direct magnetoreception vs. induced electroreception) is still in debate (Johnsen and Lohmann 2005). Of note, the predicted field intensity needed to stimulate a single domain magnetite-based sensor could be as low as 1-10 nT (Kirshvink et al. 2001) and the predicted organization of magnetoreceptor cells are modeled

(Walker 2008). The reader is referred to section 4.2.3 for a discussion of magnetoreception in bony fishes as similar interpretations may apply to sharks and rays.

4.2.2.3 *Potential Impacts to Elasmobranchs*

The assessments of elasmobranch responses to cable electromagnetic fields are based on a small number of data sets and the interpretations are limited. Responses to electric and magnetic stimuli are reported for only a few of the approximately 1000 living elasmobranch fishes, thus variation is expected among species, sex and age classes. In addition, anthropogenic electromagnetic stimuli associated with offshore wind facilities may affect context specific behaviors that are dependent on season and habitat. Unfortunately, almost no data exist on the interactions of natural elasmobranch populations and anthropogenic electromagnetic stimuli, thus we can only speculate as to what effects power cable systems may have on them.

Migrations

Many sharks and rays are migratory and make seasonal movements along coastlines or offshore waters. Encounters with submarine power cables may temporarily affect their migration pathway over short distances. The detection of a magnetic anomaly produced by the cable at the seafloor might not necessarily be adverse in that it could provide an easily recognizable topographic landmark.

Non-Migratory Species and Habitat Use

Many species of sharks and rays swim over large home ranges each day, whereas others are sedentary and live in restricted areas. Resident populations that inhabit areas near cable tracks may be attracted, repelled or unaffected by the presence of power cables. As a result, distributions and swimming behaviors of resident elasmobranch populations may be affected by magnetic fields from power cables. No scientific studies have been conducted that explore these alternative possibilities however.

Feeding Behavior

The electrosense of sharks and rays provides an important means of detecting and locating prey at night or that are hidden in the bottom during the day. The affect of electrosensory-mediated feeding success near strong ambient magnetic fields from power cables is unknown. Available data suggest, however, that prey detection and attack is focused on sources of low frequency (i.e., <10 Hz) fields; the importance of static electric and magnetic fields is unknown.

Reproductive Behavior

Many elasmobranch fishes engage in mating behavior at specific geographic locations along the US coast. In addition, the electrosense is used by rays in the detection of mates for mating. The effect of power cables on elasmobranchs in reproductive areas is not known.

Nursery Grounds

The young of many sharks and rays spend their early life in shallow coastal bays or estuaries where food is abundant and predators are few. Cable installations through these areas may affect the behavior or distribution of juvenile elasmobranchs although this is an untested concern.

To summarize, the above examples emphasize that introduced EM fields can affect many aspects of the daily behaviors of elasmobranch fishes. Since the electrosense functional distance is a few 10s of centimeters in their natural environment, any emission from a cable may provide anomalous cues for these species. Many species actively search the seabed for relevant cues so understanding the potential influence of emissions and likelihood of encounter is very important in regions close to the cables. Arguments that cable runs contribute to a small part of the overall area in the home range or migration paths and would not, therefore, be of importance are speculative. There is no evidence to date that bottom swimming fish will swim up into the water column to avoid a power cable on the bottom rather than turn to inspect it. Further, this conjecture cannot be applied to the many obligate benthic species and juveniles that depend on the seabed for food and refuge.

4.2.2.4 *Priority Species by Region*

Based on existing evidence of sensitivity, all elasmobranchs in US coastal waters (127 species) were identified as “priority species” for the final level of assessment using natural history attributes. Natural history characteristics for these species are provided in Appendix Table C-2 and their distribution within BOEMRE planning areas is shown in Table 4.2-2 and Appendix Tables C-3 and C-4.

Natural history characteristics provide information about the probability that a species will encounter EMFs from undersea cables. For example, demersal species, including those that are strictly benthic and also those considered benthic-pelagic, live in close association with the seafloor where the highest EMF levels from undersea cables would be encountered. It has been suggested that electroreceptive species that use their electric sense to detect prey buried within the bottom substrate by sensing their low frequency AC fields may be attracted by EMFs from cables and pursue the fields as if they were prey items (Gill et al. 2005). Recent experimental evidence shows that benthic catsharks are either unable to tell the difference between natural and artificial electric fields or show no preference for either (Kimber et al. 2011). A species’ distribution relative to the coastline and to depths in which offshore renewable energy facilities are most likely to be constructed is also important. Near-shore and coastal species with bottom depth distributions to less than 100 meters are more likely to encounter cables than are those species in deeper waters, especially those occurring off the continental shelf in depths greater than 200 meters. A third important attribute is the geographic distribution of a species, which indicates whether that species is known to occur in the area of a particular proposed project (Appendix Table C-4).

Species with the highest conservation status or fisheries management status must be given top priority in the process of assessing potential impacts. The smalltooth sawfish is the only federally listed elasmobranch, and within its range (centered in southern Florida), this species would be likely to encounter cable EMFs based on its benthic habits and coastal distribution. Also, those species for which Essential Fish Habitat (EFH) has been designated are identified in

Table 4.2-2

Regulatory Status and Geographic Distribution of Elasmobranch Order in US Waters Within BOEMRE Planning Areas and Regions of Alaska.

Order	No. of Families	No. of spp.	No. of ESA ^a	No. of EFH ^b	No. of spp. by Geographic Region ^c													
					North Atlantic	Mid Atlantic	South Atlantic	Straits of Florida	Eastern Gulf of Mexico	Central Gulf of Mexico	Western Gulf of Mexico	Southern California	Central California	Northern California	Washington/Oregon	Alaska (Aleutian Islands)	Alaska (Frontier)	Alaska (Northslope)
Hexanchiformes	2	5	0	3	1	2	2	0	2	2	2	2	1	1	1	0	0	0
Squaliformes	5	12	0	1	6	7	4	3	5	5	5	1	2	1	1	1	1	0
Squantiformes	1	2	0	1	1	1	1	1	1	1	1	1	1	1	1	1	0	0
Heterodontiformes	1	1	0	0	0	0	0	0	1	1	1	1	1	0	0	0	0	0
Orectolobiformes	2	2	0	2	2	2	2	2	2	2	2	0	0	0	0	0	0	0
Lamniformes	6	13	0	9	7	8	8	8	4	4	4	8	4	4	5	3	1	0
Carcharhiniformes	5	38	0	25	12	21	21	23	19	19	18	13	9	8	5	1	0	0
Torpediniformes	2	3	0	0	1	2	2	2	1	1	1	1	1	1	1	0	0	0
Pristiformes	1	2	1	0	0	1	1	1	2	2	2	0	0	0	0	0	0	0
Rajiformes	3	29	0	10	9	8	4	4	5	5	5	8	7	5	5	10	4	0
Myliobatiformes	6	20	0	0	5	12	12	12	8	8	10	6	5	5	2	0	0	0
Total (11 orders):	34	127	1	51	44	64	57	56	50	50	51	41	31	26	21	16	6	0

^a ESA = Endangered Species Act

^b EFH = Essential Fish Habitat

^c refer to Figure 1.0-1 for planning areas; citations for range data provided in Appendix Table C-3.

Appendix Table C-2. Additional natural history attributes such as species movement (whether they are migratory or non migratory) or changes in distribution patterns related to life stage or season are provided for federally listed species and managed species in Appendix Table C-2. Factors that help to determine the risk for potential impact to elasmobranchs from EMFs vary greatly at each level of consideration including (1) physical factors (e.g., cable system attributes that determine EFH levels), (2) biological factors (e.g., sensitivity levels for various species), and (3) ecological factors (e.g., natural history attributes for various species). Thus, project and site specific analyses of potential EMF impacts to local fish species are essential. A case study that addresses considerations for assessing potential EMF effects is provided below for a representative elasmobranch species (sandbar shark).

4.2.2.5 Case Study of the Sandbar Shark *Carcharhinus plumbeus*

The sandbar shark (*Carcharhinus plumbeus*; Figure 4.2-1) is a large coastal species (adults approximately 2 m in length) that occurs in U.S. waters along the east coast, Gulf of Mexico and Hawaii. It is a common inhabitant of shallow coastal waters and estuaries where it swims over soft bottoms and near reefs to feed on fishes and large invertebrates. It is most common in depths of 20-60 m but also occurs in deeper offshore waters up to 250 m.



Figure 4.2.1. Sandbar Shark

This species is highly migratory, forms large schools and travels over distances of several hundred kilometers each year between summer and wintering grounds (Collette and Klein-MacPhee 2002). Adult females move from the south into north estuaries such as Chesapeake Bay in late spring to bear live pups and then move offshore to feed (Grubbs et al. 2007). Newborn pups remain in the estuaries to feed throughout their first summer and return to estuaries and associated coastal waters each summer for periods up to 10 years (Sminkey 1994 as cited in Grubbs et al. 2007).

Subadults then join the main adult population in coastal waters and reach sexual maturity at about 15 years of age. Sandbar shark populations in the U.S. experienced heavy fishing pressure in recent decades and are now managed by the National Marine Fisheries Service (NMFS) under the Fishery Management Plan for Atlantic Tuna, Swordfish and Sharks. NMFS (2010b) identified several estuarine and nearshore nursery areas in the mid-Atlantic as Habitat Areas of Particular Concern (HAPC: Figure 4.2-2).

The complex life history, wide dispersion, highly migratory behavior and use of shallow waters for nursery grounds make the sandbar shark a good example species for encounters with power transmission cables from offshore wind generation platforms on the coast of North America. On the eastern seaboard, the migratory paths of adults and juveniles involve northward movements in early spring and southward movements late summer. These routes could transect westerly directed transmission cables from offshore wind farms. While adults, juveniles and subadults are

all active in shallow waters near the coastline, distributions of this species can extend hundreds of km seaward on the southern and northern regions of the continental shelf. The relative

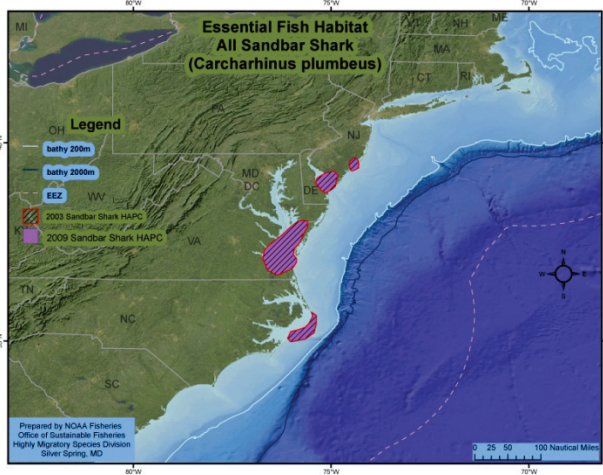

Figure 4.2-2. Sandbar Shark HAPC (NMFS 2010b)

restricted movements of juvenile sharks inside estuaries would also increase the frequency of encounters with offshore power cables that traverse the shoreline.

This species shows several behaviors that would bring them in close proximity to submarine cables on the ocean substrate. First, juvenile and adults sandbar sharks spend much of their time swimming near the bottom. Second, their diet consists of bottom dwelling marine fish and invertebrates. Sandbar shark pups in estuaries feed on soft blue crabs and mantis shrimp and also small fish such as flounder and drum that live close to, upon or within the bottom substrate (Medved and Marshall 1981, Ellis 2003).

Adults and juveniles in coastal waters feed largely on skates (batoid rays that live on the soft bottom) and teleost fish that live near or on the bottom such as flatfish, goosefish and hake (Stillwell and Kohler 1993). Thus, the tendency of this species to swim, associate and feed near the bottom increase the probability of cable encounters. Other behaviors that relate to details of social behavior, mating and reproduction in relation to electromagnetic stimuli remain to be determined.

While much is known about the life history and habits of sandbar sharks, very little is known on their responses to electric or magnetic fields. The distribution of electroreceptor pores is unremarkable with approximately even numbers on the dorsal and ventral surface of the head (Kajiura 2001). Orientation experiments on free-swimming juveniles to an electric dipole stimulus that simulated bioelectric fields of prey show that sharks respond to prey at distances of approximately 30 cm (1 foot) where field intensities are as low as 0.4 nV/cm as measured to the nearest side of the head (Kajiura and Holland 2002). Median field intensity associated with orientation behavior was 0.025 μ V/cm. These observations are similar to minimum stimulus levels that evoke orientation behaviors or physiological responses from electroreceptor neurons in other elasmobranch species (Peters et al. 2007). It is also significant, that these distances of orientation do not provide information on detection or perception of the field by a shark, but these are undoubtedly lower.

Information on the response of sandbar sharks to magnetic stimuli is also limited. Free swimming juveniles in large holding tanks can be conditioned to detect pulsed DC magnetic fields at intensities of 25-100 μ T or from 0.7 – 2.8 times the total ambient magnetic field (Meyer et al. 2005). The mechanism for this response to varying magnetic stimulus, however, remains to be determined. As outlined in Section 4.2.1, two primary models exist for magnetic detection in sharks. The induction model proposes that detection is mediated by the induction of an electric field by the movement of a shark through the earth's magnetic field (Kalmijn 1974). Although

there is evidence for putative magnetoreceptors in the bony fish olfactory system (Walker et al. 1997), no parallel system has yet been identified in any shark although one may exist.

Ocean currents create widespread and localized electric fields by the movement of charges through the earth's magnetic field. These can be predictable as in tidal streams and can occur in the shallow waters during tidal ebb and flow. The electric fields are relatively small (on the order of 0.05-0.5 $\mu\text{V}/\text{cm}$, Kalmijn 1982). Specific values of the electric field have been measured in the English Channel by Enger at about 0.3 $\mu\text{V}/\text{cm}$ (Poléo, et al. 2001). Higher values are measured over muddy seabeds (0.75 $\mu\text{V}/\text{cm}$) (Pals, et al. 1982) and during geomagnetic storms (0.6 - 1.25 $\mu\text{V}/\text{cm}$) (Brown, et al. 1979).

Induced electric fields are also produced as the result of submarine cables as described in 4.1.3.2. An example of the electric field that results from a water current that moves parallel to a submarine DC cable buried 1 m below the substrate is shown in Table 4.1-4 and Appendix Table B-5. Given the several reports of orientation to fields of 1 - 5 nV/cm (= 1.0 - 5.0x10⁻⁷ V/m) discussed above, it is apparent that sharks should be able to detect induced electric fields created by the flow of water currents through the earth's magnetic field and the additional magnetic field from DC submarine cables. Beyond about 5 m from the cables the induced electric field from the cables would be similar to or less than that created by the earth's magnetic field ~ 50 μT . While it is possible that sharks may detect disturbances at greater distance, this remains to be determined. Note that the field intensity encountered by a swimming shark increases by an order of magnitude when the water current flow is perpendicular to a DC cable (Appendix Table B-6). The induced electric fields estimated to be intercepted by swimming sharks of various sizes swimming above an AC cable are provided in Table 4.1-5 and Appendix Table B-3. These also show induced electric field gradients well above those of the known detection thresholds for elasmobranch fishes that could evoke approach or avoidance behaviors.

Conclusion

Sandbar shark are a federally managed species whose populations in the US have experienced heavy fishing pressure in recent decades. These sharks inhabit shallow coastal waters which provide essential feeding and nursery grounds. They live and feed close to the seafloor and use a well-developed electrosensory system to assist in locating their prey. Studies indicate that sandbar shark also respond to magnetic stimuli. A magnetic sense may assist with seasonal migratory movements of adults and juveniles through coastal waters along the eastern seaboard. Thus, this combination of sensory capabilities and natural history attributes makes the sandbar shark a good example species for potential responses to power transmission cables from offshore wind generation facilities on the US East Coast. Despite these attributes and evidence for sensory thresholds that overlap with expected EMF levels from undersea power cables, the information necessary to understand the nature of any response and resulting consequences to individuals or populations of sandbar shark is lacking. Interference with feeding or some level of interruption to migratory movements are each plausible consequences; but study of shark interactions with undersea cables is needed to determine whether these currently speculative consequences may occur. Any potential effects would depend upon project and site-specific factors related to both the level of EMFs and the ecology of shark populations in proximity to the cable.

4.2.3. Other Fishes

4.2.3.1 Review of Existing Information

Existing information provides convincing evidence that a variety of fishes in addition to elasmobranchs (see section 4.2.2) can detect electric or magnetic fields, or both. This evidence is discussed below, followed by a discussion of fish species that are targeted for review in this report.

Evidence Basis for Sensitivity to EMFs

Evidence for sensitivity to EMFs comes from physiological, behavioral, and anatomical studies on fish species in a wide range of families and orders. Table 4.2-3 provides a listing of species from US waters and relevant groups around the world for which information on sensitivity to electric or magnetic fields has been reported (see also Appendix C-11). Several biological effects studies have reported responses of fish embryos or eggs to magnetic fields (Table 4.2-3). These studies involved high intensity fields, beyond the range of those expected from undersea cables, and are not discussed further herein. The following sections review electroreception and magnetoreception in non-elasmobranch fishes.

Electroreception

Electroreception is common in non-teleost fishes (Bullock 2005, Collin and Whitehead 2004). All living chondrichthyans [Elasmobranchii and Holocephali (ratfishes)] possess ampullae of Lorenzini, a highly sensitive electrosensory system described in section 4.2.2.1. Petromyzontiformes (lampreys) and Acipenseriformes (sturgeons) are also known to have an electric sense, and include species that inhabit US coastal waters. Electroreception is also reported for two groups of teleost fishes that are found in US waters. Siluriformes (catfish) are known to have electrosensory organs (Bullock 2005, Collin and Whitehead 2004), and responses to electric fields have been reported in Anguilliformes (freshwater eels; Table 4.2-3). In contrast to other groups listed above, equivocal evidence for Anguilliformes may suggest the absence of a highly sensitive and specialized electric sense (Bullock 2005).

Sensory organs for electroreception in fishes are classified as either ampullary or tuberous (Bullock 2002). These two types of receptor systems differ in their cellular morphology, and ampullary receptors are reportedly tuned to lower frequency fields (<0.1 to 25Hz), while tuberous receptors are tuned to higher frequency fields (50 to >2000 Hz; New 1997 as cited in Collin and Whitehead 2004). Tuberous receptors are only known in two teleost orders of freshwater electric fishes (Gymnotiformes in South America, Mormyriiformes in Africa; Bullock 2002). Ampullae of Lorenzini or similar organs have been found in elasmobranchs, ratfishes, lampreys, sturgeons, and catfishes (“Ampullae of teleosts” in catfishes; Bullock 2002). These ampullary organs are discussed in section 4.2.2.1.

Functional roles for electroreception in these fish taxa are thought to be similar to those described for elasmobranchs. Behavioral studies suggest that prey detection is the primary role of the electric sense in fishes (Collin and Whitehead 2004). Basov (1999) reported feeding responses to 50-Hz electric fields for several species of sturgeon, and both physiological and behavioral responses to fields in the range of those produced by prey items are reported for ratfishes (Table 4.2-3). Other potential roles for the electric sense include predator detection and

Table 4.2-3

Marine fish species (non-elasmobranch) for which information on sensitivity to electric or magnetic fields has been reported.

Species ^a	Common Name	US? ^b	Sensitivity ^c	Sensory Range	Evidence Basis	Citation
Superclass Agnatha, Class Cephalaspidomorphi, Order Petromyzontiformes, Family Petromyzontidae: lampreys						
<i>Lampetra fluviatilis</i>	European river lamprey	Not in US	E	0.1 to 20 $\mu\text{V}/\text{cm}$	physiological/ anatomical	Akoev and Muraveiko 1984, Fritzsche et al. 1984, Muraveiko 1984
<i>Lampetra tridentate</i>	Pacific lamprey	US	E	0.1 $\mu\text{V}/\text{cm}$ to 20 $\mu\text{V}/\text{cm}$	physiological	Bodznick and Northcutt 1981
<i>Petromyzon marinus</i>	sea lamprey	US	E	1 to 10 mV/cm	physiological/ behavioral/ anatomical	Bodznick and Preston 1983, Chung-Davidson et al. 2004, Chung-Davidson et al. 2008, Kishida et al. 1988, Koyama et al. 1993
Class Chondrichthyes, Subclass Holocephali, Order Chimaeriformes, Family Chimaeridae: shortnose chimaeras						
<i>Hydrolagus coliei</i>	spotted ratfish	US	E	0.2 $\mu\text{V}/\text{cm}$, 5 Hz	physiological/ behavioral/ anatomical	Fields 1982, Fields and Lange 1980, Fields et al. 1993
Class Actinopterygii, Subclass Chondrostei, Order Acipenseriformes, Family Acipenseridae: sturgeons						
<i>Acipenser gueldenstaedtii</i>	Russian Sturgeon	Not in US	E/M	0.2-6 mV/cm, 1.0-50 Hz	behavioral/ observational/ theoretical	Basov 1999, Gertseva and Gertsev 2002
<i>Acipenser ruthenus</i>	Sterlet	Not in US	E	0.2-6 mV/cm, 1.0-50 Hz	behavioral	Basov 1999
<i>Scaphirhynchus platyrhynchus</i>	shovelnose sturgeon	Not in US	E	<0.2 $\mu\text{V}/\text{cm}$ at 4 cm	physiological	Teeter et al. 1980

Table 4.2-3. Marine fish species (non-elasmobranch) for which information on sensitivity to electric or magnetic fields has been reported (continued).

Species ^a	Common Name	US? ^b	Sensitivity ^c	Sensory Range	Evidence Basis	Citation
Class Actinopterygii, Subclass Neopterygii, Infraclass Teleostei: teleost fishes						
Order Anguilliformes, Family Anguillidae: freshwater eels						
<i>Anguilla anguilla</i>	European eel	Not in US	E/M	0.4 mV/cm to 19 mV/cm; geomagnetic field	physiological/ behavioral/ anatomical	Vriens and Bretschneider 1979, Tesch 1974, Karlsson 1985, Enger et al. 1976, Berge 1979, Moore and Riley 2009
<i>Anguilla rostrata</i>	American eel	US	E/M	geomagnetic field; 0.067 mV/cm	physiological/ behavioral/ anatomical	Rommel and McCleave 1972, Tesch 1974, Zimmerman and McCleave 1975, Rommel and McCleave 1973, McCleave and Power 1978
<i>Anguilla japonica</i>	Japanese eel	Not in US	M	geomagnetic field; 12,663 to 192,473 nT	physiological	Nishi and Kawamura 2005, Nishi et al. 2005, Nishi et al. 2004
Order Siluriformes, Family Clariidae: labyrinth catfishes						
<i>Clarias batrachus</i>	walking catfish	Not in US	M	n/a	physiological	Garg et al. 1995
Order Siluriformes, Family Ariidae: sea catfishes						
<i>Ariidae</i>	sea catfishes	US	E	n/a	physiological/ anatomical	Collin and Whitehead 2004

Table 4.2-3. Marine fish species (non-elasmobranch) for which information on sensitivity to electric or magnetic fields has been reported (continued).

Species ^a	Common Name	US? ^b	Sensitivity ^c	Sensory Range	Evidence Basis	Citation
Order Salmoniformes, Family Salmonidae: trouts and salmons						
<i>Oncorhynchus keta</i>	chum salmon	US	M	geomagnetic field	behavioral/ anatomical	Yano and Aoyagi 2008, Quinn and Groot 1983, Yano et al. 1997
<i>Oncorhynchus mykiss</i>	steelhead trout	US	M	50 μ T changes to field	physiological/ behavioral/ anatomical	Haugh and Walker 1998, Tanski et al. 2005, Walker et al. 1997, Sadowski et al. 2007, Diebel et al. 2000, Formicki and Winnicki 1998
<i>Oncorhynchus nerka</i>	sockeye salmon	US	M	geomagnetic field	behavioral/ anatomical	Walker et al. 1988, Quinn and Brannon 1982, Quinn et al. 1981, Quinn 1980, Mann et al. 1988
<i>Oncorhynchus tshawytscha</i>	Chinook salmon	US	M	geomagnetic field	behavioral	Taylor 1986
<i>Salmo salar</i>	Atlantic salmon	US	M/E?	0.5-4.0 mT; 0.6 mV/cm	physiological/ behavioral/ anatomical	Tanski et al. 2005, Sadowski et al. 2007, Rommel and McCleave 1973, Moore et al. 1990
<i>Salmo trutta</i>	brown trout	US	M	0.15 – 4.2 mT	physiological/ behavioral	Tanski et al. 2005, Formicki and Winnicki 1998, Formicki et al. 2004, Sadowski et al. 2007
Order Gadiformes, Family Gadidae: cods						
<i>Gadus morhua</i>	Atlantic cod	US	E	2 μ A/cm ²	behavioral	Regnart 1931
Order Scorpaeniformes, Family Scorpaenidae: scorpionfishes						
<i>Sebastes inermis</i>	darkbanded rockfish	Not in US	M	n/a	physiological	Nishi and Kawamura 2006

Table 4.2-3. Marine fish species (non-elasmobranch) for which information on sensitivity to electric or magnetic fields has been reported (continued).

Species ^a	Common Name	US? ^b	Sensitivity ^c	Sensory Range	Evidence Basis	Citation
Order Perciformes, Family Haemulidae: grunts						
<i>Haemulon plumier</i>	white grunt	US	M?	geomagnetic field	behavioral	Quinn and Ogden 1984
Order Perciformes, Family Scombridae: mackerels						
<i>Thunnus albacores</i>	yellowfin tuna	US	M	10 to 50 μ T changes to field	behavioral/ anatomical	Walker 1984, Walker et al. 1984
Order Pleuronectiformes, Family Pleuronectidae: righteye flounders						
<i>Platichthys flesus</i>	European Flounder	Not in US	none	n/a	none: toxicity study - no lethal effects from exposure to 3.7 mT DC fields for 7 weeks	Bochert and Zettler 2004
<i>Pleuronectes platessa</i>	European plaice	Not in US	M?	geomagnetic field	behavioral	Metcalf et al. 1993

^a Species listed alphabetically within Family.

^b US=species occurs in US waters, Not in US=species does not occur in US waters

^c M=magnetosensitivity, E=electrosensitivity, none=species studied with no sensitivity reported

social or reproductive roles. Chung-Davidson et al. (2008) report that differing responses to DC electric fields among male and female sea lamprey at various lifestages may suggest a role for electroreception in reproduction. It is also noted that marine fishes with an electric sense can detect induction voltages generated by their movement through the Earth's magnetic field (Peters et al. 2007). Thus, use of geomagnetic cues for orientation or navigation is another plausible function for the electric sense in fishes.

Magnetoreception

Experimental evidence demonstrates magnetoreception in at least two teleost families (Salmonidae and Scombridae) from orders that lack an electrosense (Table 4.2-3). Some evidence has also been reported for species within three other families that are not known to detect electric fields (Scorpaenidae, Haemulidae, and Pleuronectidae). Marine fishes that are sensitive to magnetic stimuli but lack an electrosense, must detect magnetic stimuli directly. There is limited but significant work to support the existence of a magnetite receptor system (see section 4.2.1.2) in bony fish. Early studies reported the presence of magnetite in the forehead region of tuna and salmon (Walker et al. 1984, Kirschvink et al. 1985, Mann et al. 1988). More recently magnetite crystals and several supporting structures were identified in the olfactory rosette of the rainbow trout, *Oncorhynchus mykiss* (Walker et al. 1997, Diebel et al. 2000). Iron particles consistent with the size and properties of single domain magnetite were visualized in the olfactory rosette using confocal and transmission electron microscopy techniques. A branch of the trigeminal cranial nerve, which normally innervates muscles of the jaw and also carries somatosensory information to the brain, showed a small branch that projected into the chemosensory epithelium of the olfactory system (which is primarily innervated by the olfactory nerve). Neurophysiology experiments on the discharge properties of neurons in this branch of the trigeminal nerve showed excitation responses to applied pulsed magnetic fields across the head when intensity was increased from 25 to 75 μT . However, the magnetoresponsive neurons did not respond when the field was reversed and of equal intensity (polarity insensitive). Although these neurons could not be directly linked to a magnetite receptor cell, subsequent work using nerve fill techniques demonstrated that these nerves project to regions of the olfactory rosette where magnetite crystals occur, but demonstration of direct connection with magnetite receptor cells is still elusive. Nonetheless, the model of magnetite-based magnetoreception is considered the most probable mechanism for the magnetic sense in fish (Kirschvink et al. 2001, Walker 2008). Moore and Riley (2009) report additional recent evidence for magnetite-based magnetoreception in teleost fishes. Concentrations of magnetic material were isolated from the region of the lateral line system in the European eel (*Anguilla anguilla*).

The functional role for the magnetic sense in fishes is hypothesized to be for orientation, navigation, and homing using geomagnetic cues (Dittman and Quinn 1996, Lohmann et al. 2008a, Walker et al. 2007). Use of the magnetic sense for these functions would explain the ability of fishes like salmon and tuna to accomplish long-distance migrations through the open ocean and for diadromous species to reach their natal tributaries with remarkable precision. Despite support among researchers on theoretical grounds, this hypothesis has yet to be bolstered by strong evidence (Walker et al. 2007).

Preliminary Listing of Other Fish Species

Based on evidence for sensitivity to either electric or magnetic fields, fish species from 12 families in 10 orders were targeted for review in this report. This includes 183 species of fish that occur in coastal waters (bottom depth <200 meters) of the continental US. Either direct evidence for these species or evidence for a closely related taxon suggested that these species should be prioritized for consideration of potential sensitivity to EMFs. Appendix Table C-5 provides summarized sensitivity findings in a phylogenetically ordered listing of these species (Nelson et al. 2004). This listing also includes fish from elsewhere throughout the world oceans for which information on sensitivity to electric or magnetic fields has been reported. Thus, findings on sensitivity to electric or magnetic fields can be compared among related species within this table. However, in the case of magnetic sensitivity, it must be emphasized that such taxonomic lists are highly subjective because they are derived from studies on species that respond to magnetic stimuli. If it is demonstrated that a general magnetic sensory system exists in fishes, then these assessments would represent only a small portion of fish fauna that may encounter submarine power cable systems.

Table 4.2-4 presents federally listed threatened or endangered fish species (NMFS 2010a). These species were included in the preliminary listing of fishes regardless of reported sensitivities to ensure careful consideration throughout the process of analyzing potential effects of EMFs.

4.2.3.2 Effects of EMFs from Undersea Power Cables

Comparison of expected EMF levels to reported sensitivities

Reported sensitivities vary among species and studies (Table 4.2-3), and expected EMF levels vary considerably among cable systems (section 4.1). Nonetheless, comparison of expected EMF levels to reported sensitivities reveals that numerous fish species are likely capable of detecting magnetic and induced electric fields from undersea cables.

Much of the work on magnetoreception in fish has involved manipulation of the Earth's magnetic field (generally ~50 μT), and precise sensitivity levels to magnetic fields are not well known (Table 4.2-3). Responses to fields in the range of 10 to 12 μT are reported (Nishi and Kawamura 2005; Walker 1984). However, based on sensitivities reported for other groups of animals and on theoretical levels for fish, likely sensitivities are much lower (Kirschvink and Gould 1981, Lohmann and Lohmann 1996b). For example, Walker et al. (1984) theorized that yellowfin tuna may detect magnetic field intensities as low as 1 to 100 nT. Minimum sensitivity levels for electroreceptive fish (non-elasmobranch) are generally reported at around 0.1 $\mu\text{V}/\text{cm}$ (Table 4.2-3). Lower values have been reported for many elasmobranch species which have similar ampullary receptor systems to most other fish that can detect electric fields. In a recent review by Peters et al. (2007) the lower detection limit for marine fish was estimated to be 0.02 $\mu\text{V}/\text{cm}$.

AC cables are commonly used in Europe and have been proposed in the US for transmission of electricity from offshore wind facilities to shore (and within turbine arrays). AC magnetic fields from cables in the US would have a frequency of 60-Hz. Since the rate of change of the field would be too rapid (60 times per second) for magnetite to respond mechanically to the imposed

Table 4.2-4

Federally listed threatened (T) or endangered (E) fish species (non-elasmobranch) in US waters (NMFS 2010a).

Species	Common name	Federal status	Comments
Order Acipenseriformes, Family Acipenseridae: sturgeons			
<i>Acipenser brevirostrum</i>	shortnose sturgeon	E	
<i>Acipenser medirostris</i>	green sturgeon	T	one listed distinct population segment
<i>Acipenser oxyrinchus desotoi</i>	Gulf sturgeon	T	
Order Salmoniformes, Family Osmeridae: smelts			
<i>Thaleichthys pacificus</i>	eulachon	T	
Order Salmoniformes, Family Salmonidae: trouts and salmon			
<i>Oncorhynchus keta</i>	chum salmon	T	two listed evolutionarily significant units
<i>Oncorhynchus kisutch</i>	coho salmon	E/T ^a	three listed evolutionarily significant units (one E; two T; and one proposed T)
<i>Oncorhynchus mykiss</i>	steelhead trout	E/T	ten listed distinct population segments (one E; nine T)
<i>Oncorhynchus nerka</i>	sockeye salmon	E/T	two listed evolutionarily significant units
<i>Oncorhynchus tshawytscha</i>	Chinook salmon	E/T	nine listed evolutionarily significant units (two E; seven T)
<i>Salmo salar</i>	Atlantic salmon	E	one listed distinct population segment

^a species listed as E/T include populations with differing status

force, magnetite-based receptor systems may not respond to weak AC magnetic fields. Adair (1994) calculated that 60-Hz magnetic fields greater than 5 μ T would be required to exceed forces on magnetite particles from thermal motion alone. Based on this calculation, AC magnetic fields would need to be greater than 5 μ T to be detected by a magnetite detection system. Modeling results provided in Tables B-9 to B-12 suggest that a fish would need to be within several meters of a cable to detect a 60-Hz magnetic field from a cable carrying 1,000 A. Directional information from a time-varying field would also fluctuate. It's not clear to what extent this noise, if detected by a magnetoreceptive fish, might interfere with the DC signal from the geomagnetic field. AC cables would also generate induced electric fields that may be detected by electroreceptive fish. Studies are lacking on the responses of many fish species to time-varying fields, although existing evidence suggests that ampullary receptor systems are generally tuned to low frequency fields in the range of <0.1 to 25 Hz (Collin and Whitehead 2004). It is therefore unclear how many species may respond to 50-60 Hz power frequencies. Putting aside this uncertainty regarding the frequency, based on modeled intensities in Table 4.1-5, the induced AC electric field may be detectable by electroreceptive fish more than 10 meters from the cable.

DC cable systems may be proposed for future offshore renewable energy projects sited at greater distances offshore. The evidence suggests that a magnetite-based mechanism could detect variations in the ambient geomagnetic field produced by the DC magnetic field of the cable. Fish species that have demonstrated the capability to detect the Earth's geomagnetic field would likely detect changes to the field in the vicinity of a DC cable. As illustrated by comparing Figures 4.1-11 and 4.1-12, the total DC field (geomagnetic + cable) that would be sensed by an

organism would depend upon the magnitude of the magnetic field from the cable in combination with the ambient geomagnetic field. The resulting field is highly dependent upon the cable's orientation relative to the Earth's magnetic field. Thus, the total DC field of a cable is specific to project configurations and site conditions. For a cable such as the SwePol link (see Figure 4.1-9), a field may be detectable by fish for over 20 meters on either side of the centerline of the cables. Variations in the local field and orientation of the cable could increase or decrease this distance. Induced electric fields from ocean currents moving through the DC magnetic field would also be within the sensory range of fish that can detect electric fields. Values reported in Table 4.1-4 indicate field intensities that could be detected more than 10 meters away from the cable, in the water column or along the seabed.

Potential Impacts to Other Fishes

Potential impacts to fish from EMFs for a particular undersea cable depend upon the sensory capabilities of a species, the life functions that its magnetic or electric sensory systems support, and the natural history characteristics of the species. Life functions supported by the electric and magnetic sense indicate that species capable of detecting magnetic fields face potential impacts different from those that detect electric fields.

Impacts to magnetosensitive species from an altered magnetic field in the vicinity of a cable would depend upon how a species uses its magnetic sense. While it has been well established that some species can detect magnetic fields, the importance of the magnetic sense for orientation or navigation, is not well understood (Walker et al. 2007). Nonetheless, it has been hypothesized that some fish species use their magnetic sense as a navigation tool to guide their migratory movements (Walker et al. 2007). Much of the research on magnetoreception in fish is on migratory species in the families Salmonidae, Anguillidae and Scombridae (Table 4.2-3). Some have speculated that fish that use the geomagnetic field to guide their movements through an area with an undersea cable may change their direction and speed of travel as they encounter the magnetic field from the cable (Gill and Kimber 2005). It is not known whether the magnetic field is a more important cue for "local" or long-distance navigation. From this perspective, the spatial extent of the magnetic field from an undersea cable would amount to a highly localized influence relative to the distances covered by fish migrating over long distances. However, in some cases, segments of long power cable runs can transect migration routes, feeding grounds, or spawning sites for those species sensitive to EM fields and alter their normal behavior. Such effects are currently unknown.

Some fish species may use a magnetic sense for orientation or homing within a relatively small local range. Limited data are available to support this. Quinn and Ogden (1984) reported the apparent use of a compass system for daily migrations in the white grunt (*Haemulon plumieri*), and speculated on the role of a magnetic sense in this behavior. Metcalfe et al. (1993) reported orientation behavior in the European plaice (*Pleuronectes platessa*) that suggested the possible use of a magnetic sense, and physiological evidence for a magnetic sense has recently been reported for the darkbanded rockfish (*Sebastes inermis*; Nishi and Kawamura, 2006). Nevertheless, if a species uses a magnetic sense for homing capabilities, these capabilities may be affected in close proximity to certain cable systems.

Electrosensitive species may be affected by induced electric fields from AC or DC cables. Electrosensitive species that also sense magnetic fields (through an independent magnetic sense or through their electrosensory system) could be affected as discussed above for magnetosensitive fishes. Induced electric fields may also potentially affect functions such as prey detection or social interaction and reproduction (Table 4.2-5). Potential effects to electroreceptive fish species are also discussed for elasmobranchs (section 4.2.2.2).

Although limited, some direct evidence of fish responses to undersea cables exists. Westerberg (2000) and Öhman et al. (2007) reported a slower swimming speed in migrating European eel (*Anguilla anguilla*) crossing over a DC cable. Some individual eels veered while passing over an electrified cable and swam slower which suggests that they detected the cable's magnetic field. Nonetheless, eels were not impeded from crossing the cable, and the author concluded that there was no indication that the cable constituted a permanent obstacle to the migration of adult eels or elvers. Several reports suggest potential behavioral response of sturgeon when exposed to AC electric fields from electrodes in the water (Basov 2007) and to AC magnetic fields from overhead power lines (Gertseva and Gertsev 2002, Poddubny 1967 as cited in Gill et al. 2005). Most other studies have focused on elasmobranchs (and are discussed in Section 4.2.2), but may be relevant to other species as well.

4.2.3.3 Priority Species by Region

Based on existing evidence of sensitivity in comparison to expected levels of EMFs from undersea cables, those species most likely to sense EMFs were identified as “priority species” for the final level of assessment based on natural history attributes. Of the 183 fish species on the preliminary listing, 49 species that occur in US coastal waters were identified as priority. Natural history characteristics for these species are provided in Table 4.2-5, and their distribution within BOEMRE planning areas is shown in Table 4.2-6. Additional life history information including geographic distribution is in Appendix Tables C-12 and C-13.

The natural history characteristics of a species indicate to what extent that species may inhabit an area in which it would encounter EMFs from cables. Several important attributes allow for the identification of species that are likely to be at higher risk of effects from EMFs than others. First, demersal species, including those that are strictly benthic and also those considered benthopelagic, live in close association with the seafloor where the highest EMF levels from undersea cables would be encountered. Some demersal species may face a unique risk of effects from EMFs related to their feeding behaviors. It has been suggested that electroreceptive species that use their electric sense to detect prey buried within the bottom substrate may be attracted by EMFs from cables and pursue the fields as if they were prey items (Gill et al. 2005) although this hypothesis has not been fully developed. The likelihood of this response occurring is probably related to the degree to which frequencies of electric fields emitted by prey items overlap with the static field of DC cables or the 60 Hz field of AC power cables. A second attribute of importance is a species' distribution relative to the coastline and to depths in which offshore renewable energy facilities are most likely to be constructed. Near-shore and coastal species with bottom depth distributions to less than 100 meters are more likely to encounter cables than are those species in deeper waters, especially those occurring off the continental shelf in depths greater than 200 meters. A third important attribute is the geographic distribution of a species,

Table 4.2-5

Characteristics of priority fish species (non-elasmobranch) in US waters and behavior potentially affected by electric or magnetic fields.

Species	Common Name	Status ^a	EFH ^b	Habitat ^c	Depth (m) ^c	Behavior Potentially Affected ^c
Superclass Agnatha, Class Cephalaspidomorphi, Order Petromyzontiformes, Family Petromyzontidae: lampreys						
<i>Lampetra ayresii</i>	river lamprey			demersal	n/a	detection of prey, predators, or conspecifics; orientation or navigation
<i>Lampetra camtschatica</i>	Arctic lamprey			demersal	0 to 50	detection of prey, predators, or conspecifics; orientation or navigation
<i>Lampetra tridentata</i>	Pacific lamprey			demersal	0 to 1100	detection of prey, predators, or conspecifics; orientation or navigation
<i>Petromyzon marinus</i>	sea lamprey			demersal	1 to 2200	detection of prey, predators, or conspecifics; orientation or navigation
Class Chondrichthyes, Subclass Holocephali, Order Chimaeriformes, Family Chimaeridae: shortnose chimaeras						
<i>Hydrolagus collieri</i>	spotted ratfish		P	demersal	shallow to 400	detection of prey, predators, or conspecifics; orientation or navigation
Class Actinopterygii: ray-finned fishes						
Class Actinopterygii, Subclass Chondrostei, Order Acipenseriformes, Family Acipenseridae: sturgeons						
<i>Acipenser brevirostrum</i>	shortnose sturgeon	E		benthic	primarily estuarine, occasional nearshore coastal	detection of prey, predators, or conspecifics; orientation or navigation
<i>Acipenser medirostris</i>	green sturgeon	T		benthic	shallow to 122	detection of prey, predators, or conspecifics; orientation or navigation
<i>Acipenser oxyrinchus</i>	Atlantic sturgeon			benthic	shallow to 50	detection of prey, predators, or conspecifics; orientation or navigation
<i>Acipenser oxyrinchus desotoi</i>	Gulf sturgeon	T		benthic	shallow to 55	detection of prey, predators, or conspecifics; orientation or navigation
<i>Acipenser transmontanus</i>	white sturgeon			benthic	shallow to 122	detection of prey, predators, or conspecifics; orientation or navigation

Table 4.2-5. Characteristics of priority fish species (non-elasmobranch) in US waters and behavior potentially affected by electric or magnetic fields (continued).

Species	Common Name	Status ^a	EFH ^b	Habitat ^c	Depth (m) ^c	Behavior Potentially Affected ^c
Class Actinopterygii, Subclass Neopterygii, Infraclass Teleostei: teleost fishes						
Order Anguilliformes, Family Anguillidae: freshwater eels						
<i>Anguilla rostrata</i>	American eel			Demersal	0 to 464	orientation or navigation
Order Siluriformes, Family Ariidae: sea catfishes						
<i>Bagre marinus</i>	gafftopsail catfish			Demersal	0 to 50	detection of prey, predators, or conspecifics; orientation or navigation
<i>Bagre panamensis</i>	Chihuila			Demersal	shallow	detection of prey, predators, or conspecifics; orientation or navigation
Order Salmoniformes, Family Osmeridae: smelts						
<i>Thaleichthys pacificus</i>	Eulachon	T		Pelagic	shallow to 300	orientation or navigation
Order Salmoniformes, Family Salmonidae: trouts and salmon						
<i>Coregonus clupeaformis</i>	lake whitefish			Demersal	18 to 128	orientation or navigation
<i>Oncorhynchus clarkii</i>	cutthroat trout			Demersal	0 to 200	orientation or navigation
<i>Oncorhynchus gorbuscha</i>	pink salmon		P	Demersal	shallow to 250	orientation or navigation
<i>Oncorhynchus keta</i>	chum salmon	T		benthopelagic	shallow to 250	orientation or navigation
<i>Oncorhynchus kisutch</i>	coho salmon	E/T	NP, P	Demersal	shallow to 250	orientation or navigation
<i>Oncorhynchus mykiss</i>	steelhead trout	E/T		benthopelagic	shallow to 200	orientation or navigation
<i>Oncorhynchus nerka</i>	sockeye salmon	E/T		Pelagic	shallow to 250	orientation or navigation
<i>Oncorhynchus tshawytscha</i>	Chinook salmon	E/T	NP, P	benthopelagic	shallow to 375	orientation or navigation
<i>Salmo salar</i>	Atlantic salmon	E	NE/MA	benthopelagic	shallow to 210	orientation or navigation
<i>Salvelinus alpinus</i>	Arctic char			benthopelagic	30 to 70	orientation or navigation
<i>Salvelinus confluentus</i>	bull trout			benthopelagic	n/a	orientation or navigation
<i>Salvelinus fontinalis</i>	brook trout			Demersal	15 to 27	orientation or navigation
<i>Salvelinus malma</i>	Dolly Varden			benthopelagic	0 to 200	orientation or navigation

Table 4.2-5. Characteristics of priority fish species (non-elasmobranch) in US waters and behavior potentially affected by electric or magnetic fields (continued).

Species	Common Name	Status ^a	EFH ^b	Habitat ^c	Depth (m) ^c	Behavior Potentially Affected ^c
Order Perciformes, Family Scombridae: mackerels						
<i>Acanthocybium solandri</i>	Wahoo		SA	Pelagic	0 to 12	orientation or navigation
<i>Auxis rochei</i>	bullet mackerel			Pelagic	10+	orientation or navigation
<i>Auxis thazard</i>	frigate mackerel			Pelagic	50+	orientation or navigation
<i>Euthynnus affinis</i>	Kawakawa			Pelagic	0 to 200	orientation or navigation
<i>Euthynnus alletteratus</i>	little tunny		G, SA	Pelagic	1 to 150	orientation or navigation
<i>Euthynnus lineatus</i>	black skipjack			Pelagic	0 to 40	orientation or navigation
<i>Katsuwonus pelamis</i>	skipjack tuna		P, S	Pelagic	0 to 260	orientation or navigation
<i>Sarda chiliensis</i>	Pacific bonito			Pelagic	n/a	orientation or navigation
<i>Sarda sarda</i>	Atlantic bonito			Pelagic	80 to 200	orientation or navigation
<i>Scomber colias</i>	Atlantic chub mackerel			Pelagic	n/a	orientation or navigation
<i>Scomber japonicus</i>	Pacific chub mackerel		P	Pelagic	0 to 300	orientation or navigation
<i>Scomber scombrus</i>	Atlantic mackerel			Pelagic	0 to 183	orientation or navigation
<i>Scomberomorus cavalla</i>	king mackerel		G, SA	Pelagic	5 to 140 (usually 5 to 15)	orientation or navigation
<i>Scomberomorus maculatus</i>	Spanish mackerel		G, SA	Pelagic	10 to 35	orientation or navigation
<i>Scomberomorus regalis</i>	Cero		G, SA	Pelagic	1 to 20	orientation or navigation
<i>Scomberomorus sierra</i>	Pacific sierra			Pelagic	0 to 12	orientation or navigation
<i>Thunnus alalunga</i>	Albacore		P, S	Pelagic	0 to 600	orientation or navigation
<i>Thunnus albacares</i>	yellowfin tuna		P, S	Pelagic	1 to 250 (usually 1 to 100)	orientation or navigation
<i>Thunnus atlanticus</i>	blackfin tuna			Pelagic	50 and greater	orientation or navigation
<i>Thunnus obesus</i>	bigeye tuna		P, S	Pelagic	0 to 250	orientation or navigation
<i>Thunnus orientalis</i>	Pacific bluefin tuna		P	Pelagic	1 to 200	orientation or navigation
<i>Thunnus thynnus</i>	bluefin tuna		S	Pelagic	0 to 985	orientation or navigation

^a T = threatened; E = endangered

^b Essential Fish Habitat has been designated by the listed Fishery Management Council: NP=North Pacific, P=Pacific, NE/MA=New England/Mid-Atlantic, SA=South Atlantic, G=Gulf of Mexico, and S=Secretarial (NMFS 2010b)

^c Citations for data sources provided in Appendix Table C-6

Table 4.2-6

Geographic distribution of priority fish species (non-elasmobranch) within BOEMRE planning areas and regions of Alaska.

Species	Common name	Geographic region ^a													
		North Atlantic	Mid Atlantic	South Atlantic	Straits of Florida	Eastern Gulf of Mexico	Central Gulf of Mexico	Western Gulf of Mexico	Southern California	Central California	Northern California	Washington/Oregon	Alaska (Aleutian Islands)	Alaska (Frontier)	Alaska (Northslope)
Superclass Agnatha, Class Cephalaspidomorpha, Order Petromyzontiformes, Family Petromyzontidae: lampreys															
<i>Lampetra ayresii</i>	river lamprey									X	X	X	X		
<i>Lampetra camtschatica</i>	Arctic lamprey												X	X	X
<i>Lampetra tridentata</i>	Pacific lamprey									X	X	X	X	X	
<i>Petromyzon marinus</i>	sea lamprey	X	X	X	X	X	X	X							
Class Chondrichthyes, Subclass Holocephali, Order Chimaeriformes, Family Chimaeridae: shortnose chimaeras															
<i>Hydrolagus colliei</i>	spotted ratfish									X	X	X	X	X	
Class Actinopterygii: ray-finned fishes															
Class Actinopterygii, Subclass Chondrostei, Order Acipenseriformes, Family Acipenseridae: sturgeons															
<i>Acipenser brevirostrum</i>	shortnose sturgeon	X	X	X											
<i>Acipenser medirostris</i>	green sturgeon									X	X	X	X	X	X
<i>Acipenser oxyrinchus</i>	Atlantic sturgeon	X	X	X											
<i>Acipenser oxyrinchus desotoi</i>	Gulf sturgeon					X	X								
<i>Acipenser transmontanus</i>	white sturgeon									X	X	X	X	X	
Class Actinopterygii, Subclass Neopterygii, Infraclass Teleostei: teleost fishes															
Order Anguilliformes, Family Anguillidae: freshwater eels															
<i>Anguilla rostrata</i>	American eel	X	X	X	X	X	X	X							
Order Siluriformes, Family Ariidae: sea catfishes															
<i>Bagre marinus</i>	gafftopsail catfish	X	X	X	X	X	X	X							
<i>Bagre panamensis</i>	chihuil									X					
Order Salmoniformes, Family Osmeridae: smelts															
<i>Thaleichthys pacificus</i>	eulachon									X	X	X	X	X	

Table 4.2-6. Geographic distribution of priority fish species (non-elsmobranch) within BOEMRE planning areas and regions of Alaska (continued).

Species	Common name	Geographic region ^a														
		North Atlantic	Mid Atlantic	South Atlantic	Straits of Florida	Eastern Gulf of Mexico	Central Gulf of Mexico	Western Gulf of Mexico	Southern California	Central California	Northern California	Washington/Oregon	Alaska (Aleutian Islands)	Alaska (Frontier)	Alaska (Northslope)	
Order Salmoniformes, Family Salmonidae: trouts and salmon																
<i>Coregonus clupeaformis</i>	lake whitefish													X	X	X
<i>Oncorhynchus clarkii</i>	cutthroat trout										X	X				
<i>Oncorhynchus gorbuscha</i>	pink salmon									X	X	X	X	X	X	X
<i>Oncorhynchus keta</i>	chum salmon									X	X	X	X	X	X	X
<i>Oncorhynchus kisutch</i>	coho salmon									X	X	X	X	X	X	
<i>Oncorhynchus mykiss</i>	steelhead trout									X	X	X	X	X	X	
<i>Oncorhynchus nerka</i>	sockeye salmon									X	X	X	X	X		
<i>Oncorhynchus tshawytscha</i>	Chinook salmon									X	X	X	X	X	X	
<i>Salmo salar</i>	Atlantic salmon	X	X													
<i>Salvelinus alpinus</i>	Arctic char															X
<i>Salvelinus confluentus</i>	bull trout										X	X	X	X	X	
<i>Salvelinus fontinalis</i>	brook trout	X	X													
<i>Salvelinus malma</i>	Dolly Varden											X	X	X	X	
Order Perciformes, Family Scombridae: mackerels																
<i>Acanthocybium solandri</i>	wahoo	X	X	X	X	X	X	X								
<i>Auxis rochei</i>	bullet mackerel	X	X	X	X	X	X	X	X	X	X	X				
<i>Auxis thazard</i>	frigate mackerel	X	X	X	X	X	X	X	X	X	X	X				
<i>Euthynnus affinis</i>	kawakawa								X							
<i>Euthynnus alletteratus</i>	little tunny	X	X	X	X	X	X	X								
<i>Euthynnus lineatus</i>	black skipjack								X							
<i>Katsuwonus pelamis</i>	skipjack tuna	X	X	X	X	X	X	X	X							

Table 4.2-6. Geographic distribution of priority fish species (non-elsmobranch) within BOEMRE planning areas and regions of Alaska (continued).

Species	Common name	Geographic region ^a													
		North Atlantic	Mid Atlantic	South Atlantic	Straits of Florida	Eastern Gulf of Mexico	Central Gulf of Mexico	Western Gulf of Mexico	Southern California	Central California	Northern California	Washington/Oregon	Alaska (Aleutian Islands)	Alaska (Frontier)	Alaska (Northslope)
<i>Sarda chiliensis</i>	Pacific bonito								X	X	X	X	X		
<i>Sarda sarda</i>	Atlantic bonito	X	X	X	X	X	X	X							
<i>Scomber colias</i>	Atlantic chub mackerel	X	X	X	X	X	X	X	X						
<i>Scomber japonicus</i>	Pacific chub mackerel								X	X	X	X	X	X	
<i>Scomber scombrus</i>	Atlantic mackerel	X	X	X											
<i>Scomberomorus cavalla</i>	king mackerel	X	X	X	X	X	X	X							
<i>Scomberomorus maculatus</i>	Spanish mackerel		X	X	X	X	X	X							
<i>Scomberomorus regalis</i>	cero	X	X	X	X	X	X	X							
<i>Scomberomorus sierra</i>	Pacific sierra								X						
<i>Thunnus alalunga</i>	albacore	X	X	X	X	X	X	X	X	X	X	X			
<i>Thunnus albacares</i>	yellowfin tuna	X	X	X	X	X	X	X	X	X	X				
<i>Thunnus atlanticus</i>	blackfin tuna	X	X	X	X	X	X	X							
<i>Thunnus obesus</i>	bigeye tuna	X	X	X	X	X	X	X	X	X	X	X			
<i>Thunnus orientalis</i>	Pacific bluefin tuna								X	X	X	X	X		
<i>Thunnus thynnus</i>	bluefin tuna	X	X	X	X	X	X	X							

^a see Figure 1.0-1; Citations for range data provided in Appendix Table C-7

which indicates whether that species is known to occur in the area of a particular proposed project (Table 4.2-6).

Species with the highest conservation status or fisheries management status must be given top priority in the process of assessing potential impacts. Federal status under ESA (Table 4.2-4) is indicated in Table 4.2-5. Also, those species for which Essential Fish Habitat (EFH) has been designated are identified in this table. Additional natural history attributes such as species movement (whether they are migratory or non migratory) or changes in distribution patterns related to life stage or season are provided for federally listed species and managed species in Appendix Table C-12. Factors that help to determine the risk for potential impact to fish from EMFs vary greatly at each level of consideration including (1) physical factors (e.g., cable system attributes that determine EFH levels), (2) biological factors (e.g., sensitivity levels for various species), and (3) ecological factors (e.g., natural history attributes for various species). Thus, project and site specific analyses of potential EMF impacts to local fish species are essential. A case study that addresses considerations for assessing potential EMF effects is provided below for a representative fish species (sockeye salmon).

4.2.3.4 Case Study of the Sockeye Salmon *Oncorhynchus nerka*

The ability to detect magnetic fields has been reported for several species of salmonids (Table 4.2-3). Salmonid populations that rely on long-distance migrations between feeding grounds and their natal spawning tributaries are among the fish species with the highest conservation and fisheries status in US waters. Therefore, sockeye salmon (*Oncorhynchus nerka*) was selected for a case study on how physical data for EMF levels could be compared to the biological data on sensitivity and natural history to assess potential effects to fish. *O. nerka* is one of six federally listed species in the family Salmonidae that are found in US coastal waters (Table 4.2-6; Figure 4.2-3). The following paragraphs review data on sensitivity and natural history for *O. nerka* and consider this information relative to expected EMF levels from undersea cables.

Quinn (1980) reported that lake migrating sockeye salmon fry maintained the same compass heading after removal from a river and placement into covered orientation chambers. A 90 degree change in the horizontal component of the Earth's magnetic field changed the direction of the fry at night. This response was not seen in the daytime when other visual cues were available. Quinn et al. (1981) subsequently tested for magnetic material in sockeye salmon but results were equivocal. These authors also reported that reversal of the vertical component of the geomagnetic field did not cause a 180 degree change in the orientation of sockeye salmon fry; these results were interpreted as showing that the fry primarily orient to the horizontal component of the geomagnetic field. Experiments with sockeye salmon smolts confirmed that this life stage also orients using magnetic cues (Quinn and Brannon 1982). However, Quinn and Brannon (1982) also reported that when smolts in an uncovered orientation chamber had an unobstructed view of the sky, the smolts did not change their orientation in response to a 90 degree rotation of the horizontal component of the geomagnetic field. Ueda et al. (1986) used a SQUID magnetometer to search for magnetic material in the body of sockeye salmon and a number of other salmonid species. As with the earlier study (Quinn et al. 1981), no magnetic material other than contaminants was found. Within two years of the publication of these findings, however, two studies published together in *The Journal of Experimental Biology*

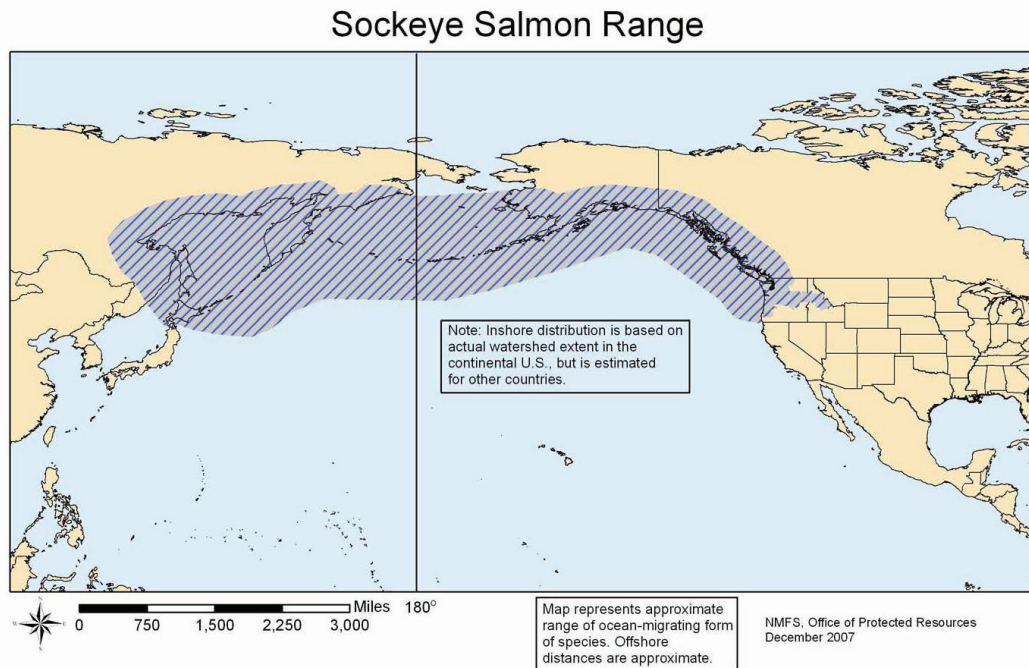

Figure 4.2.3. Sockeye salmon range (NMFS 2010a)

provided detailed descriptions of biogenic magnetite in *O. nerka* (Mann et al. 1988, Walker et al. 1988). Mann et al. (1988) used high-resolution transmission electron microscopy to study the ultrastructure, morphology, and organization of magnetite crystals isolated from the ethmoid tissue (in the skull) of adult salmon. Based on these observations they described magnetite crystals aligned in individual chain structures in which both the particles and length of the chains appeared to be consistent with use for magnetoreception. Walker et al. (1988) reported on the production of biogenic magnetite in various life stages of the sockeye salmon. Magnetite quantities were found to increase throughout the juvenile stages, with significant quantities found in the skull of adult sockeye salmon. The authors concluded that salmon smolts possessed sufficient quantities of magnetite to detect even small changes in the intensity of the Earth's magnetic field.

The studies described above for sockeye salmon along with other investigations into a magnetic sense in salmonids have been reviewed and considered by a number of authors (e.g., Able 1991, Walker et al. 2007, Lohmann et al. 2008a). Evidence supports the capability of salmonids to detect and orient to magnetic fields. Evidence also supports the use of visual and olfactory cues for orientation by salmonids (Able 1991). In a recent paper by Lohmann et al. (2008a), the authors present the hypothesis that some populations of salmon that undergo long distances migrations imprint on the magnetic signature of their birth place, but that non-magnetic local cues are more important in pinpointing spawning areas.

The natural history traits of sockeye salmon suggest that some life stages may be exposed to EMFs from power transmission cables for offshore renewable energy projects. *O. nerka* is an anadromous species that spawns in fresh water but lives the majority of its adult life at sea (there is also a landlocked form of this species called “kokanee”; Froese and Pauly 2010). Juvenile

sockeye typically leave their freshwater nurseries in lakes or streams and enter the sea in their first or second year (Froese and Pauly 2010). By the time juvenile sockeye enter the sea they are pelagic. Younger salmon remain near shore then move further offshore as adults, where they typically spend two years before returning to spawn (NMFS 2010a). *O. nerka* ranges from central California northward throughout much of Alaska to the Bering Sea. Wave energy projects are being considered within this region (DOE 2009, Boehlert et al. 2008), and therefore the potential for encountering powered cables from renewable energy projects may soon exist. As a pelagic species, sockeye are less likely to encounter EMFs from undersea cables than are bottom dwelling species. However, life stages (e.g., juveniles) inhabiting near shore habitats may have a greater potential exposure to EMFs from cables. Adults may also encounter cables on their return migration from sea. Exposed cables within the water column from wave, ocean current, or floating wind turbines may also be a potential source of exposure to EMFs for salmon.

AC cables with 60-Hz magnetic fields are most likely be used for near shore renewable energy projects in the US. As discussed in previous sections, it is uncertain whether salmon could detect the time-varying magnetic field from an AC cable. The rate of change of the field may be too rapid for a magnetite-based mechanism to respond to weak fields. Detection of the field would require intensities estimated at $> 5 \mu\text{T}$ (Adair 1994; see previous discussion). Based on this estimate, modeling results presented in Tables B-9 to B-12 suggest that a salmon would need to be within several meters of a cable to detect a 60-Hz magnetic field from a cable carrying 1,000 A.

DC cables may be used in the future as projects sited farther from shore would require longer transmission cables and higher power capacities. Evidence suggests that a magnetite-based mechanism like that hypothesized for salmon could detect variations in the ambient geomagnetic field produced by the DC magnetic field of the cable. Since salmon have demonstrated the capability to detect the Earth's geomagnetic field, they would likely detect changes to the field in the vicinity of a DC cable. As illustrated by comparing Figures 4.1-11 and 4.1-12, the total DC field (geomagnetic + cable) that would be sensed by an organism would depend upon the magnitude of the magnetic field from the cable (in these figures it is varied by the distance between the cables) as well as the cable's orientation. Thus, the total DC field of a cable is highly specific to project configurations and site conditions. For a cable such as the SwePol link (see Figure 4.1-9), a field may be detectable by salmon for over 20 meters on either side of the centerline of the cables. The distance would be smaller for other cable configurations in which the conductors are closer together. Variations in the local field and orientation of the cable could increase or decrease this distance.

Conclusion

The conservation status of *O. nerka* requires that potential effects of EMFs from undersea cables must be carefully considered. Evidence is lacking to make a determination in this matter without speculation. No studies were found that have tested effects of power cable EMFs (AC or DC) on salmon. Basic information about the magnetic sense and its functional role in salmon is also lacking. Nonetheless, available evidence allows for some reasonable conclusions. Effects from DC cables would be more likely than from AC cables; this follows from the knowledge that salmon have demonstrated the capability to detect DC magnetic fields but theoretically may not

detect AC magnetic fields (at least at very low intensities). Even in the case of DC fields, the pelagic nature of salmon would distance them from the highest intensity fields, and only at certain life stages would salmon inhabit areas where cables are likely to be built. Furthermore, evidence indicates that salmon likely use multiple environmental cues to guide their movements. Thus a disturbance to magnetic cues in the direct vicinity of a cable may be compensated for by information from sources such as visual or olfactory cues. Taken together, there is currently little specific evidence suggesting that salmon would be adversely affected by EMFs from undersea power cables but additional specific evidence would be needed to have greater confidence in this assessment. Nevertheless, any potential effects would depend upon site specific and project specific factors related to both the magnitude of EMFs and the ecology of local salmon populations such as proximity and orientation of cables relative to natal spawning rivers.

4.2.4. Marine Mammals

4.2.4.1 Review of Existing information

Three phylogenetic orders of marine mammals can be found inhabiting the U.S. continental shelf: Carnivora (polar bears, sea otters, sea lions, fur seals, walrus, and earless seals), Sirenia (manatees), and Cetacea (whales and dolphins). No evidence of magnetic sensitivity has been reported for members of Carnivora or Sirenia. Among marine mammals, magnetic sensitivity has been primarily investigated in cetaceans, and will be discussed herein. No evidence for electrosensitivity in marine mammals has been reported.

Many cetacean species migrate seasonally up to thousands of kilometers each year between summer feeding grounds in northern waters, and wintering grounds in southern waters. Much remains to be learned about the hypothesis that aquatic animals use a magnetic sense to navigate over these long distances (Walker et al. 2003). To date, the evidence for cetaceans' magnetic sensitivity is observational, theoretical (based on correlation studies), behavioral, physiological, and anatomical (i.e. the presence of magnetite).

Due to their large size, and other logistical constraints, controlled experiments are not feasible for many cetacean species. However, statistically reliable studies correlating marine mammal behavior with geomagnetic fields have been recorded. Within the Order Cetacea, members from both suborders mysticetes (i.e. fin and humpbacks), and odontocetes (i.e. sperm whales, beaked whales, and multiple species of dolphins, and porpoises), have shown positive correlations with geomagnetic field differences, thus making it more plausible that all members of the Order Cetacea are magneto-sensitive. Because of the nature of such studies, the potential confounding role of other factors could not be tested. Although none of the studies have determined the mechanism for magneto-sensitivity, the suggestion from these studies is that members of the Order Cetacea can sense the Earth's magnetic field and may use it to migrate long distances. The most current listing of cetaceans for which information on magneto-sensitivity has been reported is provided in Table 4.2.-7.

Cetaceans appear to use the Earth's magnetic field for migration in two ways: as a map by moving parallel to the contours of the local field topography, and as a timer based on the regular

Table 4.2-7

Listing of marine mammals for which information on sensitivity to electric or magnetic fields has been reported.

Species ^a	Common Name	US? ^b	Sensitivity ^c	Sensory range	Evidence basis	Citations
	Cetacea	US	M			Kirschvink, et al. 1986
<i>Balaenoptera physalus</i>	fin whale	US	M	0.05 μ T; earth's magnetic field	Theoretical	Kirschvink 1990; Walker, et al. 1992
<i>Megaptera novaeangliae</i>	humpback whale	US	M	earth's magnetic field	anatomical- magnetite in dura matter	Bauer 1985
<i>Physeter macrocephalus</i>	sperm whale	US	M	earth's magnetic field;0.05 μ T	Theoretical	Kirschvink, et al. 1986; Kirschvink 1990
<i>Kogia breviceps</i>	pygmy sperm whale	US	M	earth's magnetic field;0.05 μ T	Theoretical	Kirschvink, et al. 1986; Kirschvink 1990
<i>Kogia simis</i>	dwarf sperm whale	US	none			Kirschvink 1990
<i>Ziphiidae</i>	beaked whales	US	none			Kirschvink 1990
<i>Ziphius cavirostris</i>	Cuvier's beaked whale	US	M; none			Bauer 1985; Kirschvink 1990
<i>Tursiops truncatus</i>	bottlenose dolphin	US	M; M; none	earth's magnetic field;0.05 μ T	behavioral/physiological; anatomical -magnetite in dura matter; theoretical	Kuznetsov 1999; Bauer 1985; Kirschvink 1990
<i>Delphinus delphis</i>	common dolphin	US	M;M;none	earth's magnetic field;0.05 μ T	anatomical-magnetite in dura matter; theoretical; theoretical	Zoeger, et al.1981; Kirschvink 1986; Kirschvink 1990; Hui 1994
<i>Globicephala melaena</i>	long-fin pilot whale	US	M	earth's magnetic field;0.05 μ T	Theoretical	Kirschvink, et al. 1986; Kirschvink 1990
<i>Globicephala macrorhynchus</i>	short-fin pilot whale	US	M	0.05 μ T	Theoretical	Kirschvink, et al. 1986; Kirschvink 1990
<i>Lagenorhynchus acutus</i>	Atlantic white-sided dolphin	US	M	0.05 μ T	Theoretical	Kirschvink 1990
<i>Stenella coeruleoalba</i>	striped dolphin	US	M	earth's magnetic field;0.05 μ T	Theoretical	Kirschvink, et al. 1986; Kirschvink 1990
<i>Stenella plagiodon/frontalis</i>	Atlantic spotted dolphin	US	M	0.05 μ T	Theoretical	Kirschvink 1990
<i>Grampus griseus</i>	Risso's dolphin	US	none		Theoretical	Kirschvink 1990
<i>Phocoena phocoena</i>	harbor porpoise	US	M	0.05 μ T	Theoretical	Kirschvink 1990
<i>Phocoenoides dalli</i>	Dall's porpoise	US	M		anatomical - magnetite in dura matter	Bauer 1985

^aalphabetic within family

^bUS = present in US waters

^cM = magnetosensitivity; none = study revealed no evidence of electro- or magnetosensitivity

fluctuations in the field allowing animals to monitor their progress on this map (Klinowska 1990). Cetaceans do not appear to use the Earth's magnetic field for directional information (Klinowska 1990).

Evidence of Magnetic Sensitivity

Relationship to Geomagnetic Field

Klinowska (1985) indirectly demonstrated a possible functional magnetic sense in cetaceans by determining that otherwise healthy whales can strand themselves alive; he stated that "live strandings of cetaceans are *exclusively* mistakes made by animals attempting to use geomagnetic topography for orientation." Analyzing the circumstances surrounding these strandings may identify the sensory mechanism responsible for the error (Walker, et al. 1992). Klinowska (1985) plotted live stranding locations from Great Britain on magnetic field maps. Geomagnetic topography maps illustrate local distortions of the earth's magnetic fields resulting from geologic features. Areas with rock containing materials with magnetic properties increase the total local field, and are known as high anomalies. Areas with other geological properties distort the field by decreasing the total field, resulting in low anomalies or magnetic minima (Klinowska 1985). Klinowska (1985) suggests that marine mammal migration routes tend to be parallel to geomagnetic valleys (magnetic minima), and that stranding points occur where contours are perpendicular to the coast. Additionally, these strandings occur in offshore species that are not as familiar with coastal waters (Klinowska 1985).

The results indicated an association with stranding locations and magnetic minima which intersected with the coast, suggesting that cetaceans possess a magnetic sensory system. Kirschvink et al. (1986) mapped stranding locations from computerized data sets onto digital aeromagnetic data (geomagnetic data collected via aircraft) for the east coast of the U.S., and developed methods to demonstrate statistically reliable associations of stranding sites with locations where magnetic minima intersect with the coast. Results from this study indicated a strong correlation between stranding locations and magnetic minima from Cape Cod, Massachusetts to Cape Canaveral, Florida in five species: Atlantic white-sided dolphin, fin whale, long-fin pilot whale, bottlenose dolphin, and Atlantic spotted dolphin (Kirschvink et al. 1986).

Kirschvink (1990) compared 421 live cetacean strandings to the spatial and temporal variations in the geomagnetic fields from Texas to Maine. Live-strandings were found to be associated with geomagnetic minima in long-fin and short-fin pilot whales, striped dolphin, Atlantic spotted dolphin, Atlantic white-sided dolphin, fin whale, common dolphin, harbor porpoise, sperm whale, and pygmy sperm whale. These species were statistically more likely to live-strand within 2 km of locations with slightly weaker geomagnetic fields (geomagnetic minima; Table 4.2-8). Stranding locations of other species (including bottlenose dolphin, Risso's dolphin (*G. griseus*), dwarf sperm whale, and members of the beaked whale family Ziphiidae) were not statistically correlated to geomagnetic anomalies. Kirschvink (1990) does not offer an explanation for the discrepancy in the correlation of bottlenose dolphin live-stranding locations relative to geomagnetic minima between the two studies. The author emphasized that correlation-based studies like this can only provide information about the *places* where live strandings events take place, and that nothing can be

Table 4.2-8

Species for which live stranding locations from Texas to Maine were significantly correlated to geomagnetic minima. Kirschvink 1990

Common Name	Species	P value
Fin whale	<i>Balaenoptera physalus</i>	<0.001
Sperm whale	<i>Physeter macrocephala</i>	<0.05
Pygmy sperm whale	<i>Kogia breviceps</i>	<0.001
Long-fin pilot whale	<i>Globicephala melaena</i>	<0.01
Short-fin pilot whale	<i>G. macrorhynchus</i>	<0.01
Striped dolphin	<i>Stenella coeruleoalba</i>	<0.05
Atlantic spotted dolphin	<i>S. frontalis</i>	<0.05
Atlantic white-sided dolphin	<i>Lagenorhynchus acutus</i>	<0.001
Common dolphin	<i>Delphinus delphis</i>	<0.01
Harbor porpoise	<i>Phocoena phocoena</i>	<0.01

inferred from these data concerning the *cause* of stranding events, but concluded that a geomagnetic sensory system does exist in cetaceans and is important for long-distance migration. Kirschvink (1990) also suggested that total intensity variations of as little as 0.050 μ T (0.1 percent of the earth's total field) were strong enough to influence stranding locations.

Kirschvink et al. (1986) found that correlation of stranding locations for bottlenose dolphin from Cape Hatteras to Cape Cod to geomagnetic minima was statistically significant, but this relationship was not apparent when a larger geographic area (Texas to Maine) was considered (Kirschvink 1990). The author did not offer an explanation for this apparently conflicting result.

Additional regional variation was reported for the common dolphin's stranding locations correlated to magnetic minima from Maine to Texas (Kirschvink 1990). In a different study, Hui (1984) plotted aggregations of common dolphin sighting locations from aerial surveys on bottom topography and magnetic field contour maps of the Southern California Bight. Results indicated that in southern California, the common dolphin's swim direction and orientation were not associated with geomagnetic patterns, but were associated with bottom topography. These latter results indicate that dolphins do not rely solely on geomagnetic fields, but also use additional cues (i.e. bottom topography) to navigate.

Fin whales occur with relative abundance in the Northeast Atlantic, and are known to make seasonal migrations in a general north/south direction. Little information is available regarding what signals are detected or followed during these migrations however. Walker (1992) performed Monte Carlo simulations on fin whale sightings from Cape Cod MA to Cape Hatteras NC to test whether whale positions were random with respect to geomagnetic field gradients and bathymetry during migrations. Walker (1992) found that sighting positions were statistically associated with areas of high geomagnetic field gradients during summer ($p = 0.02$), and with low field intensity ($p = 0.02$) and low gradient ($p = 0.008$) in the fall. No associations with bathymetric parameters were found in any season. The author concluded that fin whales and perhaps other mysticete species recognize and associate with geomagnetic field features

independently of other geophysical stimuli, and that this association with geomagnetic field features is correlated with seasonal migration patterns. Walker (1992) suggested that a magnetic-based system is the only one yet proposed for cetaceans that could provide the sensitivity level necessary to detect fluctuations in the geomagnetic field as low as $0.1 \mu\text{T}$.

Anatomical Evidence

Currently, magnetite has been reported in the dura matter (outer membrane surrounding the brain, closest to the skull) of the following cetaceans: Common Pacific dolphin (Zoeger, et al. 1981), Dall's porpoise, bottlenose dolphin, Cuvier's beaked whale, and the humpback whale (Bauer et al. 1985) and in the tongues and lower jawbones of harbor porpoises (Klinowska 1990).

Zoeger, et al. (1981) performed necropsies on five Common Pacific dolphins, and cut each head into five coronal sections. All sections of the heads were detectibly magnetized, with one section, the supra orbital region, more magnetic than the others (Zoeger, et al. 1981). Strongly magnetized tissue from one dolphin contained an opaque disc-like particle that was visible to the naked eye, and with what appeared to be nerve fibers on the surface of this particle (Zoeger, et al. 1981). The author concluded that certain dolphins may have magnetic material in their dura matter. Zoeger, et al. (1981) felt that it may be used as a magnetic field receptor based on the association of apparent nerve fibers with magnetite.

Behavioral and Physiological Reactions

Kuznetsov (1999) exposed dolphins (Delphinidae) to permanent magnetic fields while observing behavioral (i.e. movement, sharp exhalations, and acoustic activity) and physiological (i.e. electrocardiogram) reactions. The results showed reactions to magnetic field intensities of 32, 108, and $168 \mu\text{T}$ during 79, 63, and 53% of the trials respectively, indicating that dolphins are sensitive to permanent magnetic fields.

Preliminary Listing of Marine Mammal Species

The Order Cetacea includes a wide variety of whales and dolphins, with various lifestyles and natural histories. However, one behavior common to most, if not all cetaceans is the undertaking of seasonal or annual migrations. Some of these migrations encompass thousands of kilometers (i.e. humpback whales in the Pacific migrating from their feeding grounds in Alaska to wintering grounds in Hawaii). For some rarely-sighted species (i.e. beaked whales and pygmy sperm whales) little is known about their life history, including migratory patterns. However, because at least one member from each of the families (Balaenidae, Balaenopteridae, Eschrichtiidae, Physeteridae, Monodontidae, Delphinidae, and Phocoenidae) within the Order Cetacea (with the exception of beaked whale family Ziphiidae) is known to migrate, members from the entire Order known to occur within the U.S. continental shelf waters will be considered for this study.

Eight species of mysticetes (baleen whales) and 14 species of odontocetes (toothed whales) including sperm whales, rarely-sighted beaked whales, dolphins, and porpoises occur within the nearshore coastal waters of the U.S. Of these species, twelve are endangered or depleted (Table 4.2-9).

Table 4.2-9

Federally listed endangered (E), threatened (T), delisted, and depleted marine mammals in US waters.

Species	Common Name	Federal Status	Comments/Critical Areas
Order Cetacea			
Mysticeti			
<i>Balaena mysticetus</i>	bowhead whale	E	
<i>Balaenoptera borealis</i>	sei whale	E	
<i>B. musculus</i>	blue whale	E	
<i>B. physalus</i>	fin whale	E	
<i>Eschrichtius robustus</i>	gray whale	Delisted	
<i>Eubalaena glacialis</i>	North Atlantic right whale	E	Bay of Fundy, Scotian Shelf, Cape Cod Bay, Massachusetts Bay, Great South Channel, southeastern U.S. coast (FL-GA)
<i>E. japonicus</i>	North Pacific right whale	E	Bering Sea, Gulf of Alaska
<i>Megaptera novaeangliae</i>	humpback whale	E	
Odontoceti			
<i>Delphinapterus leucas</i>	Beluga whale	E	Cook Inlet, AK (NMFS proposed critical habitat December 2009)
<i>Orcinus orca</i>	Killer whale	Southern residents = E; Transients = Depleted	WA : 1) Summer Core Area in Haro Strait and waters around San Juan Islands, 2) Puget Sound, and 3) Strain of San Juan de Fuca
<i>Physeter macrocephalus</i>	Sperm whale	E	
<i>Stenella plagiodon/frontalis</i>	Atlantic spotted dolphin		Pacific northeast offshore (depleted)
<i>Tursiops truncatus</i>	Bottlenose dolphin		Western North Atlantic (depleted)
Order Sirenia			
<i>Trichechus manatus latirostris</i>	Florida manatee	E	multiple sites in northeast to southwest FL
Order Carnivora			
<i>Ursus maritimus</i>	Polar bear	T	
<i>Enhydra lutris kenyoni</i>	Northern sea otter	T	southwest and Aleutian Islands, AK
<i>Enhydra lutris nereis</i>	Southern sea otter	T	
Superfamily Pinnipedia			
<i>Eumetopias jubatus</i>	Stellar sea lion	Eastern AK stock = T; Western AK stock = E	20 nm buffer around all major haul outs; southwest and Aleutian Islands, AK; and 3000 ft seaward from Long Brown, Seal Rocks, and Pyramid Rock, OR; Sugarloaf Isl., Cape Mendocino, southeast Farralon Isl. And Ano Nuevo Isl., CA
<i>Arctocephalus townsendi</i>	Guadalupe fur seal	T	

4.2.4.2 Effects of EMF from Undersea Cables

Comparison of expected EMF levels to reported sensitivities

Direct calculation of magnetic fields from cables alone does not provide adequate information for a general assessment of impact or risk. As described in Section 4.2.1.2, the ambient magnetic field is the result of both the dominant geomagnetic dipole and the residual field that arises from local magnetic features of the crust that can vary greatly over relatively short distances. Thus interactions between the cable system relative to the earth's magnetic field are site-specific and dependent upon factors such as the intensity, shape, direction, and spatial extent of the resultant magnetic field (cable + geomagnetic; Figure 4.1-11 and 4.1-12). Additionally, the distance between cables and the depth of cable burial affect the resulting magnetic intensity. DC cables can be strapped together to minimize the magnetic field, however, cables may also be buried in separate trenches (i.e. 0.5 to 10m apart) to minimize total power failure in the event of a cable breach. Changing the orientation of the cables with respect to the Earth's magnetic field to minimize the magnetic field is not an option for most projects, and therefore the maximum intensity levels will be assumed for this discussion.

Kirschvink (1990) postulated that whales have a detection threshold for magnetic intensity gradients (i.e. changes in magnetic field levels with distance) of 0.1 percent of the earth's magnetic field or about 0.05 μT . The expected magnetic fields from existing and proposed undersea power cables were well above the Earth's magnetic field (up to 265 μT for a bipolar HVDC system; Section 4.1). Modeled results indicate that the "average" AC cables buried to a depth of 1 m would emit field intensities greater than 0.05 μT as far as 20 m above the cable, and 20 m along the sea floor (Appendix Table B-2), and as high as at least 45 m above the cable and up to about 50 m along the sea floor for a DC system (Appendix Table B-4). It should be noted that the small, time varying AC magnetic field predicted from modeling may be perceived differently, or not even detected, by sensitive marine organisms compared to the persistent, static geomagnetic field generated by Earth. Correlation studies discussed in Section 4.2.4.1 suggest that it is likely that members of the Order Cetacea are able to detect DC magnetic fields emitted from undersea cables within the vicinity of 50 m above and out to 68 m horizontally from an "average" cable, although it is not known how cetaceans would respond to these fields.

Potential Effects On Marine Mammals

The existing body of current literature suggests that cetaceans can sense the geomagnetic field and use it to navigate during migrations (Klinowska 1985; Kirschvink 1990; Walker 1992; Hui 1994). It is not clear whether they use the geomagnetic field solely or in addition to other regional cues. It is also not known which components of the geomagnetic field cetaceans are sensing (i.e. the horizontal or vertical component, field intensity or inclination angle). Nor is it known what effects the perturbations in the geomagnetic field within the vicinity of buried power cables may have on these animals.

Marine mammals are thus likely to be very sensitive to minor changes in magnetic fields (Walker et al. 2003). There is a potential for animals to react to local variations of the geomagnetic field caused by power cable EMFs. Depending on the magnitude and persistence of the confounding magnetic field, such an effect could cause a trivial temporary change in swim direction, or a longer detour during the animal's migration (Gill et al. 2005).

Table 4.2-10

Characteristics of priority marine mammal species in US waters and behavior potentially affected by magnetic field.

Species	Common Name	Status	Habitat ^a	Depth (m) ^a	Behavior Potentially Affected
Order Cetacea					
Mysticeti					
<i>Balaena mysticetus</i>	bowhead whale	E	pelagic	cont. shelf and slope	migration
<i>Balaenoptera borealis</i>	sei whale	E	pelagic	nearshore to cont. shelf edge	migration
<i>B. musculus</i>	blue whale	E	pelagic	Pacific = near shore to EEZ; Atlantic = within EEZ	migration
<i>B. physalus</i>	fin whale	E	pelagic	Pacific = near shore to EEZ; Atlantic = nearshore to 1000	migration
<i>Eschrichtius robustus</i>	gray whale	Delisted	benthic	nearshore to 155	migration
<i>Eubalaena glacialis</i>	North Atlantic right whale	E	pelagic	coastal waters to >200	migration
<i>E. japonicus</i>	North Pacific right whale	E	pelagic	cont. shelf <100	migration
<i>Megaptera novaeangliae</i>	humpback whale	E	pelagic	Pacific = nearshore; Atlantic = nearshore to 1000	migration
Odontoceti					
<i>Delphinapterus leucas</i>	beluga whale	E	benthic	shallow nearshore to 20	migration
<i>Delphinus capensis</i>	long-beaked common dolphin		pelagic	nearshore, within 50 nm of coast	migration
<i>Delphinus delphis</i>	common dolphin		pelagic	Pacific = nearshore to EEZ; Atlantic = cont. shelf waters 200-2000	migration
<i>Globicephala macrorhynchus</i>	short-fin pilot whale		pelagic	Pacific = within EEZ; Gulf of Mex. = 100-1000; Atlantic = 100-4000	migration
<i>G. melaena</i>	long-fin pilot whale		pelagic	100-4000	migration
<i>Kogia breviceps</i>	pygmy sperm whale		pelagic/benthic	Pacific = cont. slope; Gulf of Mex. = 100-1000+; Atlantic = 100-4000	migration
<i>K. simus</i>	dwarf sperm whale		pelagic/benthic	Pacific = cont. slope; Gulf of Mex. = 100-1000+; Atlantic = 100-4000	migration
<i>Lagenorhynchus acutus</i>	Atlantic white-sided dolphin		pelagic/benthopelagic		migration
<i>Lagenorhynchus obliquidens</i>	Pacific white-sided dolphin		pelagic/benthopelagic	WA to CA = cont. shelf and slope; AK = inshore to shelf and slope	
<i>Orcinus orca</i>	killer whale	E, Depleted	pelagic	Pacific = inshore to outer coastal waters; Gulf of Mex. = 1000+; Atlantic = within EEZ	migration
<i>Phocoena phocoena</i>	harbor porpoise		pelagic/benthic		movement between areas?
<i>Phocoenoides dalli</i>	Dall's porpoise		pelagic/benthopelagic	nearshore cont. shelf and slope waters to offshore	migration
<i>Physeter macrocephalus</i>	sperm whale		pelagic/benthic	Pacific = cont. shelf and slope; Atlantic = 100 - 4000 and inshore of 100 south of New England; Gulf of Mex. = 1000+	migration

Table 4.2-10. Characteristics of priority marine mammal species in US waters and behavior potentially affected by magnetic field (continued).

Species	Common Name	Status	Habitat ^a	Depth (m) ^a	Behavior Potentially Affected
<i>Stenella plagidon/frontalis</i>	Atlantic spotted dolphin	Depleted (Pacific)	pelagic/benthic	Gulf of Mex. = 10-200 to cont. slope <500; Atlantic = inshore and cont. shelf and slope	migration
<i>Tursiops truncatus</i>	bottlenose dolphin	Depleted	pelagic/benthic	inshore bays and estuaries to cont. shelf	migration
Order Sirenia					
<i>Trichechus manatus latirostris</i>	Florida manatee	E	freshwater-oceanic benthic	<50	

^aCitations for habitat and depth provided in Appendix Table C-9

Although information is lacking regarding specific effects from EMF undersea electrical cables, potential risks of effects are related to the animals' proximity to the cables. Therefore, the species that are feeding near or in the benthos (i.e. benthopelagic feeding dolphins or benthic feeding beluga and gray whales) may have a greater potential for exposure than those species that forage elsewhere throughout the water column (Table 4.2-11).

In regards to potential exposure to EMF from undersea power cables, the water depth is an important factor for those species that are feeding throughout the water column. For example, beluga, Atlantic spotted dolphins, and killer whales are all known to inhabit relatively shallow waters (20-30 m) and would certainly be exposed to resultant magnetic alterations that may extend to 50 m above the cable. Also potentially affected however, are those species inhabiting relatively deeper waters (100-150 m), but which may dive to within 20 m of the bottom. For example, North Atlantic right whales inhabit coastal waters to at least 200 m, and because they have been observed to be feeding near bottom (180 m), this behavior may expose them to magnetic field levels above their sensitivity threshold. There is no scientific evidence as to what the response to exposures to such a field would be however.

4.2.4.3 Priority Species by Region

Based on comparison of expected levels of EMFs from undersea cables with the evidence for sensitivity to magnetic fields, priority marine mammal species were selected. These species were deemed most likely to be capable of sensing EMFs. Natural history attributes of these priority species were assessed relative to potential effects of EMFs. Priority marine mammal species can be divided into two groups: one group contains species for which there is direct evidence of magnetic sensitivity (Table 4.2-12). The other group contains closely-related species from US waters for which there is no current evidence for sensitivity although the same sensitivity may be inferred. Although all ESA-listed species are of concern, listed marine mammals in orders (Carnivora and Sirenia) for which there is no evidence of magnetic sensitivity have not been prioritized.

Scientific studies examining effects of EMF on marine mammals have not been conducted. However, it is possible that many marine mammals are capable of detecting the magnetic fields resulting from undersea power cables, particularly those species that can detect the Earth's

Table 4.2-11

Characteristics of marine mammals in US waters and behavior potentially affected by magnetic field.

Species	Common name	Status	Habitat ^a	Depth (m) ^a	Behavior Potentially Affected
Order Cetacea					
Mysticeti					
<i>Balaena mysticetus</i>	bowhead whale	E	Pelagic	155	migration
<i>Balaenoptera borealis</i>	sei whale	E	Pelagic		migration
<i>B. musculus</i>	blue whale	E	Pelagic	105	migration
<i>B. physalus</i>	fin whale	E	Pelagic	>200	migration
<i>Eschrichtius robustus</i>	gray whale	Delisted	Benthic	155	migration
<i>Eubalaena glacialis</i>	North Atlantic right whale	E	Pelagic	>200	migration
<i>E. japonicus</i>	North Pacific right whale	E	Pelagic	<100	migration
<i>Megaptera novaeangliae</i>	humpback whale	E	Pelagic	150-210	migration
Odontoceti					
<i>Delphinapterus leucas</i>	beluga whale	E	Benthic	20	migration
<i>Delphinus capensis</i>	long-beaked common dolphin		Pelagic	200	migration
<i>Delphinus delphis</i>	common dolphin		Pelagic	200	migration
<i>Globicephala macrorhynchus</i>	short-fin pilot whale		Pelagic	1000	migration
<i>G. melaena</i>	long-fin pilot whale		Pelagic	1000	migration
<i>Kogia breviceps</i>	pygmy sperm whale		pelagic/demersal	300	migration
<i>K. simus</i>	dwarf sperm whale		pelagic/demersal	300	migration
<i>Lagenorhynchus acutus</i>	Atlantic white-sided dolphin		pelagic/ benthopelagic	100-300	migration
<i>Orcinus orca</i>	killer whale	E/Depleted	Pelagic	30	migration
<i>Phocoena phocoena</i>	harbor porpoise		pelagic/benthic	20-60	movement between areas?
<i>Phocoenoides dalli</i>	Dall's porpoise		pelagic/ benthopelagic	500	migration
<i>Physeter macrocephalus</i>	sperm whale		pelagic/demersal	mean 392, max 985	migration
<i>S. frontalis/plagidon</i>	Atlantic spotted dolphin	Depleted (Pacific)	pelagic/benthic	20-180	migration
<i>Tursiops truncatus</i>	bottlenose dolphin	Depleted	pelagic/benthic	300	migration
Order Sirenia					
<i>Trichechus manatus latirostris</i>	Florida manatee	E	freshwater-oceanic benthic	<50	

^aCitations for habitat and depth provided in Appendix Table C-6

magnetic field and use it (in addition to other cues) for migration. Responses to exposure to cable-induced magnetic fields are likely to vary depending on the geographic region for the energy project, available habitat for each species, the resulting intensity of the EMF cables orientation and direction combined with local geomagnetic intensity. In addition, depending on the depth of burial, those marine mammals feeding on benthic organisms may excavate or uncover buried power cables. Potential responses from exposure to EMF may include a temporary change in swim direction, a more serious delay to the animal's migration, possibly stranding if EMF from undersea cables resulted in magnetic minima.

4.2.4.4 Case Study of the Bottlenose Dolphin *Tursiops truncatus*



Figure 4.2-4. Bottlenose dolphin.

The bottlenose dolphin (*Tursiops truncatus*; Figure 4.2-4) was selected as an example of how one would assess the potential interaction of a marine mammal species with magnetic fields from submarine cables from an offshore wind project with the information available for several reasons. There is direct and indirect evidence that this species is sensitive to magnetic fields. Kuzhetsov (1999) found that bottlenose dolphins exhibited both behavioral (sharp exhalations, acoustic activity, and movement) and autonomic (heart rate) responses to DC magnetic fields from magnets at intensities of 32, 108, and 168 μT . Zoegler et al. (1981) found magnetite associated with nerve fibers, suggesting a sensory function, in the dura matter of a common dolphin (a member of the same family, Delphinidae, as bottlenose dolphins). Live strandings of bottlenose dolphins was found to be correlated with geomagnetic minima in the Atlantic from Cape Cod, Massachusetts to Cape Canaveral, Florida (Kirschvink et al. 1986), although this relationship was not apparent when data from Texas to Maine were included (Kirschvink 1990). No explanation for the difference in the results was offered. Many of the stranding positions suggested that total intensity variations of $<0.05 \mu\text{T}$ were enough to influence stranding locations (Kirschvink et al. 1986), and that this species could, therefore, sense these low magnetic intensities.



Figure 4.2-5. Worldwide distribution of bottlenose dolphin.

Bottlenose dolphins are globally distributed (Figure 4.2-5), with 19 separate but geographically overlapping stocks, occurring in all continental U.S. waters between 45°N and 45°S . Coastal populations of bottlenose dolphins can be found inshore to the 25m isobath in the Atlantic, the 20m isobaths in the Gulf of Mexico, and the 50m isobaths in the Pacific (Waring et al. 2009; Caretta et al. 2009) and they feed on benthic invertebrates and fish, behaviors which could

expose them to magnetic fields from undersea power cables. Additionally, this species is known to undergo seasonal movements or migrations in some regions, for example the seasonal migration from the western North Atlantic in the spring and summer to a more southerly

Table 4.2-12

Geographic distribution of marine mammals within BOEMRE planning areas and regions of Alaska

Species	Common Name	Geographic Region ^a														
		North Atlantic	Mid Atlantic	South Atlantic	Straits of Florida	Eastern Gulf of Mexico	Central Gulf of Mexico	Western Gulf of Mexico	Southern California	Central California	Northern California	Washington/Oregon	Alaska (Aleutian Islands)	Alaska (Frontier)	Alaska (Northslope)	
Order Cetacea																
Mysticeti																
<i>Balaena mysticetus</i>	bowhead whale													x	x	x
<i>Balaenoptera borealis</i>	sei whale	x							x	x	x	x				
<i>B. musculus</i>	blue whale	x							x	x	x	x	x			
<i>B. physalus</i>	fin whale	x							x	x	x	x	x	x		
<i>Eubalaena glacialis</i>	North Atlantic right whale	x	x	x	x											
<i>E. japonicus</i>	North Pacific right whale								x	x	x	x	x			
<i>Eschrichtius robustus</i>	gray whale								x	x	x	x	x	x	x	x
<i>Megaptera novaeangliae</i>	humpback whale	x	x	x	x					x	x	x	x	x		
Odontoceti																
<i>Delphinapterus leucas</i>	beluga whale													x	x	x
<i>Delphinus capensis</i>	long-beaked common dolphin								x	x						
<i>Delphinus delphis</i>	common dolphin	x	x						x	x	x	x				
<i>Globicephala macrorhynchus</i>	short-fin pilot whale	x	x	x	x	x	x	x	x	x	x	x	x			
<i>G. melaena</i>	long-fin pilot whale	x	x													
<i>Kogia breviceps</i>	pygmy sperm whale	x	x	x	x	x	x	x	x	x	x					
<i>K. simus</i>	dwarf sperm whale	x	x	x	x	x	x	x	x	x	x					
<i>Lagenorhynchus acutus</i>	Atlantic white-sided dolphin	x														
<i>Lagenorhynchus obliquidens</i>	Pacific white-sided dolphin								x	x	x	x	x			
<i>Orcinus orca</i>	killer whale	x				x	x	x	x	x	x	x	x			
<i>Phocoena phocoena</i>	harbor porpoise	x	x						x	x	x	x	x	x		
<i>Phocoenoides dalli</i>	Dall's porpoise								x	x	x	x	x			
<i>Physeter macrocephalus</i>	sperm whale	x	x						x	x	x	x	x	x		
<i>S. frontalis/plagidon</i>	Atlantic spotted dolphin	x	x	x	x	x	x	x								
<i>Tursiops truncatus</i>	bottlenose dolphin	x	x	x	x	x	x	x	x	x						
Order Sirenia																
<i>Trichechus manatus latirostris</i>	Florida manatee	x	x	x	x	x	x	x								

^a see Figure 1.0-1; Citations for range data provided in Appendix C-7

distribution in the winter. Migrants following inshore routes could also be exposed to magnetic fields emitted by undersea power cables.

Available Magnetic Intensity Information

Modeled results indicate that an “average” AC cable buried to a depth of 1m would emit field intensities up to 0.05 μT 15-20 m above the cable, and about 18-20 m along the sea floor (Appendix Table B-2). It is unlikely that organisms with a magnetite-based detection mechanism would respond to weak AC magnetic fields because the rate of change (reversal of polarity) of the field would be too rapid for the magnetite to respond mechanically to the imposed force. Adair (1994) calculated that 60-Hz magnetic fields greater than 5 μT would be required to exceed forces on magnetite particles from thermal motion alone, thus, one might hypothesize that AC magnetic fields would need to be greater than 5 μT to be detected by a magnetite detection system in a dolphin or other organism. Based on data provided in Appendix Table B-2, a dolphin would have to be much closer than 2 m to detect a 60-Hz magnetic field from a cable carrying 250 A and the duration of exposure would likely be very limited. As the magnetic field is proportional to the current, exposure would increase with increasing current and detection distance would increase.

Most submarine cables that transport electricity collected from a group of wind turbines back to shore are high-voltage AC cables. The current flow on these export cables would be greater than for any cables carrying electricity from a single turbine or within an array of turbines. Even if detectable, however, the dolphin would have to be within a few meters of the export cable.

More distant offshore wind projects favor the use of DC cables for main power transmission for economic considerations. If dolphins are capable of detecting the earth’s geomagnetic field, then there is ample evidence to suggest that a magnetite-based sensory mechanism could detect variations in the ambient geomagnetic field produced by the DC magnetic field of the cable. As illustrated by comparing Figures 4.1-11 and 4.1-12, the total DC field (geomagnetic plus cable) that would be sensed by an organism would depend upon the magnitude of the magnetic field from the cable (in these figures it is varied by the distance between the cables) as well as the cable’s orientation relative to the geomagnetic field.

Spatial extents of predicted DC magnetic field intensities modeled in the absence of the geomagnetic field are summarized in Appendix Table B-4. DC cables buried to 1.0 m and separated by 0.5 m (Appendix Table B-7) emitted magnetic field intensities within bottlenose dolphins’ sensitivity threshold ($<0.05 \mu\text{T}$) for up to 40-45 m above the cable, and for more than 44 m along the sea floor. For cables buried to 1.0 m, and separated by 1 m (Appendix Table B-8), the field remained above 0.05 μT for at least 50 m above the cable (the model and calculations only went to 50 m above the cable), and 62 m along the sea floor. Variations in the local geomagnetic field, orientation of the cable, and separation between the output and return cables could increase or decrease this distance.

Conclusion

Experimental evidence for many cetacean species is very difficult to obtain, and although physiological and anatomical evidence of magnetic sensitivity is not conclusively demonstrated, the correlations between geomagnetic minima and live-stranding of many species, as described in Section 4.2.3.1, are suggestive and provide a sufficient basis to recommend further research. The overlap in bottlenose dolphins’ utilization of the U.S. coastal waters (i.e. habitat range, depth ranges, benthic feeding behavior, and seasonal movements between areas), their presumed

sensitivity threshold of $<0.05 \mu\text{T}$, and the range of magnetic fields emitted (50 m plus above the cable, and 48 to 68 m along the sea floor) indicate that dolphins may have the potential to detect and respond to magnetic fields of DC cables. Natural variations in the earth's DC magnetic field within a range of 2 km have been statistically correlated to reports of live dolphin strandings (Kirschvink et al. 1986 and Kirschvink 1990). Potential responses could include a temporary change in swim direction or a deviation from a migratory route (and subsequent slowing of the migration; Gill et al. 2005), but these theoretical responses have not been tested. Depending on the orientation of a DC cable to the geomagnetic field, a undersea cable could cause a local decrease in the magnetic field, but modeling described in Section 4.1 suggests that the likelihood of such a change affecting a large enough area to elicit a significant course alteration or even stranding would be low.

4.2.5. Sea Turtles

4.2.5.1 Review of Existing information

Evidence Basis for Sensitivity

Sea turtles are known to possess geomagnetic sensitivity (but not electro sensitivity) that is used for orientation, navigation, and migration. Sea turtles are able to use the Earth's magnetic fields in two ways: 1) for directional or compass-type information to maintain a heading in a particular direction and 2) in a more complex way for positional, or map-type information to assess a position relative to a specific geographic destination (Lohmann et al. 1997). Evidence for sea turtles' ability to sense magnetic fields consists of, for the most part, observational and experimental studies (Table 4.2-13). Most experimental studies on orientation and navigation in both the laboratory and field have focused on sea turtle hatchlings (green, loggerhead, and leatherbacks) due to the large size and power of adults (Lohmann et al. 2008b). Experimental methods include displacement of sea turtles and sensory manipulation (for example eye goggles for blocking visual cues and strong magnets carried on turtles heads). Most recently, satellite telemetry studies have provided insights into sea turtles' navigation processes and have allowed scientists to reconstruct migration routes (Papi et al. 2000). Anatomical evidence also exists: magnetite has been isolated in the dura matter of green turtles (Kirschvink 1983).

Sea turtle life can be considered a continuous series of migrations, with each phase of migration having a different goal and therefore potentially using different mechanisms of sensory abilities. For example, juvenile and adult turtles migrate to specific (and different) locations to feed and mate. Hatchlings begin life by orienting themselves to the open ocean using visual light cues that are low on the horizon to find the ocean. Once in the ocean, hatchlings initially rely on wave cues to establish and maintain their offshore headings and then at some point appear to use the Earth's magnetic field (Lohmann et al. 1997). Loggerhead hatchlings were tracked from Florida, and scientists found that they continued on the same seaward heading even after entering offshore waters where wave directions no longer coincided with their established course (Lohmann et al. 1997). These results indicate that loggerhead hatchlings can orient to the Earth's magnetic fields, suggesting the use of magnetic compass orientation (Lohmann et al. 1997).

Table 4.2-13

Listing of sea turtles for which information on sensitivity to electric or magnetic fields has been reported.

Species ^a	Common Name	US? ^b	Sensitivity ^c	Sensory Range	Evidence Basis	Citations
Cheloniidae						
<i>Caretta caretta</i>	loggerhead turtle	US	M	0.00469-4000 μ T	experimental-displacement and laboratory arena	Avens and Lohmann 2003, Avens and Lohmann 2004, Avens et al. 2003, Cain et al. 2005, Goff et al. 1998, Irwin and Lohmann 2003, Irwin and Lohmann 2005, Light et al. 1993, Lohmann 1991, Lohmann and Lohmann 1994a, Lohmann and Lohmann 1994b, Lohmann and Lohmann 1996a, Lohmann et al. 1999, Lohmann et al. 2001
<i>Chelonia mydas</i>	green turtle	US	M	29.3-200 μ T	experimental-displacement and laboratory arena; observational-satellite tags	Alerstam et al. 2003, Avens and Lohmann 2004, Hays et al. 2002, Hays et al. 2003, Irwin et al. 2004, Lohmann et al. 1999, Lohmann et al. 2004, Lohmann et al. 2008b, Luschi et al. 2001, Luschi et al. 2007, Papi et al. 2000
<i>Lepidochelys kempii</i>	Kemp's ridley turtle	US	M	geomagnetic field	theoretical	Putman and Lohmann 2008
Dermochelyidae						
<i>Dermochelys coriacea</i>	leatherback turtle	US	M	geomagnetic field	experimental	Lohmann and Lohmann 1993

^a Species listed alphabetically within Family^b US=species occurs in US waters^c M=magnetosensitivity, E=electrosensitivity, none=species studied with no sensitivity reported

Sea turtle hatchlings begin their lives by swimming out into the open ocean, where they will eventually come in contact with large ocean currents. In the Atlantic Ocean, hatchlings (with the exception of leatherbacks) remain in the Atlantic gyre for many years; little is known about this life stage. After this stage, most sea turtle species navigate toward U.S. coastal waters to feed; when sexually mature, they will make their first migration back to their natal beach to mate or lay eggs. Migration of juveniles to feeding grounds or of mature turtles to breeding or nesting grounds are considered to be complex, with a specific location or goal destination. Such a complex migration requires the map-type or positional information from the Earth's magnetic field (Lohmann et al. 2008b).

Long Range and Short Range Migration

Juvenile and adult sea turtles have the ability to migrate between their feeding grounds and natal nesting beaches, separated by hundreds or thousands of kilometers. Migrations to nesting beaches occur after years spent in distant open-ocean or coastal habitats feeding grounds. Precisely how sea turtles navigate to specific locations is not fully understood. Lohmann et al. (1999) suggested the possibility that turtles use one strategy and set of cues to navigate to the general vicinity of the feeding ground or nesting beach, and another set of cues to actually pinpoint the goal. Most recently, Lohmann et al. (2008b) stated that green and loggerhead sea turtles rely on multiple cues for such long range goal-specific navigation, which may be divided into two steps. The turtles first use their magnetic map sense to guide them to the vicinity of the target area. This is then followed by use of local cues (most likely olfactory, not magnetic) to pinpoint the final destination. To date, only green and loggerhead turtles have been studied regarding goal navigation and it is not known how these findings may relate to other species.

At each location on the globe, magnetic field lines intersect at the Earth's surface at a specific and predictable angle of inclination. Hatchling loggerhead sea turtles can detect both the inclination angle and field intensity, and can also distinguish among magnetic fields from different oceanic regions (Lohmann et al. 2008b).

A displacement study done off the southeast coast of the U.S. illustrates not only that hatchlings are able to detect the inclination angle and field intensity from different oceanic regions but that a change in these parameters can affect their course of direction (Lohmann et al. 2008c). Hatchling loggerheads taken from their natal beach in Florida were exposed in the laboratory to inclination angles and field intensities that correspond to different locations within the Atlantic gyre. Those hatchlings exposed to inclination angle and intensity similar to that of northern Florida swam south (as they normally would to enter the North Atlantic Gyre). Hatchlings exposed to inclination angle and intensity similar to the northeastern edge of the Atlantic gyre swam south (as they would to stay within the gyre), and those exposed to inclination angle and intensity like that of the southernmost part of the gyre, swam west northwest. These results illustrate that specific magnetic field characteristics elicit orientation responses in hatchling sea turtles (Lohmann et al. 2008c).

Displacement experiments indicate that juvenile turtles use magnetic information as a component of a classical navigation map to migrate to specific geographic locations (Lohmann et al. 2004). The fact that individual sea turtles are known to leave the open ocean and settle in very diverse feeding areas indicates that juvenile turtles' abilities to navigate to specific locations are partly

based on their experience as well as a learned understanding of the Earth's magnetic field. Effects of masking the Earth's magnetic field on the homing ability of adult green sea turtles were examined by placing strong magnets on the heads of individuals that were displaced from their breeding island in the Indian Ocean (Luschi et al. 2007). The turtles with magnets took longer to home and followed more convoluted routes than the control turtles. Researchers additionally discovered that the magnets had an adverse effect on turtles' navigation when attached to the turtles during the homing process as well as for the turtles only exposed to magnets (not attached to their heads) during transfer to the release site (i.e. magnets were not on their heads during homing). These results may be interpreted in two ways. One is that turtles can use their magnetic sense to derive general information of direction of displacement during transport. Alternatively, the application of strong magnets might cause persistent effects on the turtles' magnetoreceptors well after removal (Lohmann et al. 2008b). Most of the turtles with magnetic treatment did eventually return to their breeding island, although their routes were less direct than turtles without magnets (Luschi et al. 2007). These results indicate unknown alternative mechanisms that sea turtles can use if needed, to find their nesting areas even with impaired magnetic sense (Lohmann et al. 2008b).

Preliminary Listing of Sea Turtle Species

Within the nearshore, continental shelf waters of the U.S., there are six species of sea turtles, all of which are either threatened or endangered (Table 4.2-14). Loggerhead, green, hawksbill, Kemp's ridley, and olive ridley sea turtles belong to the same family, Cheloniidae, and leatherback sea turtles belong to the family Dermochelyidae. Although these species have somewhat similar lifestyles, their geographic ranges and foraging habits vary. As mentioned before, experimental and behavioral studies have been done primarily on loggerhead and green turtles (with a few satellite tagging studies done with leatherbacks more recently), and therefore sensitivity levels and behavioral responses are not available for the other species. However, since all species are known to undertake long distance migrations, and belong to the same Order (Testudines), it is conservative to consider that all sea turtles within the U.S. waters may be able to sense magnetic fields, and use them for orientation, navigation, and migration.

4.2.5.2 Effects of EMF from Undersea Cables

Comparison of Expected EMF Levels to Reported Sensitivities

Sea turtles can sense magnetic fields and use the earth's magnetic field (as well as other cues) for long range navigation, migration, and orientation. Multiple studies have demonstrated magnetosensitivity and behavioral responses to field intensities ranging from 0.0047 to 4000 μT for loggerhead turtles, and 29.3 to 200 μT for green turtles (Table 4.2-13 and Appendix Table C-11). While other species have not been studied, anatomical, life history, and behavioral similarities suggest that they could be responsive at similar threshold levels.

Probable intensities of EMFs emitted from undersea power cables are described in section 4.1. Comparison of these results with sensitivity levels for sea turtles suggests that turtles are capable of sensing magnetic fields from undersea cables. Modeled and measured magnetic field levels from various existing undersea power cables were well above the Earth's magnetic field (up to 265 μT for a bipolar HVDC system). These results indicate that AC cables buried to a depth of 1 m would emit field intensities less than 0.05 μT to 25 m above the cable, and 24 m along the sea

Table 4.2-14

Federally listed threatened (T) or endangered (E) sea turtles in US waters.

Source: NMFS 2010a

Species	Common name	Federal status	Comments
<i>Caretta caretta</i>	loggerhead turtle	T	
<i>Chelonia mydas</i>	green turtle	E/T ^a	Florida and Mexico's Pacific coast breeding colonies Endangered; others Threatened
<i>Eretmochelys imbricata</i>	hawksbill turtle	E	
<i>Lepidochelys kempii</i>	Kemp's ridley turtle	E	
<i>Lepidochelys olivacea</i>	olive ridley turtle	E/T	Mexico's Pacific coast breeding colonies Endangered; others Threatened
<i>Dermochelys coriacea</i>	leatherback turtle	E	

^a species with E/T status include populations of endangered and threatened status

floor. A DC system is modeled to emit field intensities less than 0.05 μ T as high as at least 50 m above the cable and 68 m along the sea floor (Table 4.2-6). Small, time varying AC magnetic fields may be perceived differently (i.e. not detected) by sensitive marine organisms compared to the persistent, static geomagnetic field generated by Earth. However, results of the experimental studies discussed above suggest that it is likely that sea turtles are able to detect DC magnetic fields emitted from undersea cables within the vicinity of 50 m above and out to 68 m horizontally from the cables.

Potential Effects On Sea Turtles

Many displacement and sensory manipulation experiments have proven that changes in field intensity and inclination angle can cause turtles to deviate from their original direction. The mechanisms for sea turtles sensory abilities are not known and to date, there are no data on impacts from magnetic fields from underwater cables for sea turtles. Hatchlings and juveniles that utilize relatively shallow, nearshore waters near power cables would not be able to avoid magnetic field alterations potentially extending 50m from the bottom, and may therefore be vulnerable (Table 4.2-15). Avoidance of alterations in the magnetic field would also be unavoidable for juveniles and adults foraging on the bottom within range (up to 68m along the sea floor) of the power cables.

Sea turtles are known to use multiple cues (both geomagnetic and nonmagnetic) for navigation and migration. However, conclusions about the effects of magnetic fields from power cables are still hypothetical as it is not known how sea turtles detect or process fluctuations in the earth's magnetic field. In addition, some experiments have shown an ability to compensate for "miscues," so the absolute importance of the geomagnetic field is unclear.

4.2.5.3 Priority Species by Region

All sea turtles were identified as priority species based on existing evidence for magnetosensitivity in comparison to expected magnetic fields from undersea power cables, along

Table 4.2-15

Characteristics of sea turtles in US waters and behaviors potentially affected by exposure to magnetic fields.

Species	Common Name	Status	Life Stage	Habitat ^a	Depth ^a (m)	Behavior Potentially Affected
Class Reptilia, Order Testudines, Family Cheloniidae						
<i>Caretta caretta</i>	loggerhead turtle	T	adults		233 ^b	navigation, migration
			subadults	open ocean/neritic	0 - >200	navigation, migration
<i>Chelonia mydas</i>	green turtle	E/T	adults, hatchlings	nesting beaches	to shore	navigation, migration, orientation
			adults, juveniles	coastal/benthic	0 - 20	navigation, migration
			adults, juveniles	convergence zones/open ocean	110 ^b	navigation, migration
<i>Eretmochelys imbricata</i>	hawksbill turtle	E	post hatchlings	<i>Sargassum</i> rafts	>100	navigation, migration, orientation
			juveniles, adults	coastal/benthic	0 – 20	navigation, migration
<i>Lepidochelys kempii</i>	Kemp's ridley turtle	E	juveniles, adults	coastal/benthic	0 – 50	navigation, migration
<i>Lepidochelys olivacea</i>	olive ridley turtle	E/T	adults	open ocean	290 ^b	navigation, migration
Class Reptilia, Order Testudines, Family Dermochelyidae						
	leatherback turtle	E	adults, hatchlings	nesting beaches	to shore	navigation, migration, orientation
<i>Dermochelys coriacea</i>			adults	open ocean; seasonally coastal	>1000 ^b / 0<20	navigation, migration

^a Citations for habitat and depth data provided in Appendix C-9

^b Maximum dive depth recorded

with the fact that all sea turtles in US waters are federally listed under the Endangered Species Act.

All life stages of sea turtles use the coastal zone during their life; hatchlings when migrating offshore, and juveniles and adults when feeding and migrating between foraging grounds and breeding/nesting sites. Geographic areas of the highest use for the hatchling stage within the U.S. occur from North Carolina to Texas. Coastal feeding areas occur from Massachusetts to Texas, and from Washington to southern California (Table 4.2-16), with important foraging grounds in North Carolina, Chesapeake Bay, and Delaware Bay (Appendix Table C-13). The only geographic region where undersea power cables would be irrelevant to sea turtles is in north and northwest Alaska, where sea turtles are not found.

Sea turtles are highly migratory, and depending on life stage, may be found in nearshore or oceanic waters, or transiting between habitats from Massachusetts to Texas and Washington to California. Within these regions, exposure to magnetic fields from undersea power cables is most likely during hatchlings' movement from natal beaches to the oceanic zones because these turtles cannot avoid magnetic fields from power cables that may be intersecting with the shore near nesting sites. Exposure is also likely for foraging juveniles and adults because of their proximity to the bottom and for adults engaged in nearshore mating behavior and females

Table 4.2-16

Geographic distribution of sea turtles within BOEMRE planning areas and regions of Alaska.

Species	Common Name	Geographic Region ^a													
		North Atlantic	Mid Atlantic	South Atlantic	Straits of Florida	Eastern Gulf of Mexico	Central Gulf of Mexico	Western Gulf of Mexico	Southern California	Central California	Northern California	Washington/Oregon	Alaska (Aleutian Islands)	Alaska (Frontier)	Alaska (Northslope)
Cheloniidae															
<i>Caretta caretta</i>	loggerhead turtle	x	x	x	x	x	x	x	x	x	x	x	x		
<i>Chelonia mydas</i>	green turtle	x	x	x	x	x	x	x	x	x	x	x	x		
<i>Eretmochelys imbricata</i>	hawksbill turtle	x	x	x	x	x	x	x							
<i>Lepidochelys kempii</i>	Kemp's ridley turtle	x	x	x	x	x	x	x							
<i>Lepidochelys olivacea</i>	olive ridley turtle								x						
Dermochelyidae															
<i>Dermochelys coriacea</i>	leatherback turtle	x	x	x	x	x	x	x	x	x	x	x			

^a see Figure 1.0-1; Citations for range data provided in Appendix C-10

coming ashore to lay eggs because intensity of magnetic fields from power cables may be within their sensitivity range through much of the water column.

4.2.5.4 Case Study of the Loggerhead Sea Turtle *Caretta caretta*



Figure 4.2-6. Loggerhead turtle.

Loggerhead sea turtles (Figure 4.2-6) are listed as threatened, with some distinct populations in the North Pacific and Northwest Atlantic proposed for listing as endangered. This species is globally distributed (Figure 4.2-7) and considered the most abundant sea turtle species in U.S. waters. Loggerheads are known to occur within the U.S. Outer Continental shelf in the Atlantic from Massachusetts to Florida, in the Gulf of Mexico from Florida to Texas, and in the Pacific from Alaska to California (Waring et al. 2009). Loggerhead nesting beaches occur in various numbers from North Carolina to Texas, with the most important nesting sites

in the western hemisphere found in Florida (NMFS 2010a).

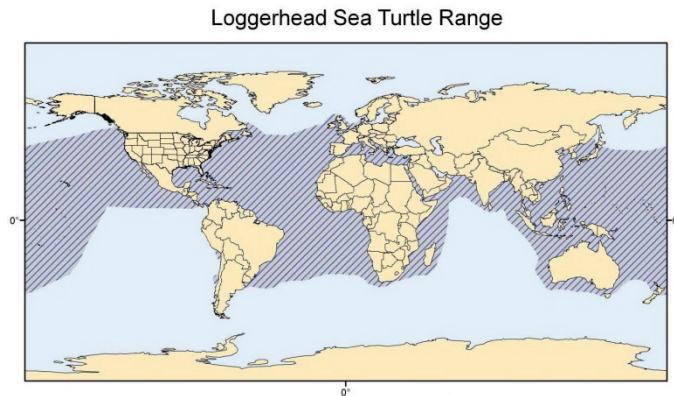

Figure 4.2-7. Worldwide distribution of loggerhead turtles (NMFS 2010a)

Multiple experimental (displacement and magnetic field manipulation in the laboratory) studies have been conducted to determine whether loggerhead sea turtles are able to sense the geomagnetic field. The consensus of these studies suggests that loggerheads (and presumably other sea turtles) use geomagnetic sensitivity (in addition to other non-magnetic cues) for orientation, navigation, and migration (Lohmann et al. 2008c). More specifically, studies have documented these turtles' ability to

use the Earth's magnetic field for compass-type (i.e. directional, to maintain a heading in a particular direction), and the more complex, map-type (i.e. positional, to assess position relative to a specific geographic location; Lohmann et al 2008b) orientation. Additionally, magnetite has been isolated in another cheloniid species, the green sea turtles.

Hatchling loggerheads were exposed to magnetic fields that replicated those found in three widely separated oceanic regions within the North Atlantic Gyre. Lohmann et al. (2001) found that the sea turtles responded by swimming in directions that they normally would to stay within the gyre. For example, turtles exposed to a field inclination similar to that of the southeastern gyre oriented to the northwest in order to stay within the gyre's boundaries. These results indicated that magnetic fields function as navigational markers and elicit changes in swim direction at crucial geographic boundaries (Lohmann et al. 2008c).

In another study, hatchling swim directions were examined under two conditions. Turtles in the experimental group were exposed to pulsed magnetic fields ($0.04 \mu\text{T}$) while turtles in the control group were not exposed to these fields. Both groups were tested in dark and light conditions (LED placed on the east side of the experimental tank to imitate the sun; Irwin and Lohmann 2005). Under light conditions, both groups oriented toward the light source (as they would in natural conditions using visual cues). In dark conditions (during which turtles normally orient magnetically), the control group's swim direction was significantly oriented toward the offshore migratory direction, while those exposed to magnetic pulses did not orient in any particular direction (i.e. swim direction was random). According to Irwin and Lohmann (2005), one possible interpretation of these results is that the magnetic pulses might have prevented the turtles from accurately assessing the magnetic position that is normally associated with specific regional magnetic fields.

Loggerheads utilize the nearshore coastal waters within the U.S. during all stages of their lives. Potential exposure to magnetic fields emitted by undersea power cables may occur during 1) adults' long migrations between nesting and foraging sites, 2) hatchlings' movement to oceanic gyres, and 3) juveniles' first return to inshore feeding areas after up to 12 years in the oceanic zone. As benthic feeders in coastal waters, juveniles of this species are likely to spend 80 to 94 % of its time below the sea surface (Lutcavage and Lutz 1997). Some areas within these

nearshore waters are critically important foraging grounds for juveniles including Cape Hatteras, North Carolina, Chesapeake Bay, Delaware Bay, and Long Island Sound (Oceana 2010).

The Earth's magnetic field within the U.S. is around 50 μT . Evidence of geomagnetic sensitivity for loggerheads has been documented as ranging from 0.00469-4000 μT (Goff et al. 1998; Avens and Lohmann 2003). Depending on the orientation of the cable relative to the geomagnetic field, DC-induced magnetic field intensities from undersea cables in existing projects are predicted to be within this range in an area at least 50 m directly above the cable and up to 68 m to either side of the cable on the seafloor (Table 4.2-6).

Conclusion

Available information suggests that magnetic fields from DC cables oriented so that they alter the natural magnetic fields by at least 0.05 μT might affect the detection systems of turtles over short distances. This would be a problem if they were not able to compensate or if all other cues (e.g. daylight) were lacking. One could speculate that this could be an issue for hatchlings (weak swimmers) attempting to leave the nest beach at night because it could disrupt their offshore migration, although this has not been studied. That risk could be remedied by not siting power cables near known nesting beaches (in areas of Virginia to Florida). Another possibility, also not studied, is that exposure could also be an issue for juveniles foraging on benthic organisms, not only because of the proximity to the cables during foraging, but due to the potential extent of magnetic fields vertically from the bottom up to 50m, which in some locations may be the entire water column. Lohmann et al. (2008b) hypothesized that navigation of juvenile and adult sea turtles depends on the phase of the migration: initially they rely on their magnetic map sense but once they near their destination they rely more heavily on local cues, most likely olfactory signals. Thus, while a localized perturbation in the geomagnetic field caused by a power cable could alter the course of a juvenile or adult loggerhead turtle, it is likely that the maximum response would be some, probably minor, deviation from a direct route to their destination.

4.2.6. Invertebrates

4.2.6.1 Review of Existing Information

Existing information provides evidence of responses to electric or magnetic fields in at least three marine invertebrate phyla (Mollusca, Arthropoda, and Echinodermata). This evidence is discussed below, followed by a discussion of invertebrate species that are targeted for review in this report.

Evidence Basis for Sensitivity to EMFs

Evidence for sensitivity to EMFs comes from physiological and behavioral studies on a small number of marine or aquatic invertebrates. Table 4.2-17 provides a listing of species from US waters and relevant groups around the world for which information on sensitivity to electric or magnetic fields has been reported (see also Appendix Table C-14). Biological effects studies have demonstrated responses to magnetic fields in the development of echinoderm embryos and in cellular processes in a marine mussel (Table 4.2-17). These toxicity studies involved high intensity fields, beyond the range of those expected from undersea cables, and are not discussed

further herein. Sections below review electroreception and magnetoreception in marine invertebrates.

Electroreception

Very few studies have investigated electroreception in invertebrates. A decade ago, Bullock (1999) speculated that invertebrate groups such as molluscs, arthropods, or even annelids may well possess an electric sense; although researchers had yet to look for it. Two recent studies claim to have reported the first evidence of an invertebrate behavioral response to an electric field. Patullo and Macmillan (2007) reported a behavioral response in a freshwater crayfish (*Cherax destructor*) to low-level electrical fields of the type generated by potential prey items and conspecifics. Crayfish exhibited an attraction response to DC electric fields producing current densities of $0.4 \mu\text{A}/\text{cm}^2$ (equates to about 3 to 7 mV/cm as per Steullet et al. 2007). Additional experiments looked at responses immediately upon stimulus onset, which evoked behavioral responses including movements of the claws, antennae, or legs. These immediate movements were often followed by walking or spreading of the claws. Studies of another freshwater crayfish (*Procambarus clarkii*) also demonstrated responses to electric fields – though at higher intensities (Steullet et al. 2007). Stimulation of *P. clarkii* with electric fields at DC, 4 Hz, 10 Hz, 100 Hz, and 1000 Hz stimulated behavioral responses only to fields at 20 mV/cm or greater. The strongest responses to the electric field were reported at 4 Hz. Electrophysiological recordings of sensory afferents showed responses to food odors and mechanical stimulation, as well as to electric fields, which suggested to the investigators that electric fields stimulate chemo- and mechano-sensory neurons, not specialized electric field receptors, and therefore electric fields may not be sensed for the detection of prey.

The functional roles hypothesized for an invertebrate electrosense would be the same as those demonstrated for fish. Prey detection is suggested as the primary function while the identification of predators and conspecifics are other possible roles. Patullo and Macmillan (2007) concluded that their investigations with crayfish provide evidence for an electrosense capable of such functions, while Steullet et al. (2007) responded that such evidence remains lacking for invertebrates.

Magnetoreception

Experimental evidence demonstrates magnetoreception in marine molluscs and arthropods (Table 4.2-17). Although much of this evidence comes from work done over the past 20 years, biogenic magnetite has been known in marine molluscs for almost five decades. Lowenstam (1962) described the discovery of magnetite in denticle cappings of chitons (Polyplacophora). The author indicated that this was the first report of biogenic magnetite in a marine organism and speculated that the magnetite may function to guide the "homing instinct" of chitons. Further analyses indicated, however, that the magnetite in chiton teeth, which serves as a hardening agent, was too weakly and randomly magnetized to also function as a compass (Kirschvink and Lowenstam 1979).

Recent investigation of the magnetic sense in molluscs has focused on the nudibranch *Tritonia diomedea*. Lohmann and Willows (1987) conducted behavioral experiments with *T. diomedea* that demonstrated the ability of this species to derive directional information from the Earth's magnetic field, and to use this information for orientation. Lohmann et al. (1991) then

Table 4.2-17

Listing of marine invertebrates for which information on sensitivity to electric or magnetic fields has been reported.

Species ^a	Common Name	US? ^b	Sensitivity ^c	Sensory Range	Evidence Basis	Citation
Phylum Mollusca, Class Gastropoda, Order Opisthobranchia, Family Tritoniidae						
<i>Tritonia diomedea</i>	sea slug	US	M	geomagnetic field	behavioral: orientation	Cain et al 2006, Lohmann and Willows 1987, Lohmann et al 1991, Popescu and Willows 1999, Wang et al 2003, Wang et al 2004, Willows 1999
Phylum Mollusca, Class Bivalvia, Order Mytiloidea, Family Mytilidae						
<i>Mytilus edulis</i>	blue mussel	US	None	n/a	none: toxicity study - no lethal effects from exposure to 3.7 mT DC fields for 7 weeks	Bochert and Zettler 2004
<i>Mytilus galloprovincialis</i>	Mediterranean mussel	Not in US	M	300-700 μ T	physiological	Malagoli et al 2003, Malagoli et al 2004, Ottaviani et al 2002
Phylum Arthropoda, Subphylum Crustacea, Class Malacostraca						
Order Isopoda, Family Chaetiliidae						
<i>Saduria entomon</i>	glacial relict isopod	US	None	n/a	none: toxicity study - no lethal effects from exposure to 3.7 mT DC fields for 7 weeks	Bochert and Zettler 2004
Order Isopoda, Family Idoteidae						
<i>Idotea baltica basteri</i>	marine isopod	Not in US	M	geomagnetic field	behavioral: orientation	Ugolini and Pezzani 1995
Order Amphipoda, Family Talitridae						
<i>Talorchestia martensii</i>	sandhopper	Not in US	M	geomagnetic field	behavioral	Ugolini 2006
Order Decapoda, Infraorder Caridea, Family Crangonidae						
<i>Crangon crangon</i>	North Sea prawn	Not in US	None	n/a	none: toxicity study - no lethal effects from exposure to 3.7 mT DC fields for 7 weeks	Bochert and Zettler 2004
Order Decapoda, Infraorder Astacidea, Family Nephropidae						
<i>Homarus vulgaris</i>	European lobster	Not in US	none	n/a	none: No neural response to 500 Hz 0.2 T or a 50 Hz 0.8 T magnetic field	Ueno et al 1986

Table 4.2-17. Listing of marine invertebrates for which information on sensitivity to electric or magnetic fields has been reported (continued).

Species ^a	Common Name	US? ^b	Sensitivity ^c	Sensory Range	Evidence Basis	Citation
Order Decapoda, Infraorder Astacidea, Family Cambaridae						
Order Decapoda	Crayfish	Not in US	M	1-400 μ T, 0.001-100 Hz	physiological: neural response	Uzdensky et al 1997
<i>Procambarus clarkii</i>	freshwater crayfish (Southeastern US)	Not in US	E	20 mV/cm; 8.08 mT	behavioral/ physiological	Delgado 1985, Steullet et al 2007, Ye et al 2004
Order Decapoda, Infraorder Astacidea, Family Parastacidae						
<i>Cherax destructor</i>	Australian freshwater crayfish	Not in US	E	current densities of 0.4 μ A/cm ²	behavioral	Patullo and Macmillan 2007
Order Decapoda, Infraorder Palinura, Family Palinuridae						
<i>Panulirus argus</i>	Caribbean spiny lobster	US	M	geomagnetic field	behavioral/ anatomical	Boles and Lohmann 2003, Lohmann 1984, Lohmann 1985, Lohmann et al 1995
Order Decapoda, Infraorder Brachyura, Family Panopeidae						
<i>Rhithropanopeus harrisi</i>	round crab	US	None	n/a	none: toxicity study - no lethal effects from exposure to 3.7 mT DC fields for 7 weeks	Bochert and Zettler 2004
Phylum Echinodermata, Class Echinoidea, Order Temnopleuroida, Family Toxopneustidae						
<i>Lytechinus pictus</i>	sea urchin	US	M	30 mT	physiological: embryonic development	Levin and Ernst 1997
Phylum Echinodermata, Class Echinoidea, Order Echinoidea, Family Strongylocentrotidae						
<i>Strongylocentrotus purpuratus</i>	purple sea urchin	US	M	30 mT	physiological: embryonic development	Cameron et al 1993, Levin and Ernst 1997

^aSpecies listed alphabetically within family

^bUS = species occurs in US waters; Not in US = species does not occur in US waters

^cM = magnetosensitivity; E = electrosensitivity; none = study found no indication of sensitivity

investigated the neural mechanisms behind these capabilities. Pedal neurons in the brain responded with enhanced electrical activity to changes in the geomagnetic field. The authors hypothesized that the neurons identified (left and right pedal 5) are part of the underlying pathway for the magnetic sense or for geomagnetic orientation. With its large, identifiable pedal neurons, *T. diomedea* is a model organism for such electrophysiological analyses of neural mechanisms for the magnetic sense. Further investigations with *T. diomedea* have identified additional pedal neurons as well as neuropeptides involved with the magnetosensory system (e.g., Popescu and Willows 1999, Wang et al. 2003, Wang et al. 2004, Cain et al. 2006). Other studies have revealed possible functional roles for magnetoreception in *T. diomedea*. Willows (1999) investigated if and why this nudibranch orients using the Earth's magnetic field in its natural environment. Animals were displaced from their original locations by SCUBA divers and movement was monitored over two or more tidal cycles. Most animals appeared to use geomagnetic cues to move in a shoreward direction (relative to geomagnetic field cues at the collection sites, though not necessarily shoreward at the release site). The author suggested that shoreward movement may represent an adaptation to frequent dislodgement by tidal currents and during predator escape responses, which enables *T. diomedea* to remain close to food sources and mates that are located in nearshore habitats. A study of macrobenthos over and around the SwePol DC cable did not find any obvious change in the species composition, abundance, or biomass one year after construction suggesting that the magnetic field in the vicinity of the cable did not affect benthic resources (Andrulewicz et al. 2003).

Magnetoreception has also been reported for several groups of marine arthropods. Much of the work has been done with the Caribbean spiny lobster (*Panulirus argus*) and is discussed later in this section in a case study on this species. Ugolini and Pezzani (1995) demonstrated that the marine isopod, *Idotea baltica basteri*, also possesses a magnetic compass. Their findings indicated that this species uses the Earth's magnetic field to orient relative to the shoreline and that it can change its magnetic compass set point based on local cues. Some evidence for a possible magnetic sense in amphipods has also been reported. Ugolini (2006) conducted experiments in which cancellation of the geomagnetic field increased body movements in *Talorchestia martensii*, that were described as “scanning” for the magnetic field. In contrast, exposure to a 50 Hz 0.8 T magnetic field, a field strength five orders of magnitude higher than expected directly over an “average” buried power cable (Section 4.1.3.1), elicited no response in an isolated gigantic axon from the common lobster (*Homarus vulgaris*) (Ueno et al. 1986).

The functional role for the invertebrate magnetic sense is hypothesized to be for orientation, navigation, and homing using geomagnetic cues (e.g., Lohmann et al. 2007, Cain et al. 2005). Use of the magnetic sense for these functions could explain the ability of spiny lobsters to navigate during migration and to locate their home den (see case study).

Preliminary Listing of Invertebrate Species

Based on evidence for sensitivity to either electric or magnetic fields along with conservation or management status, 24 species of invertebrates from four phyla were initially targeted for review in this report. Either direct evidence for these species, or evidence for a closely related taxon, suggested that these species should be prioritized for consideration of potential sensitivity to EMFs. Appendix Table C-14 provides summarized sensitivity findings in a phylogenetically ordered listing of these species. This listing also includes invertebrates from elsewhere

throughout the world for which information on sensitivity to electric or magnetic fields has been reported. Thus, findings on sensitivity to electric or magnetic fields can be compared among related species within this table.

Table 4.2-18 presents federally listed threatened or endangered marine invertebrate species (NMFS 2010a). These species were included in the preliminary listing of invertebrates regardless of reported sensitivities to ensure careful consideration throughout the process of analyzing potential effects of EMFs.

Table 4.2-18

Federally listed threatened (T) or endangered (E) marine invertebrates in US waters (NMFS 2010a).

Species	Common name	Status	Comments
Phylum Cnidaria, Class Anthozoa, Order Scleractinia, Family Acroporidae			
<i>Acropora cervicornis</i>	staghorn coral	T	listed in 2006
<i>Acropora palmata</i>	elkhorn coral	T	listed in 2006
Phylum Mollusca, Class Gastropoda, Order Archaeogastropoda, Family Haliotidae			
<i>Haliotis cracherodii</i>	black abalone	E	listed in 2009
<i>Haliotis sorenseni</i>	white abalone	E	listed in 2001

4.2.6.2 Effects of EMFs from Undersea Power Cables

Comparison of expected EMF levels to reported sensitivities

Much of the work on magnetoreception in invertebrates has involved manipulation of the Earth's magnetic field (generally ~50 μ T), and precise sensitivity levels to magnetic fields are not well known (Table 4.2-17). Nonetheless, based on reported sensitivities and theoretical levels for other groups of animals, sensitivities for invertebrates are also likely to be below 100 nT (Kirschvink and Gould 1981, Lohmann and Lohmann 1996b, Walker et al. 1984). As discussed in Section 4.2.6.1, little is known about electroreception in invertebrates. Reported sensitivities to electric fields for invertebrates range from around 3 to 20 mV/cm (Steullet et al. 2007).

AC magnetic fields from cables in the US would have a frequency of 60-Hz. As discussed for other organisms believed to have a magnetite-based receptor system, invertebrates also may not respond to fields in this frequency range, especially at intensities below 5 μ T (see discussion in case study). Modeling results provided in Appendix Table B-10 suggest that a magnetoreceptive invertebrate would need to be within two meters of a cable to encounter a 60-Hz magnetic field at intensities above 5 μ T from a cable buried one meter and carrying 1,000 A. Directional information from a time-varying field would also fluctuate, and data to suggest how invertebrates may respond to this is lacking. AC cables would also generate induced electric fields that may be detected by electroreceptive invertebrates. The induced AC electric field intensities in Appendix Table B-3 for the smallest modeled fish (much larger than most invertebrates) are well below reported sensitivity thresholds for invertebrates.

The evidence suggests that a magnetite-based mechanism could detect variations in the ambient geomagnetic field produced by the magnetic field from a DC cable. Thus, invertebrate species that can detect the Earth's geomagnetic field would likely detect changes to the field in the vicinity of a DC cable. As illustrated by comparing Figures 4.1-11 and 4.1-12, the total DC field (geomagnetic + cable) that would be sensed by an organism would depend upon the magnitude of the magnetic field from the cable in combination with the ambient geomagnetic field. The resulting field is highly dependent upon the cable's orientation relative to the Earth's magnetic field. Therefore, the total DC field of a cable is project and site specific. Induced electric fields from ocean currents moving through the DC magnetic field would likely be below the sensory range reported for invertebrates (Table 4.1-4).

Potential Impacts to Invertebrates

No direct evidence of impacts to invertebrates from undersea cable EMFs exists. Few marine invertebrates have ever been evaluated for sensitivity to electric or magnetic fields; and the available data for those that have been studied are limited. In addition, these magneto-orientation studies are focused on the behavior of mobile adults and the effects on their pelagic larval stages are poorly studied. Thus, a discussion of potential impacts to invertebrates from anthropogenic EMFs must rely on speculation and very likely overlooks a number of sensitive species. Nonetheless, what's known about invertebrate sensitivities in comparison to expected EMF levels provides some guidance for considering potential impacts. Potential impacts to invertebrates from EMFs for a particular undersea cable would depend upon the sensory capabilities of a species, the life functions that its magnetic or electric sensory systems support, and the natural history characteristics of the species. Life functions supported by the electric and magnetic sense indicate that species capable of detecting magnetic fields face potential impacts different from those that detect electric fields.

Electrosensitive invertebrate species that have so far been identified have sensitivity thresholds above the modeled level of induced electric fields from undersea cables, and would therefore not be impacted by those fields. Any impacts to magnetosensitive species from an altered magnetic field in the vicinity of a cable would depend upon how a species uses its magnetic sense. As with fish, invertebrate species that use the geomagnetic field to guide their movements through an area with a undersea cable may be confused as they encounter the magnetic field from the cable (Gill and Kimber 2005). They may change their direction of travel based on the altered field. Some invertebrates may use a magnetic sense for orientation or homing within a relatively small local range, and homing capabilities that are based on a magnetic sense could be affected in close proximity to certain cable systems.

4.2.6.3 Priority Species by Region

Based on existing evidence of sensitivity in comparison to expected levels of EMFs from undersea cables, those species most likely to sense EMFs were identified as "priority species" for the final level of assessment based on natural history attributes. Using these criteria, six species that occur in US coastal waters were identified as priority. An additional three species for which there is little or no information documenting their sensitivity to EMFs has also been included as

priority species because of their commercial or ecological importance. Natural history characteristics for these species are provided in Table 4.2-19, and their distribution within BOEMRE planning areas is shown in Table 4.2-20. Additional life history information including geographic distribution is in Appendix Tables C-15 and C-16.

Table 4.2-19

Characteristics of priority invertebrate species in US waters and behavior potentially affected by exposure to electric or magnetic fields.

Species	Common Name	Status	EFH	Habitat	Depth (m)	Behavior Potentially Affected
Phylum Mollusca, Class Gastropoda, Order Opisthobranchia, Family Tritoniidae						
<i>Tritonia diomedea</i>	sea slug			benthic	shallow sublittoral to 750	orientation
Phylum Arthropoda, Subphylum Chelicerata, Class Merostomata						
<i>Limulus polyphemus</i>	horseshoe crab			benthic	intertidal to 20	orientation or navigation
Phylum Arthropoda, Subphylum Crustacea, Class Malacostraca						
Order Decapoda, Infraorder Palinura, Family Palinuridae						
<i>Justitia longimanus</i>	West Indian furrow lobster			benthic	1 to 300 (usually between 50 and 100)	orientation or navigation
<i>Panulirus argus</i>	Caribbean spiny lobster		G, SA	benthic	shallow water; occasionally to 90 m or more	orientation or navigation
<i>Panulirus guttatus</i>	Spotted spiny lobster			benthic	shallow water	orientation or navigation
<i>Panulirus interruptus</i>				benthic	shallow to 65	orientation or navigation
<i>Panulirus laeviscauda</i>	Smoothtail spiny lobster			benthic	shallow to 50	orientation or navigation
Order Decapoda, Infraorder Astacidea, Family Nephropidae						
<i>Homarus americanus</i>	American lobster			benthic	shallow to 40	orientation or navigation
Order Decapoda, Infraorder Brachyura, Family Cancridae						
<i>Metacarcinus magister</i>	Dungeness crab			benthic	up to 100	orientation or navigation

^a Citations for data sources provided in Appendix Table C-15

^b T = threatened; E = endangered

^c EFH = Essential Fish Habitat, designated by Gulf of Mexico (G) or South Atlantic (SA) Fisheries Management Council (NMFS 2010b)

The natural history characteristics of a species indicate to what extent that species may inhabit an area in which it would encounter EMFs from cables. Several important attributes allow for the identification of species that are likely to be at higher risk of effects from EMFs than others. First, benthic species live in close association with the seafloor where the highest EMF levels from undersea cables would be encountered. In contrast, pelagic species living within the water column are less likely to come in contact with the highest intensity fields. Also by comparison to pelagic invertebrates, benthic species are less mobile and inhabit a smaller home range. This

potentially leads to higher exposures to magnetic fields from a power cable installed within their home area. A second attribute of importance is a species' distribution relative to the coastline and to depths in which offshore renewable energy facilities are most likely to be constructed. Near-shore and coastal species with bottom depth distributions to less than 100 meters are more likely to encounter cables than are those species residing in deeper waters, especially those occurring off the continental shelf in depths greater than 200 meters. A third important attribute is the geographic distribution of a species, which indicates whether that species is known to occur in the area of a particular proposed project (Table 4.2-20).

Species with the highest conservation status or fisheries management status must be given top priority in the process of assessing potential impacts. Four invertebrate species are federally listed as threatened or endangered (Table 4.2-18). Sensitivity to electric or magnetic fields has not been reported for any of these species or for their close relatives, and these were therefore not considered priority species. Essential Fish Habitat (EFH) has been designated for *Panulirus argus* as indicated in Table 4.2-19. Additional natural history attributes such as species movement (whether they are migratory or non migratory) or changes in distribution patterns related to life stage or season are provided for priority species in Appendix Table C-15.

Factors that help to determine the risk for potential impact to invertebrates from EMFs vary greatly at each level of consideration including (1) physical factors (e.g., cable system attributes that determine EFH levels), (2) biological factors (e.g., sensitivity levels for various species), and (3) ecological factors (e.g., natural history attributes for various species). Thus, project and site specific analyses of potential EMF impacts to local invertebrate species are essential. A case study that addresses considerations for assessing potential EMF effects is provided for a representative invertebrate (Caribbean spiny lobster).

4.2.6.4 Case Study of the Caribbean Spiny Lobster *Panulirus argus*



Figure 4.2-8. Caribbean spiny lobster.

The Caribbean spiny lobster (*Panulirus argus*; also “western Atlantic spiny lobster”; Figure 4.2-8) was selected for a case study on how physical data for EMF levels could be compared to the biological data on sensitivity and natural history, to assess potential effects to invertebrate species. *P. argus* is one of five commercially important species in the family Palinuridae that are found in US coastal waters (Table 4.2-20). The Gulf of Mexico Fisheries Management Council has identified EFH for this species off the southern tip and along the west coast of Florida (Figure 4.2-9; GMFMC 2004).

Table 4.2-20

Geographic distribution of priority invertebrate species within BOEMRE planning areas and regions of Alaska.

Species	Common name	Geographic region													
		North Atlantic	Mid Atlantic	South Atlantic	Straits of Florida	Eastern Gulf of Mexico	Central Gulf of Mexico	Western Gulf of Mexico	Southern California	Central California	Northern California	Washington/Oregon	Alaska (Aleutian Islands)	Alaska (Frontier)	Alaska (Northslope)
Phylum Mollusca, Class Gastropoda, Order Opisthobranchia, Family Tritoniidae															
<i>Tritonia diomedea</i>	sea slug									x	x	x	x	x	
Phylum Arthropoda, Subphylum Chelicerata, Class Merostomata															
<i>Limulus polyphemus</i>	horseshoe crab	x	x	x	x	x	x	x							
Phylum Arthropoda, Subphylum Crustacea, Class Malacostraca															
Order Decapoda, Infraorder Palinura, Family Palinuridae															
<i>Justitia longimanus</i>	West Indian furrow lobster				x	x									
<i>Panulirus argus</i>	Caribbean spiny lobster		x	x	x	x	x	x							
<i>Panulirus guttatus</i>	Spotted spiny lobster				x										
<i>Panulirus interruptus</i>	California spiny lobster								x						
<i>Panulirus laevicauda</i>	Smoothtail spiny lobster				x										
Order Decapoda, Infraorder Astacidea, Family Nephropidae															
<i>Homarus americanus</i>	American lobster	x	x	x											
Order Decapoda, Infraorder Brachyura, Family Cancridae															
<i>Metacarcinus magister</i>	Dungeness crab									x	x	x	x	x	x

Information in the following paragraphs on sensitivity and natural history suggests that *P. argus* should be considered a priority species for further consideration of potential effects from undersea cable EMFs.

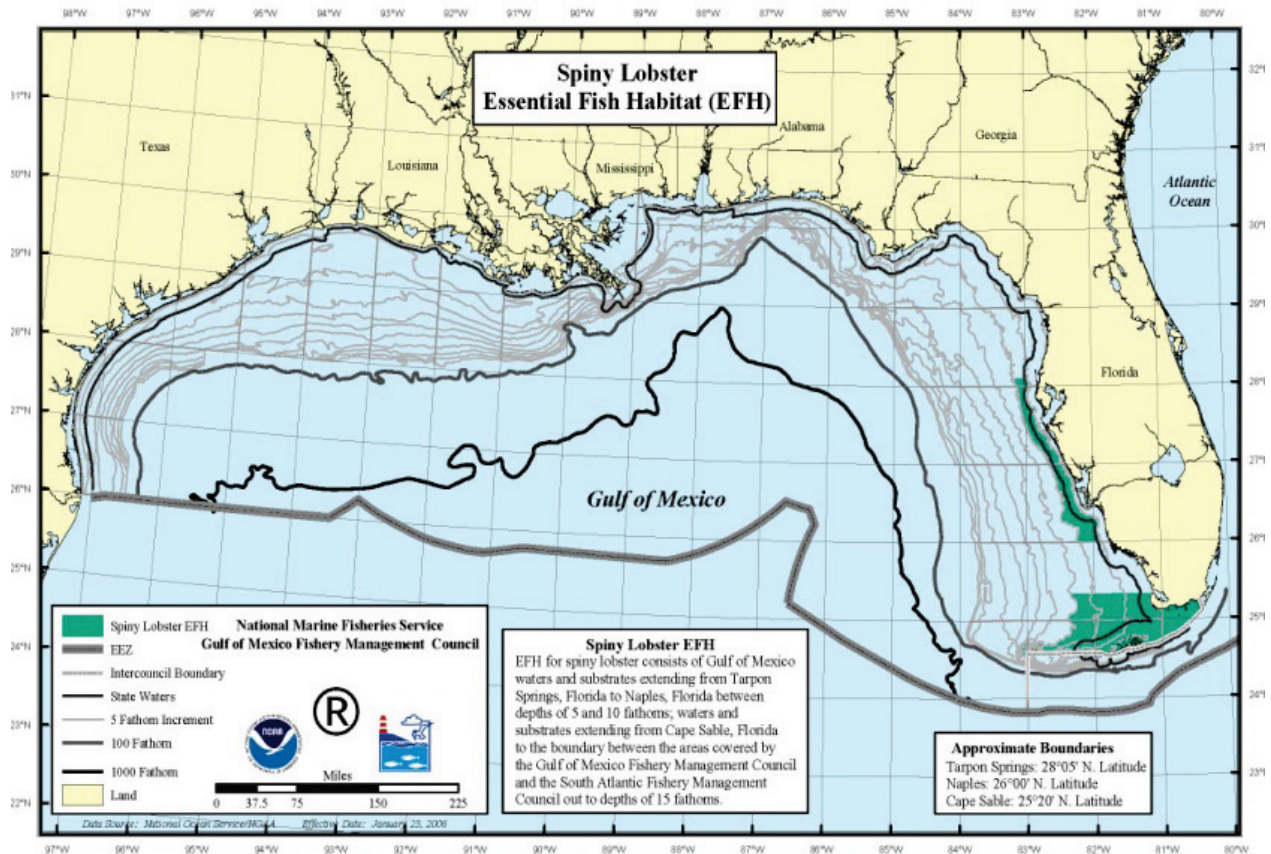

Figure 4.2-9. Spiny Lobster EFH (GMFMC 2004)

Lohmann (1984) reported finding ferromagnetic material in *P. argus*. The material was concentrated in the cephalothorax, in tissue associated with thoracic ganglia. The author speculated that the functional role for these permanent magnetic particles may relate to a compass mechanism for a magnetoreceptor system. Follow-on work by Lohmann (1985) involved conditioning experiments to test if *P. argus* could orient using geomagnetic cues. The author reported that conditioned lobsters entered north-south aligned tunnels in the experimental chambers significantly more often than other tunnels, but the lobsters did not discriminate north from south in these experiments. When a pair of conditioned lobsters was subjected to an altered magnetic field, the lobsters shifted to the new north-south magnetic axis, confirming the use of magnetoreception and providing evidence that *P. argus* can use the Earth's magnetic field as a directional cue. Further investigation confirmed that lobsters exposed to a reversal of the horizontal geomagnetic field altered their orientation (Lohmann et al. 1995). This work also established that lobsters respond to the horizontal component of the geomagnetic field and not to the vertical component, a finding that is consistent with the hypothesis that lobsters have a polarity compass not an inclination compass. Tagging and displacement studies were then conducted by Boles and Lohmann (2003), who moved lobsters to an unfamiliar location to investigate orientation relative to true navigation capabilities. The orientation of lobsters transported to different locations was consistent with the use of the geomagnetic field for navigation. Additional experiments using artificially replicated geomagnetic fields confirmed this finding. Boles and Lohmann (2003) concluded that *P. argus* is capable of true navigation

based on a magnetic map sense. The significance and implications of these studies on the magnetic sense and its functional roles in *P. argus* are discussed by Alerstam (2003), Cain et al. (2005), and Lohmann et al. (2007). Together, the available evidence suggests that *P. argus* can sense the Earth's magnetic fields and use this information for navigation and homing.

Spiny lobsters exhibit natural history traits that could expose them to magnetic fields from undersea cables. *P. argus* is a benthic species living in direct contact with the sea floor where the highest intensity magnetic fields from cables would be experienced. *P. argus* is also a coastal species, preferring shallow depths, but found occasionally down to 90 meters or more (Holthuis 1991). This depth range overlaps with the near-shore areas in which cables from offshore renewable energy projects may be installed. The geographic range of this species in US waters extends from North Carolina southward in the Atlantic and throughout the Gulf of Mexico (Holthuis 1991). This distribution includes areas in which offshore wind and offshore ocean current facilities are already being considered (Michel et al. 2007). Furthermore, the functional role for the magnetic sense in *P. argus* appears to support the well documented annual migrations and homing capabilities of this species. During mass migrations of spiny lobster that occur each autumn, thousands of lobsters have been reported moving in single-file lines of consistent compass headings from inshore areas to deeper waters (Lohmann et al. 1995). Lobsters foraging at night have also been reported to follow straight-line paths from their foraging areas several hundred meters to their specific den locations in rock or coral reefs where they hide out by day (Lohmann et al. 1995). Both migration and homing activities could occur in areas where transmission cables may be proposed.

The typical configuration for submarine cables that carry electricity from offshore wind facilities to shore is to use AC cables. Thus, these cables are sources of AC magnetic fields (the metallic sheaths and armoring of the cable block the electric field of the conductors from reaching the environment), which in the US would have a frequency of 60-Hz. Although no studies of lobster sensitivity to AC magnetic fields were found in the literature, one would not expect a magnetite-based detection mechanism to respond to weak AC magnetic fields because the rate of change of the field would be too rapid for the magnetite to respond mechanically to the imposed force. Adair (1994) calculated that 60-Hz magnetic fields greater than 5 μT would be required to exceed forces on magnetite particles from thermal motion alone. Using this calculation as a rough guide for inference, one might hypothesize that AC magnetic fields would need to be greater than 5 μT to be detected by a magnetite detection system of a lobster (assuming a magnetite-based system to be the mechanism at work in lobsters). Modeling results provided in Appendix Tables B-9 to B-12 suggest that a lobster would need to be within several meters of a cable to detect a 60-Hz magnetic field from a cable carrying 1,000 A.

Factors including longer transmission distances and higher power loads may lead to the use of DC cable systems as future projects are moved further offshore. There is ample evidence to suggest that a magnetite-based mechanism could detect variations in the ambient geomagnetic field produced by the DC magnetic field of the cable. Since spiny lobsters have demonstrated the capability to detect the Earth's geomagnetic field, they would likely detect changes to the field in the vicinity of a DC cable. As illustrated by comparing Figures 4.1-11 and 4.1-12, the total DC field (geomagnetic + cable) that would be sensed by an organism would depend upon the magnitude of the magnetic field from the cable (in these figures it is varied by the distance

between the cables) as well as the cable's orientation. Thus, the total DC field of a cable is highly specific to project configurations and site conditions. For a cable such as the SwePol link (see Figure 4.1-9), a field may be detectable by lobsters for over 20 meters on either side of the centerline of the cables. Variations in the local field and orientation of the cable could increase or decrease this distance.

Conclusion

The available evidence indicates an overlap in the magnetic sensitivity of *P. argus* with the expected levels of magnetic fields from certain undersea cables. This lobster occurs in areas where offshore renewable energy facilities and their transmission cables are likely to be proposed; it also exhibits natural history traits that suggest risk of effects from magnetic fields associated with power transmission. Thus, *P. argus* has the potential to be affected by EMFs from certain cable configurations although evidence to characterize the nature of such effects is lacking. The ability of lobsters to orient and navigate in the immediate vicinity of DC cables would presumably be diminished. This could result in delayed or altered migration patterns, or could interfere with homing capabilities, for lobsters living in close proximity to cables. Spiny lobsters are relatively slow moving animals that walk along the bottom unless responding to predators using tail flip escape swimming, potentially prolonging their exposure to altered geomagnetic fields. Therefore, disorientation within the range of the magnetic field surrounding some DC cables could presumably confuse or delay lobsters. Nonetheless, the lobster's ability to rely on backup orientation and navigation cues and their adaptability to change in magnetic cues is not well known. These factors could reduce the magnitude or duration of any potential impacts. Ultimately, any effects would depend greatly upon site specific and project specific factors related to both the magnitude of EMFs and the ecology of local lobster populations including spatial and temporal patterns of habitat use.

4.3 DATA GAPS AND RESEARCH PRIORITIES

While there is a large literature base pertaining to the generation of electric and magnetic fields and to some aspects of the perception by marine species of these fields, it is still difficult to draw conclusions about the ecological significance of EMF in the marine environment. Although the performance characteristics of individual cables may not be fully known, this data gap can be closed fairly easily by obtaining more specific information about cables during the permitting process as described in Section 4.3.1. This will enable a more detailed understanding of the magnitude of the spatial extent of the fields associated with the operation of each cable. The ability to interpret the effects of an operating cable on marine organisms is, however, more difficult. The literature discussed in Section 4.2 suggests that perception and responses are likely to be species-specific (or, perhaps, groups of species) and habitat-specific, and that assessment clearly requires a project-specific analysis. The stage of the knowledge does not currently allow definitive conclusions about responses by individuals, let alone impacts at a population level. Section 4.3.2 provides direction on the types of research that would help reach that level of understanding.

Acknowledgement of substantial gaps in our understanding of the effects of EMF in the marine environment should not be construed as a recommendation to avoid installation of new undersea cables until these gaps are closed however. The modeling presented in Section 4.1 is

representative of the types of existing and proposed cables that are suitable to support the offshore wind (or other types of offshore renewable energy) industry and can be used to develop at least a preliminary understanding of field strengths of proposed cables. Coupled with the available information on the ability of various species to sense these fields, it is evident that there are spatial boundaries surrounding each cable beyond which the fields are unlikely to have an effect on biota. Historical use of undersea power cables (e.g., connecting islands and oilrigs to the mainland, offshore wind projects in Europe) provides no documented evidence in the literature of major impacts to marine species from EMFs although there have been few studies that have actually assessed the interaction between marine organisms and cable EMF. Given that the offshore renewable energy industry in the US is in its infancy, it is reasonable to believe that any potential risks of exposing particularly sensitive species or populations to EMFs from undersea cables can be substantially reduced by careful site selection, mitigation, and an increased knowledge base on the sensitivities and responses of marine species to EMFs to improve siting decisions. The current hierarchy of offshore wind project development anticipated in US waters, with early emphasis on the Mid-Atlantic and New England, allows us to focus on key species and research topics.

4.3.1 Data Gaps and Research Priorities for Power Cables

This report provides new data regarding potential exposures of marine organisms to magnetic fields and induced electric fields from undersea cables as are deployed to transport power generated by wind and other offshore energy sources. While these data focus on the contribution of undersea cables to the existing electric and magnetic environment, it would be of scientific interest to confirm modeling results by measurements of the pre-construction and post-construction fields surrounding undersea cables in specific environments such as has been done on a small scale as part of a mesocosm study investigating behavior of fish in the vicinity of a cable near Loch Ceann Traigh Scotland (Gill et al. 2009). This would help to verify modeled estimates and provide empirical data upon which to evaluate potential exposures of marine species to magnetic fields from AC and DC undersea cables.

This survey of submarine cable projects indicates that very few permitting agencies have required applicants to provide detailed information about the cables to be installed, the expected fields in operation, and an assessment of potential environmental effects. Permitting agencies should require that such information be provided in applications as a minimum standard for review. Specifically, agencies should require that details of the cable design, anticipated cable depth and layout, magnetic permeability of the cable sheathing, and loading (amperes) be provided early enough in the permitting process to allow complete determination of EMF potentially generated by the cable.

No submarine cable projects were identified that explicitly incorporated any magnetic field mitigation methods into design and installation plans. Electric field monitoring was not performed because the metallic sheathing and armoring of the cables was assumed to shield the electric field from the marine environment adequately. Two projects in Connecticut, however, have reported monitoring of the magnetic fields around the cable because of a permitting requirement for reporting this information to the Connecticut Siting Council. For the Cross Sound Cable project, measurements of the DC magnetic field from the cable showed an excellent

agreement with pre-construction calculations adjusted for the current flow on the cable at the time of measurement (Exponent 2004). More recently, post-construction measurements of DC magnetic fields were reported in the vicinity of the replacement of a 138-kV AC cable system, but the authors did not relate these measurements to operation of the cable (OSI 2009). Measurement of an operational wind project 132 kV cable in the UK has shown that both magnetic and induced electric fields are emitted but they occur amongst a background of other sources of EMF (Gill et al. 2009). Post-construction monitoring of the marine environment around the offshore Nysted Wind farm in Denmark was performed but the design and methodology of the studies was inadequate to be able to ascribe behavior of fish to magnetic field strength in the vicinity of the submarine cable (DONG 2006).

A variety of commercially available sensors towed by surface vessels can be used to measure AC and DC magnetic fields produced by submarine cables during short-term field investigations. No such sensors are readily available to measure AC or DC electric fields in the marine environment and no sensors have been developed for long-term monitoring of either magnetic or electric fields produced by submarine cables. However, given the high degree of accuracy in the modeling of magnetic fields from cables, it may only be appropriate to require field monitoring for a representative group of projects to capture a range of cable characteristics to aid in model verification. Pre-construction measurements of the local geomagnetic field would be useful as input to modeling efforts for DC cables so that the net magnetic field could be predicted.

4.3.2 Data Gaps and Research Priorities for Marine Species

4.3.2.1 Data gaps

Existing data gaps prevent a clear answer to the question of how EMFs from undersea power cables may affect marine species, particularly at the population level where NEPA analysis would be focused. Some of the missing information relates to project and site-specific variability. The magnitude and characteristics of EMFs from a given cable; the diverse composition of local biological communities and their patterns of habitat; and resource usage are prime examples of project-specific unknowns. Nonetheless, uncertainty also stems from data gaps in empirical knowledge of the sensory systems and natural history of marine fauna. The existing data on the response of marine species to anthropogenic EMFs is not sufficient to identify either beneficial or negative impacts.

Strong behavioral, physiological and some anatomical evidence indicate that certain marine species can detect electric or magnetic fields. However, most of the available data for physiological and behavioral responses comes from studies designed to assess responses to natural electric or magnetic field stimuli (e.g., bioelectric fields, geomagnetic fields). Only a few studies have produced data needed to characterize responses of marine species to cable EMFs. For example, Gill et al. (2009) reported that some individuals of two of three species of benthic elasmobranchs were observed more frequently within 2 m of an experimental cable when energized than an unenergized cable. Westerberg (2000) and Öhman et al. (2007) described slowed and skewed swimming of some European eels crossing a DC cable. A critical gap in understanding the topic at hand is information to assess not just response, but potential consequences or impacts. Impacts may be beneficial or negative and can be measured in terms

of magnitude, spatial extent, and duration. Species may experience different effects by gender or life stage, and at individual or population levels. Impacts can go beyond species to ecosystem-level effects. Data are needed to characterize any such effects to the marine environment from anthropogenic EMFs.

Beyond the immediate question of whether species known to sense electric or magnetic fields may be impacted by cable EMFs, a great deal of fundamental scientific research on the electric and magnetic sense of marine organisms remains to be done. Basic questions about mechanisms behind sensory systems and application of electric or magnetic senses in life functions are unanswered. For example, little evidence is available to support the widely discussed hypothesis that the magnetic sense is used for navigation to guide long-distance migrations in some species. And it remains to be demonstrated whether sharks and rays use a magnetite-based magnetic sense or use their electric sense to detect induced electric fields associated with magnetic fields.

Little work has been done to investigate how widely distributed these senses may be across most marine groups. Even for the relatively well-studied electrosensory system of elasmobranch fishes, functional data are known for only a few test species. Work on invertebrate groups is almost entirely lacking and has focused only on the adult stage. Any investigation into the question of whether larval stages may use these senses is currently lacking (Kingsford et al. 2002).

Natural history data relevant to understanding potential effects of cable EMFs is also lacking for many species. While distribution ranges, migration or movement patterns, and habitat usage are known for many marine organisms, relatively little is known about how undersea cables might affect these life history parameters. Good information generally exists on the ranges and habitats for managed species in offshore waters. However, site specific estimates of population numbers are limited. These are needed to assess potential impacts of power cable deployments on local and transient populations.

4.3.2.2 Research priorities

Research addressing gaps in our understanding of the effects of EMF in the marine environment should be geared towards questions needed to conduct a NEPA-level impact assessment. The key question is whether EMFs from undersea power cables have a significant effect on marine organisms; whether the fields interfere with natural behavior or physiological processes to a degree that reduces the ability of populations to be sustained (and, in the case of endangered species, this could be measured at the individual level). When these questions can be answered during the NEPA process, appropriate mitigation strategies can be developed.

Mediation of potential undesirable interactions of marine species with future offshore alternative energy facilities will require more information on the life history, behavior, and sensory systems of marine species in relation to specific features of electromagnetic fields. Hypothetical assertions about the potential impacts of anthropogenic EMFs on marine organisms, populations and ecological systems should be examined with empirical tests. Of great importance, research is needed to define interactions of different marine species with undersea cables to characterize responses or effects from anthropogenic EMFs.

There are three categories of research that would be useful to fill data gaps and enhance impact analysis: (1) identification of the immediate and long-term responses of marine organisms and populations to cable EMFs, (2) collection of relevant data on the electro- and magnetosensory biology of marine species, and (3) collection of data on the natural history of potentially affected organisms. These priorities are not arranged in a hierarchical manner because adequate interpretation of small or large scale effects requires information at all three levels and data gaps vary among phylogenetic groups. These research efforts may use targeted or surrogate species in laboratory and field studies.

Priority species of concern were identified in Section 4.2 based on evidence of electro- or magneto-sensitivity. Little research has been conducted on invertebrates, so several species of epibenthic arthropods of ecological or commercial value have also been added to the priority list. For a listing of priority species for each BOEMRE planning area, refer to Tables 4.2-2 (elasmobranchs), 4.2-5 (other fish), 4.2-10 (marine mammals), 4.2-15 (sea turtles), and 4.2-20 (invertebrates). These priority species were identified as those which should be considered during NEPA analysis within each planning area. Research to advance our understanding of electro- and magnetosensitivity and response to exposure to EMFs could proceed using a subset of these species, such as those listed on Table 4.3-1.

Table 4.3-1.

Initial Research Needs by Planning Area

Region	Priority Species	Type of Research Needed		
		Response to Cable EMFs	Sensory Biology	Natural History
North Atlantic	American lobster	x	x	
Mid-Atlantic	Horseshoe crab	x	x	
	Sandbar shark (juveniles)	x		x
South Atlantic	Spiny lobster	x		
	Sea turtles (hatchlings; nesting adults)	x		
Gulf of Mexico	Shark species (benthic)	x		
	Sea turtles	x		
Pacific	Green sturgeon	x		
	Salmon species	x		
	Dungeness crab	x	x	
	California spiny lobster	x		
Alaska	Shark species (benthic)	x		
	Salmon species	x		
	Red king crab	x	x	

Little research has been done to determine whether most of the invertebrate species listed on Table 4.3-1 have a capability for sensing magnetic or electric fields. Each is regionally significant either ecologically (horseshoe crab) or economically (American lobster, spiny lobster, Dungeness crab, red king crab) and undergoes onshore-offshore movements seasonally that

could potentially be impeded by a barrier such as EMFs from an undersea power cable. If it is determined that any of these species has a sensory capability, then they should be experimentally exposed to EMFs to determine their sensitivity thresholds relative to EMF levels from undersea cables, and behavioral response. There is at least some evidence that the other species (or species groups) listed on Table 4.3-1 have a physiological mechanism that would make them sensitive to EMFs. These species could be exposed to EMFs at the levels expected from offshore renewable energy power cables to determine their sensitivity thresholds and behavioral responses. It would be important to focus this research on the life stages that would be most likely to be exposed to these cables, generally those with a coastal presence. Enough is generally known about the natural history of these species to identify the segments of the population most likely to be exposed. We recommend that the distribution and habitat use by the sandbar shark be further investigated because NMFS has identified an HAPC for this species in an area that has high potential for offshore wind project development.

Response to and Consequences of Cable EMFs

This is fundamentally the most important question to be considered in assessing the effects of the cabling from a particular offshore renewable energy project. As described in *Data Gaps* section above, there are very few peer-reviewed publications on the behavioral responses of marine organisms to power cable EMFs, and even fewer that address larger scale marine community effects. Key or closely related surrogate species with the combination of sensory capabilities, natural history attributes, and conservation/fisheries importance should be examined first. Examples of key species on the east coast of North America could include the sandbar shark, spiny lobster and loggerhead turtle although this list is not comprehensive because the distributions of magnetosensitive species differ with geographic location. Further, these species may not be conducive to some studies, thus substitute surrogate species may be studied. Research questions for study before and after offshore wind projects are constructed include:

What are the immediate behavioral responses of electro- and magnetosensitive marine vertebrates and invertebrates to active undersea power cables?

Rigorous experimental studies in controlled laboratory conditions are needed to test for finite behaviors involved in the responses of free-moving marine species to electric cable systems. Orientation, aversion and other relevant immediate behaviors of elasmobranch, bony fish and invertebrates to active AC and DC cable systems can be characterized and compared with behaviors at uncharged control cables. Perception of electromagnetic stimuli may also be identified using adjunct physiological techniques such as changes in heart or ventilation rate. Direct measures of the magnetic and induced electric fields at the location of behavioral responses should be recorded and analyzed. Combined these studies would identify stimulus thresholds for behaviors involved in detection, orientation and avoidance behaviors. It may also be possible to work with captive marine mammals such as bottlenose dolphins trained to respond to EMF stimuli from activated cables. These studies should provide important information on how individual animals respond during encounters with cable EMF stimuli, document potential response differences to AC vs. DC cable systems, and categorize stimulus-response behavior functions. This method can be used to assess for response differences related to age or life history stage (e.g. larvae, juveniles and adults) discussed below.

The best studied magnetosensitive crustacean is the Caribbean spiny lobster. If it is found to respond behaviorally to active cables, then other commercially or ecologically valuable arthropods that are known to migrate in the vicinity of or occur at wind project sites should also be screened for a magnetic sense. Examples from different regions of the country include: (1) horseshoe crab in the Mid-Atlantic, (2) American lobster in Northeast, (3) California spiny lobster in Pacific Southwest (a congener of the Caribbean spiny lobster), (4) Dungeness crab in Pacific Northwest, and (5) red king crab in Alaska.

In addition to expanding the knowledge base across taxonomic groups, research should address gaps in knowledge across life stages. Even in the relatively well studied elasmobranchs, differences in sensitivity and responses to EMF stimuli between species, sexes or life history stages are not well known. Behavioral and physiological responses to electric and magnetic stimuli are described for only a few of the 1000 species of elasmobranch fishes, and cannot be used to generalize responses for all species. Candidate species for research that represent specific taxonomic groups (e.g. the highly migratory sandbar shark, hammerhead sharks, demersal cat sharks, skates, stingrays, etc.) should be identified as model test species. Sex and age dependent responses to magnetic fields can be assessed to determine differential affects on individuals across seasons.

How are the movement patterns and distributions of marine organisms affected by wind power generation equipment?

Larger scale studies are needed to identify altered movement patterns of marine organisms that encounter activated cable systems. Powered experimental treatment and control sites such as the mesocosm COWRIE 2.0 EMF study on elasmobranchs (Gill et al. 2009) should be conducted to interpret the effects of DC and AC power cable systems on the movements and resultant distribution of priority species and populations. These should include techniques of standard mark-recapture and real time tracking (e.g., using ultra-sonic tagging) of animals to define movement patterns around cable track areas. Movements can be recorded for several animal groups known to be sensitive to magnetic stimuli such as lobster, bony fish and elasmobranchs. This method can also test for differential responses to variations in EMF emission levels.

Mesocosm studies should be complemented with observations of the movement patterns of priority or surrogate species in relation to wind generator facilities in the field. The movements of wide-ranging species that occur near existing offshore wind project and transmission cables can be monitored using real time tracking as discussed above. In addition, movements of marine mammals near cables may be recorded using archival GPS recorders (or other technologies) that log latitude and longitude position during surface intervals. Such movement data can be used for correlation and GIS analyses with active cable tracks to determine significant temporal and spatial associations.

Kirschvink's (1990) and Kirschvink et al.'s (1986) research comparing live-strandings of marine mammals to geomagnetic minima could be expanded to determine whether the presence of submarine DC cables in the vicinity of the geomagnetic minima affects the results of the correlation analyses. This could be accomplished by a desktop study requiring readily available

information and would provide a better understanding of whether DC cables pose a risk to marine mammal migrations.

What are the long-term effects of offshore wind project facilities on local marine populations?

Once offshore energy facilities are built in US waters, long-term monitoring of powered cable systems should be used to accomplish the task of characterizing effects from cable EMFs. Environmental monitoring of the distribution and abundance of magneto and non-magneto receptive species should be conducted before and after cables are operational, and compared to species distributions in control areas. The proposed studies should also address whether there are differences in life history stages and population sizes at the community level. Analyses should include Population Viability, Demographics, Individual Based and GIS Modeling. Studies should also consider trophic relationships and the long term effects on magnetosensitive microorganisms that are affected, and the potential ecological consequences.

Magnetosensory Biology

The mechanisms by which magnetic fields are detected are poorly understood, limiting the ability to develop suitable mitigation measures. Although behavioral studies show that several marine taxa respond behaviorally to magnetic stimulation, a putative magnetoreceptor is described incompletely for only a single aquatic species, the rainbow trout *Oncorhynchus mykiss* (Diebel et al. 2000; Walker et al. 2007). Many previous behavioral studies on magneto-sensitive marine organisms have used test stimuli designed to facilitate the experiment, but do not present natural stimuli that the animal may encounter in the wild or from a wind generator cable. Thus, until the magnetoreceptors and their response properties are characterized, it is not possible to identify with confidence the relevant features of magnetic fields (e.g. intensity, inclination, etc.) that may need to be mitigated. For species of concern that are affected by EMFs the receptor system should be evaluated. Some suggested experimental questions are:

Do elasmobranch and marine teleost fish have a magnetite-based sensory organ?

Previous behavior and physiological studies show that elasmobranch fishes respond and can be trained to detect applied magnetic stimuli, but it is yet to be demonstrated whether these stimuli are detected by their electrosense or another magnetite-based sensory system. While the response properties of the electrosense are reasonably understood, definition of the magnetoreceptor system is required to sort direct magnetic from induced electric effects.

Most marine bony fish are not electroreceptive and a putative magnetoreceptor system in the olfactory organ and neural pathways is known only for the freshwater rainbow trout. No homologous or alternative marine fish magnetoreceptor is yet described. Thus, it is critical to confirm whether marine fish possess a magnetoreceptor system. Lack of a magnetoreceptor system would indicate that based upon best available knowledge, EMFs from cables are not sensed directly by marine fish. Confirmation of a homologous magnetoreceptor system in relevant marine fish species would allow focus on magnetic field mitigation solutions.

Applied anatomical research should investigate olfactory organ tissues of marine elasmobranch and bony fish species for an embedded magnetosensory organ. The olfactory epithelium of candidate species can be screened for magnetite crystals in specific organ layers using combinations of confocal and TEM microscopy as described by Walker et al. (1997), and possibly magnetic imaging. Minimally, confirmation of a putative magnetoreceptor organ that is similar in content and location as reported for the rainbow trout would strengthen justification for magnetic field mitigation. Among teleosts, it would be logical to focus initial efforts on species most closely related to the rainbow trout, members of the salmonid family.

Do fish that possess a putative magnetoreceptor organ respond to controlled magnetic stimuli?

Once a putative magnetoreceptor and associated neural system is confirmed by anatomical study, the response properties to controlled magnetic stimuli can be identified at the level of the cell and the whole organism. Physiological studies of receptor and nerve stimulation in the laboratory can provide important confirmation of magnetoreceptor thresholds, stimulus response properties of the nervous system and relevant features of applied magnetic stimuli. These can be confirmed in the whole animal by controlled laboratory experiments on focal species following many techniques used on other fish species that are described in this report. These studies are required to confirm functionality of the putative magnetoreceptor system.

Natural History

The action of EMFs from wind generator facilities on marine organisms depends on their spatial overlap, age-dependent distributions, reproductive biology, food habits and other life history characteristics. However, the basic natural history for many potentially affected marine species is poorly known. The best studied species have high conservation status or are of interest to commercial or sport fisheries. Many additional species conduct long-distance annual migrations along coastal waters to feeding, mating or nursery grounds. The available and deficient natural history information on priority invertebrate and vertebrate species may be addressed in the permitting process (generally by the project developer) or through independent research efforts. These efforts should address the following questions:

Where will wind generation systems be constructed and what marine organisms are most likely to encounter them?

The specific geographic locations, habitats and sub-habitats at which wind generation facilities and cable tracks to inshore areas may be constructed need to be identified. Site and regional surveys using standard pelagic and benthic sampling techniques can be conducted over annual periods, or existing data can be used if available. These studies should identify marine species and abundances that are likely to encounter wind generation facilities and transmission cables. These will be of value to future monitoring of established facilities.

What marine organisms are most likely to be impacted by EMF facilities?

Based upon current and future knowledge of electro- or magnetosensitivity, marine species that may be impacted by anthropogenic electromagnetic sources associated with wind farm

operations can be identified. This assessment can also be used to direct both the *Response to and Consequences of Cable EMFs* and *Magnetosensory Biology* priorities discussed above.

What are the long-term effects of EMFs from undersea cables associated with offshore renewable energy projects on marine organisms and populations?

There should be continued post-construction field surveys of marine species abundances and distributions in wind generator facility and transmission cable sites for comparison with control sites in similar habitats. This effort is distinguished from long-term effects addressed in *Response to and Consequences of Cable EMFs* in that these will document any changes in marine communities and would be useful for any unanticipated future mitigation efforts.

4.3.2.3 Specific Research Opportunities

AC and DC cables in US waters identified in this study (Appendix Tables B-1 and B-13) may provide opportunities for field testing some of the priority species or closely-related taxa (e.g., elasmobranchs, sturgeon, possibly crustaceans). Relevant information on responses of other species to EMFs may be developed sufficiently for NEPA analysis through laboratory investigations (e.g., sea turtle hatchlings, crustaceans). Still other taxa may be evaluated through statistical techniques (e.g., marine mammals).

Priority Mesocosm Studies

Mesocosm studies need to account for the size (so that the enclosures can be appropriately scaled) and geographic range of the species to be tested (so that an appropriate cable is selected). This type of study is most readily used for benthic or demersal species. Enclosures should be placed both over operational cables and an appropriate control site located outside the predicted magnetic field of that cable. Operational data on the cable should be obtained and *in situ* measurements of field strength should be taken. Substrate conditions should be similar at the experimental and control sites. This can be documented using such techniques as sidescan sonar, videography, sediment profile imagery, or standard benthic grab sampling. Individuals in both the experimental and control enclosures should be tracked using ultrasonic tags so that patterns of movement can be discerned. Video footage of activity at the cable should be recorded to study behavior.

Sandbar shark is the preferred elasmobranch species for initial testing but a closely-related carcharhinid shark from the Pacific may be an appropriate surrogate. Preferably, testing would be done using juvenile sharks in order to obtain the most relevant information for assessing impacts in the sandbar shark HAPC. Potential cables suitable for a mesocosm study include AC cables associated with oil platforms in the Pacific and the Norwalk CT to Northport NY AC cable in Long Island Sound. Voltage along each of these cables is about the same as would be expected along interconnecting cables within a wind project.

AC Cables that might be suitable for testing sturgeon include the San Juan Cable in Puget Sound (69 kV) and the Norwalk CT to Northport NY cable in Long Island Sound (138 kV). Because the voltage of the San Juan cable is low compared to interconnecting cables in wind projects, the Long Island Sound cable may be more appropriate for testing. As the Atlantic sturgeon is known

to occur in Long Island Sound, it could be used as a surrogate for its congener from the Pacific, the green sturgeon. Compared to other sturgeon species, both the green and the Atlantic sturgeon spend much of their life in marine waters; it is reasonable to assume, therefore, that experimental results would be transferable between the two species.

Arthropods should be tested near DC cables. In the Atlantic, suitable cables would include the Cross Sound Cable (150 kV) in Long Island Sound and the Neptune Regional Transmission System (500 kV) in the New York Bight for testing American lobsters or horseshoe crabs. In the Pacific, the Trans Bay Cable in San Francisco Bay may be suitable for testing spiny lobster and Dungeness crabs. In each case, it would be important to ensure that the general substrate conditions meet the species' habitat requirements. For the lobsters in particular, refugia should be available within the enclosures. This type of study could be useful in determining whether nocturnal feeding excursions and homing to individual burrows are disrupted. The relatively small size of these species in addition to the very limited understanding of the sensitivities of most to electric or magnetic fields, however, suggest that preliminary laboratory studies may be a useful initial approach.

Priority Laboratory Studies

Ability of American lobsters, Dungeness crabs, or horseshoe crabs to sense electric or magnetic fields has not been determined so conducting field studies with these species may be premature. Instead, these species could be exposed to fields of a similar intensity to those predicted for interconnecting and export cables for offshore wind projects in the laboratory where it is easier to control other variables and make direct observations. If exposure to these fields elicits no or limited responses, then no further testing would be necessary.

Sea turtle hatchlings are potentially at risk from exposure to DC cables that are oriented in such a way that they alter the geomagnetic field. At the present, there are no DC cables in known sea turtle nesting areas nor are there any DC cables proposed in these areas. With the expressed interest in offshore wind development in the Gulf of Mexico and the southeastern states, however, it would be prudent to examine this risk in advance of any project development. Studies on the geomagnetic sense of loggerhead turtle hatchlings conducted by Lohmann et al. (2008c) provide a reasonable laboratory setup for exposing hatchlings to DC magnetic fields of the intensity anticipated from offshore wind project export cables.

Statistical Studies

Review of evidence on magnetic sense in marine mammals in the context of the likely behavior and risk of exposure of these species to magnetic fields from DC cables suggests that the potential for impacts are relatively low. Given this and the challenges of conducting field studies with large mobile species, it is suggested that experimentation with marine mammals not be prioritized. A desktop study updating the studies correlating live strandings with geomagnetic minima conducted by Kirschvink et al. (1986) and Kirschvink (1990) and analyzing the results in the context of proximity to DC cables would provide an indication of whether this type of risk exists. If there is a correlation between live strandings and DC cables, then magnetic field

strength for each cable should be modeled so that information could be used as a basis for future decisions on cable design features such as separation, orientation and burial depth.

4.4 MITIGATION

It has not been determined that there are adverse impacts associated with exposure to EMFs from undersea cables of a level that would affect populations or ecosystems, although it is a reasonable question whether a large number of cables, particularly within a small geographic area, might have some effect on species within the habitat. It is, therefore, appropriate to consider means by which exposure to EMFs can be minimized or avoided.

4.4.1 Engineering Solutions to Reduce EMF

There are a variety of aspects of the design and installation of submarine cables that affect magnetic field levels in the cable vicinity. These aspects include current flow, cable configuration, conductivity and permeability of sheathing and armoring materials, the cable's orientation in the geomagnetic field (DC cables only), and distance from cables (including burial depth). To date, choices regarding these aspects of design and installation have been dictated almost entirely by project specific factors and costs, not an intentioned desire to minimize magnetic fields. The role of these factors is summarized briefly below:

Current flow. Since the magnetic field varies directly with current flow on a cable, the greater the power flow, the greater the magnetic field and vice versa. To transmit the same amount of power a lower current flow is needed at higher voltage as determined by $\text{Power} = \text{Voltage} \times \text{Current}$. Thus, higher voltage cable systems produce lower magnetic fields than lower voltage cable systems for the same power delivered.

Cable configuration. Greater mutual cancellation of the magnetic fields from cables is achieved by placing the cables close together because of the vector nature of magnetic fields. Placing the cables close together not only reduces the peak magnetic field but it increases the rate at which the field diminishes with distance from the cables. Bundled AC three-phase cables therefore will produce lower magnetic fields that will diminish more quickly with distance than single-phase cables carrying similar loads. Sometimes, submarine cables are extended by horizontal directional drilling from shore in conduits to minimize disturbances in shallow waters before emerging as separate cables. DC cable configurations that place cables closer together and with equal current will have the lowest magnetic fields as is illustrated in Figure 4.4-1. In the extreme, a coaxial configuration in which a DC power cable is contained wholly inside the return conductor will totally contain the magnetic field. In those situations where separate circuits, i.e., cables from separate sources, are placed close together, the physical arrangement of the cables can be planned so that the magnetic fields from each circuit optimally cancel the magnetic fields from adjacent circuits, termed 'optimal phasing.' This is most practical for circuits on land where the cables are located in duct banks and the orientation of cables is easily maintained rather than undersea. Submarine cables installed as separate cables for power transfer across water bodies typically are not placed close to one another in order to prevent a single localized event from incapacitating multiple circuits.

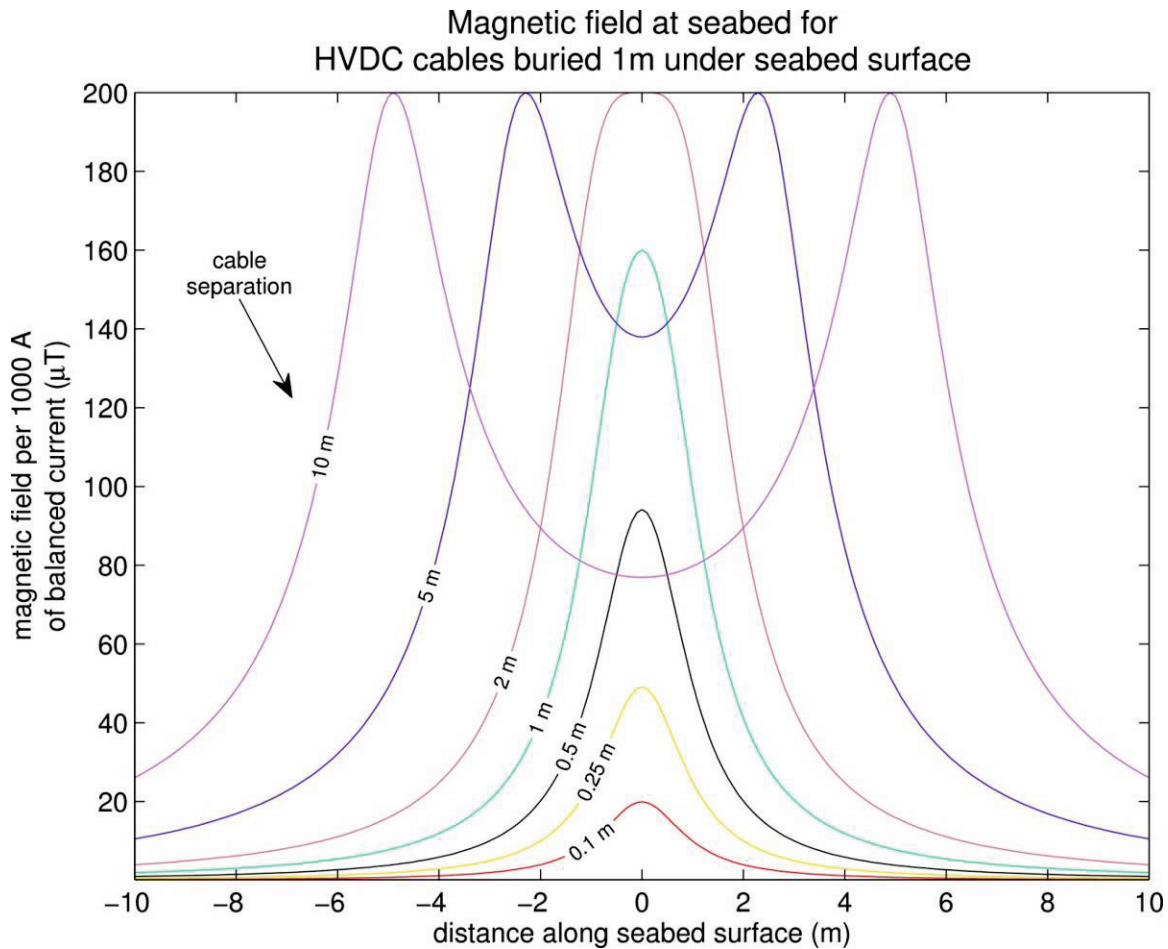

Figure 4.4-1. Magnetic field profiles at the seabed surface for a DC cable buried 1 m below the seabed. Vertical axis shows the magnetic field per 1000 Amperes of balanced current (in either a bipolar or monopolar with return cable system).

While AC cables are most often installed together, DC cables may be installed at some distance from each other. Figure 4.4-1 shows how the distance between the two DC cables affects the intensity and spatial distribution of the DC magnetic field. Appendix Tables B-7 and B-8 allow one to estimate the magnetic field at distances to 50 m above the cables and 100 m along the seabed for any power flow for cable separations of 0.5 m and 1 mm, respectively.

Electric fields from energized AC cable conductors are shielded effectively by metallic sheathing and armoring. Cables without such grounded metallic covering could be sources of electric fields but no such cables were identified among the projects surveyed. In monopolar operation DC systems that return current through sea water between electrodes are sources of unshielded electric fields that are strongest close to the sea electrodes.

Conductivity and magnetic permeability of cable sheaths/armoring. Increasing the conductivity and permeability of metallic sheaths and armoring covering the cables will reduce the magnetic field. AC cables with shielding provided by metallic sheaths and armoring will produce lower

magnetic fields outside the cable than will unshielded cables. Unlike shielded cables, unshielded cables will also produce electric fields in the surrounding marine environment. The UK requires that power cables be armored (DECC 2010).

Cable orientation. The magnetic field from DC cables interacts with the earth's geomagnetic field, which causes the total resulting field (cable field + geomagnetic field) to vary with the orientation of the cable. During project planning, the most direct route is usually considered to be the most desirable because it equates to the lowest costs, however, the orientation of the geomagnetic field should be considered as a means to reduce magnetic fields.

Distance from cables. As for all sources, the field strength (and potential exposure by organisms) has an inverse relationship with distance from the cables. For submarine cables one factor that affects the maximum potential exposure of marine organisms is the burial depth of the cables. The effect of burial depth on magnetic field strength in the overlying water can be appreciated from Figure 4.4-2. That figure compares the magnetic field at the surface of the seabed above cables buried 0.5m, 1m, 1.5m, and 2 m. Appendix Tables B-9 through B-12 allow one to estimate the magnetic field from an AC submarine cable for any power flow at burial depths of 0.5, 1.0, 1.5 and 2.0 m. For offshore wind projects in the UK, DECC (2010) requires that the cables be buried at least 1.5 m below the seabed. In some cases, the substrate conditions might not lend themselves to burial under the natural sediments. An alternative is to place the cable directly on the seafloor or in a shallow trench and place rock or concrete mattresses over the cable, simultaneously protecting the cable and adding an additional barrier that would reduce the EMF levels in the water column.

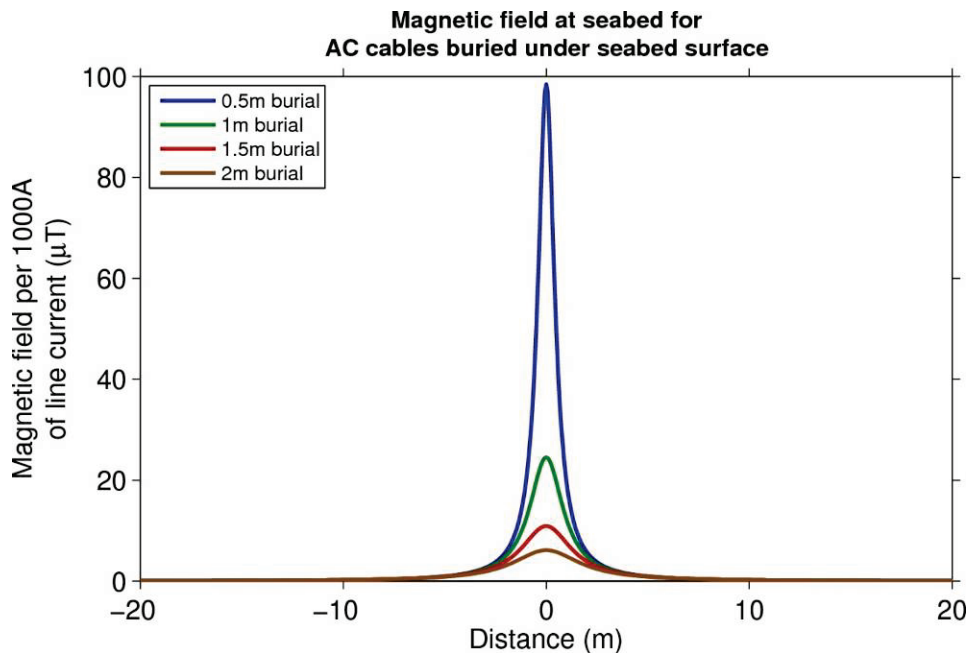

Figure 4.4-2. Magnetic field profiles at seabed level for an AC cable buried 0.5 m, 1 m, 1.5 m, or 2 m. Vertical axis shows the magnetic field per 1000 Amperes of line current in the buried 3-phase cables.

If there are environmental reasons to minimize magnetic fields from submarine cables the above factors suggest some strategies to accomplish this goal. Table 4.4-1 lists five different strategies that will reduce magnetic fields from undersea cables and an approximate ranking as to the potential effectiveness based on the effect each could have on modeling results.

Table 4.4-1.

Effectiveness of Potential Magnetic Field Reduction Strategies.

Design Factor	Relative Effectiveness
Cable Design	High
Cable Voltage	High
Burial Depth	Moderate
Concrete Mattress	Moderate
Additional Cable Sheathing	Low

The most practical and effective strategies would involve the design of the cable system, including increasing the operating voltage, placing the cables as close together as possible, and increasing the burial depth of the cables beneath the seabed. If the desired burial depth could not be achieved at limited locations, then covering the cable with rocks or concrete mattresses could be an option. Environmental benefits versus associated costs must be determined when considering such options. Increasing the conductivity and permeability of the metallic sheaths and armoring of the cable are also options, but rarely are these parameters known in advance of the receipt of bids from cable suppliers, which occurs after project permitting. In most circumstances, changing the orientation of the cables with respect to the earth's dipole magnetic field would not be a practical option. While there has been discussion in the literature as to such mitigation options, there is no documentation that any of these methods have been intentionally and solely exploited to minimize exposure of marine animals to magnetic or electric fields from submarine cable systems. The effectiveness of mitigation measures can be readily determined by modeling the magnetic fields for the proposed design and operating conditions and then varying the design factors. Before recommending any potential magnetic field reduction strategy, however, potential environmental effects of the design measure should be carefully evaluated (see Section 4.4.2). For examples, deeper burial depths, addition of concrete mattresses over the cable, and extra metallic sheathing may lead to higher than expected heating which might then require larger cables, distribution of load onto additional cables, and wider spacing of cables to permit heat dissipation.

4.4.2 Marine Species

Most opportunity to mitigate adverse effects of exposure to EMFs from offshore renewable energy projects comes from the engineering methods discussed in Section 4.4.1. This section discusses potential secondary effects of these engineering solutions. Secondary effects, or impacts, are those that would arise as a result of implementing a mitigation measure. The determination of whether these secondary impacts are acceptable (i.e., are less harmful to the environment than the stressor the mitigation is designed to reduce) would have to be determined

on a project-by-project basis. This section also proposes steps that can be taken during project planning that could also reduce the risk of exposure.

4.4.2.1 Secondary Effects of Engineering Solutions

Two of the engineering solutions would potentially reduce the likelihood of impacting marine organisms. Increased operating voltage would appear to have few, if any, consequences to the marine environment as long as the impermeability of the armoring/sheathing and the burial depth were appropriate. The type of sheathing would be unlikely to affect marine resources because epibenthic and water column species would not be exposed to the sheathing. A burial depth of 1.5 m or greater would keep the cable below the most active biological layer so benthic infauna would have little risk of being exposed to the sheathing either.

Three of the engineering solutions (distance between cables, deeper burial, and changing the orientation of DC cables) would affect the amount of substrate disturbed during installation. The effects would generally be considered temporary. The assumption is typically made that the seabed would recover either to the pre-installation grain size and bathymetric conditions (through intervention or by natural processes) or to a condition indistinguishable from the adjacent seafloor (in the event of regional phenomena such as major storms). Placing cables as close together as possible has mixed effects – if all cabling can be placed in one trench, the footprint and duration of the impact would be lessened. Less material would be released into the water column. If cabling cannot be placed in one trench, the distance between the trenches would not affect the level of impacts to the seafloor or water column.

Deeper burial would not eliminate the EMF, only reduce its maximum emission, and also increase substrate disturbance, releasing a larger quantity of sediment into the water column, with potential down current sedimentation effects. It could require multiple passes of the jet-plow in order to achieve the desired depth, increasing the duration of the disturbance. Some organisms are attracted to this type of disturbance because it provides feeding opportunities as a result of displacement of benthic organisms. Other species might be repelled by the activity. Ultimately, it is likely that the substrate would return to a condition similar to the preinstallation texture and bathymetry, or to a condition similar to nearby undisturbed areas if there are widespread natural phenomena (e.g., major storms) that affect the seafloor during the recovery period.

Changing the orientation of DC cables would likely result in a longer cable route, resulting in higher costs, longer duration of installation, a larger footprint of disturbance, and a longer distance over which EMFs could be emitted. It could be a suitable solution in areas where particularly sensitive species are known or likely to occur, for example, turtle nesting beaches, nearshore shark nursery areas, or near the mouths of bays or rivers known to support salmonids.

Covering the cable with rock or concrete mattresses would be considered habitat alteration. Where habitat diversity is low, such as off the Mid-Atlantic states, this could be viewed as a benefit, particularly if it provides three-dimensional structure and acts as an artificial reef.

4.4.2.2 Other Types of Mitigation

Knowledge of the distribution of key species and their habitat use locally can aid substantially in minimizing impacts during the planning stages. Siting is a key phase during project development. There are two groups of species in particular for which nearshore waters provide important habitat: sea turtles and coastal sharks. Turtle nesting beaches are well-documented and use of the nearshore area is important during several life stages. Effects of exposure to undersea cables on migrations are not understood conclusively, however. Given the status of these populations, avoiding placement of new power cables in the vicinity of nesting beaches would prevent such an impact.

NMFS has identified several areas in the Mid-Atlantic as providing important nursery and pupping grounds for the sandbar shark and designated them as Habitat Areas of Particular Concern (HAPC). These areas include “shallow areas and at the mouth of Great Bay, New Jersey, in lower and middle Delaware Bay, Delaware, lower Chesapeake Bay, Maryland, and near the Outer Banks, north Carolina, and in areas of Pamlico Sound and adjacent to Hatteras and Ocracoke Islands, North Carolina, and offshore of those islands” (NMFS 2010b). As was described in Section 4.3.2, the potential effects of EMF exposure on early lifestages of sharks are largely unknown, but considering the implications to the population if added stressors are placed on pups and juveniles, it would be wise to err on the side of caution until more information is known. Even though most of the HAPC is located within estuarine waters and export cables for offshore wind projects are not likely to cross into estuarine waters, identifying suitable landfalls as far from the boundaries of the HAPC as is reasonable would help to minimize any risk to the species.

4.4.3 Monitoring of Mitigation Measures

As described in Section 4.3.1, a first step for monitoring the effect of engineering solutions would be to collect field measurements of electric and magnetic fields around operating cables and obtain reference measurements to account for any background emissions not associated with the cables. It would be important to have accurate information on how much power was passing through the cable at the time of field collections. Results would be compared to modeling that uses the design characteristics of the cable with and without the mitigative features. Similarity of field measurements to the model using the mitigative characteristics would indicate that engineered mitigation was working as planned.

Biological monitoring of EMF mitigation measures would likely be most successful if it was done at the species level rather than the community level and at the individual level rather than the population level, given the status of knowledge of EMF effects. It will be important to define the research hypotheses carefully so that data are analyzed using appropriate statistical tests and interpretations are definitive. While it is important to understand what organisms use the project area prior to the installation of a cable, it is rare that there is sufficient baseline data to document whether a post-installation data point falls within or outside the natural variability of a particular species; the usefulness of the BACI (before-after, control-impact) approach is limited in this respect. Biological monitoring should focus on observing the behavior of the selected species in the presence (and absence, as a control) of the powered cable. Selection of the species to be studied would be project-specific, dependent on the species of concern locally. If the hypothesis

addresses simply whether a particular species is affected by the presence of the cable, it wouldn't matter if the electro- or magneto-sensitivity of the test species is known. In that case, care must be taken to make sure that the condition of the seabed following cable installation does not influence interpretation of the results as was possibly the case with monitoring at Nysted (DONG 2006). If the hypothesis focuses on whether the mitigating factor is preventing a response to an electric or magnetic field, then the test species must be selected accordingly.

One potential approach to determining whether fish are passing over the cable freely would be to monitor the cable area and a comparable control area acoustically (for example, with ultra-sonic tags) to determine patterns of movement. These measurements could be supplemented with species-appropriate sampling gear to confirm numbers of fish that crossed or did not cross the cable. Requirements for monitoring of EMF effects during operation should also provide for possible remediation actions if adverse effects beyond those identified in the NEPA analysis (and accepted during permitting review) are found. As with any required mitigation, therefore, it will be important to determine success criteria at the time the mitigation plan is developed.

4.5 POTENTIAL CUMULATIVE EFFECTS OF EMFs ON MARINE SPECIES

Cumulative effects must be considered for NEPA reviews and are generally defined as "the aggregate of past, present, and reasonably foreseeable future actions." As stated in 40 CFR 1508.7, "The impact on the environment which results from the incremental impact of the action when added to other past, present, and reasonably foreseeable future actions regardless of what agency (Federal or non-Federal) or person undertakes such other actions. Cumulative impacts can result from individually minor but collectively significant actions taking place over a period of time."

Evaluation of cumulative impacts typically considers the entire range of stressors to which organisms might be exposed, caused both by the project itself and by other actions. The primary goal for consideration of cumulative effects of EMFs on marine species in this project was the evaluation of exposure to more than one power cable. This evaluation must be placed in the context of the behavior and habitat use of individual species. For species of limited mobility, the area of concern could be limited to a particular offshore wind project array. These species may experience repeated (or even continuous) exposure from the same source. For highly motile species, such as marine mammals and sharks, the area of concern would include the species' entire migratory route. Migratory species, therefore, may have the potential to be exposed to a greater number of power cables, although exposure to each cable may be limited. Either situation has the potential to affect species at the individual level which is fundamental to population processes. Impacts to migratory populations could affect the species as a whole if stressors occur over much of its range whereas populations of stationary, but widely distributed, species would be affected locally.

Most offshore renewable energy projects and their associated cables are likely to be installed proximal to areas of human population density. Presently, proposals for offshore wind projects are fairly concentrated in a few locations with the major focus along the Atlantic coast from the North Carolina-Virginia border to the Gulf of Maine, although that could change. Specific projects have been proposed for Massachusetts, Rhode Island, southern New Jersey, and

Delaware. BOEMRE has issued Requests for Interest for Maryland and other portions of the Massachusetts coast and all Atlantic states from Florida to Maine have developed task forces to examine the possibility of developing the offshore wind resource commercially. This concentration of projects could mean the installation of a number of separate export cables (either AC or DC), as well as miles of within-array cables (most likely AC cables), within a relatively short distance (tens of miles) along the coast. The Atlantic Wind Connection project has recently been proposed to provide a transmission “backbone” between Virginia and New York.

Along the contiguous US coast, resources in the nearshore environment have been subject to numerous environmental stresses for decades, including habitat disturbance and alteration (e.g., dredging, mining, coastal development), water quality degradation (e.g., municipal discharges, although with areas of improvement in recent decades), intense fishing activities, and shipping activity, among others. Development of offshore wind energy projects will add there are other impact-producing factors including EMFs from power cables. Among the long-term factors not addressed in this report are vibrations from the turbines that affect the underwater noise environment, stray electrochemical or electromotive fields, and the introduction of artificial habitats. Various marine organisms rely on sound at different frequencies for communication and these anthropogenic noises have the potential to attract, repel, or disrupt communications in many species. Metals and paints used in underwater support structures may produce weak electrochemical fields that can be detected and investigated by free swimming sharks and rays. Stray electric fields intentionally introduced into the environment such as those used for cathodic protection of platforms or load balancing of power transmission would also present additional relevant electric stimuli to the environment. Such stimuli may modify the behavior of elasmobranchs in the immediate vicinity of underwater structures or transmission nodes. Finally, underwater structures, pilings or rigs will attract many species of fishes that use these structures for refuge. Individual projects will need to consider the existing conditions at their proposed site in order to place the added effects of exposure to EMFs in the proper context.

Given that an organism can respond to EMF, when moving within a wind farm array it may encounter multiple different EMFs and may respond to each field in turn. Whether this cumulative encounter will have an effect will only be known if a biologically relevant effect occurs on each encounter, such as expending time and energy responding to an EMF field and not obtaining food. If this were to occur a sufficient number of times then the organism could be affected through reduced survival or lower reproductive opportunity and rate, which would then be translated to population effects. Sufficient targeted research has not yet been done that allows this level of interpretation and prediction of effects.

At the current state of knowledge, and with having no specific projects to examine, conducting an assessment of cumulative impacts from multiple EMF-producing sources can only be speculative. Rather, this report suggests guidelines for what such an assessment should consider. Marine organisms can be roughly divided into three behavioral groups relevant to this issue: coastal migrants, onshore-offshore migrants, and resident species or lifestages. Regardless of the phylogenetic affiliation, the assessment of cumulative impacts for all species within each behavioral group can be approached the same way.

Coastal migrants. Several groups of species, including marine mammals, sharks, and some other fish species, perform north-south migrations annually. This behavior has the potential to expose large portions of their populations to multiple intra-array and export power cables over the course of each migration. To evaluate cumulative effects, one needs to understand several things: sensitivity threshold; response at the threshold; likely location of the individuals in the water column; probable habitat use at each cable location; and potential duration of exposure. Species that remain close to the seafloor during much of the migration would clearly have greater exposure than species that swim relatively high in the water column. Species that stop frequently and feed demersally, or dive to feed, during the migration have a greater potential for exposure than those that swim for long distances without feeding or that feed pelagically. Modeling of the field gradients (Section 4.1), however, indicates that the spatial extent of these fields is limited horizontally to perhaps tens of meters; the portion of the water column affected is a function of water depth so that fields may extend throughout the entire water column at detectable levels for some species near the shoreline. Potential risks from multiple exposures could include multiple navigational miscues, if these are not corrected by the use of other senses, or interference with feeding. Either of these effects could place higher energy demands on individuals.

Onshore-offshore migrants. These species can be further divided into two subgroups, those in which individuals undertake annual migrations and those in which the onshore-offshore migration relates to reproduction. Species like lobsters, Dungeness crabs, and horseshoe crab tend to have annual onshore-offshore migrations. This behavior could cause individuals to be exposed to the same cable (or perhaps, more than one cable) multiple times over their lifetimes. The orientation of the cable to their migratory route and the location of the offshore migratory endpoint would determine the actual duration of their exposure. There is presently no evidence suggesting whether infrequent, repeated exposure would have a cumulative effect on such species.

In some species, including anadromous fish, catadromous fish, and sea turtles, onshore/offshore movements are related to reproductive activities. Anadromous fish (e.g., salmonids) migrate from the sea into estuaries and rivers to spawn in the spring and young-of-the-year move down the estuary back to the sea in the fall; catadromous fish (e.g., eels) make the opposite migration. Sea turtles lay eggs on ocean beaches and hatchlings leave the nests several months later to swim offshore. For the anadromous or catadromous species, individuals have the potential of two (salmon) or more (river herring) exposures to a particular cable over the course of a life time. While in the ocean most of these species tend to be pelagic, a behavior that would limit any exposure to EMFs emitted from power cables. Sea turtles are long-lived and may reproduce many times, so individuals could be exposed multiple times. Existing evidence (see Section 4.2.4) suggests that nearshore navigation is governed by multiple cues, so exposure to an altered magnetic field near the nesting beach may not affect their ability to reach the beach. Hatchlings are unlikely to encounter more than one export cable, so cumulative effects would be unlikely.

Resident species or lifestages. Species in this behavioral group include sessile or weakly motile taxa (benthic infauna or attached invertebrates) and taxa for which different life stages occupy different habitats (e.g., sandbar shark for which nursery/juvenile habitat is distinct from adult habitat). Individuals of sessile or weakly motile species could experience repeated or continuous

exposure from the same cable. The effects from this type of exposure would be addressed in the direct impact analysis, rather than the cumulative analysis, unless more than one cable crossed the defined habitat, exposing a greater proportion of the population than a single cable would. Even so, a cumulative impact would only be accrued if exposure to EMFs from the projects together degraded the habitat to an extent that it threatened the ability of the species to continue to reside there.

Juvenile sandbar sharks occupy fairly well-defined areas along the Atlantic coast and they remain in this habitat for up to a couple of years. They could be sensitive to magnetic fields (although the mechanism is unproven at this point) and induced electric fields from power cable EMFs. As described in Section 4.2.2, some studies have reported behavioral changes in the presence of EMFs. The significance of these responses is unknown, but these results suggest a potential for causing higher energy demands on individuals by diverting their ability to seek prey successfully. If this juvenile habitat is crossed by multiple cables, a larger proportion of the population could be affected and result in an incremental (although, perhaps not measureable) reduction in the population viability.

Given the difficulty in understanding the ability of many marine species to sense or the likelihood of their responding to EMFs from undersea power cables, quantifying the significance of this exposure can only be done cautiously and few generalizations can be made. Coastal migrants are more likely to cross cables than onshore-offshore migrants. Further extrapolation to the effects of exposure to multiple EMF sources can only be speculative.

5. CONCLUSIONS

This synthesis of available data and information clearly demonstrates that more work is needed to understand the nature and magnitude of any potential impacts to marine species from undersea power cable EMFs. Nonetheless, EMF modeling results in this report provide a general reference for understanding the magnitude and characteristics of magnetic and induced electric fields from undersea cables. The listing of priority species for US waters provides a focused list of species for which evidence suggests magneto- or electrosensory capabilities. The analyses of potential impacts and compilation of data gaps and research priorities provide direction to guide further efforts to address the question of effects from power cable EMFs on marine species.

Conclusions that can be drawn from the information gathered in this report include:

- Anticipated EMFs from power cables can be modeled easily as long as specific information is available:
 - Cable design
 - Burial depth and layout
 - Magnetic permeability of the sheathing
 - Loading (amperes)
- Modeling of DC cables must take local geomagnetic field into account to accurately predict field strength
- Voltages of interconnection cables are lower than on export cables resulting in lower magnetic fields than from within-array cabling
- Species with electrosensitivity are likely to be able to detect EMFs from both DC and AC cables with high sensitivity to DC cables. Taxa include:
 - Elasmobranchs
 - Some teleost fish
 - Some decapod crustaceans
- Species with magnetosensitivity are more likely to be able to detect EMFs from DC cables than from AC cables. Taxa include:
 - Sea turtles
 - Some marine mammals
 - Some decapod crustaceans
- Electrosense is well documented among elasmobranchs so knowledge about the effects of exposure to EMFs on one species can be cautiously applied to another species with similar physiology and behavioral patterns (e.g., preferred position in the water column, prey items, habitat preferences)
- Behavioral responses to electro- or magnetic fields are known for some species but extrapolation to impacts resulting from exposure to undersea power cables is speculative.
- Demersal species (some elasmobranchs, other fish species, or decapod crustaceans) are more likely to be exposed to higher field strengths than pelagic species.
- Despite the fact that the available biological information allows only a preliminary level of impact assessment, modeling indicates that the electromagnetic fields emitted by undersea power cables are limited spatially (both vertically and horizontally). This

spatial limitation must be considered in any impact assessment as it reduces the risk that any given organism will be exposed.

6. REFERENCES

- Able, K. P. 1991. Common themes and variations in animal orientation systems. *American zoologist* 31:157-167.
- Adair, R. K. 1994. Constraints of thermal noise on the effects of weak 60-Hz magnetic fields acting on biological magnetite. *Proceedings of the National Academy of Sciences of the United States of America* 91:2925-2929.
- Akoev, G.N., O.B. Ilyinsky, and P.M. Zadan. 1976. Responses of electroreceptors (ampullae of Lorenzini) of skates to electric and magnetic fields. *Journal of Comparative Physiology A* 106(2): 127-136.
- Akoev, G. N. and V. M. Muraveiko. 1984. Physiological-properties of lateral line receptors of the lamprey. *Neuroscience Letters* 49:171-173.
- Alerstam, T. 2003. Animal behaviour - The lobster navigators. *Nature* 421:27-28.
- Alerstam, T., A. Hedenstrom, and S. Akesson. 2003. Long-distance migration: evolution and determinants. *Oikos* 103:247-260.
- Allen, B.M. and R.P. Angliss. 2010. Alaska Marine Mammals Stock Assessment, 2009. NMFS-ASFC-206 U.S. Dept. Commerce. NOAA NMFS-AFSC. 276 pp.
- Andrianov, G.N., H.R. Brown, and O.B. Ilyinsky. 1974. Responses of central neurons to electrical and magnetic stimuli of the ampullae of Lorenzini in the Black Sea skate. *Journal of Comparative Physiology* 93: 287-299.
- Andrianov, Y. N., G. R. Broun, O. B. Ilinskii, and V. M. Muraveiko. 1984. Frequency-characteristics of skate electroreceptive central neurons responding to electrical and magnetic stimulation. *Neurophysiology* 16:364-369.
- Andrulewicz, E. D., D. Napierska, and Z. Otremba. 2003. The environmental effects of the installation and functioning of the submarine SwePol Link HVDC transmission line: a case study of the Polish marine area of the Baltic Sea. *Journal of Sea Research* 49:337-345.
- ASMFC (Atlantic States Marine Fisheries Commission). 2010. [Http://www.asmfsc.org/](http://www.asmfsc.org/) accessed April 2010.
- Asplund, G., L. Carlsson, and O. Tollerz. 2003. 50 Years HVDC Part I. ABB – from pioneer to world leader. *ABB Review* 4/03: 6-8.
- ASSRT (Atlantic Sturgeon Status Review Team). 2007. Status Review of Atlantic Sturgeon (*Acipenser oxyrinchus oxyrinchus*). Report to National Marine Fisheries Service, northeast Regional Office. 174 pp.
- Avens, L., J. Braun-McNeill, S. Epperly, and K.J. Lohmann. 2003. Site fidelity and homing behavior in juvenile loggerhead sea turtles (*Caretta caretta*). *Marine Biology* 143: 211-220.

- Avens, L. and K. J. Lohmann. 2003. Use of multiple orientation cues by juvenile loggerhead sea turtles *Caretta caretta*. *Journal of Experimental Biology* 206:4317-4325.
- Avens, L. and K. J. Lohmann. 2004. Navigation and seasonal migratory orientation in juvenile sea turtles. *Journal of Experimental Biology* 207:1771-1778.
- Baltic Cable, A. B. 2010. Welcome to Baltic Cable. Internet website: www.balticcable.com. Accessed: April, 2010.
- Basov, B. M. 1999. Behavior of Sterlet *Acipenser ruthenus* and Russian Sturgeon *A. gueldenstaedtii* in Low-Frequency Electric Fields. *Journal of Ichthyology* 39:782-787.
- Basov, B. M. 2007. On the electric fields of the electric mains and their perception by freshwater fishes. *Voprosy ikhtiologii* 47:694-699.
- Bauer, G.B., M. Fuller, A. Perry, J.R. Dunn, J. Zoeger. 1985 Magnetoreception and biomineralization of magnetite in cetaceans *In* *Magnetic Biomineralization and Magnetoreception in Living Organisms* (J.L. Kirschvink, D.S. Jones, and B.J. MacFadden, eds.). Plenum Press. New York, NY. 487-507 pp.
- Baumgartner, M. and F. Wenzel, 2005. Observation of near-bottom foraging by right whales in the Great South Channel. Presentation at the Right Whale Consortium Meeting November 2005, New Bedford Whaling Museum, New Bedford, MA.
- Bedore, C. and S. M. Kajiura. 2009. Electrosensitivity and Pore Distribution in the Cownose Ray (*Rhinoptera bonasus*). Poster presented at the 2009 Joint Meeting of Ichthyologists and Herpetologists - Portland, Oregon, 22-27 July 2009.
- Behnke, R. J. 2002. Trout and Salmon of North America. The Free Press, New York, NY.
- Berge, J. A. 1979. Perception of weak electric AC currents by the European eel, *Anguilla anguilla*. *Comparative Biochemistry and Physiology a-Physiology* 62:915-919.
- BERR. 2008. Review of cabling techniques and environmental effects applicable to the offshore wind farm industry. Department for Business Enterprise and Regulatory Reform, UK Government.
- Blonder, B. I. 1985. Prey discrimination and electroreception in the stingray *Dasyatis sabina*. Thesis (M.S.). Florida Institute of Technology, Melbourne, Florida.
- Blonder, B. I. and W. S. Alevizon. 1988. Prey discrimination and electroreception in the stingray *Dasyatis sabina*. *Copeia*: 33-36.
- Bochert, R. and M. L. Zettler. 2004. Long-term exposure of several marine benthic animals to static magnetic fields. *Bioelectromagnetics* 25:498-502.

- Bodznick, D., J. Montgomery, and T. C. Tricas. 2003. Electroreception: extracting behaviorally important signals from noise. Pages 389-403 in S. P. Collin and N. J. Marshall, editors. *Sensory Processing in Aquatic Environments*. Springer-Verlag, New York.
- Bodznick, D. and J. C. Montgomery. 1992. Suppression of ventilatory reafference in the elasmobranch electrosensory system - medullary neuron receptive-fields support a common-mode rejection mechanism. *Journal of Experimental Biology* 171:127-137.
- Bodznick, D., J. C. Montgomery, and D. J. Bradley. 1992. Suppression of common-mode signals within the electrosensory system of the little skate *Raja erinacea*. *Journal of Experimental Biology* 171:107-125.
- Bodznick, D. and R. G. Northcutt. 1981. Electroreception in lampreys - evidence that the earliest vertebrates were electroreceptive. *Science* 212:465-467.
- Bodznick, D. and D. G. Preston. 1983. Physiological characterization of electroreceptors in the lampreys *Ichthyomyzon unicuspis* and *Petromyzon marinus*. *Journal of Comparative Physiology* 152:209-217.
- Boehlert, G. W., G. R. McMurray, and C. E. Tortorici. 2008. Ecological effects of wave energy development in the Pacific Northwest : a scientific workshop, October 11-12, 2007. U.S. Dept. of Commerce, National Oceanic and Atmospheric Administration, National Marine Fisheries Service, Seattle, Wash. 174 pp.
- Boles, L. C. and K. J. Lohmann. 2003. True navigation and magnetic maps in spiny lobsters. *Nature* 421:60-63.
- BPA (Bonneville Power Administration). 1991. Corona and Field Effects Computer Program. Bonneville Power Administration.
- Bratton, B. O. and J. L. Ayers. 1987. Observations on the electric organ discharge of 2 skate species (Chondrichthyes, Rajidae) and its relationship to behavior. *Environmental Biology of Fishes* 20:241-254.
- Brill, R., P. Bushnell, L. Smith, C. Speaks, R. Sundaram, E. Stroud, and J. Wang. 2009. The repulsive and feeding-deterrent effects of electropositive metals on juvenile sandbar sharks (*Carcharhinus plumbeus*). *Fishery Bulletin* 107:298-307.
- Broun, G. R., O. B. Il'inskii, and B. V. Krylov. 1979. Responses of the ampullae of Lorenzini in a uniform electric field. *Neurophysiology* 11:118-124.
- Brown, H. R. and O. B. Ilyinsky. 1978. Ampullae of lorenzini in magnetic-field. *Journal of Comparative Physiology* 126:333-341.
- Brown, H.R., O.B. Ilyinsky, V.M. Muravejko, E.S. Corshkov, and G.A. Fonarec. 1979. Evidence that geomagnetic variations can be detected by Lorenzini ampullae. *Nature* 277: 648-649.

- Bullock, T.H. 1999. The future of research on electroreception and electrocommunication. *Journal of Experimental Biology* 2002: 1455-1458.
- Bullock, T. H. 2005. *Electroreception*. Springer Science Business Media, Inc., [New York].
- Bullock, T. H., S. Karamursel, and M. H. Hofmann. 1993. Interval-specific event-related potentials to omitted stimuli in the electrosensory pathway in elasmobranchs - an elementary form of expectation. *Journal of Comparative Physiology a-Sensory Neural and Behavioral Physiology* 172:501-510.
- Cain, S. D., L. C. Boles, J. H. Wang, and K. J. Lohmann. 2005. Magnetic orientation and navigation in marine turtles, lobsters, and molluscs: Concepts and conundrums. *Integrative and Comparative Biology* 45:539-546.
- Cain, S. D., J. H. Wang, and K. J. Lohmann. 2006. Immunochemical and electrophysiological analyses of magnetically responsive neurons in the mollusc *Tritonia diomedea*. *Journal of Comparative Physiology a-Neuroethology Sensory Neural and Behavioral Physiology* 192:235-245.
- Cameron, I. L., W. E. Hardman, W. D. Winters, S. Zimmerman, and A. M. Zimmerman. 1993. Environmental magnetic-fields - influences on early embryogenesis. *Journal of Cellular Biochemistry* 51:417-425.
- Camperi, M., T. C. Tricas, and B. R. Brown. 2007. From morphology to neural information: The electric sense of the skate. *Plos Computational Biology* 3:1083-1096.
- Carretta, J.V., K.A. Forney, M.S. Lowry, J. Barlow, J. Baker, D. Johnston, B. Hanson, R.L. Brownell, J. Robbins, D.K. Matilla, K. Ralls, M.M. Muto, D. Lynch, and L. Carswell. 2009. U.S. Dept. Commerce . U.S. Pacific Marine Mammal Stock Assessments: 2009. NOAA Tech. Memo. NMFS-SWFSC-453. 341 pp. <http://www.nmfs.noaa.gov/pr/sars/po2009.pdf>
- Chen, Z. and F. Blaabjerg. 2009. Wind farm - A power source in future power systems. *Renewable and Sustainable Energy Reviews* 13: 1288-1300.
- Chung-Davidson, Y. W., M. B. Bryan, J. Teeter, C. N. Bedore, and W. M. Li. 2008. Neuroendocrine and behavioral responses to weak electric fields in adult sea lampreys (*Petromyzon marinus*). *Hormones and Behavior* 54:34-40.
- Chung-Davidson, Y. W., S. S. Yun, J. Teeter, and W. M. Li. 2004. Brain pathways and behavioral responses to weak electric fields in parasitic sea lampreys (*Petromyzon marinus*). *Behavioral Neuroscience* 118:611-619.
- Cipriano, F. 2009. *Atlantic white-sided Dolphin (Lagenorhynchus acutus)*. Academic Press, San Diego, CA.
- Clark, T. B., W. D. Smith, and J. J. Bizzarro. 2006. *Mobula tarapacana*. International Union for Conservation of Nature and Natural Resources. Internet website: <http://www.iucnredlist.org/apps/redlist/details/60199/0>. Accessed: 27 April 2010.

- Cliff, G. and S. F. J. Dudley. 1992. Protection against shark attack in South Africa, 1952-90. *Australian Journal of Marine and Freshwater Research* 43:263-272.
- CMACS. 2003. A baseline assessment of electromagnetic fields generated by offshore wind farm cables. University of Liverpool, Centre for Marine and Coastal Studies. Rep. No. COWRIE EMF-01-2002 66. 71 pp.
- Collette, B. B. and G. Klein-MacPhee. 2002. *Bigelow and Schroeder's Fishes of the Gulf of Maine*. Third edition. Smithsonian Institution Press, Washington, DC.
- Collin, S. P. and D. Whitehead. 2004. The functional roles of passive electroreception in non-electric fishes. *Animal Biology* 54:1-25.
- Compagno, L. J. V. 1984. *Sharks of the World: An Annotated and Illustrated Catalogue of Shark Species Known to Date (Volume 4)*. Food and Agriculture Organization of the United Nations, Rome.
- Courtillot, V., G. Hulot, M. Alexandrescu, J.L. le Mouel, and J.L. Kirschvink. 1997. Sensitivity and evolution of sea turtle magnetoreception: observations, modeling and constraints from geomagnetic secular variation. *Terra Nova* 9: 203-207.
- Dawson, B. G., G. W. Heyer, R. E. Eppi, and A. J. Kalmijn. 1980. Field experiments on electrically evoked feeding responses in the dogfish shark, *Mustelus canis*. *Biological Bulletin* 159:482-482.
- Delgado, J. M. R. 1985. Biological Effects of Extremely Low Frequency Electromagnetic Fields. *Journal of Bioelectricity* 4:75.
- Department of Energy and Climate Control. 2010. Revised Draft National Policy Statement for Renewable Energy Infrastructure (EN-3).
- Diebel, C. E., R. Proksch, C. R. Green, P. Neilson, and M. M. Walker. 2000. Magnetite defines a vertebrate magnetoreceptor. *Nature* 406:299-302.
- Dittman, A. H. and T. P. Quinn. 1996. Homing in Pacific salmon: Mechanisms and ecological basis. *Journal of Experimental Biology* 199:83-91.
- DOE. 2009. Report to Congress on the Potential Environmental Effects of Marine and Hydrokinetic Energy Technologies. Prepared in response to the Energy Independence and Security Act of 2007, Section 633(b). Final report. US Department of Energy. 143 pp.
- DONG. 2006. Danish Offshore Wind – Key Environmental Issues. The Danish Energy Authority and the Danish Forest and Nature Agency, DONG Energy, Vattenfall.
- DONG Energy and Vattenfall A/S. 2006. Review Report 2005 The Danish Offshore Wind Farm Demonstration Project: Horns Rev and Nysted Offshore Wind Farms Environmental impact assessment and monitoring. Prepared for The Environmental Group of the Danish

Offshore Wind Farm Demonstration Projects. <http://www.ens.dk/en-US/supply/Renewable-energy/WindPower/offshore-Wind-Power/Environmental-Impacts/Sider/Forside.aspx>

Duman, C. H. and D. Bodznick. 1996. A role for GABAergic inhibition in electrosensory processing and common mode rejection in the dorsal nucleus of the little skate, *Raja erinacea*. *Journal of Comparative Physiology a-Neuroethology Sensory Neural and Behavioral Physiology* 179:797-807.

Ellis, J.K. 2003. Diet of the sandbar shark, *Carcharhinus plumbeus*, in Chesapeake Bay and adjacent waters. Master's thesis. Virginia Institute of Marine Science, College of William and Mary, Gloucester Point, Virginia.

Enger, P. S., L. Kristensen, and O. Sand. 1976. Perception of weak electric DC currents by European eel (*Anguilla anguilla*). *Comparative Biochemistry and Physiology a-Physiology* 54:101-103.

ENTSOE (European Network of Transmission System Operators for Electricity). 2010. Ten-year Network Development Plan 2010-2020. http://www.entsoe.eu/fileadmin/user_upload/library/SDC/TYNDP/TYNDP-final_document.pdf

EWEA (European Wind Energy Association). 2009. Oceans of Opportunity. Harnessing Europe's largest domestic energy resource. <http://www.ewea.org/index.php?id=178>

EWEA (European Wind Energy Association). 2011a. The European offshore wind industry key trends and statistics 2010. <http://www.ewea.org/index.php?id=1861>

EWEA (European Wind Energy Association). 2011b. Operational offshore wind farms in Europe, end 2010. <http://www.ewea.org/index.php?id=1861>

Exponent, Inc. 2001. Hudson Energy Project: Evaluation of Potential Environmental Effects of Proposed HVDC Submarine Cable Systems.

Exponent, Inc. 2004. Post-Construction Monitoring: DC Magnetic Fields Associated with the Operation of the Cross-Sound Submarine Cable System and DC and AC Magnetic Fields Associated with the Operation of the Cross-Sound Converter Station and Land Cable System.

Exponent Inc. and Hatch Ltd. 2009. Electric and Magnetic Fields (EMF), Considerations and Field Models for the Naikun Offshore Wind Energy Project. Government of British Columbia, British Columbia. 53 pp.

Fields, R. D. 1982. Electroreception in the ratfish (subclass Holocephali) : anatomical, behavioral, and physiological studies. Thesis (M.A.). Biological Sciences Dept., San Jose State University, San Jose, CA. 636

Fields, R. D., T. H. Bullock, and G. D. Lange. 1993. Ampullary sense organs, peripheral, central and behavioral electroreception in chimeras (*Hydrolagus*, Holocephali, Chondrichthyes). *Brain Behavior and Evolution* 41:269-289.

- Fields, R. D., K. D. Fields, and M. C. Fields. 2007. Semiconductor gel in shark sense organs? *Neuroscience Letters* 426:166-170.
- Fields, R. D. and G. D. Lange. 1980. Electroreception in the ratfish (*Hydrolagus colliei*). *Science* 207:547-548.
- Filer, J. L., C. G. Booker, and D. W. Sims. 2008. Effects of environment on electric field detection by small spotted catshark *Scyliorhinus canicula* (L.). *Journal of Fish Biology* 72:1450-1462.
- Formicki, K., M. Sadowski, A. Tanski, A. Korzelecka-Orkisz, and A. Winnicki. 2004. Behaviour of trout (*Salmo trutta* L.) larvae and fry in a constant magnetic field. *Journal of Applied Ichthyology* 20:290.
- Formicki, K. and A. Winnicki. 1998. Reactions of fish embryos and larvae to constant magnetic fields. *Italian Journal of Zoology* 65:479.
- Fritsch, B., M. D. C. Decaprona, K. Wachtler, and K. H. Kortje. 1984. Neuroanatomical evidence for electroreception in lampreys. *Zeitschrift Fur Naturforschung C-a Journal of Biosciences* 39:856-858.
- Froese, R. and D. Pauly. 2010. FishBase. WorldFish Center and Food and Agriculture Organization of the United nations (FAO). Internet website: <http://fishbase.org>. Accessed: April 2010.
- Garg, T. K., N. Agarwal, and S. Rai. 1995. Effect of Magnetically Restructured Water on the Liver of a Catfish *Clarias Batrachus*. *Electro- and Magnetobiology* 14.
- Gertseva, V. V. and V. I. Gertsev. 2002. A model of fish population distribution in the space of inhabitation. *Ecological Modelling* 147:161-170.
- Gill, A.B. and M. Bartlett. 2010. Literature review on the potential effects of electromagnetic fields and subsea noise from marine renewable energy developments on Atlantic salmon, sea trout and European eel. Scottish Natural Heritage Commissioned Report No. 401.
- Gill, A. B., I. Gloyne-Phillips, K. J. Neal, and J. A. Kimber. 2005. The potential effects of electromagnetic fields generated by sub-sea power cables associated with offshore wind farm developments on electrically and magnetically sensitive marine organisms - a review. Collaborative Offshore Wind Research into the Environment (COWRIE), Ltd, UK. 128 pp.
- Gill, A. B., Y. Huang, I. Gloyne-Phillips, J. Metcalfe, V. Quayle, J. Spencer, and V. Wearmouth. 2009. COWRIE 2.0 Electromagnetic Fields (EMF) Phase 2: EMF-sensitive fish response to EM emissions from sub-sea electricity cables of the type used by the offshore renewable energy industry. Cowrie Ltd. Cowrie-EMF-1-06. 128 pp.
- Gill, A. B. and A. A. Kimber. 2005. The potential for cooperative management of elasmobranchs and offshore renewable energy development in UK waters. *Journal of the Marine Biological Association of the United Kingdom* 85:1075-1081.

- Gill, A. B. and H. Taylor. 2001. The potential effects of electromagnetic fields generated by cabling between offshore wind turbines upon elasmobranch fishes. Countryside Council for Wales. Contract Science Report 488. 60 pp.
- GMFMC (Gulf of Mexico Fisheries Management Council). 2004. Final Environmental Impact Statement for the Generic Essential Fish Habitat Amendment to the Fishery Management Plans of the Gulf of Mexico.
- Goff, M., M. Salmon, and K. J. Lohmann. 1998. Hatchling sea turtles use surface waves to establish a magnetic compass direction. *Animal Behaviour* 55:69-77.
- Grubbs, R.D., J.A. Musick, C.L. Conrath, and J.G. Romine. 2007. Long-Term Movements, Migration, and Temporal Delineation of a Summer Nursery for Juvenile Sandbar Sharks in the Chesapeake Bay Region. In: McCandless, C.T., N.E. Kohler, and H.L. Pratt, Jr. (eds.) Shark nursery grounds of the Gulf of Mexico and the East coast of the United States. American Fisheries Society Symposium 50. American Fisheries Society. Bethesda, Maryland. 402 pp.
- Haine, O. S., P. V. Ridd, and R. J. Rowe. 2001. Range of electrosensory detection of prey by *Carcharhinus melanopterus* and *Himantura granulata*. *Marine and Freshwater Research* 52:291-296.
- Haugh, C. V. and M. M. Walker. 1998. Magnetic discrimination learning in rainbow trout (*Oncorhynchus mykiss*). *Journal of Navigation* 51:35-45.
- Hays, G. C., S. Akesson, A. C. Broderick, F. Glen, B. J. Godley, F. Papi, and P. Luschi. 2003. Island-finding ability of marine turtles. *Proceedings of the Royal Society of London Series B-Biological Sciences* 270:S5-S7.
- Hays, G. C., A. C. Broderick, B. J. Godley, P. Lovell, C. Martin, B. J. McConnell, and S. Richardson. 2002. Biphasal long-distance migration in green turtles. *Animal Behaviour* 64:895-898.
- Heyer, G. W., M. C. Fields, R. D. Fields, and A. J. Kalmijn. 1981. Field experiments on electrically evoked feeding responses in the pelagic blue shark, *Prionace glauca*. *Biological Bulletin* 161:344-345.
- Hjelmstad, G. O., G. Parks, and D. Bodznick. 1996. Motor corollary discharge activity and sensory responses related to ventilation in the skate vestibulolateral cerebellum: Implications for electrosensory processing. *Journal of Experimental Biology* 199:673-681.
- Hodson, R.B. 2000. Magnetoreception in the short-tailed stingray, *Dasyatis brevicaudata*. MSc Thesis, University of Auckland, New Zealand.
- Holthuis, L. B. 1991. FAO Species Catalogue: Marine Lobsters of the World. An Annotated and Illustrated Catalogue of Species of Interest to Fisheries Known to date. Food and Agriculture Organization of the United Nations Fisheries Synopsis No. 125, Volume 13. 227 pp.

- Huang, Y. 2005. Electromagnetic Simulations of 135-kV Three Phase Submarine Power Cables. Center for Marine and Coastal Studies, Ltd. Prepared for Sweden Offshore.
- Hui, C.A. 1994. Lack of Association between Magnetic Patterns and the Distribution of Free-Ranging Dolphins. *Journal of Mammalogy* (75):399-405.
- ICES (International Committee on Electromagnetic Safety). 2002. IEEE Standard for Safety Levels with Respect to Human Exposure to Electromagnetic Fields 0 to 3 kHz C95. 6-2002. Piscataway, NJ: IEEE, 2002.
- IEEE. 1988. Standard Dictionary of Electrical and Electronics Terms, 4th Ed., New York: IEEE.
- Irwin, W. P., A. J. Horner, and K. J. Lohmann. 2004. Magnetic field distortions produced by protective cages around sea turtle nests: unintended consequences for orientation and navigation? *Biological Conservation* 118:117-120.
- Irwin, W. P. and K. J. Lohmann. 2003. Magnet-induced disorientation in hatchling loggerhead sea turtles. *Journal of Experimental Biology* 206:497-501.
- Irwin, W. P. and K. J. Lohmann. 2005. Disruption of magnetic orientation in hatchling loggerhead sea turtles by pulsed magnetic fields. *Journal of Comparative Physiology a-Neuroethology Sensory Neural and Behavioral Physiology* 191:475-480.
- Johnsen, S. and K. J. Lohmann. 2005. The physics and neurobiology of magnetoreception. *Nature Reviews Neuroscience* 6:703-712.
- Johnson, C. S., B. L. Scronce, and M. W. McManus. 1984. Detection of DC electric dipoles in background fields by the nurse shark. *Journal of Comparative Physiology* 155:681-687.
- Kajiura, S. M. 2001a. Electoreception in carcharhinid and sphyrnid sharks. Thesis (Ph.D.). University of Hawaii at Manoa. 109 pp.
- Kajiura, S.M. 2001b. Head morphology and electrosensory pore distribution of carcharhinid and sphyrnid sharks. *Environmental Biology of Fishes* 61:125-133.
- Kajiura, S. M. 2003. Electoreception in neonatal bonnethead sharks, *Sphyrna tiburo*. *Marine Biology* 143:603-611.
- Kajiura, S. M. and T. P. Fitzgerald. 2009. Response of juvenile scalloped hammerhead sharks to electric stimuli. *Zoology* 112:241-250.
- Kajiura, S. M. and K. N. Holland. 2002. Electoreception in juvenile scalloped hammerhead and sandbar sharks. *Journal of Experimental Biology* 205:3609-3621.
- Kalmijn, A. 1984. Theory of electromagnetic orientation: a further analysis. *Comparative Physiology of Sensory Systems* (ed. Bolis, L., Keynes, R.D., Maddress, S.H.O.).
- Kalmijn, A.J. 1966. Electro-perception in sharks and rays. *Nature* 212:1232-&.

- Kalmijn, A. J. 1971. The electric sense of sharks and rays. *Journal of Experimental Biology* 55:371-383.
- Kalmijn, A.J. 1974. The detection of electric fields from inanimate and animate sources other than electric organs. In: Fessard, A. (ed.), *Handbook of sensory physiology*, vol. III (3): Electroreceptors and other specialized receptors in lower invertebrates. Berlin: Springer-Verlag. Pp. 147-200.
- Kalmijn, A.J. 1981. Biophysics of geomagnetic field detection. *Magnetics, IEEE Transactions on* 17(1): 1113-1124.
- Kalmijn, A.J. 1982. Electric and magnetic-field detection in elasmobranch fishes. *Science* 218:916-918.
- Kalmijn, A.J. 1988. Detection of weak electric fields. Pages 151-186 in J. Atema, R.R. Fay, A.N. Popper, and W.N. Tavolga (eds.) *Sensory Biology of Aquatic Animals*. Sp[ringer-Verlag. New York.
- Karlsson, L. 1985. Behavioral responses of European silver eels (*Anguilla anguilla*) to the geomagnetic field. *Helgolander Meeresuntersuchungen* 39:71-81.
- Katz, P. S. 2007. *Tritonia*. *Scholarpedia*, 2(6):3504. Internet website: <http://www.scholarpedia.org/article/Tritonia>. Accessed: March, 2010.
- Kimber, J. A., D. W. Sims, P. H. Bellamy, and A. B. Gill. 2009. Male-female interactions affect foraging behaviour within groups of small-spotted catshark, *Scyliorhinus canicula*. *Animal Behaviour* 77:1435-1440.
- Kimber, J. A., D. W. Sims, P. H. Bellamy, and A. B. Gill. 2011. The ability of a benthic elasmobranch to discriminate between biological and artificial electric fields. *Marine Biology* 158:1-8.
- Kingsford, M. J., J. M. Leis, A. Shanks, K. C. Lindeman, S. G. Morgan, and J. Pineda. 2002. Sensory environments, larval abilities and local self-recruitment. *Bulletin of Marine Science* 70:309-340.
- Kirschvink, J. L. 1983. Biomagnetic geomagnetism. *Reviews of Geophysics* 21:672-675.
- Kirschvink, J. L. 1989. Magnetite biomineralization and geomagnetic sensitivity in higher animals - an update and recommendations for future study. *Bioelectromagnetics* 10:239-259.
- Kirschvink, J.L. 1990. Geomagnetic sensitivity in cetaceans: an update with live stranding records in the United States, *In* *Sensory Abilities of Cetaceans: Laboratory and Field Evidence* (J.A. Thomas and R.A. Kastelein, eds.) Plenum Press, New York, NY. 639-649 pp.
- Kirschvink, J. L. 1992. Constraints on biological effects of weak extremely-low-frequency electromagnetic-fields - comment. *Physical Review A* 46:2178-2184.

- Kirschvink, J. L. 1997. Magnetoreception: homing in on vertebrates. *Nature* 390:339-340.
- Kirschvink, J.L., A.E. Dizon, J.A. Westphal. 1986. Evidence from Strandings from Geomagnetic Sensitivity in Cetaceans. *J. Exp. Biol.*120: 1-24.
- Kirschvink, J. L. and J. L. Gould. 1981. Biogenic magnetite as a basis for magnetic-field detection in animals. *Biosystems* 13:181-201.
- Kirschvink, J. L. and H. A. Lowenstam. 1979. Mineralization and magnetization of chiton teeth - paleomagnetic, sedimentologic, and biologic implications of organic magnetite. *Earth and Planetary Science Letters* 44:193-204.
- Kirschvink, J.L. and M.M. Walker. 1985. Particle size considerations for magnetite based magnetoreceptors, In: Kirschvink JL, Jones DS and McFadden BS (eds.), *Magnetite Biomineralization and Magnetoreception in Organisms: A New Biomagnetism*. New York: Plenum Press, 243-254.
- Kirschvink, J. L., M. M. Walker, and C. E. Diebel. 2001. Magnetite-based magnetoreception. *Current Opinion in Neurobiology* 11:462-467.
- Kishida, R., H. Koyama, and R. C. Goris. 1988. Giant lateral-line afferent terminals in the electroreceptive dorsal nucleus of lampreys. *Neuroscience Research* 6:83-87.
- Klimley, A. P. 1993. Highly directional swimming by scalloped hammerhead sharks, *Sphyrna lewini*, and subsurface irradiance, temperature, bathymetry, and geomagnetic field. *Marine Biology* 117:22.
- Klimley, A. P., S. C. Beavers, T. H. Curtis, and S. J. Jorgensen. 2002. Movements and swimming behavior of three species of sharks in La Jolla Canyon, California. *Environmental Biology of Fishes* 63:117-135.
- Klimley, A. P., R. L. Kihlsinger, and J. T. Kelly. 2005. Directional and non-directional movements of bat rays, *Myliobatis californica*, in Tomales Bay, California. *Environmental Biology of Fishes* 74:79-88.
- Klinowska, M. 1985. Cetacean live stranding sites related to geomagnetic topography. *Aquatic Mammals* (1):27-32.
- Klinowska, M. 1990. Geomagnetic orientation in cetaceans: behavioral evidence, In *Sensory Abilities of Cetaceans: Laboratory and Field Evidence* (J.A. Thomas and R.A. Kastelein, eds.). Plenum Press. New York, NY. 651-663 pp.
- Koops, F. B. J. 2000. Electric and Magnetic fields in Consequence of Undersea Power Cables. *Effects of Electromagnetic Fields on the Living Environment: Proceedings of the International Seminar on Effects of Electromagnetic Field on the Living Environment*.
- Koyama, H., R. Kishida, R. Goris, and T. Kusunoki. 1993. Giant terminals in the dorsal octavolateralis nucleus of lampreys. *Journal of Comparative Neurology* 335:245-251.

- Kullnick, U. H. 2000. Influences of Electric and Magnetic Fields on Aquatic Ecosystems. Effects of Electromagnetic Fields on the Living Environment: Proceedings of the International Seminar on Effects of Electromagnetic Field on the Living Environment.
- Kuzhetsov, V. I. 1999. Vegetative responses of dolphin to changes in permanent magnetic field. *Biofizika* 44:496-502.
- Levin, M. and S. G. Ernst. 1997. Applied DC magnetic fields cause alterations in the time of cell divisions and developmental abnormalities in early sea urchin embryos. 18:8.
- Light, P., M. Salmon, and K. J. Lohmann. 1993. Geomagnetic orientation of loggerhead sea turtles - evidence for an inclination compass. *Journal of Experimental Biology* 182:1-9.
- Lohmann, K. J. 1984. Magnetic remanence in the western Atlantic spiny lobster, *Panulirus argus*. *Journal of Experimental Biology* 113:29-41.
- Lohmann, K. J. 1985. Geomagnetic-field detection by the western Atlantic spiny lobster, *Panulirus argus*. *Marine Behaviour and Physiology* 12:1-17.
- Lohmann, K. J. 1991. Magnetic orientation by hatchling loggerhead sea turtles (*Caretta caretta*). *Journal of Experimental Biology* 155:37-49.
- Lohmann, K. J., S. D. Cain, S. A. Dodge, and C. M. F. Lohmann. 2001. Regional magnetic fields as navigational markers for sea turtles. *Science* 294:364-366.
- Lohmann, K. J., J. T. Hester, and C. M. F. Lohmann. 1999. Long-distance navigation in sea turtles. *Ethology Ecology & Evolution* 11:1-23.
- Lohmann, K. J. and C. M. F. Lohmann. 1993. A light-independent magnetic compass in the leatherback sea turtle. *Biological Bulletin* 185:149-151.
- Lohmann, K. J. and C. M. F. Lohmann. 1994a. Acquisition of magnetic directional preference in hatchling loggerhead sea turtles. *Journal of Experimental Biology* 190:1-8.
- Lohmann, K. J. and C. M. F. Lohmann. 1994b. Detection of magnetic-inclination angle by sea turtles - a possible mechanism for determining latitude. *Journal of Experimental Biology* 194:23-32.
- Lohmann, K. J. and C. M. F. Lohmann. 1996a. Detection of magnetic field intensity by sea turtles. *Nature* 380:59-61.
- Lohmann, K. J. and C. M. F. Lohmann. 1996b. Orientation and open-sea navigation in sea turtles. *Journal of Experimental Biology* 199:73-81.
- Lohmann, K. J., C. M. F. Lohmann, L. M. Ehrhart, D. A. Bagley, and T. Swing. 2004. Animal behaviour - Geomagnetic map used in sea turtle navigation. *Nature* 428:909-910.

- Lohmann, K. J., C. M. F. Lohmann, and C. S. Endres. 2008c. The sensory ecology of ocean navigation. *Journal of Experimental Biology* 211:1719-1728.
- Lohmann, K. J., C. M. F. Lohmann, and N. F. Putman. 2007. Magnetic maps in animals: nature's GPS. *Journal of Experimental Biology* 210:3697-3705.
- Lohmann, K. J., P. Luschi, and G. C. Hays. 2008b. Goal navigation and island-finding in sea turtles. *Journal of Experimental Marine Biology and Ecology* 356:83-95.
- Lohmann, K. J., N. D. Pentcheff, G. A. Nevitt, G. D. Stetten, R. K. Zimmerfaust, H. E. Jarrard, and L. C. Boles. 1995. Magnetic orientation of spiny lobsters in the ocean - experiments with undersea coil systems. *Journal of Experimental Biology* 198:2041-2048.
- Lohmann, K. J., N. F. Putman, and C. M. F. Lohmann. 2008a. Geomagnetic imprinting: A unifying hypothesis of long-distance natal homing in salmon and sea turtles. *Proceedings of the National Academy of Sciences of the United States of America* 105:19096-19101.
- Lohmann, K. J. and A. O. D. Willows. 1987. Lunar-modulated geomagnetic orientation by a marine mollusk. *Science* 235:331-334.
- Lohmann, K. J., A. O. D. Willows, and R. B. Pinter. 1991. An identifiable molluscan neuron responds to changes in earth-strength magnetic-fields. *Journal of Experimental Biology* 161:1-24.
- Lohmann, K. J., B. E. Witherington, C. M. F. Lohmann, and M. Salmon. 1997. Orientation, navigation, and natal beach homing in sea turtles. Pages 107-135 *in* P. Lutz and J. Musick, editors. *The Biology of Sea Turtles*. CRC Press, Boca Raton.
- Lowe, C. G., R. N. Bray, and D. R. Nelson. 1994. Feeding and associated electrical behavior of the pacific electric ray *Torpedo californica* in the field. *Marine Biology* 120:161-169.
- LOWENSTAM, H. A. 1962. Magnetite in Denticle Capping in Recent Chitons (Polyplacophora). *Geological Society of America Bulletin* 73:435-438.
- Lu, J. and H. M. Fishman. 1994. Interaction of apical and basal membrane ion channels underlies electroreception in ampullary epithelia of skates. *Biophysical Journal* 67:1525-1533.
- Luschi, P., S. Akesson, A.C. Broderick, F. Glen, B.J. Godley, F. Papi, and G.C. Hays. 2001. Testing the navigational abilities of ocean migrants: displacement experiments on green sea turtles (*Chelonia mydas*). *Behavioral Ecology and Sociobiology* 50: 528-534.
- Luschi, P., S. Benhamou, C. Girard, S. Ciccione, D. Roos, J. Sudre, and S. Benvenuti. 2007. Marine turtles use geomagnetic cues during open-sea homing. *Current Biology* 17:126-133.
- Lutcavage, M.E. and P.L. Lutz. 1997. *Diving Physiology In The Biology of Sea Turtles*. CRC Press. New York, NY. 277-296 pp.

- Madureira, A. 2004. Statistical Study of Power Quality in Wind Farms. International Conference on Renewable Energies and Power Quality. (ICREPQ'04), Paper No. 318. Barcelona, Spain.
- Malagoli, D., F. Gobba, and E. Ottaviani. 2003. Effects of 50-Hz magnetic fields on the signaling pathways of fMLP-induced shape changes in invertebrate immunocytes: the activation of an alternative "stress pathway". *Biochimica et biophysica acta* 1620:5.
- Malagoli, D., M. Lusvardi, F. Gobba, and E. Ottaviani. 2004. 50 Hz magnetic fields activate mussel immunocyte p38 MAP kinase and induce HSP70 and 90. *Comparative biochemistry and physiology. Toxicology & pharmacology : CBP* 137:4.
- Mann, S., N. H. C. Sparks, M. M. Walker, and J. L. Kirschvink. 1988. Ultrastructure, morphology and organization of biogenic magnetite from sockeye salmon, *Oncorhynchus nerka* - implications for magnetoreception. *Journal of Experimental Biology* 140:35-49.
- Marcotte, M. M. and C. G. Lowe. 2008. Behavioral responses of two species of sharks to pulsed, direct current electrical fields: Testing a potential shark deterrent. *Marine Technology Society Journal* 42:53-61.
- McCleave, J. D. and J. H. Power. 1978. Influence of weak electric and magnetic-fields on turning behavior in elvers of American eel *Anguilla rostrata*. *Marine Biology* 46:29-34.
- McGowan, D. W. and S. M. Kajiura. 2009. Electroreception in the euryhaline stingray, *Dasyatis sabina*. *Journal of Experimental Biology* 212:1544-1552.
- Medved, R.J. and J.A. Marshall. 1981. Feeding behavior and biology of young sandbar sharks, *Carcharhinus plumbeus* (Pisces, Carcharhinidae), in Chincoteague Bay, Virginia. *Fishery Bulletin* 79(3): 441-447.
- Metcalfe, J. D., B. H. Holford, and G. P. Arnold. 1993. Orientation of plaice (*Pleuronectes platessa*) in the open sea - evidence for the use of external directional clues. *Marine Biology* 117:559-566.
- Meyer, C. G., K. N. Holland, and Y. P. Papastamatiou. 2005. Sharks can detect changes in the geomagnetic field. *Journal of the Royal Society Interface* 2:129-130.
- Michel, J., H. Dunagan, C. Boring, E. Healy, W. Evans, J. M. Dean, A. McGillis, and J. Hain. 2007. Worldwide Synthesis and Analysis of Existing Information Regarding Environmental Effects of Alternative Energy Uses on the Outer Continental Shelf. U.S. Department of the Interior, Minerals Management Service, Herndon, VA. MMS OCS Report 2007-038. 254 pp.
- Miller, D. J. and R. N. Lea. 1972. Guide to the coastal marine fishes of California. Calif. Dept. of Fish and Game Fish Bull.157. Montgomery, J. C. 1984a. Frequency-response characteristics of primary and secondary neurons in the electrosensory system of the thornback ray. *Comparative Biochemistry and Physiology a-Physiology* 79:189-195.

- Montgomery, J. C. and D. Bodznick. 1993. Hindbrain circuitry mediating common-mode suppression of ventilatory reafference in the electrosensory system of the little skate *Raja erinacea*. *Journal of Experimental Biology* 183:203-215.
- Moore, A., S. M. Freake, and I. M. Thomas. 1990. Magnetic particles in the lateral line of the Atlantic salmon (*Salmo salar* L.). *Philosophical Transactions of the Royal Society of London Series B-Biological Sciences* 329:11-15.
- Moore, A. and W. D. Riley. 2009. Magnetic particles associated with the lateral line of the European eel *Anguilla anguilla*. *Journal of Fish Biology* 74:1629-1634.
- Muraveiko, V. M. 1984. Functional-properties of lamprey electroreceptors. *Neurophysiology* 16:95-99.
- NGDC (National Geophysical Data Center) 2010. Geomagnetism Frequently Asked Questions. Internet website: <http://www.ngdc.noaa.gov/geomag/faqgeom.shtml>. Accessed: April, 2010.
- Nelson, J.S., E.J. Crossman, H. Espinosa-Pérez, L.T. Findley, C.R. Gilbert, R.N. Lea, and D. Williams. 2004. Common and scientific names of fishes from the United States, Canada, and Mexico. Sixth Edition. American Fisheries Society. Special Publication 29, Bethesda, Maryland.
- New, J. G. 1990. Medullary electrosensory processing in the little skate. 1. Response characteristics of neurons in the dorsal octavolateralis nucleus. *Journal of Comparative Physiology a-Sensory Neural and Behavioral Physiology* 167:285-294.
- New, J. G. 1994. Electric organ discharge and electrosensory reafference in skates. *Biological Bulletin* 187:64-75.
- New, J. G. and T. C. Tricas. 1997. Electroreceptors and Magnetoreceptors: Morphology and Function. Pages 741-758 in N. Sperlakis, editor. *Cell Physiology Source Book*, 2nd ed. Academic Press, San Diego.
- Nexans. 2009. Nexans Norway AS, Submarine Power Cable Projects, Energy Division. Presentation on Cable and Umbilical Systems for Offshore Applications. Bremerhaven: Nexans Norway AS, April 21, 2009.
- NIRAS Consulting Engineers and Planners A/S. 2009. Barrow Offshore Wind Farm. Post Construction Monitoring Report. Year 2.
- Nishi, T. and G. Kawamura. 2005. *Anguilla japonica* is already magnetosensitive at the glass eel phase. *Journal of Fish Biology* 67:1213-1224.
- Nishi, T. and G. Kawamura. 2006. Magnetosensitivity in the darkbanded rockfish *Sebastes inermis*. *Nippon Suisan Gakkaishi* 72:27-33.

- Nishi, T., G. Kawamura, and K. Matsumoto. 2004. Magnetic sense in the Japanese eel, *Anguilla japonica*, as determined by conditioning and electrocardiography. *Journal of Experimental Biology* 207:2965-2970.
- Nishi, T., G. Kawamura, and S. Sannomiya. 2005a. Anosmic Japanese eel *Anguilla japonica* can no longer detect magnetic fields. *Fisheries Science* 71:101-106.
- NMFS. 1998. Recovery Plan for the Shortnose Sturgeon (*Acipenser brevirostrum*). Prepared by the Shortnose Sturgeon Recovery Team for the National Marine Fisheries Service, Silver Spring, MD. 104pp.
- NMFS. 2005. Updated status of federally listed ESUs of West Coast salmon and steelhead. U.S. Dept. Commerce, NOAA, National Marine Fisheries Service (NMFS). NOAA Tech. Memo. NMFS-NWFSC-66. 598 pp.
- NMFS. 2010a. NOAA Fisheries, Office of Protected Resources: Species Under the Endangered Species Act (ESA). Internet website: <http://www.nmfs.noaa.gov/pr/species/esa/>. Accessed: March 2010.
- NMFS. 2010b. NOAA Fisheries Service: Office of Habitat Conservation, Habitat Protection Division, Essential Fish Habitat (EFH). Internet website: <http://www.nmfs.noaa.gov/habitat/habitatprotection/efh/>. Accessed: March 2010.
- NMFS. 2010c. FishWatch: US Seafood Facts. U.S. Dept. Commer., NOAA, National Marine Fisheries Service (NMFS). Internet website: <http://www.nmfs.noaa.gov/fishwatch/>. Accessed: April 2010.
- NSCOGI (North Seas Countries' Offshore Grid Initiative). 2010. Memorandum of Understanding. http://www.entsoe.eu/fileadmin/user_upload/library/news/MoU_North_Seas_Grid/101203_MoU_of_the_North_Seas_Grid_Initiative.pdf
- OSI (Ocean Surveys, Inc.) 2009. Final Report. Magnetic Intensity Study. Long Island Replacement Cables - Sheffield Harbor and Long Island Sound, Norwalk, Connecticut. OSI Report #09ES074.
- Oceana. 2010. Key Loggerhead Habitat Areas. Website. <http://na.oceana.org/en/our-work/protect-marine-wildlife/sea-turtles/learn-act/key-loggerhead-habitat-areas>
- Öhman, M. C., P. Sigray, and H. Westerberg. 2007. Offshore windmills and the effects of electromagnetic fields on fish. *Ambio* 36:630-633.
- OSPAR (Convention for the Protection of the Marine Environment of the North-East Atlantic). 2008. OSPAR Guidance on Environmental Considerations for Offshore Wind Farm Development. http://data.offshorewind.co.uk/white_papers/

- Ottaviani, E., D. Malagoli, A. Ferrari, D. Tagliazucchi, A. Conte, and F. Gobba. 2002. 50 Hz magnetic fields of varying flux intensity affect cell shape changes in invertebrate immunocytes: the role of potassium ion channels. *Bioelectromagnetics* 23:5.
- Packer, D. B., C. Zetlin, and J. Vitaliano. 2003a. Essential fish habitat source document: Thorny skate, *Amblyraja radiata*, life history and habitat characteristics. NOAA Technical Memorandum Memo NMFS NE, Woods Hole, MA. 39 pp.
- Packer, D. B., C. Zetlin, and J. Vitaliano. 2003b. Essential fish habitat source document: Barndoor skate, *Dipturus laevis*, life history and habitat characteristics. NOAA Technical Memorandum Memo NMFS NE, Woods Hole, MA. 23 pp.
- Packer, D. B., C. Zetlin, and J. Vitaliano. 2003c. Essential fish habitat source document: Little skate, *Leucoraja erinacea*, life history and habitat characteristics. NOAA Technical Memorandum Memo NMFS NE, Woods Hole, MA. 66 pp.
- Packer, D. B., C. Zetlin, and J. Vitaliano. 2003d. Essential fish habitat source document: Rosette skate, *Leucoraja garmani virginica*, life history and habitat characteristics. NOAA Technical Memorandum Memo NMFS NE, Woods Hole, MA. 17 pp.
- Packer, D. B., C. Zetlin, and J. Vitaliano. 2003e. Essential fish habitat source document: Winter skate, *Leucoraja ocellata*, life history and habitat characteristics. NOAA Technical Memorandum Memo NMFS NE, Woods Hole, MA. 57 pp.
- Packer, D. B., C. Zetlin, and J. Vitaliano. 2003f. Essential fish habitat source document: Smooth skate, *Malacoraja senta*, life history and habitat characteristics. NOAA Technical Memorandum Memo NMFS NE, Woods Hole, MA. 26 pp.
- Packer, D. B., C. Zetlin, and J. Vitaliano. 2003g. Essential fish habitat source document: Clearnose skate, *Raja eglanteria*, life history and habitat characteristics. NOAA Technical Memorandum Memo NMFS NE, Woods Hole, MA. 50 pp.
- Pals, N., R. C. Peters, and A. A. C. Schoenhage. 1982. Local geo-electric fields at the bottom of the sea and their relevance for electrosensitive fish. *Netherlands Journal of Zoology* 32:479-494.
- Pals, N., P. Valentijn, and D. Verwey. 1982a. Orientation reactions of the dogfish, *Scyliorhinus canicula*, to local electric fields. *Netherlands Journal of Zoology* 32:495-512.
- Papathanassiou, S. A. and Papadopoulos. 2006. Harmonic Analysis in a power system with wind generation. *IEEE Trans on Power Delivery* 21: 2006-2016. Papi, F., P. Luschi, S. Akesson, S. Capogrossi, and G. C. Hays. 2000. Open-sea migration of magnetically disturbed sea turtles. *Journal of Experimental Biology* 203:3435-3443.
- Papi, F., P. Luschi, S. Akesson, S. Capogrossi, and G.C. Hays. 2000. Open-sea migration of magnetically disturbed sea turtles. *Journal of Experimental Biology* 203: 3435-3443.

- Patullo, B. W. and D. L. Macmillan. 2007. Crayfish respond to electrical fields. *Current Biology* 17:R83-R84.
- Pauley, G.B., D.A. Armstrong, and T.W. Heun. 1986. Species profiles: life histories and environmental requirements of coastal fishes and invertebrates (Pacific Northwest)—Dungeness crab. U.S. Fish and Wildlife Service. Biological Report 82(11.63). U.S. Army Corps of Engineers, TR EL-82-4. 20 pp.
- Paulin, M. G. 1995. Electroreception and the compass sense of sharks. *Journal of Theoretical Biology* 174:325-339.
- Peters, R. C., L. B. M. Eeuwes, and F. Bretschneider. 2007. On the electroreception threshold of aquatic vertebrates with ampullary or mucous gland electroreceptor organs. *Biological Reviews* 82:361-373.
- Peters, R. C. and H. P. Evers. 1985. Frequency-selectivity in the ampullary system of an elasmobranch fish (*Scyliorhinus canicula*). *Journal of Experimental Biology* 118:99-109.
- Poddubny, A.G. 1967 Sonic tags and floats as a means of studying fish response to natural environmental changes to fishing gears. In *Conference on fish behavior in relation to fishing techniques and tactics*, Bergen, Norway: 793-802, FAO, Rome. as cited in Gill et al. 2005.
- Poléo, A. B. S., H. F. Johannessen, and M. Harboe. 2001. High voltage direct current (HVDC) sea cables and sea electrodes: effects on marine life. Dept. of Biology, University of Oslo, Oslo, Norway. N-0316. 50 pp.
- Popescu, I. R. and A. O. D. Willows. 1999. Sources of magnetic sensory input to identified neurons active during crawling in the marine mollusc *Tritonia diomedea*. *Journal of Experimental Biology* 202:3029-3036.
- Presti, D. and J.D. Pettigrew. 1980. Ferromagnetic coupling to muscle receptors as a basis for geomagnetic field sensitivity in animals. *Nature* 285 (5760): 99-101.
- PSMFC (Pacific States Marine Fisheries Commission). 2010. White Sturgeon. Pacific States Marine Fisheries Commission. Internet website: http://www.psmfc.org/habitat/edu_wsturg_fact.html. Accessed: April 2010.
- Putman, N. F. and K. J. Lohmann. 2008. Compatibility of magnetic imprinting and secular variation. *Current Biology* 18:R596-R597.
- Quinn, T. P. 1980. Evidence for celestial and magnetic compass orientation in lake migrating sockeye salmon fry. *Journal of Comparative Physiology* 137:243-248.
- Quinn, T. P. and E. L. Brannon. 1982. The use of celestial and magnetic cues by orienting sockeye salmon smolts. *Journal of Comparative Physiology* 147:547-552.

- Quinn, T. P. and C. Groot. 1983. Orientation of chum salmon (*Oncorhynchus keta*) after internal and external magnetic-field alteration. Canadian Journal of Fisheries and Aquatic Sciences 40:1598-1606.
- Quinn, T. P., R. T. Merrill, and E. L. Brannon. 1981. Magnetic-field detection in sockeye salmon. Journal of Experimental Zoology 217:137-142.
- Quinn, T. P. and J. C. Ogden. 1984. Field evidence of compass orientation in migrating juvenile grunts (Haemulidae). Journal of Experimental Marine Biology and Ecology 81:181-192.
- Raschi, W. and W.H. Adams. 1988. Depth-related modifications in the electroreceptive system of the eurybathic skate, *Raja radiata* (Chondichthyes, Rajidae). Copeia: 116-123.
- Regnart, H. C. 1931. The lower limits of perception of electric currents by fish. Journal of the Marine Biological Association UK 17:415-420.
- Rommel, S. A. and J. D. McCleave. 1972. Oceanic electric-fields - perception by American eels. Science 176:1233.
- Rommel, S. A. and J. D. McCleave. 1973. Prediction of oceanic electric fields in relation to fish migration. Journal Du Conseil 35:27-31.
- Sadowski, M., A. Winnicki, K. Formicki, A. Sobocinski, and A. Tanski. 2007. The effect of magnetic field on permeability of egg shells of salmonid fishes. Acta ichthyologica et piscatorial 37: 129-135.
- Salyapongse, A., G. Hjelmstad, and D. Bodznick. 1992. 2nd-order electroreceptive cells in skates have response properties dependent on the configuration of their inhibitory receptive-fields. Biological Bulletin 183:349-349.
- Semm, P. and C. Demaine. 1986. Neurophysiological properties of magnetic cells in the pigeon's visual system. J. Comp. Physiol. 159: 619-625.
- Semm, D., D. Nohr, C. Demaine, and W. Wiltschko. 1984. Neural basis of the magnetic compass: interactions of visual, magnetic and vestibular inputs in the pigeon's brain. J. Comp. Physiol. A 155(3): 283-288.
- Silva, J. M., L.E. Zaffanella and J.P. Daigle. 2006. EMF Study: Long Island Power Authority (LIPA), Offshore Wind Project. 74 pp.
- Sisneros, J. A. and T. C. Tricas. 2000. Androgen-induced changes in the response dynamics of ampullary electrosensory primary afferent neurons. Journal of Neuroscience 20:8586-8595.
- Sisneros, J. A. and T. C. Tricas. 2002. Ontogenetic changes in the response properties of the peripheral electrosensory system in the Atlantic stingray (*Dasyatis sabina*). Brain Behavior and Evolution 59:130-140.

- Sisneros, J. A., T. C. Tricas, and C. A. Luer. 1998. Response properties and biological function of the skate electrosensory system during ontogeny. *Journal of Comparative Physiology a-Sensory Neural and Behavioral Physiology* 183:87-99.
- Skiles, D.D. 1985. The geomagnetic field: its nature, history, and biological relevance. In Kirschvink et al. (eds.). *Magnetite biomineralization and magnetoreception in organisms, a new biomagnetism*. Plenum Press: New York and London, pp. 223-232.
- Skog, J. E., K. Koreman, B. Pääjärvi, T. Worzyk, and T. Andersröd. 2006. The NORNED HVDC Cable link between a power transmission highway between Norway and the Netherlands, presented at ENERGEX 2006, Stavanger, Norway, June 12-15, 2006.
- Sminkey, T.R. 1994. Age, growth, and population dynamics of the sandbar shark, *Carcharhinus plumbeus*, at different population levels. Doctoral dissertation. Virginia Institute of Marine Science, College of William and Mary, Gloucester Point, Virginia. *Cited in* Grubbs, et al. 2007.
- Steullet, P., D. H. Edwards, and C. D. Derby. 2007. An electric sense in crayfish? *Biological Bulletin* 213:16-20.
- Stillwell, C.E. and N.E. Kohler. 1993. Food habits of the sandbar shark *Carcharhinus plumbeus* off the U.S. northeast coast, with estimates of daily ration. *Fishery Bulletin* 91(1): 138-150.
- Tanski, A., K. Formicki, A. Korzelecka-Orkisz, and A. Winnicki. 2005. Spatial Orientation of Fish Embryos in Magnetic Field. *Electronic Journal of Ichthyology* 1:14.
- TPC (Tasmanian Planning Co.) 2001. Final Panel Report on Basslink Proposal. pp.
- Taylor, P. B. 1986. Experimental-evidence for geomagnetic orientation in juvenile salmon, *Oncorhynchus tshawytscha* Walbaum. *Journal of Fish Biology* 28:607-623.
- Teeter, J. H., R. B. Szamier, and M. V. L. Bennett. 1980. Ampullary electroreceptors in the sturgeon *Scaphirhynchus platyrhynchus* (Rafinesque). *Journal of Comparative Physiology* 138:213-223.
- Tesch, F. W. 1974. Influence of geomagnetism and salinity on directional choice of eels. *Helgolander Wissenschaftliche Meeresuntersuchungen* 26:382-395.
- Tricas, T. C. 1982. Bioelectric-mediated predation by swell sharks, *Cephaloscyllium ventriosum*. *Copeia*:948-952.
- Tricas, T. C. 2001. The neuroecology of the elasmobranch electrosensory world: Why peripheral morphology shapes behavior. Pages 77-92.
- Tricas, T. C. and J. E. McCosker. 1984. Predatory behavior of the white shark, *Carcharodon carcharias*, and notes on its biology. *Proceedings of the California Academy of Science* 43:221-238.

- Tricas, T. C., S. W. Michael, and J. A. Sisneros. 1995. Electrosensory optimization to conspecific phasic signals for mating. *Neuroscience Letters* 202:129-132.
- Tricas, T. C. and J. G. New. 1998. Sensitivity and response dynamics of elasmobranch electrosensory primary afferent neurons to near threshold fields. *Journal of Comparative Physiology a-Neuroethology Sensory Neural and Behavioral Physiology* 182:89-101.
- Ueda, K., Y. Maeda, M. Koyama, K. Yaskawa, and T. Tokui. 1986. Magnetic remanences in salmonid fish. *Bulletin of the Japanese Society of Scientific Fisheries* 52:193-198.
- Ueno, S., P. Lovsund, and P. A. Oberg. 1986. Effect of time-varying magnetic fields on the action potential in lobster giant axon. *Medical and Biological Engineering and Computing* 24.
- Ugolini, A. 2006. Equatorial sandhoppers use body scans to detect the earth's magnetic field. *Journal of Comparative Physiology a-Neuroethology Sensory Neural and Behavioral Physiology* 192:45-49.
- Ugolini, A. and A. Pezzani. 1995. Magnetic compass and learning of the y-axis (sea-land) direction in the marine isopod *Idotea baltica* Basteri. *Animal Behaviour* 50:295-300.
- USFWS. 2007. West Indian manatee (*Trichechus manatus*) 5-year review: summary and evaluation. U.S. Fish and Wildlife Service, Southeast Region, Jacksonville, FL. 86 pp.
- USFWS and GSMFC. 1995. Gulf Sturgeon Recovery Plan. US Fish and Wildlife Service and Gulf States Marine Fisheries Commission, Atlanta, Georgia. 170 pp.
- Uzdensky, A. B., O. Y. Kutko, and A. B. Kogan. 1997. Effect of Weak Extremely Low Frequency Magnetic Field on Isolated Crayfish Stretch Receptor Neuron: Nonlinear Dependence on Field Amplitude and Frequency. *Electromagnetic Biology and Medicine* 16:12.
- Vriens, A. and F. Bretschneider. 1979. Electrosensitivity of the lateral line of the European eel, *Anguilla anguilla* L. *Journal De Physiologie* 75:341-342.
- Walker, M. M. 1984. Learned magnetic field discrimination in yellowfin tuna, *Thunnus albacares*. *Journal of Comparative Physiology a-Neuroethology Sensory Neural and Behavioral Physiology* 155:673-679.
- Walker, M. M. 2008. A model for encoding of magnetic field intensity by magnetite-based magnetoreceptor cells. *Journal of Theoretical Biology* 250:85-91.
- Walker, M. M., C. E. Diebel, C. V. Haugh, P. M. Pankhurst, J. C. Montgomery, and C. R. Green. 1997. Structure and function of the vertebrate magnetic sense. *Nature* 390:371-376.
- Walker, M.M., D.E. Diebel, and J.L. Kirschvink. 2003. Detection and use of the earth's magnetic field by aquatic vertebrates, *in* *Sensory Processing in the Aquatic Environment*. S.P. Collin and N. Justin Marshall, eds. Springer-Verlag. NY. Pp. 53-74.

- Walker, M. M., C. E. Diebel, and J. L. Kirschvink. 2007. Sensory systems neuroscience. Pages 335-374 in T. J. Hara and B. Zielinski, editors. Sensory systems neuroscience: Fish Physiology, v. 25. Elsevier Academic Press, Amsterdam, Netherlands; Boston, MA.
- Walker, M. M., J. L. Kirschvink, S. B. R. Chang, and A. E. Dizon. 1984. A candidate magnetic sense organ in the yellowfin tuna, *Thunnus albacares*. *Science* 224:751-753.
- Walker, M.W., J.L. Kirschvink, G. Ahmed, A.E. Dizon. 1992. Evidence that fin whales respond to the geomagnetic field during migration. *Journal of Experimental Biology*. 171: 67-78.
- Walker, M. M., T. P. Quinn, J. L. Kirschvink, and C. Groot. 1988. Production of single-domain magnetite throughout life by sockeye salmon, *Oncorhynchus nerka*. *Journal of Experimental Biology* 140:51-63.
- Walker, M.M., C.E. Diebel, J.L. Kirschvink. 2003. Detection and Use of the Earth's Magnetic Field by Aquatic Vertebrates, In Sensory Processing in the Aquatic Environment. SP Collin and N. Justin Marshall, eds. Springer-Verlag. NY. 53-74 pp.
- Walker, R. and A. Judd. 2010. Strategic Review of Offshore Wind Farm Monitoring Data Associated with FEPA Licence Conditions. Cefas Environment and Ecosystems Division. <http://www.cefas.co.uk/publications/miscellaneous-publications/strategic-review-of-offshore-wind-farm-monitoring-data-associated-with-fepa-licence-conditions.aspx>
- Wang, J. H., S. D. Cain, and K. J. Lohmann. 2003. Identification of magnetically responsive neurons in the marine mollusc *Tritonia diomedea*. *Journal of Experimental Biology* 206:381-388.
- Wang, J. H., S. D. Cain, and K. J. Lohmann. 2004. Identifiable neurons inhibited by Earth-strength magnetic stimuli in the mollusc *Tritonia diomedea*. *Journal of Experimental Biology* 207:1043-1049.
- Waring, G.T., E. Josephson, K. Maze-Foley, P.E. Rosel (eds.). 2009. U.S. Atlantic and Gulf of Mexico Marine Mammal Stock Assessments- 2009. NOAA NMFS NE 213. 528 pp. <http://www.nefsc.noaa.gov/publications/tm/tm213/>
- Westerberg, H. 2000. Effect of HVDC cables on eel orientation. Pages 70-76 in Technische Eingriffe in marine Lebensraume. Bundesamtes für Naturschutz, Germany.
- Westerberg, H. and I. Langenfelt. 2008. Sub-sea power cables and the migration behavior of the European eel. *Fisheries Management and Ecology* 15: 369-375.
- Whitehead, D. L. 2002. Ampullary organs and electroreception in freshwater *Carcharhinus leucas*. *Journal of Physiology-Paris* 96:391-395.
- Willows, A. O. D. 1999. Shoreward orientation involving geomagnetic cues in the nudibranch mollusc *Tritonia diomedea*. *Marine and Freshwater Behaviour and Physiology* 32:181-192.

- Wiltschko, R. and W. Wiltschko. 1995. Magnetic orientation in animals. Springer, Berlin; New York.
- Yano, A. and S. Aoyagi. 2008. TOF-SIMS analysis of magnetic materials in chum salmon head. Pages 1100-1103.
- Yano, A., M. Ogura, A. Sato, Y. Sakaki, Y. Shimizu, N. Baba, and K. Nagasawa. 1997. Effect of modified magnetic field on the ocean migration of maturing chum salmon, *Oncorhynchus keta*. Marine Biology 129:523-530.
- Yano, K., H. Mori, K. Minamikawa, S. Ueno, S. Uchida, K. Nagai, M. Toda, and M. Masuda. 2000. Behavioral Response of Sharks to Electric Stimulation. Bulletin of Seikai National Fisheries Research Institute 78:13-30.
- Ye, S. R., J. W. Yang, and C. M. Chen. 2004. Effect of static magnetic fields on the amplitude of action potential in the lateral giant neuron of crayfish. International journal of radiation biology 80:699-708.
- Zimmerman, M. A. and J. D. McCleave. 1975. Orientation of elvers of American eels (*Anguilla rostrata*) in weak magnetic and electric fields. Helgolander Wissenschaftliche Meeresuntersuchungen 27:175-189.
- Zoeger, J., J. R. Dunn, and M. Fuller. 1981. Magnetic material in the head of the common pacific dolphin. Science 213:892-894.

7. GLOSSARY

Alternating current	Electric current flow that reverses direction periodically. In North America, the electricity in the power system and associated electric and magnetic fields oscillate 60 times per second, i.e., at a frequency of 60 Hertz (Hz). In Europe and Asia the frequency of electricity and these fields is 50 Hz.
Bioelectric fields	Electric fields that are produced directly by living organisms, i.e., of biological origin. The beating of a heart, the nerve impulses within an organism, and the uneven distribution of charged ions are examples of AC and DC electric fields of biological origin.
Bipolar system	A bipolar DC transmission system transmits power at two voltages with respect to ground, e.g., +500 kV and –500 kV.
Cable configuration	The spacing and alignment of undersea AC and DC cables.
Current flow	The flow of electricity in a conductor, i.e., the movement of electric charges or current. The rate of current flow is measured in amperes.
Direct current	Also known as static fields, direct current does not vary appreciably over time —i.e., their frequency is 0 Hz. Like alternating current, direct current is also produced by biological organisms, environmental sources, and our power system. Permanent magnets and direct currents (DC) flowing in conductors produce static DC magnetic fields. Electric field An electric field is created by the difference in electric potential (voltage) between the conductors in power cables. The strength of an electric field is expressed in units of volts per meter (V/m).
Electromagnetic field	The term electromagnetic field is frequently used to refer to electromagnetic energy across a wide frequency spectrum ranging from the earth's natural fields to cosmic radiation. Sometimes it refers to frequencies above about 100 kHz where electric and magnetic fields are coupled and radiate away from sources.
Electrosensitivity	ability to detect an electric field
EMF	Electromagnetic (EM) field
E/M sensitive species	species that is able to detect either an electric field or a magnetic field

Faraday's law	The proportional relationship between the rate of change of a magnetic field and the induction of an electric potential in a conducting loop.
Harmonic currents	Currents with frequencies that are multiples of the fundamental supply current frequency.
Harmonic frequency	A multiple of the fundamental frequency of an AC current or voltage. In power systems a harmonic frequency will be a multiple of 60 Hz (North America) or 50 Hz (Europe, Asia).
Impact	effect on or response to a stressor
Impact assessment	analysis of the effects of an action on environmental resources
Integrated return circuit	A configuration of a monopolar DC cable in which the low-voltage metallic conductor surrounds but is insulated from the high-voltage power conductor.
Induced electric fields	Induced electric fields are produced by the movement of charges in a magnetic field. In the marine environment, DC electric fields are induced by the natural movement of charges in seawater or ionic charges in organisms through the geomagnetic field (and as perhaps altered by DC cables). AC electric fields can also be induced in the marine environment by alternating magnetic fields of AC cables.
Law of Bio-Savart	a formula used to compute the magnetic field generated by a steady electric current
Lorentz force	The force that a magnetic field exerts on an electric charge that is perpendicular to both the velocity v of the charge q and the magnetic field B . No force is exerted on a stationary charge or a charge moving parallel to the magnetic field.
Magnetic field	Magnetic fields surround magnetic materials and electric currents. In magnetic materials and permanent magnets, the field is created by the coordinated spins of electrons and nuclei within iron atoms. A magnetic field can interact with moving electric charges to produce induced electric fields. Magnetic fields also interact with magnetic materials, e.g., opposite poles of magnets are pulled towards each other. A changing magnetic field can also give rise to an electric field, and vice versa. The magnitude of the magnetic field is expressed as magnetic flux density, also referred to as

	magnetic field strength. Magnetic field strength is expressed in units of gauss (G) or tesla (T).
Magnetic field anomalies	Local variations in the earth's geomagnetic field that may be produced by the presence of a wide variety of ferromagnetic sources, including shore-based structures (docks and jetties), sunken ships, pipelines, and ferromagnetic mineral deposits.
Magnetosensitivity	ability to detect magnetic fields
Maxwell's equations	a set of four (Gauss' law, Gauss' law for magnetism, Faraday's law of induction, and Ampère's law) partial differential equations that relate the electric and magnetic fields to their sources, charge density, and current density. See http://en.wikipedia.org/wiki/Maxwell's equations
Monopolar DC system	In a monopolar DC system, DC power is transmitted on a single high-voltage direct-current (HVDC) conductor at one voltage with respect to ground, say +400 kV. The circuit is completed by current return on a low-voltage return conductor.
Natural history	attributes of an organism's life history and behavior that define its interaction with the surrounding environment
Offshore renewable energy	energy derived from wind, waves, currents, or tides.
Risk assessment	quantitative or qualitative determination of risk or hazard related to a concrete situation. Depends on magnitude of potential loss and probability that loss will occur.
Subsea power cable	also subsea (undersea) cable, subsea (undersea) power line, transmission line. An electric cable located in the marine environment, usually buried in the seafloor.
Gauss	A unit of measure commonly used in scientific publications in North America to express the strength of a magnetic field. Gauss and tesla are intraconvertable by the expression $0.001 \text{ G} = 1 \text{ milligauss (mG)} = 0.1 \text{ microTesla } (\mu\text{T})$.
Geomagnetic field	The earth's geomagnetic field is the dominant source of DC magnetic fields in both land and marine environments. The background geomagnetic field at the earth's surface is a static field that largely originates from direct current (DC) flow in the liquid part of the earth's core and from metallic elements in the crust of the earth. The magnetic field of the earth has a dipole structure like that of a bar magnet, with the poles of the dipole closely

aligned with the geographic poles of the earth. This accounts for the orientation of a compass needle in the magnetic north – south direction.

Separate return cable

A cable used in a monopolar DC cable system for carrying return current between converters at opposite ends of the system. The return cable is connected to earth ground at one end of the system and is otherwise insulated from earth ground so that its opposite end is floating with respect to the separate high-voltage cable.

Tesla

A unit of measure of magnetic flux density commonly used in scientific publications. Tesla and gauss (the older cgs measure of magnetic flux density) are interconvertible by the expression $0.001 \text{ G} = 1 \text{ milligauss (mG)} = 0.1 \text{ microTesla } (\mu\text{T})$.

Vector fields

An important characteristic of electric and magnetic fields not shared by most other measured attributes of the environment is that they are vectors, that is, they are directional. This directional property explains why the magnetic field from a compass needle points in a north – south direction. Vector fields from different sources can cancel as well as add to each other, depending on their relative orientation.

Undersea cable

Also subsea cable, subsea power line, transmission line. An electric cable located in the marine environment, usually buried in the seafloor.

Wind project

Commonly used to describe a cluster of electricity-generating wind turbines connected to a common export cable. In European literature, the term wind farm is synonymous.

Appendices

Appendix A
Literature Search Results

Appendix A provides annotations of literature for the following topics:

- A-1 Power Cable Characteristics
- A-2 EMF Impacts
- A-3 General Electro- or Magnetosensitivity
- A-4 Elasmobranchs – Electric Sense
- A-5 Elasmobranchs – Magnetic Sense
- A-6 Other Fishes – Electric Sense
- A-7 Other Fishes – Magnetic Sense
- A-8 Marine Mammals – Electric Sense
- A-9 Marine Mammals – Magnetic Sense
- A-10 Sea Turtles – Magnetic Sense
- A-11 Invertebrates – Electric Sense
- A-12 Invertebrates – Magnetic Sense

Appendix A-1 Power Cable Characteristics

Andrulewicz, E. D., D. Napierska, and Z. Otremba. 2003. The environmental effects of the installation and functioning of the submarine SwePol Link HVDC transmission line: a case study of the Polish marine area of the Baltic Sea. *Journal of Sea Research* 49:337-345.

ANNOTATION: The SwePol Link 245-km \pm 450kV DC cable system crosses the Baltic Sea to connect converter stations in Slupsk, Poland and Karlshamm, Sweden. Andrulewicz et al. (2003) provides calculations of the DC magnetic field and a discussion of environmental monitoring. The paper reports that one year after installation "there had been no significant changes in zoobenthos species composition, abundance or biomass which could have been clearly related to cable installation."

Argo Environmental Ltd. 2007. Kaipara Harbor Marine Turbine Power Generation Project: Application for Resource Consents and Assessment of Environmental Effects. Crest Energy Limited, Auckland, New Zealand. 58 pp.

ANNOTATION: The Kaipara Harbour Marine Turbine Power Generation project generates power by 200 marine tidal turbines at the mouth of Kaipara Harbor, NZ. Power is carried to Puoto Point, NZ over a 7 km underwater 500kV DC cable system. No calculated DC magnetic field values are provided and the discussion of potential effects on marine habitat is cursory.

Bailey, W. H. 2006. Direct Evidence of Dr. William H. Bailey for the National Energy Board. 31 pp.

ANNOTATION: This report submitted to the National Energy Board of Canada summarizes the DC magnetic fields produced by the Juan de Fuca cables, and is the first to calculate the induced electrical potentials in seawater due to the movement of ocean currents over a DC cable. An evaluation of potential adverse impact of the DC magnetic field on marine species that distinguishes between detection of magnetic fields by sensory organs of certain marine species and systemic adverse effects is included. A comment in the FEIS on the potential impact of the magnetic field states "Marine species sensitive to magnetic fields may become disorientated if close (within 3 feet [1 m]) to the cable." (p. 2-6-2-7) for which no supporting studies were cited. The conclusion was that "impacts on species would be unlikely" (p. 3-18) and no mitigation was proposed.

Balog, G. 2009. Specialised in submarine projects - cable and umbilical systems for offshore applications. Internet website:
http://www.innovasjon Norge.no/Internasjonalisering_fs/Utekontorer/ReNEW/12_%20Nexans.pdf
f. Accessed: March 27, 2010.

ANNOTATION: This presentation summarizes Nexans capabilities and experience with undersea cable systems with examples of cable designs, including AC cables and IRC DC cable configurations

Baltic Cable. 2010. Welcome to Baltic Cable. Baltic Cable, A. B. Internet website: www.balticcable.com. Accessed: April, 2010.

ANNOTATION: This project website provides some limited information about this submarine DC cable project.

BERR. 2008. Review of cabling techniques and environmental effects applicable to the offshore wind farm industry. Department for Business Enterprise and Regulatory Reform, UK Government. 164 pp.

ANNOTATION: This technical report provides information about the undersea cables and installation techniques used for offshore wind facilities, and associated environmental effects.

Bonneville Power Administration. 2000. Environmental Clearance Memorandum for San Juan Cable Replacement Project. United States Government, Department of Energy, Washington, DC. 4 pp.

ANNOTATION: The San Juan Cable Replacement project connects Fidalgo Island and Lopez Island in Puget Sound with an 8.4 mile 69kV AC cable. No calculations were performed and no specific assessment of magnetic field effects on the marine environment was performed.

Bonneville Power Administration. 2007. Port Angeles-Juan de Fuca Transmission Project Final Environmental Impact Statement. Department of Energy, Office of Electricity Delivery and Energy Reliability and Bonneville Power Administration, Washington, DC. 156 pp.

ANNOTATION: This project comprises the 16.9 km portion of a ± 150 kV DC cable system underneath the Strait of Juan de Fuca in US waters that connects to the Port Angeles Substation. The information contained in the DEIS and FEIS is limited and largely references the more detailed calculations and environmental impact assessments performed in the course of permitting the 20 km portion of the cable system in Canadian waters. See Bailey 2006.

BPA. 1991. Corona and Field Effects Computer Program (Public Domain Software). USDOE, Bonneville Power Administration (BPA), P.O. Box 491-ELE, Vancouver, WA 98666.

ANNOTATION: The Bonneville Power Administration (BPA), an agency of the U.S. Department of Energy, developed these computer algorithms that calculate magnetic field levels

from AC cables. These algorithms have been shown to accurately predict electric and magnetic fields measured near power lines.

British Columbia Transmission Corporation. 2005. CPCN Application for Vancouver Island Transmission Reinforcement Project. British Columbia Transmission Corporation, Vancouver, BC. 136 pp.

ANNOTATION: The Vancouver Island Transmission Reinforcement Project involves several 230kV undersea self-contained fluid-filled underwater cable sections. One segment, 23.5 km long, is laid under the Strait of Georgia between EBT terminal in Tsawwassen, BC and the Taylor Bay Terminal on the eastern shore of Galiano Island. Approximately 12 km of this segment passes through US waters. There are currently seven cables on the existing submarine ROW (two sets of three single-phase 138 kV cables and one spare). BCTC proposes to remove one of the existing sets of 138 kV cables and replace these with a new set of three single-phase 230 kV cables. The new 230 kV cables will be installed underground between EBT and the shore, buried in the seabed to beyond the low tide line, and then laid directly on the seabed in deep water, all within the existing ROW. Another 230kV 3.9 km segment of underwater cable passes from Montague Terminal (MTG) on the western shore of Parker Island under the Trincomali Channel to Maracaibo Terminal (MBO) on the eastern shore of Salt Spring Island. As with the portion of the Project under the Strait of Georgia, there are currently seven cables on the existing ROW (two sets of three single-phase 138kV cables and one spare). Again, BCTC proposes to remove one of the existing sets of 138kV cables and replace these with a new set of three, single-phase 230kV cables. No evaluation of AC magnetic fields levels or effects on the marine environment are included.

Chen, Z. and F. Blaabjerg. 2009. Wind farm - A power source in future power systems. *Renewable and Sustainable Energy Reviews* 13:1288-1300.

ANNOTATION: A discussion of wind farm operations and control with particular reference to harmonics.

CMACS. 2003. A baseline assessment of electromagnetic fields generated by offshore wind farm cables. University of Liverpool, Centre for Marine and Coastal Studies. Rep. No. COWRIE EMF-01-2002 66. 71 pp.

ANNOTATION: This report was prepared by the Centre for Marine and Coastal Studies at the University of Liverpool, UK, and was commissioned by COWRIE (Collaborative Offshore Wind Research Into The Environment). The report provides a baseline assessment of electromagnetic fields (EMF) generated by offshore wind farm cables. Questions investigated included: (1) The likely EMF emitted from a undersea power cable, (2) methods to measure EMF in the field, (3) mitigation measures to reduce EMF, and (4) and consideration of requirements for the next stage of investigation into the effects of EMF on electrosensitive species.

Connecticut Siting Council. 2002a. Connecticut Siting Council Docket No. 224 Opinion, Decision, and Order. State of Connecticut, Connecticut Siting Council, New Britain, CT. 32 pp.

ANNOTATION: The replacement of Northeast Utilities' 138 kV Submarine Electric Transmission Cable System included three 138 kV AC cable circuits laid in parallel approximately 1,000 feet apart under Long Island Sound to connect substations in Norwalk, CT and Northport, NY. Each circuit consists of three insulated conductors bundled together within a single cable sheath. The cables are solid dielectric cables with cross-linked polyethylene insulation buried to a depth of six feet below the bed of Long Island Sound. If a cable could not be buried to the proposed six-foot depth, concrete mattresses or rock were placed over the area to protect the cables from damage. The project replaced two 138kV circuits insulated by dielectric fluid. See Institute for Sustainable Energy (2003).

Connecticut Siting Council. 2002b. Connecticut Siting Council Docket No. 208 Findings of Fact, Opinion, and Decision and Order. State of Connecticut, Connecticut Siting Council, New Britain, CT. 8 pp.

ANNOTATION: The Cross Sound Cable project's 24 mile +150 kV DC cable system crosses Long Island Sound to connect converter stations in New Haven, CT and Brookhaven, NY. Most of the cable length was buried during construction except at a few locations. The cable at these location was buried subsequently. An evaluation of potential magnetic field effects on marine species is included.

ENTSOE. 2010. Ten-year Network Development Plan 2010-2020. European Network of Transmission System Operators for Electricity. 287 pp.

ANNOTATION: The European Network of Transmission System Operators for Electricity prepared a ten-year plan for integration of the system throughout Europe. As the shallower waters of the Baltic and North Seas have attracted substantial interest for offshore wind development, ENTSOE has planned for the installation of several undersea cables to connect these facilities and to improve the market integration of countries adjacent to these seas.

EWEA. 2009. Oceans of Opportunity. Harnessing Europe' largest domestic energy resource. European Wind Energy Association. 69 pp.

ANNOTATION: EWEA emphasizes that development of offshore wind resources is vital for Europe's energy future. This report summarizes the potential resource and sets targets for development of the grid network in the Baltic, North, and Irish Seas, the English Channel, and the Gulf of Finland. Currently 11 offshore grids are operational and 21 are being considered.

EWEA. 2011a. The European offshore wind industry key trends and statistics 2010. European Wind Energy Association. 3 pp.

ANNOTATION: This report summarizes the status of the European offshore wind industry at the end of 2010 in terms of number of new turbines connected, wind farms completed, and wind farms under construction as well as predictions for activity in 2011.

EWEA. 2011b. Operational offshore wind farms in Europe, end 2010. European Wind Energy Association. 4 pp.

ANNOTATION: This reference is a table characterizing offshore wind projects that were operational by the end of 2010. Information, by country, is provided on location, capacity, number of turbines, water depth, distance to shore, year the project went on-line, and foundation type.

Exponent. 2001. Hudson Energy Project: Evaluation of Potential Environmental Effects of Proposed HVDC Submarine Cable Systems. Exponent, Inc. pp.

ANNOTATION: Source of data on IRC cable systems

Exponent. 2004. Post-Construction Monitoring: DC Magnetic Fields Associated with the Operation of the Cross-Sound Submarine Cable System and DC and AC Magnetic Fields Associated with the Operation of the Cross-Sound Converter Station and Land Cable System. Exponent, Inc. pp.

ANNOTATION: This is the first project for which detailed post-construction monitoring was performed to confirm pre-construction estimates of magnetic fields from a submarine power cable. The measured values were shown to have close agreement with predicted values.

Exponent Inc. and Hatch Ltd. 2009. Electric and Magnetic Fields (EMF), Considerations and Field Models for the Naikun Offshore Wind Energy Project. Government of British Columbia, British Columbia. 53 pp.

ANNOTATION: The electricity generated by the NaiKun Offshore Wind Energy project, Canada's first off shore wind farm, will be carried over 90-120 km of 33 kV AC cables to an offshore converter station. A portion of the power will be carried from that station on a 50 km, undersea 33 kV AC cable system to Haida Gwaii. The bulk of the power will be converted to DC and carried on a ± 200 kV cable system to an onshore converter station on the mainland of British Columbia. The Environmental Assessment contained in the Application for an Environmental Assessment Certificate includes calculations of the DC magnetic field from the ± 200 kV cable system from an offshore converter added to the geomagnetic field of the earth in two orientations and calculations of AC magnetic fields from 33-kV 60Hz power cables that transfer power from

wind turbines to the converter station and to a distant island. An extensive review of research on potential effects of electric and magnetic fields on the marine environment is included.

Gill, A. B., Y. Huang, I. Gloyne-Phillips, J. Metcalfe, V. Quayle, J. Spencer, and V. Wearmouth. 2009. COWRIE 2.0 Electromagnetic Fields (EMF) Phase 2: EMF-sensitive fish response to EM emissions from sub-sea electricity cables of the type used by the offshore renewable energy industry. COWRIE Ltd. COWRIE-EMF-1-06. 128 pp.

ANNOTATION: A mesocosm study was conducted to determine whether electromagnetically sensitive fish respond to EMFs of the type and magnitude generated by offshore wind farm transmission cables. Three elasmobranch species were studied: The benthic Thornback Ray (*Raja clavata*), the freeswimming Spurdog (*Squalus acanthias*) and benthic Small-spotted Catshark/Lesser-spotted Dogfish (*Scyliorhinus canicula*). Responses were reported for the benthic species, thornback Ray and small-spotted Catshark.

EMF measurements were made at transmission cables of existing wind projects. The North Hoyle windfarm was the first major UK offshore windfarm with a capacity of 90 MW and began operation in 2004. The Burbo Bank windfarm, also with a 90 MW capacity, is located nearby and began operation in 2007. Power is transmitted 9 - 10 km to shore locations over 36kV XLPE armored cables. Gill et al. (2009) reports on measurements of electric and magnetic fields near the underwater cables.

Gradient Corporation. 2006. Sensitivity of marine organisms to undersea electric and magnetic fields. Cape Wind Energy Project DEIS, Appendix 3.7-C Gradient Corporation for Cape Wind Energy Project DEIS, US Department of the Interior, Minerals Management Service, Herndon, VA. 21 pp.

ANNOTATION: This report includes calculations of the magnetic field of low and high voltage cables and a discussion of the potential sensitivity of marine organisms to electric and magnetic fields. Results of a literature review of species sensitive to electric and magnetic fields are reported.

Hoffmann, E., J. Astrup, F. Larsen, S. Munch-Petersen, and J. Støttrup. 2000. Effects of Marine Windfarms on the Distribution of Fish, Shellfish, and Marine Mammals in the Horns Rev Area, Report to Elsamprojekt A/S. Danish Institute for Fisheries Research, Charlottelund, Denmark. 42 pp.

ANNOTATION: The Horns Rev 2 Offshore Wind Farm transmits power from 80 x 2.0 MW turbines from this large offshore windfarm, carried over 33kV AC cables to a step-up transformer for transfer to a substation on the mainland over a 132kV submarine cable. The project included comprehensive environmental monitoring studies, pre- and post-construction. No effects of the windfarm or cables on the behavior of seals, porpoises, or benthic species along the cable route were reported.

Huang, Y. 2005. Electromagnetic Simulations of 135-kV Three-Phase Submarine Power Cables. Center for Marine and Coastal Studies, Ltd. Prepared for Sweden Offshore. 25 pp.

ANNOTATION: This paper reports modeling of the 50-Hz AC magnetic fields and induced electric fields for a representative 138kV three-phase XPLE submarine cable carrying 700 amperes from a windfarm. The work was conducted by Liverpool University as part of the CMACS (2003) COWRIE project³. The objective of the project was to simulate the electromagnetic fields generated by a three-phase cable buried 1m into the seabed in an area of the Baltic Sea where seawater salinity is 10 – 15 PSU. The modeling showed that cable sheaths effectively shield the environment outside the cables from the electric field. Nonetheless, the simulation also demonstrated that electromagnetic fields are present outside the three-phase cable, radiating into both the seabed and seawater. Magnetic fields are generated by the alternating currents in the cable, and there are induced electric fields due to the changing magnetic fields. The maximum magnetic field and induced electric field above the seabed for cables buried 1 m were 0.6 μ T and 80 μ V/m, respectively.

ICES. 2002. IEEE Standard for Safety Levels with Respect to Human Exposure to Electromagnetic Fields, 0-3 kHz - Annex B. Pages 42-43. Ieee International Committee on Electromagnetic Safety on Non-Ionizing Radiation.

ANNOTATION: Annex B provides a model to estimate the induced electric field in an organism with an ellipsoidal shape and homogeneous composition.

IEEE. 1988. IEEE Standard Dictionary of Electrical and Electronics Terms, 4th Ed. The Institute of Electrical and Electronics Engineers, New York.

ANNOTATION: This reference is a dictionary of electrical and electronics terms.

Institute for Sustainable Energy. 2003. Comprehensive Assessment and Report Part II - Environmental Resources and Energy Infrastructure of Long Island Sound. Task Force on Long Island Sound, Institute for Sustainable Energy at Eastern CT State University, with Assistance from Levitan & Associates and Normandeau Associates, Willimantic, CT. 242 pp.

ANNOTATION: The 1385 Line Cable System consists of two 138 kV circuits laid in parallel that traverse approximately 11 miles from the Norwalk Harbor Substation on Manresa Island in Norwalk, CT, across both the seabed of Sheffield Harbor and Sheffield Island, to the Northport Substation in Northport, NY. The 138 kV cable system, which is owned by CL&P in Connecticut and LIPA in New York, was installed in 1969 and commenced operation in 1970. The system consisted of seven separate three-inch-diameter fluid-filled cables, each containing a single hollow core copper conductor surrounded by paper insulation, a lead covering, and outside armoring. To serve as an effective insulator, the paper was impregnated with dielectric fluid

maintained under pressure. Several of the cables were severed or severely damaged by dragging anchors and this system was replaced by newer XLPE cables. See CSC (2002).

Kalmijn, A. 1984. Theory of electromagnetic orientation: a further analysis. Pages 525-564 *in* L. Bolis, R. D. Keynes, and S. H. O. Maddess, editors. *Comparative Physiology of Sensory Systems* Cambridge University Press, Cambridge.

ANNOTATION: This review provides a very clear discussion of the physics underlying potential mechanisms by which elasmobranchs may actively and passively detect magnetic and electric fields.

Koops, F. B. J. 2000. Electric and Magnetic fields in Consequence of Undersea Power Cables. Pages 189-210 *in* *Effects of Electromagnetic Fields on the Living Environment: Proceedings of the International Seminar on Effects of Electromagnetic Field on the Living Environment*.

ANNOTATION: This review focuses on the effects of electric and magnetic fields from undersea DC power cables, with a focus on the European experience.

Kullnick, U. H. 2000. Influences of Electric and Magnetic Fields on Aquatic Ecosystems. Pages 113-132 *in* *Effects of Electromagnetic Fields on the Living Environment: Proceedings of the International Seminar on Effects of Electromagnetic Field on the Living Environment*.

ANNOTATION: This paper provides an overview of electric and magnetic fields from undersea DC power lines on the marine environment. The effects of other technologies including AC power lines of offshore wind power systems are not covered.

Madureira, A., F. Oliveira, and M. P. Donisi3n. 2004. Statistical Study of Power Quality in Wind Farms. Pages 1-5 *in* *International Conference on Renewable Energies and Power Quality*. (ICREPQ'04), Paper No. 318. Barcelona, Spain.

ANNOTATION: This study analyzed three weeks of power quality data from the Sotavento Experimental Wind Farm in Galicia, Spain. The measured indices included all voltage harmonics from 0 to 42nd order, the current, active and reactive power, power factor, voltage unbalance, total harmonic distortion (THD), flicker indexes (Pst and Plt), and wind velocity.

Marin, G., A. See, and B. N. Rinehart. 1998. Cable Intertie Project, Hanes to Skagway, Alaska - Final Technical and Construction Report. Idaho National Engineering and Environmental Laboratory Renewable Energy Products Department and Lockheed Martin Idaho Technologies Company for U.S. Department of Energy, Assistant Secretary for Energy Efficiency and Renewable Energy, Under DOE Idaho Operations Office Grant Agreement 218505, Idaho Falls, ID. 60 pp.

ANNOTATION: The Haines-Scagway submarine cable intertie carries power along a 15 mile, 35kV submarine cable at the bottom of Taiya Inlet from the Goat Lake Hydroelectric Project near Skagway, AL to Haines, AL.

MMS. 2009a. Cape Wind Energy Project, Final Environmental Impact Statement. US Department of the Interior, Minerals Management Service. 800 pp.

ANNOTATION: This is the Final Environmental Impact Statement for the Cape Wind Energy Project. Biological resources in the project area (Nantucket Sound, MA) are characterized and potential impacts to those resources, including impacts from EMFs, from the proposed offshore wind facility are analyzed and discussed.

The proposed project involves collecting electricity generated by 132 wind turbines, each of 3.6 MW capacity. The low-voltage power generated would be converted to 33 kV at a transformer and distributed to an electrical service platform for conversion to 115 kV and transported over two circuits to Yarmouth, MA.

MMS. 2009b. Renewable Energy Program: Long Island Offshore Wind Park. US Department of the Interior, Minerals Management Service. Internet website: <http://www.mms.gov/offshore/alternativeenergy/LIOWP.htm>. Accessed: September 2009.

ANNOTATION: The proposed Long Island Offshore Wind Park will collect electricity at 34.5 kV from a cluster of 40 wind turbines in the Atlantic Ocean off Long Island and transmit the power over a 138kV undersea cable through South Oyster Bay to West Amityville, NY.

NGDC. 2010. Geomagnetism Frequently Asked Questions. National Geophysical Data Center. Internet website: <http://www.ngdc.noaa.gov/geomag/faqgeom.shtml>. Accessed: April, 2010.

ANNOTATION: This NOAA website provides comprehensive data and models to characterize geomagnetic fields.

NOAA. 2010. International Geomagnetic Reference Field. National Oceanic Atmospheric Administration, National Geophysical Data Center. Internet website: http://www.ngdc.noaa.gov/geomag/icons/Obs1999_lg.gif. Accessed: April, 2010.

ANNOTATION: This agency provides comprehensive data and models to characterize geomagnetic fields.

NSCOGI. 2010. The North Seas Countries' Offshore Grid Initiative Memorandum of Understanding. North Seas Countries' Offshore Grid Initiative. 16 pp.

ANNOTATION: North Seas Countries' Offshore Grid Initiative assembled representatives from Belgium, Denmark, France, Germany, Ireland, Luxembourg, the Netherlands, Norway, Sweden, and the United Kingdom to jointly advance development of an integrated energy system throughout the North Sea boundary countries. A key priority is the offshore grid in the Northern Seas. This MOU establishes a commitment to identifying and addressing barriers to grid development at national, regional, and European levels.

NY PSC. 2004. Opinion and Order Adopting Joint Proposal and Granting Certificate of Environmental Compatibility and Public Need for a Transmission Facility from New Jersey to Long Island. State of New York Public Service Commission, Albany, NY. 91 pp.

ANNOTATION: The 23-mile,500kV DC Neptune Regional Transmission System consists of a paper-insulated, mass-impregnated cable and an XLPE insulated return conductor bundled together, which connects a converter station near Sayerville, NJ to another located on the shore of Long Island in North Hempstead, NY.

OSI. 2009. Final Report. Magnetic Intensity Study. Long Island Replacement Cables - Sheffield Harbor and Long Island Sound, Norwalk, Connecticut. Ocean Surveys, Inc. 43 pp.

ANNOTATION: This report summarizes the results of a DC magnetic field intensity study in and around Sheffield Harbor, Norwalk, CT, and in a portion of Long Island Sound. Although the task was part of a monitoring program designed to assess the potential environmental effects of the AC Long Island Power Authority (LIPA)/Connecticut Light and Power Company (CL&P) Long Island Replacement Cable Project ("LIRC" or "Project") which extends from Norwalk, CT to Northport, NY in Long Island Sound, no measurements of the AC magnetic field of the LIRC were made.

Papathanassiou, S. A. and M. Papadopoulos. 2006. Harmonic Analysis in a power system with wind generation. IEEE Trans on Power Delivery 21:2006-2016.

ANNOTATION: This paper describes a case study of the harmonic analysis of a 20x500 kW wind farm proposed to be connected to the medium voltage network of the Greek island of Kefalonia

RSK Ireland Ltd. 2009. EirGrid East West Interconnector Project - Ireland Marine Environmental Report, Nontechnical Summary (Vol 1.) and Main Text (Vol. 2). RSK Group PLC, Dublin, Ireland. 192 pp.

ANNOTATION: The EirGrid East West Interconnector project is a 184 km,500kV DC undersea cable system that connects Rush North Beach, County Dublin in Ireland to Barkby Beach, North

Wales in Britain. A limited discussion of the DC magnetic field from the cable system and potential responses to the DC magnetic field is provided.

Silva, J. M., L. E. Zaffanella, and J. P. Daigle. 2006. EMF Study: Long Island Power Authority (LIPA), Offshore Wind Project. 74 pp.

ANNOTATION: Calculated magnetic fields associated with a 138kV AC undersea cable from a proposed offshore windfarm are presented. Appendix 2 analyzes the effect of the flux shunting effect of cable armouring, which attenuates the magnetic field outside the cable in the marine environment.

Skiles, D. D. 1985. The geomagnetic field: its nature, history, and biological relevance. Pages 223-232 in J. L. Kirschvink, D. S. Jones, and B. J. MacFadden, editors. Magnetite biomineralization and magnetoreception in organisms, a new biomagnetism. Plenum Press, New York and London.

ANNOTATION: This chapter discusses the Earth's magnetic field, including its nature, history, and biological relevance.

Skog, J. E., K. Koreman, B. Pääjärvi, T. Worzyk, and T. Andersröd. 2006. The NORNED HVDC Cable link between a power transmission highway between Norway and the Netherlands, presented at ENERGEX 2006, Stavanger, Norway, June 12-15, 2006. Pages 1-6.

ANNOTATION: The paper describes a bipolar DC cable between Norway and the Netherlands that will be the longest submarine cable yet proposed as of 2007.

Stephenson, D. and K. Bryan. 1992. Large-scale electric and magnetic-fields generated by the oceans. *Journal of Geophysical Research-Oceans* 97:15467-15480.

ANNOTATION: This paper reports on electric and magnetic fields induced by ocean currents. The authors report that magnetic fields from ocean currents are strongest in shallow regions and are on the order of 1 nT.

TPC. 2001. Final Panel Report on Basslink Proposal. Tasmanian Planning Commission. 415 pp.

ANNOTATION: This project was originally proposed as a 400kV bipolar submarine cable but was modified by the developer to a SRC design to address concerns about corrosion and other potential effects.

URS. 2006. Draft Environmental Impact Report for the Proposed Trans Bay Cable Project. URS Corporation, Prepared for the City of Pittsburg, CA. 769 pp.

ANNOTATION: The proposed Trans Bay cable project would involve converting AC to DC power at a proposed converter station in Pittsburg, CA. The DC power would then be transmitted approximately 53 miles through a proposed submarine and buried onshore HVDC cable installed undersea beneath Suisun Bay, the Carquinez Straits, San Pablo Bay, and San Francisco Bay to a proposed converter station in San Francisco, CA. The conclusion of the DEIR was “Potential operations-related impacts on marine organisms associated with electric and magnetic fields and cable heat are also expected to be insignificant.” No calculations of DC magnetic fields or a detailed environmental assessment of DC magnetic field effects are presented.

Vattenfall. 2009. Kentish Farms Offshore Windfarm. Vattenfall Group. Internet website: <http://www.kentishflats.co.uk/index.dsp?area=1374>. Accessed: September 2009.

ANNOTATION: The Kentish Flats Offshore Windfarm consists of 40 turbines each with a maximum output of 4.3 MW located approximately 8.5 km off the north Kent coast. The output of the turbines is carried over cables at 33 kV and the voltage increased to 132 kV for transport to shore. No calculations of AC magnetic fields or assessment of potential effects on marine environment were located.

Voitovich, R. A. and K. P. Kadomskaya. 1997. Influence of the design parameters of high-voltage underwater power cables on the electromagnetic field intensity in an aqueous medium. *Electrical Technology* 2:11-21.

ANNOTATION: This paper modeled the magnetic field from submarine cables as a function of typical current flows and variations in the conductivity of the shield and armour.

Walker, T. I. 2001. Basslink Project Review of Impact of High Voltage Direct Current Sea Cables and Electrodes on Chondrichthyan Fauna and Other Marine Life. Marine and Freshwater Resources Institute Report to NSR Environmental Consultants Pty Ltd, Queenscliff, Victoria. 77 pp.

ANNOTATION: The 400kV,DC Basslink interconnector runs from Loy Yang in Gippsland, Victoria, across Bass Strait to Bell Bay in northern Tasmania. The 290 km undersea cable component of Basslink is the longest of its type in the world and is operated in a monopole configuration with a sea electrode return.

Worzyk, T. 2009. Submarine power cables : design, installation, damages and repair, environmental aspects. Springer, Berlin; London.

ANNOTATION: This book reviews design, installation, maintenance, and environmental effects of undersea power cables. The book focuses on cable engineering topics. Includes a chapter on offshore wind facilities. Potential impacts related to EMFs are briefly reviewed.

Appendix A-2 EMF Impacts

Andrulewicz, E. D., D. Napierska, and Z. Otremba. 2003. The environmental effects of the installation and functioning of the submarine SwePol Link HVDC transmission line: a case study of the Polish marine area of the Baltic Sea. *Journal of Sea Research* 49:337-345.

ANNOTATION: The SwePol Link 245-km \pm 450kV DC cable system crosses the Baltic Sea to connect converter stations in Slupsk, Poland and Karlshamm, Sweden. Andrulewicz et al. (2003) provides calculations of the DC magnetic field and a discussion of environmental monitoring. The paper reports that one year after installation "there had been no significant changes in zoobenthos species composition, abundance or biomass which could have been clearly related to cable installation."

BERR. 2008. Review of cabling techniques and environmental effects applicable to the offshore wind farm industry. Department for Business Enterprise and Regulatory Reform, UK Government. 164 pp.

ANNOTATION: This technical report provides information about the undersea cables and installation techniques used for offshore wind facilities, and associated environmental effects.

Boehlert, G. W., G. R. McMurray, and C. E. Tortorici. 2008. Ecological effects of wave energy development in the Pacific Northwest : a scientific workshop, October 11-12, 2007. U.S. Dept. of Commerce, National Oceanic and Atmospheric Administration, National Marine Fisheries Service, Seattle, Wash. 174 pp.

ANNOTATION: This NOAA/NMFS technical report presents the proceedings from a workshop that addressed ecological effects of wave energy development. "Electromagnetic Effects" was one of five potential impact producing factors covered in "Stressor Breakout Groups" specific to each factor. Key impacts, resources affected, data gaps, and recommended studies or monitoring are covered.

CMACS. 2003. A baseline assessment of electromagnetic fields generated by offshore wind farm cables. University of Liverpool, Centre for Marine and Coastal Studies. Rep. No. COWRIE EMF-01-2002 66. 71 pp.

ANNOTATION: This report was prepared by the Centre for Marine and Coastal Studies at the University of Liverpool, UK, and was commissioned by COWRIE (Collaborative Offshore Wind Research Into The Environment). The report provides a baseline assessment of electromagnetic fields (EMF) generated by offshore wind farm cables. Questions investigated included: (1) The likely EMF emitted from a undersea power cable, (2) methods to measure EMF in the field, (3) mitigation measures to reduce EMF, and (4) and consideration of requirements for the next stage of investigation into the effects of EMF on electrosensitive species.

Department of Energy and Climate Change. 2010. Revised Draft National Policy Statement for Renewable Energy Infrastructure (EN-3). UK Department of Energy and Climate Change, London. 86 pp.

ANNOTATION: The National Policy Statement (NPS) from the DECC (UK) provides the basis for the Infrastructure Planning Commission (IPC) to make decisions on applications for nationally significant renewable energy infrastructure. For offshore wind projects, the NPS provides guidance on the issues that the applicant must address prior to seeking licenses and technical considerations the IPC must consider prior to determining acceptability of an application. The NPS specifies that EMF during operation may be mitigated by burying armored cables more than 1.5 m below the sea bed for both interarray and export cables. The NPS also addresses other specific ecological impact issues.

DOE. 2008. Report to Congress: Potential Environmental Effects of Marine and Hydrokinetic Energy Technologies. Prepared in response to the Energy Independence and Security Act of 2007, Section 633(b). Public review draft. US Department of Energy. 106 pp.

ANNOTATION: This draft report was prepared for Congress by the US Department of Energy (DOE) as required by Section 633(b) of the Energy Independence and Security Act of 2007 (EISA). Potential impacts to biological resources from hydrokinetic energy technologies, including potential impacts related to EMF, are reviewed and discussed. A final report is due to Congress by June 30, 2009.

DOE. 2009. Report to Congress on the Potential Environmental Effects of Marine and Hydrokinetic Energy Technologies. Prepared in response to the Energy Independence and Security Act of 2007, Section 633(b). Final report. US Department of Energy. 143 pp.

ANNOTATION: This report was prepared for Congress by the US Department of Energy (DOE) as required by Section 633(b) of the Energy Independence and Security Act of 2007 (EISA). Potential impacts to biological resources from hydrokinetic energy technologies, including potential impacts related to EMF, are reviewed and discussed. Appendix D specifically discusses effects of EMF.

DONG. 2006. Danish Offshore Wind – Key Environmental Issues. The Danish Energy Authority and The Danish Forest and Nature Agency, DONG Energy, Vattenfall. 144 pp.

ANNOTATION: This report discusses environmental effects related to offshore wind farms in Denmark based on monitoring at Horns Rev and Nysted. The effects of EMFs on fish at Nysted are discussed.

DONG and Vattenfall. 2006. The Danish Offshore Wind Farm Demonstration Project: Horns Rev and Nysted Offshore Wind Farms. Environmental impact assessment and monitoring. Review report 2005. Prepared by DONG Energy and Vattenfall A/S for The Environmental Group of the Danish Offshore Wind Farm Demonstration Projects. 150 pp.

ANNOTATION: Compilation of the results of preliminary impact assessment, baseline and post-construction monitoring of biological resources at the Horns Rev and Nysted offshore wind farms. Effects of EMF emissions on fish were examined at Nysted. Results appeared to show some effects from the cable trace on fish behavior, but did not show a conclusive correlation between these effects and the strength of the electromagnetic field. Recovery of the physical conditions along the cable was not examined and the report suggested that fish behavior could have been a response to incomplete recovery.

Gill, A. B. 2005. Offshore renewable energy: ecological implications of generating electricity in the coastal zone. *JOURNAL OF APPLIED ECOLOGY* 42:605-615.

ANNOTATION: This paper reviews the potential ecological implications of offshore renewable energy development including a discussion of EMF. The current state of knowledge regarding impacts to coastal ecosystems from human activities is reviewed. Potential impacts associated with construction, operation, and decommissioning phases of the various renewable energy technologies are discussed. The implications for benthos, fish, marine mammals, and birds of physical disturbance, noise, electromagnetic forces, and other direct effects are discussed, and indirect ecological effects are reviewed.

Gill, A. B. and M. Bartlett. 2010. Literature review on the potential effects of electromagnetic fields and undersea noise from marine renewable energy developments on Atlantic salmon, sea trout and European eel. Scottish Natural Heritage Commissioned Report No.401. 43 pp.

ANNOTATION: The purpose of this literature review was to evaluate the potential for Atlantic salmon, sea trout, and European eel to be affected by marine wave and tidal power developments, specifically by EMF emissions from undersea cables and from underwater noise generated by the projects. Literature is available that documents that Atlantic salmon and European eel can use the geomagnetic field for orientation and direction finding during migrations. The authors inferred that, depending on location, EMFs from undersea cables and cabling orientation may interact with migrating eels (and possibly salmon), particularly in waters <20m. The biological significance of a response to EMFs could not be determined. All three species are likely to encounter EMF from undersea cables during the adult or early life stage movements through shallow coastal waters adjacent to natal rivers. The authors emphasized that actual responses to EMF fields and their ultimate significance to the species have yet to be determined.

Gill, A. B., I. Gloyne-Phillips, K. J. Neal, and J. A. Kimber. 2005. COWRIE 1.5 Electromagnetic Fields Review: The potential effects of electromagnetic fields generated by sub-sea power cables

associated with offshore wind farm developments on electrically and magnetically sensitive marine organisms - a review. Collaborative Offshore Wind Research into the Environment (COWRIE), Ltd, UK. 128 pp.

ANNOTATION: Results of a literature search and synthesis to assess potential impacts from EMF on marine species in UK marine and estuarine waters are presented here. The authors indicate that there are potential interactions between electromagnetic emissions from windfarm cables and marine organisms including elasmobranchs and other fish, as well as marine mammals. Nine cetaceans and two sea turtles found in UK waters have shown a response to magnetic fields. The authors also state that more data is needed on EMF emissions and their impacts on marine life.

Gill, A. B., Y. Huang, I. Gloyne-Phillips, J. Metcalfe, V. Quayle, J. Spencer, and V. Wearmouth. 2009. COWRIE 2.0 Electromagnetic Fields (EMF) Phase 2: EMF-sensitive fish response to EM emissions from sub-sea electricity cables of the type used by the offshore renewable energy industry. COWRIE Ltd. COWRIE-EMF-1-06. 128 pp.

ANNOTATION: A mesocosm study was conducted to determine whether electromagnetically sensitive fish respond to EMFs of the type and magnitude generated by offshore wind farm transmission cables. Three elasmobranch species were studied: The benthic Thornback Ray (*Raja clavata*), the freeswimming Spurdog (*Squalus acanthias*) and benthic Small-spotted Catshark/Lesser-spotted Dogfish (*Scyliorhinus canicula*). Responses were reported for the benthic species, thornback Ray and small-spotted Catshark.

EMF measurements were made at transmission cables of existing wind projects. The North Hoyle windfarm was the first major UK offshore windfarm with a capacity of 90 MW and began operation in 2004. The Burbo Bank windfarm, also with a 90 MW capacity, is located nearby and began operation in 2007. Power is transmitted 9 - 10 km to shore locations over 36kV XLPE armored cables. Gill et al. (2009) reports on measurements of electric and magnetic fields near the underwater cables.

Gill, A. B. and A. A. Kimber. 2005. The potential for cooperative management of elasmobranchs and offshore renewable energy development in UK waters. *Journal of the Marine Biological Association of the United Kingdom* 85:1075-1081.

ANNOTATION: This paper reviews potential impacts to elasmobranchs in UK waters from offshore renewable energy projects and suggests cooperative management strategies for elasmobranch conservation and offshore renewable energy development (ORED). Impacts related to EMF are reviewed and discussed.

Gill, A. B. and H. Taylor. 2001. The potential effects of electromagnetic fields generated by cabling between offshore wind turbines upon elasmobranch fishes. Countryside Council for Wales. Contract Science Report 488. 60 pp.

ANNOTATION: This report reviews potential impacts to British elasmobranchs from electromagnetic fields generated by undersea power transmission cables for offshore wind projects. The report includes results of literature reviews covering electroreception in elasmobranchs, offshore wind developments in Europe and associated environmental effects, and the biology of British elasmobranchs. The report also presents results of a pilot study, using the Lesser spotted dogfish (*Scyliorhinus canicula*), to compare behavioural responses to electric fields simulating those produced by prey items and by a typical power transmission cable. The authors report an avoidance response (variable among individuals) to electric fields at 10 μ V/cm (simulating cables) and an attraction response to fields at 0.1 μ V/cm, 10cm from the source (simulating prey). The report also includes a discussion of future research priorities.

Gradient Corporation. 2006. Sensitivity of marine organisms to undersea electric and magnetic fields. Cape Wind Energy Project DEIS, Appendix 3.7-C Gradient Corporation for Cape Wind Energy Project DEIS, US Department of the Interior, Minerals Management Service, Herndon, VA. 21 pp.

ANNOTATION: This report includes calculations of the magnetic field of low and high voltage cables and a discussion of the potential sensitivity of marine organisms to electric and magnetic fields. Results of a literature review of species sensitive to electric and magnetic fields are reported.

Hoffmann, E., J. Astrup, F. Larsen, S. Munch-Petersen, and J. Støttrup. 2000. Effects of Marine Windfarms on the Distribution of Fish, Shellfish, and Marine Mammals in the Horns Rev Area, Report to Elsamprojekt A/S. Danish Institute for Fisheries Research, Charlottelund, Denmark. 42 pp.

ANNOTATION: The Horns Rev 2 Offshore Wind Farm transmits power from 80 x 2.0 MW turbines from this large offshore windfarm, carried over 33kV AC cables to a step-up transformer for transfer to a substation on the mainland over a 132kV submarine cable. The project included comprehensive environmental monitoring studies, pre- and post-construction. No effects of the windfarm or cables on the behavior of seals, porpoises, or benthic species along the cable route were reported.

Köller, J. 2006. Offshore wind energy research on environmental impacts. Springer, Berlin; Heidelberg; New York.

ANNOTATION: This book reviews environmental impacts associated with offshore wind facilities. Chapter 14 specifically covers potential impacts to marine species from EMFs. The chapter focuses on magnetic fields with effects of short-term and long-term exposures discussed.

Michel, J. and E. Burkhard. 2007. Workshop to Identify Renewable energy Environmental Information Needs: Workshop Summary. U.S. Department of the Interior, Minerals Management Service, Herndon, VA. MMS OCS Report 2007-057. 50 pp.

ANNOTATION: This report summarizes the proceedings of a workshop held by the Minerals Management Service to identify information gaps related to environmental considerations for offshore renewable energy development. Potential impacts from EMFs was one of the topics covered and a table in this report presents comments on information needs for EMF impacts.

Michel, J., H. Dunagan, C. Boring, E. Healy, W. Evans, J. M. Dean, A. McGillis, and J. Hain. 2007. Worldwide Synthesis and Analysis of Existing Information Regarding Environmental Effects of Renewable energy Uses on the Outer Continental Shelf. U.S. Department of the Interior, Minerals Management Service, Herndon, VA. MMS OCS Report 2007-038. 254 pp.

ANNOTATION: This MMS report presents the results of a comprehensive literature search and synthesis analysis regarding environmental effects of renewable energy uses on the Outer Continental Shelf. From the project summary: “Most available literature was based on assessments or studies of existing or planned offshore wind parks in Europe. There were a few prototype or demonstration projects for wave energy devices and tidal current systems for deployment nearshore, but there were no full-scale installations in operation. While existing literature provided valuable information on the potential magnitude of impacts for environmental resources in the project areas, more information is needed to address environmental assessment of renewable energy projects in the offshore waters of the United States. These information needs are described in detail for the broad resource categories of physical processes, benthic resources, fishery resources, marine mammals, sea turtles, and flying animals (birds, bats, and flying insects) at the end of each section on wind, wave, and ocean current technologies.”

Potential effects of EMFs on marine species are briefly discussed.

MMS. 2007. Programmatic Environmental Impact Statement for Renewable energy Development and Production and Alternative Use of Facilities on the Outer Continental Shelf, Final Environmental Impact Statement. US Department of the Interior, Minerals Management Service. OCS EIS/EA MMS 2007-046. pp.

ANNOTATION: The Final Programmatic Environmental Impact Statement (EIS) for Renewable energy Development and Production and Alternate Use of Facilities on the Outer Continental Shelf (OCS), prepared by MMS. This EIS covers the proposed action and alternatives, an overview of potential renewable energy technologies on the OCS, the affected environment, potential impacts of renewable energy development on the OCS and analysis of potential mitigation measures. Potential impacts from EMF are discussed.

MMS. 2009b. Renewable Energy Program: Long Island Offshore Wind Park. US Department of the Interior, Minerals Management Service. Internet website: <http://www.mms.gov/offshore/alternativeenergy/LIOWP.htm>. Accessed: September 2009.

ANNOTATION: The proposed Long Island Offshore Wind Park will collect electricity at 34.5 kV from a cluster of 40 wind turbines in the Atlantic Ocean off Long Island and transmit the power over a 138kV undersea cable through South Oyster Bay to West Amityville, NY.

Nelson, P., D. Behrens, J. Castle, G. Crawford, R. Gaddam, S. Hackett, J. Largier, D. Lohse, K. Mills, P. Raimondi, M. Robart, W. Sydeman, S. Thompson, and S. Woo. 2008. Developing Wave Energy in Coastal California: Potential Socio-Economic and Environmental Effects. California Energy Commission, PIER Energy-Related Environmental Research Program & California Ocean Protection Council. 166 pp.

ANNOTATION: This report examines the potential environmental and socio-economic impacts from development of wave energy in coastal California. Impacts to biological resources from wave energy facilities are reviewed and discussed. The report was prepared for the California Energy Commission and the California Ocean Protection Council. Potential effects of EMFs are discussed.

NIRAS. 2009. Barrow Offshore Wind Farm. Post Construction Monitoring Report. Year 2. NIRAS Consulting Engineers and Planners A/S. 38 pp.

ANNOTATION: Barrow Offshore wind farm became operational in July 2006. This report documents the results of environmental monitoring from 2007-2008. In-situ measurements of EMF were made at the Burbo Bank and North Hoyle wind farms in Liverpool Bay and were summarized in this report, along with fisheries data, in order to evaluate whether the potential exists to impact fish resources. Because of the similarity of the sedimentary environment between Barrow, Burbo Bank, and North Hoyle, it was determined that EMF emissions would be similar. Measured EMF values, extrapolated to full-power conditions, were sufficiently below 100 $\mu\text{V/m}$ and it was, therefore, concluded that EMF emissions from operation of the Barrow project would not adversely affect fish resources.

Öhman, M. C., P. Sigray, and H. Westerberg. 2007. Offshore windmills and the effects of electromagnetic fields on fish. *Ambio* 36:630-633.

ANNOTATION: This paper reviews potential effects on fish from electromagnetic fields from transmission cables for offshore wind parks. Magnetic fields associated with underwater electrical transmission cables are characterized. Studies investigating behavioral and physiological effects from magnetic fields on fish are reviewed and discussed.

OSPAR. 2008. OSPAR Guidance on Environmental Considerations for Offshore Wind Farm Development. Convention for the Protection of the Marine Environment of the North-East Atlantic. 19 pp.

ANNOTATION: This is a guidance document meant to be used in conjunction with project-area-specific regulatory documents. It provides a summary of key environmental issues associated with offshore wind project development. Among other issues, it specifically identifies, in general, mitigation measures available to minimize effects of EMF emissions.

Petersen, J. K. and T. Malm. 2006. Offshore windmill farms: Threats to or possibilities for the marine environment. *Ambio* 35:75-80.

ANNOTATION: This paper reviews potential impacts (negative and beneficial) from offshore wind park development. Negative impacts associated with physical disturbance, noise, and electromagnetic fields are reviewed and discussed. The authors conclude that the greatest impacts are likely associated with the introduction of artificial reef from wind park structures.

Poléo, A. B. S., H. F. Johannessen, and M. Harboe. 2001. High voltage direct current (HVDC) sea cables and sea electrodes: effects on marine life. Dept. of Biology, University of Oslo, Oslo, Norway. N-0316. 50 pp.

ANNOTATION: This report reviews effects to marine species from high voltage direct current (HVDC) sea cables and sea electrodes

Valberg, P. A. 2005. Memorandum addressing electric and magnetic field (EMF) questions. Draft. Cape Wind Energy Project Nantucket Sound. 17 pp.

ANNOTATION: This memorandum is the response to questions about impacts from EMFs that were posed on the Draft Environmental Impact Statement and Draft Environmental Impact Report (DEIS/DEIR, Nov. 2004) for the Cape Wind Energy Project. A literature review and table compiling sensitivity thresholds and effects is included.

Walker, R. and A. Judd. 2010. Strategic Review of Offshore Wind Farm Monitoring Data Associated with FEPA Licence Conditions. Cefas Environment and Ecosystems Division. Department for Environment, Food and Rural Affairs; Centre for Environment, Fisheries and Aquaculture Science. 42 pp.

ANNOTATION: This report reviewed the results of monitoring studies for ten wind farms (five operational and five under construction) in English and Welsh waters. Monitoring results are summarized and compared to license requirements to make recommendations whether monitoring goals have been met or need further study. One important finding was that the purpose of certain monitoring requirements was not clearly articulated in the license conditions,

resulting in data insufficient to address the specific issue. Examination of the potential effects of EMF emissions was required for two (North Hoyle and Barrow) projects because of the presence of elasmobranchs in the area. Authors concluded that fish sampling at North Hoyle was insufficient to confirm or disprove the conclusion of nil effect reached in the environmental impact assessment. For Barrow, the authors concluded that EMF emissions could be sufficiently characterized by measurements taken at Burbo Bank but the greater abundance of elasmobranchs at the wind farm during operation compared to baseline needed further investigation.

Walker, T. I. 2001. Basslink Project Review of Impact of High Voltage Direct Current Sea Cables and Electrodes on Chondrichthyan Fauna and Other Marine Life. Marine and Freshwater Resources Institute Report to NSR Environmental Consultants Pty Ltd, Queenscliff, Victoria. 77 pp.

ANNOTATION: The 400kV,DC Basslink interconnector runs from Loy Yang in Gippsland, Victoria, across Bass Strait to Bell Bay in northern Tasmania. The 290 km undersea cable component of Basslink is the longest of its type in the world and is operated in a monopole configuration with a sea electrode return.

Westerberg, H. 2000. Effect of HVDC cables on eel orientation. Pages 70-76 in *Technische Eingriffe in marine Lebensraume*. Bundesamtes für Naturschutz, Germany.

ANNOTATION: This paper summarizes results from a study on the effects of HVDC cable on European eel (*Anguilla anguilla*) migration. Several individuals veered while passing over an electrified cable in a manner consistent with a response to the cable's magnetic field. Overall, eels were not impeded from crossing the cable, and the author concluded "There is no indication that a cable constitutes a permanent obstacle for migration, neither for the adult eel nor for elvers."

Worzyk, T. 2009. Submarine power cables : design, installation, damages and repair, environmental aspects. Springer, Berlin; London.

ANNOTATION: This book reviews design, installation, maintenance, and environmental effects of undersea power cables. The book focuses on cable engineering topics. Includes a chapter on offshore wind facilities. Potential impacts related to EMFs are briefly reviewed.

Appendix A-3 General Electro – or Magnetosensitivity

Adair, R. K. 1991. Constraints on biological effects of weak extremely-low-frequency electromagnetic fields. *Physical Review A* 43:1039-1048.

ANNOTATION: This paper discusses biological effects of weak EMFs. This reference is not directly relevant to identifying species in US waters with potential sensitivity to EMFs, or to understanding potential impacts, though it may provide some additional supporting information.

Adair, R. K. 1992. Constraints on biological effects of weak extremely-low-frequency electromagnetic-fields - Reply. *Physical Review A* 46:2185-2187.

ANNOTATION: Reply to comments on Adair (1992), which discusses biological effects of weak EMFs. This reference is not directly relevant to identifying species in US waters with potential sensitivity to EMFs, or to understanding potential impacts, though it may provide some additional supporting information.

Adair, R. K. 1994. Constraints of thermal noise on the effects of weak 60-Hz magnetic fields acting on biological magnetite. *Proceedings of the National Academy of Sciences of the United States of America* 91:2925-2929.

ANNOTATION: This paper describes the physical constraints on AC magnetic fields with intensities less than 5 μ T to affect cells via a magnetite-based sensor because of energy transfer and random thermal motion considerations.

Akesson, S. and A. Hedenstrom. 2007. How migrants get there: Migratory performance and orientation. *Bioscience* 57:123-133.

ANNOTATION: Review of migration, orientation and navigation in animals, including discussion of the use of the geomagnetic field by sea turtles. Migration in green sea Turtle, bluefin tuna, white shark, and elephant seal are discussed.

Atema, J. 1988. Sensory biology of aquatic animals : [International Conference on the Sensory Biology of Aquatic Animals, held June 24 - 28, 1985 at the Mote Marine Lab. in Sarasota, Florida]. Springer, New York ;Berlin [u.a.].

ANNOTATION: Conference proceedings with papers given at the Sensory Biology of Aquatic Animals International Conference held June 24-28, 1985, at the Mote Marine Laboratory in Sarasota, Fla.

Barnes, F. S. 2007. Handbook of biological effects of electromagnetic fields. Bioengineering and biophysical aspects of electromagnetic fields. CRC/Taylor & Francis, Boca Raton, FL.

ANNOTATION: This is Volume I (of two) of the third edition of a popular reference book on effects of EMFs. Volume I focuses on bioengineering and biophysical aspects of electromagnetic fields. Topics including environmental sources of EMFs, endogenous sources of electric fields in animals, magnetic properties of biological material, and computational techniques and modeling are covered. Volume II (not selected for this project) focuses on human health and medical aspects related to EMFs.

Bastian, J. 1994. Electrosensory organisms. *Physics Today* 47:30-37.

ANNOTATION: This review discusses electrosensitivity in aquatic animals. Electroreceptor organs are discussed along with electric organ discharge, electric communication, as well as passive and active electrolocation. The review discusses freshwater electric fish but also touches on elasmobranchs.

Bolis, L., R. D. Keynes, and S. H. P. Maddrell. 1984. Comparative physiology of sensory systems. *in* International Conference on Comparative Physiology. Cambridge University Press, Cambridge [Cambridgeshire]; New York.

ANNOTATION: Conference proceedings (International Conference on Comparative Physiology) including a section of papers on sensory systems for electric and magnetic fields.

Bullock, T. H. 1999. The future of research on electroreception and electrocommunication. *Journal of Experimental Biology* 202:1455-1458.

ANNOTATION: This editorial considers the future of research on electroreception and electrocommunication. The author predicts that additional taxa with capabilities to sense electric fields will be discovered and speculates about which groups are most likely to include electroreceptive species. The author discusses that little research has been done to investigate electroreception in invertebrates and mentions molluscs, arthropods, and annelids as potential candidate groups for future review. Much of the paper focuses on fish species. The author questions the role of weak electric organ discharges by electric fish and identifies this as an area in need of further research. One marine species mentioned in this discussion is the stargazer, a marine teleost in the family Uranoscopidae, reported as an electric species by Pickens and McFarland (1964).

Bullock, T. H., D. A. Bodznick, and R. G. Northcutt. 1983. The phylogenetic distribution of electroreception - evidence for convergent evolution of a primitive vertebrate sense modality. *Brain Research Reviews* 6:25-46.

ANNOTATION: This review discusses phylogenetic relationships among organisms capable of electroreception and the evolution of the electric sense. Electroreception is well developed in Petromyzoniformes and in all other non-teleost fishes except Holostei, and probably Myxiniiformes. "Thus Elasmobranchia, Holocephala, Dipneusti, Crossopterygii, Polypteriformes and Chondrostei have the physiological and anatomical specializations in a common form consistent with a single origin in primitive vertebrates." However, the sense was lost in ancestors of holostean and teleostean fishes, then re-immersed in four groups: Siluriformes, Gymnotiformes, Xenomystinae, and Mormyriiformes. Thus, the authors contend that evidence for convergent evolution exists.

Bullock, T. H., R. G. Northcutt, and D. A. Bodznick. 1982. Evolution of electroreception. *Trends in Neurosciences* 5:50-53.

ANNOTATION: This review paper discusses the taxonomic distribution of electroreception and speculates about the evolution of this sense.

Collin, S. P. and N. J. Marshall. 2003. *Sensory processing in aquatic environments*. Springer, New York.

ANNOTATION: This book covers a wide range of topics pertaining to electroreception and magnetoreception in aquatic organisms. This is an update of the 1988 volume of the same name. Topics ranging from navigation and orientation, communication, prey detection, and the coevolution of signal and sense are covered.

Collin, S. P. and D. Whitehead. 2004. The functional roles of passive electroreception in non-electric fishes. *Animal Biology* 54:1-25.

ANNOTATION: This review discusses passive electroreception in elasmobranchs and other fishes. Functional roles of electroreception including prey detection, identification of predators and conspecifics, and the role of electroreception in social behavior are discussed. A case study of electroreception in the omnihaline bull shark, *Carcharhinus leucas*, is presented. Various theories regarding geomagnetic orientation in fishes are also discussed.

Francis, J. T., B. J. Gluckman, and S. J. Schiff. 2003. Sensitivity of neurons to weak electric fields. *Journal of Neuroscience* 23:7255-7261.

ANNOTATION: This study reports on the sensitivity threshold of nerve cells to weak electric fields. This reference is not directly relevant to identifying species in US waters with potential sensitivity to EMFs, or to understanding potential impacts, though it may provide some additional supporting information.

Frankel, R. B. 1984. Magnetic guidance of organisms. *Annual Review of Biophysics and Bioengineering* 13:85-103.

ANNOTATION: A general review of magnetic guidance in organism. Minimal information specific to marine species.

Gould, J. L. 1984. Magnetic-field sensitivity in animals. *Annual Review of Physiology* 46:585-598.

ANNOTATION: Review of the response of many species to DC magnetic fields with particular reference to magnetite. Good overview of the earth's magnetic field and the types of information it contains.

Gould, J. L. 1998. Sensory bases of navigation. *Current Biology* 8:R731-R738.

ANNOTATION: This review provides a good description of the magnetic compass sense in animals. Mechanisms for magnetic compasses are discussed (magnetite crystals, induction, paramagnetic interactions between short-wavelength light and visual pigments). The author states that "most if not all long range maps probably depend on magnetite. Magnetite based map senses are used to measure only latitude in some species, but provide the distance and direction of the goal in others." The use of induction for navigation in elasmobranchs is discussed, and the author states that no evidence for induction-based detection by animals other than elasmobranchs has been reported.

Gould, J. L. 2004. Animal navigation. *Current Biology* 14:R221-R224.

ANNOTATION: This review provides a generic overview of mechanisms underlying animal navigation, including magnetoreception. The author points out that migrating animals are typically equipped with multiple alternative strategies for navigation, between which they switch depending on which is providing the most reliable information.

Gould, J. L. 2008. Animal navigation: The evolution of magnetic orientation. *Current Biology* 18:R482-R484.

ANNOTATION: Generic overview of mechanisms underlying animal navigation through magnetoreception, with a minor mention of elasmobranch electrosensitivity.

Hofmann, M. H. and L. A. Wilkens. 2005. Temporal analysis of moving dc electric fields in aquatic media. *Physical Biology* 2:23-28.

ANNOTATION: This paper reports on electric signals in the natural environment and how those signals are perceived and processed by electrosensitive organisms. The study specifically addresses processing of dc electric fields. The authors discuss that electroreceptors are not sensitive to pure dc fields but that pure dc fields are rare in natural situations since the relative movement between source and signal transforms these fields into time varying signals. The paper illustrates how distance to the source of a dc electric field is perceived by electroreceptive organisms moving through the field.

Jakli, A., J. Harden, C. Notz, and C. Bailey. 2008. Piezoelectricity of phospholipids: a possible mechanism for mechanoreception and magnetoreception in biology. *Liquid Crystals* 35:395-400.

ANNOTATION: This paper reports that phospholipids, the main constituents of cell membranes, are piezoelectric. The authors discuss the piezoelectricity of phospholipids as a possible mechanism for magnetoreception.

Johnsen, S. and K. J. Lohmann. 2005. The physics and neurobiology of magnetoreception. *Nature Reviews Neuroscience* 6:703-712.

ANNOTATION: This review summarizes the physics and characteristics of DC magnetic fields in relation to three main hypotheses as to the ability of marine and other species to detect magnetic fields. The authors conclude “despite recent progress, primary magnetoreceptors have not been identified with certainty in any animal, and the mode or modes of transduction for the magnetic sense therefore remain unknown.”

Johnsen, S. and K. J. Lohmann. 2008. Magnetoreception in animals. *Physics Today* 61:29-35.

ANNOTATION: An excellent non-technical overview of mechanisms, including that of elasmobranchs. It states that elasmobranchs are generally incapable of responding strictly to DC stimuli.

Kalmijn, A. J. 1974. The detection of electric fields from inanimate and animate sources other than electric organs. Pages 147-200 *in* A. Fessard, editor. *Handbook of Sensory Physiology* (Vol. 3). Springer-Verlag, New York.

ANNOTATION: This book chapter describes the sources of electric fields that occur in the ocean, including those of physical, electrochemical and biological origins. Described and modeled are the physical processes involved in the induction of electric currents by the movement of streaming water currents and swimming fish through the earth’s magnetic field. Responses of marine and freshwater animals to weak electric fields are reviewed, with particular focus on information known on marine sharks and rays at that time. The varied responses of ampullary receptors to mechanical, thermal, chemical and electrical stimuli are reviewed. The biological significance of the electric sensitivity in sharks and rays is stated to involve detection

of prey but may also involve detection of electric fields via magnetic induction. Receptor responses in relation to natural stimuli are presented.

Kalmijn, A. J. 1981. Biophysics of geomagnetic field detection. *Ieee Transactions on Magnetics* 17:1113-1124.

ANNOTATION: The author provides a general review of the geomagnetic orientation of animals in the earth's magnetic field. This paper presents equations and models of how the movement of sharks and mud bacteria result in their orientations relative to the earth's magnetic field. Detailed physical models and empirical data on shark and rays are provided. These are compared with the movement of bacteria that swim along magnetic field lines via passive dipole alignment.

Kalmijn, A. J. 1988. Detection of weak electric fields. Pages 151-186 *in* J. Atema, R. R. Fay, A. N. Popper, and W. N. Tavolga, editors. *Sensory Biology of Aquatic Animals*. Springer-Verlag, New York.

ANNOTATION: This book chapter reviews the detection of weak electric fields.

Kalmijn, A. J. 2000a. Detection and biological significance of electric and magnetic fields in microorganisms and fish. . Pages 97-112 *in* M. Rüdiger, J. H. Bernhardt, and M. H. Repacholi, editors. *Effects of Electromagnetic Fields on the Living Environment*, München, Germany.

ANNOTATION: This review considers the detection of electric and magnetic fields by certain marine organisms and the electric and magnetic fields produced by underwater power cables. The review reports that DC electric fields are induced by tidal currents in the range of 0.5 to 50 $\mu\text{V}/\text{m}$ and magnetic fields induce electric fields of 1 to 10 $\mu\text{V}/\text{m}$ but may reach 1 mV/m during electric storms.

Kalmijn, A. J., I. F. Gonzalez, and M. C. McClune. 2002. The physical nature of life. *Journal of Physiology-Paris* 96:355-362.

ANNOTATION: This review discusses electro- and magnetoreception in elasmobranchs. Mechanisms and physical aspects of these senses are discussed including motional-electric principles and Einstein's special theory of relativity.

Kingsford, M. J., J. M. Leis, A. Shanks, K. C. Lindeman, S. G. Morgan, and J. Pineda. 2002. Sensory environments, larval abilities and local self-recruitment. *Bulletin of Marine Science* 70:309-340.

ANNOTATION: This important review discusses the use of multiple cues that influence the orientation and navigational behavior of marine organisms over short distances, centimeter to meter, and over broader geographical areas, tens of meters to tens of kilometers. The use of magnetic and electrical fields by a variety of marine species and various life stages is discussed. The authors state that there is currently no information on the ability of larval stages of marine species to detect magnetic fields. It is also discussed that the only marine species known to detect electrical fields are elasmobranchs and some marine catfishes (Order Siluriformes); no marine species with pelagic larval stages has been reported to detect electrical fields.

Kirschvink, J. L. 1983. Biomagnetic geomagnetism. *Reviews of Geophysics* 21:672-675.

ANNOTATION: This review summarized the potential relationship between the DC magnetic field, magnetite and animal behaviors.

Kirschvink, J. L. 1989. Magnetite biomineralization and geomagnetic sensitivity in higher animals - an update and recommendations for future study. *Bioelectromagnetics* 10:239-259.

ANNOTATION: This review discusses magnetite mechanisms of magnetic field detection and reevaluates experiments with elasmobranch fish to test their sensory capabilities to detect DC magnetic fields.

Kirschvink, J. L. 1992. Constraints on biological effects of weak extremely-low-frequency electromagnetic-fields - comment. *Physical Review A* 46:2178-2184.

ANNOTATION: While no specific discussion of marine species, Kirschvink argues that the view of Adair (1991) that weak ELF fields would not affect cell biology is too limiting and gives the example of the response of the honeybee to DC magnetic fields.

Kirschvink, J. L. 1997. Magnetoreception: homing in on vertebrates. *Nature* 390:339-340.

ANNOTATION: This commentary is related to Walker et al (1997).

Kirschvink, J. L. and J. L. Gould. 1981. Biogenic magnetite as a basis for magnetic-field detection in animals. *Biosystems* 13:181-201.

ANNOTATION: This review discusses the use of biogenic magnetite to detect the direction and intensity of the earth's magnetic field. Organisms discussed range from bacteria to vertebrates. Topics discussed range from the biosynthesis of magnetite and its structural and physical properties, to assays used for identification of magnetite particles in organisms, to mechanisms for magnetic field detection.

Kirschvink, J. L., D. S. Jones, and B. J. MacFadden. 1985. Magnetite biomineralization and magnetoreception in organisms : a new biomagnetism. Plenum Press, New York.

ANNOTATION: This 682 page volume covers magnetoreception via biological magnetite in a wide range of organisms. Includes detailed information about the Earth's magnetic field.

Kirschvink, J. L. and M. M. Walker. 1985. Particle-size considerations for magnetite-based magnetoreceptors. Pages 243-254 *in* J. L. Kirschvink, D. S. Jones, and B. J. MacFadden, editors. Magnetite biomineralization and magnetoreception in organisms, a new biomagnetism. Plenum Press, London.

ANNOTATION: A theoretical analysis that indicates that the total magnetic moment of an organelle could be used to discriminate compass and intensity functions in a putative magnetoreceptor. This paper presents physics arguments that support the possible existence of a magnetite based receptor in biological organisms. This is discussed in relation to observed responses to magnetic stimuli in bacteria, bees and fish.

Kirschvink, J. L., M. M. Walker, and C. E. Diebel. 2001. Magnetite-based magnetoreception. *Current Opinion in Neurobiology* 11:462-467.

ANNOTATION: This review discusses evidence and mechanisms for magnetite-based magnetoreception in organisms ranging from bacteria to vertebrates. The evolution of the magnetic sense and its application for homing, orientation, and navigation is also discussed. The authors argue that magnetite crystals are the basis for magnetoreception in all organisms with this capability, including elasmobranchs.

Kobayashi, A. and J. L. Kirschvink. 1995. Magnetoreception and electromagnetic field effects: Sensory perception of the geomagnetic field in animals and humans. Pages 367-394 *in* M. Blank, editor. *Electromagnetic Fields - Biological Interactions and Mechanisms*.

ANNOTATION: This chapter reviews research on magnetoreception in living organisms and the use of geomagnetic field cues for orientation and navigation. A range of organisms from bacteria to yellowfin tuna are covered.

Lohmann, K. J. 1993. Magnetic compass orientation. *Nature* 362:703-703.

ANNOTATION: This commentary points out that light is not necessary for magnetic compass orientation of turtles and fish and mammals.

Lohmann, K. J. and S. Johnsen. 2000. The neurobiology of magnetoreception in vertebrate animals. *Trends in Neurosciences* 23:153-159.

ANNOTATION: Behavioral evidence has demonstrated that diverse groups of animals can detect the earth's magnetic field and use this cue for orientation. The physiological mechanisms to explain this ability are poorly understood. This review discusses three major hypotheses for magnetic field detection. With regard to electro-sensitive marine fish that might sense the geomagnetic field through electromagnetic induction, the authors conclude that definitive evidence that such fish actually do so has not yet been obtained. The authors also comment that primary magneto-receptors have not yet been identified unambiguously in any animal.

Lohmann, K. J. and C. M. F. Lohmann. 2006. Sea turtles, lobsters, and oceanic magnetic maps. *Marine and Freshwater Behaviour and Physiology* 39:49-64.

ANNOTATION: This review discusses the author's research on how marine animals, such as sea turtles and spiny lobsters, may use magnetic positional information.

Lohmann, K. J., C. M. F. Lohmann, and C. S. Endres. 2008c. The sensory ecology of ocean navigation. *Journal of Experimental Biology* 211:1719-1728.

ANNOTATION: This review paper summarizes the most recent information on underwater navigation including information on magnetic maps, compasses, and navigation using chemical cues, geomagnetic anomalies, hydrodynamic cues (wave direction and ocean currents), and other cues. Hatchling loggerhead turtles can detect both magnetic inclination and field intensity which implies that young turtles have a "magnetic map". Older turtles have the ability to learn the magnetic topography of the areas they inhabit, and incorporate this information into magnetic maps that can be used to navigate to specific goal locations.

New, J. G. and T. C. Tricas. 1997. Electroreceptors and Magnetoreceptors: Morphology and Function. Pages 741-758 *in* N. Sperlakis, editor. *Cell Physiology Source Book*, 2nd ed. Academic Press, San Diego.

ANNOTATION: This book chapter reviews the morphology and function of electroreceptors and magnetoreceptors.

Pals, N. and A. A. C. Schoenhage. 1979. Marine electric fields and fish orientation. *Journal De Physiologie* 75:349-353.

ANNOTATION: This paper describes methods for measurements of DC electric fields in the sea and discusses the possible relevance of local and regional electric fields to electrosensitive fishes.

Peters, R. C., L. B. M. Eeuwes, and F. Bretschneider. 2007. On the electro-detection threshold of aquatic vertebrates with ampullary or mucous gland electroreceptor organs. *Biological Reviews* 82:361-373.

ANNOTATION: This paper reviews and reinterprets results of research on the electric sense in aquatic organisms with ampullary organs. The authors report that the lower detection limit for marine fish is 1 nV/cm (with angular movements) to 20 nV/cm. The importance of angular movements for stimulation of the ampullary system is discussed. Differences in electroreception between benthic and pelagic fish species and between marine and limnic species are discussed.

Presti, D. and P. J. D. 1980. Ferromagnetic coupling to muscle receptors as a basis for geomagnetic field sensitivity in animals. *Nature* 285:99-101.

ANNOTATION: This study reported the detection of magnetic material in the neck musculature of pigeons and migratory white-crowned sparrows. The authors suggest that a magnetic field detector in these birds may be located in the spindles of muscles. They sought to resolve several inconsistencies found in previous studies that involved conditioning immobile pigeons and other experiments with mobile pigeons.

Semm, P. and C. Demaine. 1986. Neurophysiological properties of magnetic cells in the pigeon's visual system. *J. Comp. Physiol.* 159:619-625.

ANNOTATION: This study recorded discharges from single neurons associated with the visual system in the brain of the pigeon. Cells recorded in the basal optic root showed sensitivity to applied magnetic fields when the eyes were illuminated by different wavelengths of light. Neurons sensitive to magnetic stimulus direction in the horizontal plane were identified within the optic tectum. They conclude that magnetic information may be encoded by neurons associated with the pigeon's visual system.

Semm, P., D. Nohr, C. Demaine, and W. Wiltschko. 1984. Neural basis of the magnetic compass: interactions of visual, magnetic and vestibular inputs in the pigeon's brain. *Journal of Comparative Physiology A* 155:283-288.

ANNOTATION: This laboratory study recorded neural discharge activity of single neurons in the basal optic root, vestibular nuclei and vestibule-cerebellum in the pigeon brain during magnetic stimulation. Neurons in the vestibular regions responded only when the pigeon was moved out of the horizontal plane of the applied field. Neurons in the basal optic root responded weakly to changes in direction of the applied magnetic field. The authors conclude that magnetic information may be conveyed from the visual to the vestibular system that is involved in coordination of movements of the animal.

Skiles, D. D. 1985. The geomagnetic field: its nature, history, and biological relevance. Pages 223-232 in J. L. Kirschvink, D. S. Jones, and B. J. MacFadden, editors. Magnetite biomineralization and magnetoreception in organisms, a new biomagnetism. Plenum Press, New York and London.

ANNOTATION: This chapter discusses the Earth's magnetic field, including its nature, history, and biological relevance.

Tenforde, T. S. 1989. Electroreception and magnetoreception in simple and complex organisms. *Bioelectromagnetics* 10:215-221.

ANNOTATION: This review provides a brief summary of mechanisms for electroreception and magnetoreception in organisms ranging from bacteria to vertebrates. This is a prologue to three reviews of magnetoreception in this same issue of *Bioelectromagnetics*: (1) Frankel and Blakemore 1989; (2) Kirschvink 1989; and (3) Walker and Bitterman 1989 (on honeybees; not selected for the MMS database).

Valberg, P. A., R. Kavet, and C. N. Rafferty. 1997. Can low-level 50/60 Hz electric and magnetic fields cause biological effects? *Radiation Research* 148:2-21.

ANNOTATION: This review considers a variety of physics based interactions of electric and magnetic fields with cells.

Walker, M. M. 2008. A model for encoding of magnetic field intensity by magnetite-based magnetoreceptor cells. *Journal of Theoretical Biology* 250:85-91.

ANNOTATION: The author proposes a model in which the magnetoreceptor of birds and fish is based upon biological magnetite.

Walker, M. M., T. E. Dennis, and J. L. Kirschvink. 2002. The magnetic sense and its use in long-distance navigation by animals. *Current Opinion in Neurobiology* 12:735-744.

ANNOTATION: This review paper summarizes representative data and reports relating geomagnetic fields to long distance navigation. It also presents a model to explain these observations.

Walker, M. M., C. E. Diebel, and J. L. Kirschvink. 2007. Sensory systems neuroscience. Pages 335-374 in T. J. Hara and B. Zielinski, editors. *Sensory systems neuroscience: Fish Physiology*, v. 25. Elsevier Academic Press, Amsterdam, Netherlands; Boston, MA.

ANNOTATION: This book chapter reviews magnetoreception in fish. Topics range from an overview of the earth's magnetic field to mechanisms for magnetoreception, anatomical structures, neuroanatomy and neural responses, to use of the magnetic sense for navigation and a discussion of behavioral aspects.

Weaver, J. C. 2002. Understanding conditions for which biological effects of nonionizing electromagnetic fields can be expected. *Bioelectrochemistry* 56:207-209.

ANNOTATION: This paper presents a model to be used in the evaluation of constraints on a magnetic field detection mechanism taking into account chemical reactions and stochastic noise and temperature variation.

Weaver, J. C., T. E. Vaughan, and R. D. Astumian. 2000. Biological sensing of small field differences by magnetically sensitive chemical reactions. *Nature* 405:707-709.

ANNOTATION: This article discusses the importance of multiple cells for the detection of magnetic fields by elasmobranch fish and other species. The authors conclude that a highly sensitive, chemically based magnetic sense is a plausible mechanism for magnetoreception.

Weaver, J. C., T. E. Vaughan, and G. T. Martin. 1999. Biological effects due to weak electric and magnetic fields: The temperature variation threshold. *Biophysical Journal* 76:3026-3030.

ANNOTATION: The authors point out that the detection of weak fields is compromised by additional electrical noise associated with realistic temperature variations during long exposures, a factor not considered in previous theoretical analyses of weak field effects. The authors further note that in vitro conditions are artificially quiet, and may allow the detection of weak responses not seen with in vivo testing.

Wiltschko, R. and W. Wiltschko. 1995. *Magnetic orientation in animals*. Springer, Berlin; New York.

ANNOTATION: This book reviews magnetic orientation in animals including terrestrial and aquatic species. Topics range from mechanisms for magnetoreception to behavioral aspects. Marine groups covered include turtles, fish, and invertebrates.

Wiltschko, R. and W. Wiltschko. 2006. Magnetoreception. *Bioessays* 28:157-168.

ANNOTATION: This review discusses mechanisms for magnetoreception in animals. Magnetite-based mechanisms and radical pair processes involving photopigments are discussed. The review focuses on birds and indicates that mechanisms of magnetoreception in other animals are not well understood.

Appendix A-4 Elasmobranchs – Electric Sense

Adair, R. K. 2001. Simple neural networks for the amplification and utilization of small changes in neuron firing rates. *Proceedings of the National Academy of Sciences of the United States of America* 98:7253-7258.

ANNOTATION: This paper discusses models for neural networks to explain elasmobranch capabilities to detect weak electric fields. Application of these models to other sensory systems, including magnetoreception, is discussed. This reference is not directly relevant to identifying species in US waters with potential sensitivity to EMFs, or to understanding potential impacts, though it may provide some additional supporting information.

Adair, R. K., R. D. Astumian, and J. C. Weaver. 1998. Detection of weak electric fields by sharks, rays, and skates. *Chaos* 8:576-587.

ANNOTATION: The authors discuss the ability of elasmobranchs to detect weak electric fields and their analysis suggests that neurons responding to the electric field involve voltage gated transmembrane proteins – calcium channels.

Akoev, G. N., V. D. Avelev, and P. G. Semenjkov. 1995. Reception of low-intensity millimeter-wave electromagnetic-radiation by the electroreceptors in skates. *Neuroscience* 66:15-17.

ANNOTATION: This reference appears to not be primarily relevant to identifying species in US waters with potential sensitivity to EMFs, or to understanding potential impacts. Nonetheless, it may provide useful supporting information, and has therefore been included in the database.

Akoev, G. N., B. Ilyinski, and P. M. Zadan. 1976. Responses of electroreceptors (ampullae of Lorenzini) of skates to electric and magnetic fields. *Journal of Comparative Physiology A* 106:127-136.

ANNOTATION: This study was conducted on two species of skates and recorded neuron impulses from single axons in the electrosensory nerve that conveys information from the ampullae of Lorenzini to the brain. Neurons responded to both applied electric and magnetic field stimuli. The ampullary receptors responded to changing magnetic stimuli at a rate of change between 0.8 and 20 Gs/sec, but did not sustain the response under a constant magnetic stimulus. Responses to magnetic stimulation were dependent upon ampullary canal length and stimulus direction. This study provides physiological evidence that the ampullary electrosensory system can detect and encode information about magnetic stimuli.

Akoev, G. N., N. O. Volpe, and G. G. Zhadan. 1980. Analysis of effects of chemical and thermal stimuli on the ampullae of lorenzini of the skates. *Comparative Biochemistry and Physiology A-Physiology* 65:193-201.

ANNOTATION: This reference appears to not be primarily relevant to identifying species in US waters with potential sensitivity to EMFs, or to understanding potential impacts. Nonetheless, it may provide useful supporting information, and has therefore been included in the database.

Andrianov, G. N., H. R. Brown, and B. Ilyinski. 1974. Responses of central neurons to electrical and magnetic stimuli of the ampullae of Lorenzini in the black sea skate. *Journal of Comparative Physiology A* 93:287-299.

ANNOTATION: This study investigated the response of neurons in the brain of a skate to electric and magnetic stimuli. Evoked potentials showed marked phasic responses to excitatory and inhibitory stimuli. They were sensitive to stimulus polarity. Four main patterns of responses to electric stimuli were identified. Neurons responded to changing magnetic fields, were direction dependent, were sensitive to the rate of change of the field and showed a response threshold of 2 Gs/sec. Neurons did not respond to a constant magnetic field stimulus. The authors conclude that perception of the earth's magnetic field by the skate is possible.

Andrianov, Y. N., G. R. Broun, O. B. Ilinskii, and V. M. Muraveiko. 1983. Electrophysiological study of central projections of ampullae of Lorenzini in skates. *Neurophysiology* 15:451-457.

ANNOTATION: This reference appears to not be primarily relevant to identifying species in US waters with potential sensitivity to EMFs, or to understanding potential impacts. Nonetheless, it may provide useful supporting information, and has therefore been included in the database. Study in Russian with no English translation.

Andrianov, Y. N., G. R. Broun, O. B. Ilinskii, and V. M. Muraveiko. 1984. Frequency-characteristics of skate electroreceptive central neurons responding to electrical and magnetic stimulation. *Neurophysiology* 16:364-369.

ANNOTATION: This reference appears to not be primarily relevant to identifying species in US waters with potential sensitivity to EMFs, or to understanding potential impacts. Nonetheless, it may provide useful supporting information, and has therefore been included in the database.

Bedore, C. and S. M. Kajiura. 2009. Electrosensitivity and Pore Distribution in the Cownose Ray (*Rhinoptera bonasus*). Poster presented at the 2009 Joint Meeting of Ichthyologists and Herpetologists - Portland, Oregon, 22-27 July 2009.

ANNOTATION: This study investigated pore distribution and electrosensitivity in the cownose ray (*Rhinoptera bonasus*) as compared to the Atlantic stingray (*Dasyatis sabina*). The authors hypothesized that the unique head morphology of the cownose ray might confer an electrosensory advantage for prey detection over the conventional morphology of other rays (represented by the Atlantic stingray). The authors reported that while cownose rays had greater

numbers of pores and different pore distribution patterns than Atlantic stingray, the two species both demonstrated a sensitivity of approximately 7.5 nV cm⁻¹ to simulated bioelectric fields. The authors suggest that the pore distribution patterns of cownose rays may confer an advantage by allowing this species to place its electroreceptors in direct contact with the sediments in which its benthic prey resides.

Berquist, R. M. and M. G. Paulin. 2001. The virtual dogfish: An environment for modeling neural computations in cerebellar-like circuitry of the elasmobranch electrosensory system. *Neurocomputing* 38:1107-1112.

ANNOTATION: The authors developed a computational model to simulate the sensory processing capabilities of the spiny dogfish's (*Squalus acanthias*) electroreceptors.

Blonder, B. I. 1985. Prey discrimination and electroreception in the stingray *Dasyatis sabina*. Thesis. Florida Institute of Technology, Melbourne, Florida.

ANNOTATION: Masters Thesis on prey discrimination and electroreception in the stingray *Dasyatis sabina*.

Blonder, B. I. and W. S. Alevizon. 1988. Prey discrimination and electroreception in the stingray *Dasyatis sabina*. *Copeia*:33-36.

ANNOTATION: Electric fields in the range of 6-14 mV/cm were highly effective in stimulating attempts at feeding behavior on agar covered electrodes.

Bodznick, D., G. Hjelmstad, and M. V. L. Bennett. 1993. Accommodation to maintained stimuli in the ampullae of Lorenzini - how an electroreceptive fish achieves sensitivity in a noisy world. *Japanese Journal of Physiology* 43:S231-S237.

ANNOTATION: This article discusses how elasmobranchs may distinguish among complex and noisy electric signals.

Bodznick, D., J. Montgomery, and T. C. Tricas. 2003. Electroreception: extracting behaviorally important signals from noise. Pages 389-403 in S. P. Collin and N. J. Marshall, editors. *Sensory Processing in Aquatic Environments*. Springer-Verlag, New York.

ANNOTATION: The authors reviewed the behaviors that reflect electroreception and reviewed the peripheral and central processing of electric field stimuli.

Bodznick, D. and J. C. Montgomery. 1992. Suppression of ventilatory reafference in the elasmobranch electrosensory system - medullary neuron receptive-fields support a common-mode rejection mechanism. *Journal of Experimental Biology* 171:127-137.

ANNOTATION: This study explored the response of the primary electrosensory afferent nerves to $2\mu\text{V}/\text{cm}$ 2 Hz electric fields to investigate a proposed common-mode rejection mechanism that minimizes electrical noise in the afferents from the animals own ventilation.

Bodznick, D., J. C. Montgomery, and D. J. Bradley. 1992. Suppression of common-mode signals within the electrosensory system of the little skate *Raja erinacea*. *Journal of Experimental Biology* 171:107-125.

ANNOTATION: The bioelectric fields of prey animals attract some predators. This study measured the endogenous electric potentials associated with ventilation (5-150 μV), established the origin of the potentials, and measured neural afferent responses to 2 Hz, 2 $\mu\text{V}/\text{cm}$ sinusoidal electric fields.

Bodznick, D. and R. G. Northcutt. 1980. Segregation of electroreceptive and mechanoreceptive inputs to the elasmobranch medulla. *Brain Research* 195:313-321.

ANNOTATION: This reference appears to not be primarily relevant to identifying species in US waters with potential sensitivity to EMFs, or to understanding potential impacts. Nonetheless, it may provide useful supporting information, and has therefore been included in the database.

Bodznick, D. and R. G. Northcutt. 1984. An electrosensory area in the telencephalon of the little skate, *Raja erinacea*. *Brain Research* 298:117-124.

ANNOTATION: This reference appears to not be primarily relevant to identifying species in US waters with potential sensitivity to EMFs, or to understanding potential impacts. Nonetheless, it may provide useful supporting information, and has therefore been included in the database.

Bodznick, D. and A. W. Schmidt. 1984. Somatotopy within the medullary electrosensory nucleus of the little skate, *Raja erinacea*. *Journal of Comparative Neurology* 225:581-590.

ANNOTATION: This reference appears to not be primarily relevant to identifying species in US waters with potential sensitivity to EMFs, or to understanding potential impacts. Nonetheless, it may provide useful supporting information, and has therefore been included in the database.

Boord, R. L. and C. B. G. Campbell. 1977. Structural and functional organisation of the lateral line system of sharks. *American Zoologist* 17:431-441.

ANNOTATION: This article reviews the lateral line sense organs of sharks including ampullae of Lorenzini and neuromasts. The organs as well as function and purpose are discussed. Sharks detect very weak DC and low frequency AC electric fields from external sources and use this information to detect prey.

Boord, R. L. and R. G. Northcutt. 1982. Ascending lateral line pathways to the midbrain of the clearnose skate, *Raja eglanteria*. *Journal of Comparative Neurology* 207:274-282.

ANNOTATION: This paper reports on neural pathways between the lateral line and midbrain of the clearnose skate, *Raja eglanteria*. Segregation of electroreceptive and mechanoreceptive information is discussed.

Bratton, B. O. and J. L. Ayers. 1987. Observations on the electric organ discharge of 2 skate species (Chondrichthyes, Rajidae) and its relationship to behavior. *Environmental Biology of Fishes* 20:241-254.

ANNOTATION: Skates produce electric discharges and this discharge is stimulated by touch contact with other skates and electrical stimulation. The intensity of the discharge is 20 – 40 millivolts at frequencies of 7 - 8 Hz and the skates are also responsive to 0.2 Hz sinusoidal stimulation.

Braun, H. A., H. Wissing, K. Schafer, and M. C. Hirsch. 1994. Oscillation and noise determine signal-transduction in shark multimodal sensory cells. *Nature* 367:270-273.

ANNOTATION: The authors report that electrical stimuli do not affect the oscillation or spontaneous discharge of the receptors but do affect the probability of impulse generation.

Brill, R., P. Bushnell, L. Smith, C. Speaks, R. Sundaram, E. Stroud, and J. Wang. 2009. The repulsive and feeding-deterrent effects of electropositive metals on juvenile sandbar sharks (*Carcharhinus plumbeus*). *Fishery Bulletin* 107:298-307.

ANNOTATION: This study reported that sandbar sharks but not rays avoided metal bars that were electropositive, were deterred or delayed in feeding by the presence of electropositive bars within ~ 100 cm, and were less likely to be hooked if electropositive bars were present. These responses were interpreted as irritative responses mediated by an electroreceptive system.

Broun, G. R. and V. I. Govardovskii. 1983. Electroreceptor mechanisms of the ampullae of Lorenzini in skates. *Neurophysiology* 15:139-146.

ANNOTATION: This reference appears to not be primarily relevant to identifying species in US waters with potential sensitivity to EMFs, or to understanding potential impacts. Nonetheless, it may provide useful supporting information, and has therefore been included in the database.

Broun, G. R., O. B. Il'inskii, and B. V. Krylov. 1979. Responses of the ampullae of Lorenzini in a uniform electric field. *Neurophysiology* 11:118-124.

ANNOTATION: In experiments with the Black Sea ray, *Raja clavata*, the application of an electric field to a single electroreceptor showed a linear relationship between the discharge rate and the intensity of the electric field. The threshold for stimulation was 1-3 mV.

Brown, B. R. 2002. Modeling an electrosensory landscape: behavioral and morphological optimization in elasmobranch prey capture. *Journal of Experimental Biology* 205:999-1007.

ANNOTATION: This paper presents models of the elasmobranch's electrosensory system when approaching prey emitting an electric field.

Brown, B. R., M. E. Hughes, and C. Russo. 2005. Infrastructure in the electric sense: admittance data from shark hydrogels. *Journal of Comparative Physiology a-Neuroethology Sensory Neural and Behavioral Physiology* 191:115-123.

ANNOTATION: This reference appears to not be primarily relevant to identifying species in US waters with potential sensitivity to EMFs, or to understanding potential impacts. Nonetheless, it may provide useful supporting information, and has therefore been included in the database.

Brown, B. R., J. C. Hutchison, M. E. Hughes, D. R. Kellogg, and R. W. Murray. 2002. Electrical characterization of gel collected from shark electroreceptors. *Physical Review E* 65.

ANNOTATION: This reference appears to not be primarily relevant to identifying species in US waters with potential sensitivity to EMFs, or to understanding potential impacts. Nonetheless, it may provide useful supporting information, and has therefore been included in the database.

Brown, H. R. and O. B. Ilyinsky. 1978. Ampullae of Lorenzini in magnetic field. *Journal of Comparative Physiology* 126:333-341.

ANNOTATION: The authors report that the response of electroreceptor ampullae (in Black Sea skate, *Raja clavata*) was linearly related to the rate of change of the magnetic field (dB/dt). The effective induced potential was approximately 0.35 G. The threshold of the induced electric field was 0.16 mV/cm.

Bruner, L. J. and J. R. Harvey. 1995. The spike generation zone of the ampullary electroreceptor. 1. Stimulus-response characteristics of a relaxation-oscillator circuit model. *Biological Cybernetics* 72:371-378.

ANNOTATION: This reference appears to not be primarily relevant to identifying species in US waters with potential sensitivity to EMFs, or to understanding potential impacts. Nonetheless, it may provide useful supporting information, and has therefore been included in the database.

Bullock, T. H. 1973. Seeing the world through a new sense: Electroreception in fish. *Am Sci* 61:316-325.

ANNOTATION: This review focuses on the ability of elasmobranch and certain other fish species to actively or passively detect objects and communicate with other conspecifics by means of low and high frequency bioelectric fields.

Bullock, T. H. 1982. Electroreception. *Annual Review of Neuroscience* 5:121-170.

ANNOTATION: A comprehensive review of the evolution, anatomy, physiology, and electric field detection by marine species using ampullary organs and tuberous organs.

Bullock, T. H. 2005. *Electroreception*. Springer Science+Business Media, Inc., New York.

ANNOTATION: This book covers topics on electroreception ranging from morphology of sensory organs and neuroanatomy of sensory systems to physiology and behavior. Electrogenesis is also covered. The focus is on electric fish including such marine species as electric skates (*Rajidae*), electric rays (*Torpedinidae*), and electric stargazers (*Uranoscopidae*).

Bullock, T. H., D. A. Bodznick, and R. G. Northcutt. 1983. The phylogenetic distribution of electroreception - evidence for convergent evolution of a primitive vertebrate sense modality. *Brain Research Reviews* 6:25-46.

ANNOTATION: This review discusses phylogenetic relationships among organisms capable of electroreception and the evolution of the electric sense. Electroreception is well developed in *Petromyzoniformes* and in all other non-teleost fishes except *Holostei*, and probably *Myxiniiformes*. "Thus *Elasmobranchia*, *Holocephala*, *Dipneusti*, *Crossopterygii*, *Polypteriformes* and *Chondrostei* have the physiological and anatomical specializations in a common form consistent with a single origin in primitive vertebrates." However, the sense was lost in ancestors of holostean and teleostean fishes, then re-immersed in four groups: *Siluriformes*, *Gymnotiformes*, *Xenomystinae*, and *Mormyriiformes*. Thus, the authors contend that evidence for convergent evolution exists.

Bullock, T. H., S. Karamursel, and M. H. Hofmann. 1993. Interval-specific event-related potentials to omitted stimuli in the electrosensory pathway in elasmobranchs - an elementary form of expectation. *Journal of Comparative Physiology a-Sensory Neural and Behavioral Physiology* 172:501-510.

ANNOTATION: This paper reports on Omitted Stimulus Potentials (OSP) in the electrosensory system in the thornback ray and stingray (*Platyrrhinoidis triseriata*, *Urolophus halleri*). The authors conclude that OSPs appear in primary sensory nuclei and are then modified at midbrain and telencephalic levels. They do not require higher brain levels.

Bullock, T. H., R. G. Northcutt, and D. A. Bodznick. 1982. Evolution of electroreception. *Trends in Neurosciences* 5:50-53.

ANNOTATION: This review paper discusses the taxonomic distribution of electroreception and speculates about the evolution of this sense.

Camperi, M., T. C. Tricas, and B. R. Brown. 2007. From morphology to neural information: The electric sense of the skate. *Plos Computational Biology* 3:1083-1096.

ANNOTATION: The authors present an anatomically-based model to describe the dynamic function of the electrosensory system of the skate.

Chen, L., J. L. House, R. Krahe, and M. E. Nelson. 2005. Modeling signal and background components of electrosensory scenes. *Journal of Comparative Physiology a-Neuroethology Sensory Neural and Behavioral Physiology* 191:331-345.

ANNOTATION: This paper presents a computational model of electric field generation and electrosensory image or "scene" formation. This work was done to better characterize how weak signals produced by prey are differentiated from strong background noise. The knifefish (*Apteronotus albifrons*), a freshwater fish from South America, was used for this study; concepts could be applied to marine electric fish. The model provides a tool to estimate the spatial and temporal structure of electrosensory images in the natural environment.

Claiborne, J. B. and D. H. Evans. 2006. *The physiology of fishes*. CRC, Taylor & Francis, Boca Raton, FL.

ANNOTATION: Electroreception and electrogenesis are covered in chapter 12 of this book. Topics ranging from phylogeny, to passive and active electroreception, and physiological ecology of the electric sense are covered in this chapter.

Cliff, G. and S. F. J. Dudley. 1992. Protection against shark attack in South Africa, 1952-90. *Australian Journal of Marine and Freshwater Research* 43:263-272.

ANNOTATION: The authors review the effectiveness of electric barriers as an alternative to nets in the protection of bathers from shark attacks. The results as described were inconclusive.

Clusin, W. T. and M. V. L. Bennett. 1979a. Ionic basis of oscillatory responses of skate electroreceptors. *Journal of General Physiology* 73:703-723.

ANNOTATION: This reference appears to not be primarily relevant to identifying species in US waters with potential sensitivity to EMFs, or to understanding potential impacts. Nonetheless, it may provide useful supporting information, and has therefore been included in the database.

Clusin, W. T. and M. V. L. Bennett. 1979b. Oscillatory responses of skate electroreceptors to small voltage stimuli. *Journal of General Physiology* 73:685-702.

ANNOTATION: This study investigated responses of skate electroreceptors to small voltage stimuli. The post synaptic response of isolated electroreceptors to weak electric fields are described. Responses were detectable during stimuli as small as 5 μ V. Results substantiate the role of receptor cell excitability in the detection of small voltage changes.

Collin, S. P. and D. Whitehead. 2004. The functional roles of passive electroreception in non-electric fishes. *Animal Biology* 54:1-25.

ANNOTATION: This review discusses passive electroreception in elasmobranchs and other fishes. Functional roles of electroreception including prey detection, identification of predators and conspecifics, and the role of electroreception in social behavior are discussed. A case study of electroreception in the omnihaline bull shark, *Carcharhinus leucas*, is presented. Various theories regarding geomagnetic orientation in fishes are also discussed.

Conley, R. A. and D. Bodznick. 1994. The cerebellar dorsal granular ridge in an elasmobranch has proprioceptive and electroreceptive representations and projects homotopically to the medullary electrosensory nucleus. *Journal of Comparative Physiology a-Sensory Neural and Behavioral Physiology* 174:707-721.

ANNOTATION: This reference appears to not be primarily relevant to identifying species in US waters with potential sensitivity to EMFs, or to understanding potential impacts. Nonetheless, it may provide useful supporting information, and has therefore been included in the database.

Coombs, S., J. G. New, and M. Nelson. 2002. Information-processing demands in electrosensory and mechanosensory lateral line systems. *Journal of Physiology-Paris* 96:341-354.

ANNOTATION: This review compares structural, functional, behavioral, and information processing aspects of electrosensory and mechanosensory lateral line systems. Information processing for various electrosensitive species is discussed. The authors argue that electrosensory and mechanosensory lateral line systems are quite similar.

Dawson, B. G., G. W. Heyer, R. E. Eppi, and A. J. Kalmijn. 1980. Field experiments on electrically evoked feeding responses in the dogfish shark, *Mustelus canis*. *Biological Bulletin* 159:482-482.

ANNOTATION: The purpose of this study was to determine the electrosensitivity levels of dogfish shark pups and adults in their natural environment. Salt-bridge electrodes simulating prey fish were put out centrally located from chum in Vineyard Sound, off Cape Cod, Massachusetts. One-year old shark pups attacked electrodes from 15 to 18 cm away, which corresponded to an electro sensitivity of at least 0.04 to 0.02 $\mu\text{V}/\text{cm}$ respectively. Larger sharks showed higher sensitivity (from 0.01 to 0.005 $\mu\text{V}/\text{cm}$ or better) attacking from 30 to 38 cm along the dipole axis respectively. These results indicate that sharks are initially attracted to prey by smell, and rely on electrosensitivity during the final phase of the strike.

Dijkgraaf, S. 1964. Electoreception and the ampullae of Lorenzini in elasmobranchs. *Nature* 201.

ANNOTATION: Ampullae of Lorenzini are found on the heads of all Elasmobranchs and are used as electroreceptors capable of sensing 1 $\mu\text{V}/\text{cm}$. Behavioral experiments on rays and fish also showed muscular reactions to equal or smaller electrical stimuli 0.1 $\mu\text{V}/\text{cm}$.

Duman, C. H. and D. Bodznick. 1996. A role for GABAergic inhibition in electrosensory processing and common mode rejection in the dorsal nucleus of the little skate, *Raja erinacea*. *Journal of Comparative Physiology a-Neuroethology Sensory Neural and Behavioral Physiology* 179:797-807.

ANNOTATION: This study assessed electrosensory processing in the little skate, *Raja erinacea*, and mechanism's for addressing noise including electric signals from the animal's own ventilation.

Fields, R. D. 2007. The shark's electric sense. *Scientific American* 297:74-80.

ANNOTATION: A popular science article that discusses the electric sense in sharks.

Fields, R. D., M. H. Ellisman, and S. G. Waxman. 1987. Changes in synaptic morphology associated with presynaptic and postsynaptic activity - an in vitro study of the electrosensory organ of the thornback ray. *Synapse* 1:335-346.

ANNOTATION: This reference appears to not be primarily relevant to identifying species in US waters with potential sensitivity to EMFs, or to understanding potential impacts. Nonetheless, it may provide useful supporting information, and has therefore been included in the database.

Fields, R. D., K. D. Fields, and M. C. Fields. 2007. Semiconductor gel in shark sense organs? *Neuroscience Letters* 426:166-170.

ANNOTATION: The investigators examined the electrical and thermosensitive properties of the gel contained in the ampullae of Lorenzini of the skate. They found that the hypothesis that this sense organ is a temperature sensor was not supported by studies performed in the absence of electrochemical reactions produced by metal electrodes.

Filer, J. L., C. G. Booker, and D. W. Sims. 2008. Effects of environment on electric field detection by small spotted catshark *Scyliorhinus canicula* (L.). *Journal of Fish Biology* 72:1450-1462.

ANNOTATION: Response to prey simulating electric fields (applied current 15 μ A) under different substratum type and depth treatments was evaluated in the small spotted catshark (*Scyliorhinus canicula*). Response (turn and bite rates) was greatest for electrodes buried 10mm or less below the substrate surface, and no response was invoked for electrodes buried greater than 30mm. Response rates were greater for electrodes buried in sand than for those in pebbles or rocks. No response differences between sexes were reported.

Fishelson, L. and A. Baranes. 1998. Distribution, morphology, and cytology of ampullae of Lorenzini in the Oman shark, *Iago omanensis* (Triakidae), from the Gulf of Aqaba, Red Sea. *Anatomical Record* 251:417-430.

ANNOTATION: This reference appears to not be primarily relevant to identifying species in US waters with potential sensitivity to EMFs, or to understanding potential impacts. Nonetheless, it may provide useful supporting information, and has therefore been included in the database.

Fishelson, L. and A. Baranes. 1998. Morphological and cytological ontogenesis of the ampullae of Lorenzini and lateral line canals in the Oman Shark, *Iago omanensis* Norman 1939 (Triakidae), from the Gulf of Aqaba, Red Sea. *Anatomical Record* 252:532-545.

ANNOTATION: This reference appears to not be primarily relevant to identifying species in US waters with potential sensitivity to EMFs, or to understanding potential impacts. Nonetheless, it may provide useful supporting information, and has therefore been included in the database.

Freitas, R., G. J. Zhang, J. S. Albert, D. H. Evans, and M. J. Cohn. 2006. Developmental origin of shark electrosensory organs. *Evolution & Development* 8:74-80.

ANNOTATION: A study of the developmental origin of electrosensory organs in elasmobranchs. The study involved molecular analyses using the lesser spotted catshark (*Scyliorhinus canicula*). This paper appears to not be primarily relevant to identifying species in US waters with potential sensitivity to EMFs, or to understanding potential impacts. Nonetheless, it may provide useful supporting information, and has therefore been included in the database.

Frey, A. H. and E. S. Eichert. 1988. An analytic model of the electrosensory system of the fish. *Journal of Bioelectricity* 7:1-32.

ANNOTATION: The authors of this paper developed a model of the electro-sensory system of fish that would test how environmental parameters interact with electroreceptors. The model could be used in behavioral and physiological experiments and physical modeling.

Gibbs, M. A. 2004. Lateral line receptors: Where do they come from developmentally and where is our research going? *Brain Behavior and Evolution* 64:163-181.

ANNOTATION: This paper reviews available information on lateral line receptors, including electroreceptors, in fish. Evolution and phylogeny, morphology, and neural anatomy of electroreceptors are discussed.

Gill, A. B., Y. Huang, I. Gloyne-Phillips, J. Metcalfe, V. Quayle, J. Spencer, and V. Wearmouth. 2009. COWRIE 2.0 Electromagnetic Fields (EMF) Phase 2: EMF-sensitive fish response to EM emissions from sub-sea electricity cables of the type used by the offshore renewable energy industry. COWRIE Ltd. COWRIE-EMF-1-06. 128 pp.

ANNOTATION: A mesocosm study was conducted to determine whether electromagnetically sensitive fish respond to EMFs of the type and magnitude generated by offshore wind farm transmission cables. Three elasmobranch species were studied: The benthic Thornback Ray (*Raja clavata*), the freeswimming Spurdog (*Squalus acanthias*) and benthic Small-spotted Catshark/Lesser-spotted Dogfish (*Scyliorhinus canicula*). Responses were reported for the benthic species, thornback Ray and small-spotted Catshark.

EMF measurements were made at transmission cables of existing wind projects. The North Hoyle windfarm was the first major UK offshore windfarm with a capacity of 90 MW and began operation in 2004. The Burbo Bank windfarm, also with a 90 MW capacity, is located nearby and began operation in 2007. Power is transmitted 9 - 10 km to shore locations over 36kV XLPE

armored cables. Gill et al. (2009) reports on measurements of electric and magnetic fields near the underwater cables.

Gill, A. B. and A. A. Kimber. 2005. The potential for cooperative management of elasmobranchs and offshore renewable energy development in UK waters. *Journal of the Marine Biological Association of the United Kingdom* 85:1075-1081.

ANNOTATION: This paper reviews potential impacts to elasmobranchs in UK waters from offshore renewable energy projects and suggests cooperative management strategies for elasmobranch conservation and offshore renewable energy development (ORED). Impacts related to EMF are reviewed and discussed.

Gill, A. B. and H. Taylor. 2001. The potential effects of electromagnetic fields generated by cabling between offshore wind turbines upon elasmobranch fishes. Countryside Council for Wales. Contract Science Report 488. 60 pp.

ANNOTATION: This report reviews potential impacts to British elasmobranchs from electromagnetic fields generated by undersea power transmission cables for offshore wind projects. The report includes results of literature reviews covering electroreception in elasmobranchs, offshore wind developments in Europe and associated environmental effects, and the biology of British elasmobranchs. The report also presents results of a pilot study, using the Lesser spotted dogfish (*Scyliorhinus canicula*), to compare behavioural responses to electric fields simulating those produced by prey items and by a typical power transmission cable. The authors report an avoidance response (variable among individuals) to electric fields at 10 μ V/cm (simulating cables) and an attraction response to fields at 0.1 μ V/cm, 10cm from the source (simulating prey). The report also includes a discussion of future research priorities.

Haine, O. S., P. V. Ridd, and R. J. Rowe. 2001. Range of electrosensory detection of prey by *Carcharhinus melanopterus* and *Himantura granulata*. *Marine and Freshwater Research* 52:291-296.

ANNOTATION: This study measured the bioelectric fields produced by hermit crabs (*Pagurus* sp., *Matuta* sp., and *Sesarma* sp.) and fish (*Pomacentrus amboinensis*, *Sillago sihama*, *Gerres filamentosus*, *Himantura granulata*, *Carcharhinus melanopterus*). Based upon the reported electrosensitivity of the elasmobranch, the authors calculated that elasmobranchs can detect electric fields produced by prey at distances within about 0.5 meters.

Harvey, J. R. and L. J. Bruner. 1995. The spike generation zone of the ampullary electroreceptor. 2. Oscillator period noise and the limits of sensitivity. *Biological Cybernetics* 72:379-387.

ANNOTATION: The purpose of this study was to determine the sensitivity level of Elasmobranchs to the marine electric field by maximizing the sensitivity level of a modeled

afferent nerve fiber found within electroreceptor organs in these fish. The model results showed that Elasmobranchs' electroreceptive sensitivity is provable with well known physical principals.

Heijmen, P. S., A. Boele, and R. C. Peters. 1996. The effect of hyperosmotic treatment on the functioning of ampullary electroreceptor organs. *Neuroscience* 72:1107-1115.

ANNOTATION: This reference appears to not be primarily relevant to identifying species in US waters with potential sensitivity to EMFs, or to understanding potential impacts. Nonetheless, it may provide useful supporting information, and has therefore been included in the database.

Heyer, G. W., M. C. Fields, R. D. Fields, and A. J. Kalmijn. 1981. Field experiments on electrically evoked feeding responses in the pelagic blue shark, *Prionace glauca*. *Biological Bulletin* 161:344-345.

ANNOTATION: The purpose of this study was to test blue sharks' response to electrically stimulated prey. Salt-bridge electrodes were placed 30 cm from chum (olfactory attractant) which created a radius of current gradients that decreased to 5 nV/cm within 24-30 cm. A majority (31 of 40) of bites were made to the activated dipole, compared to only 7 of 40 bites that were made on the unactivated dipole. These results showed that blue sharks will strike an electric-field source simulating prey.

Hjelmstad, G. O., G. Parks, and D. Bodznick. 1996. Motor corollary discharge activity and sensory responses related to ventilation in the skate vestibulolateral cerebellum: Implications for electrosensory processing. *Journal of Experimental Biology* 199:673-681.

ANNOTATION: This reports the investigation of spontaneous electrophysiological activity related to ventilation and responses to electric fields of 1-20 μ V/cm.

Johnson, C. S., B. L. Scronce, and M. W. McManus. 1984. Detection of dc electric dipoles in background fields by the nurse shark. *Journal of Comparative Physiology* 155:681-687.

ANNOTATION: The authors report that the nurse shark was able to detect DC electric fields and AC electric fields with frequencies less than 1.6 Hz. The ability to detect the electric field increased with background fields between 0.01 to 0.4 mV/cm. The threshold for detection was between 0.02 to 0.03 Hz of background stimuli.

Kajiura, S. M. 2001a. Electroreception in carcharhinid and sphyrynid sharks. Thesis. University of Hawaii at Manoa. 109 pp.

ANNOTATION: This Thesis (Ph.D.) presents results of research on electroreception in carcharhinid and sphyrynid sharks.

Kajiura, S. M. 2001b. Head morphology and electrosensory pore distribution of carcharhinid and sphyrnid sharks. *Environmental Biology of Fishes* 61:125-133.

ANNOTATION: This study compared head morphology and the distribution, number, and density of electrosensory pores on the scalloped hammerhead (*Sphyrna lewini*), the bonnethead (*S. tiburo*), and the sandbar shark (*Carcharhinus plumbeus*). This study tested the "enhanced electrosensory hypothesis" which states that "the laterally expanded sphyrnid cephalofoil maximizes search area coverage to increase the probability of detecting prey." The authors conclude that the head morphology and distribution, number, and density of electrosensory pores in hammerhead sharks provides enhanced electroreceptive capabilities compared to comparably sized carcharhinids.

Kajiura, S. M. 2003. Electroreception in neonatal bonnethead sharks, *Sphyrna tiburo*. *Marine Biology* 143:603-611.

ANNOTATION: The median threshold for the sharks to initiate attack behavior on the electrodes was measured as 47 nV/cm with a minimum response threshold of < 1 nV/cm (frequency not specified). The maximum distance at which orientation to the dipole occurred was 22 cm. Author suggests that this is the first demonstration of innate feeding response to electric stimuli in a chondrichthyan fish.

Kajiura, S. M. and T. P. Fitzgerald. 2009. Response of juvenile scalloped hammerhead sharks to electric stimuli. *Zoology* 112:241-250.

ANNOTATION: The authors report that juvenile scalloped hammerhead sharks attack electric field sources as if they were prey with a threshold of less than 10 nanovolts/cm. The electric fields could be detected by the sharks out to 40 cm from the electrodes.

Kajiura, S. M. and K. N. Holland. 2002. Electroreception in juvenile scalloped hammerhead and sandbar sharks. *Journal of Experimental Biology* 205:3609-3621.

ANNOTATION: This study compared behavioral responses of similarly sized carcharhinid (sandbar shark) and sphyrnid (scalloped hammerhead) sharks to prey-simulating electric stimuli. The median behavioral response threshold to dipole electric fields simulating prey stimuli was similar for the two species (0.0252 μ V/cm-scalloped; 0.0303 μ V/cm-sandbar).

Kalmijn, A. 1984. Theory of electromagnetic orientation: a further analysis. Pages 525-564 in L. Bolis, R. D. Keynes, and S. H. O. Maddess, editors. *Comparative Physiology of Sensory Systems* Cambridge University Press, Cambridge.

ANNOTATION: This review provides a very clear discussion of the physics underlying potential mechanisms by which elasmobranchs may actively and passively detect magnetic and electric fields.

Kalmijn, A. J. 1966. Electro-perception in sharks and rays. *Nature* 212:1232-&.

ANNOTATION: The author reports that the sensitivity of these elasmobranch species (*Scyliorhinus canicula* and *Raja clavata*) to the square wave 5 Hz AC electric field threshold was as low as 0.01 mV/cm for slowing of heart rate.

Kalmijn, A. J. 1971. The electric sense of sharks and rays. *Journal of Experimental Biology* 55:371-383.

ANNOTATION: This study demonstrated that sharks (*Scyliorhinus canicula*) and rays (*Raja clavata*) attacked prey fish based upon the emitted electric field. Shielding of the prey fish by insulating materials blocked the attack response. The threshold for detection was approximately 0.01 μ V/cm.

Kalmijn, A. J. 1972. Bioelectric Fields in Sea Water and the Function of the Ampullae of Lorenzini in Elasmobranch Fishes. Prepared for the Office of Naval Research by Scripps Institution Of Oceanography, La Jolla, CA. SIO Reference No. 72-83. 24 pp.

ANNOTATION: This report on the functioning of the Ampullae of Lorenzini in sensing electric fields was prepared for the Office of Naval Research. The report reviewed research on topics ranging from neuroanatomy and physiology to behavior.

Kalmijn, A. J. 1974. The detection of electric fields from inanimate and animate sources other than electric organs. Pages 147-200 in A. Fessard, editor. *Handbook of Sensory Physiology* (Vol. 3). Springer-Verlag, New York.

ANNOTATION: This book chapter describes the sources of electric fields that occur in the ocean, including those of physical, electrochemical and biological origins. Described and modeled are the physical processes involved in the induction of electric currents by the movement of streaming water currents and swimming fish through the earth's magnetic field. Responses of marine and freshwater animals to weak electric fields are reviewed, with particular focus on information known on marine sharks and rays at that time. The varied responses of ampullary receptors to mechanical, thermal, chemical and electrical stimuli are reviewed. The biological significance of the electric sensitivity in sharks and rays is stated to involve detection of prey but may also involve detection of electric fields via magnetic induction. Receptor responses in relation to natural stimuli are presented.

Kalmijn, A. J. 1982. Electric and magnetic-field detection in elasmobranch fishes. *Science* 218:916-918.

ANNOTATION: Electric and magnetic field detection in elasmobranch fishes was investigated in field and laboratory studies. Feeding responses to dipole electric fields (5 nV/cm) designed to mimic prey were observed at sea in dogfish and blue sharks. Stingrays in laboratory experiments showed the ability to orient relative to uniform electric fields (5 nV/cm) similar to those produced by ocean currents. Dogfish attacked electrodes that produced an electric field approx 0.005 mV/cm at threshold. The ability of stingrays to detect magnetic fields was inconsistent.

Kalmijn, A. J. 1988. Detection of weak electric fields. Pages 151-186 in J. Atema, R. R. Fay, A. N. Popper, and W. N. Tavolga, editors. *Sensory Biology of Aquatic Animals*. Springer-Verlag, New York.

ANNOTATION: This book chapter reviews the detection of weak electric fields.

Kalmijn, A. J. 1997. Electric and near-field acoustic detection, a comparative study. Pages 25-38.

ANNOTATION: The author presents his hypothesis that the bioelectric detection of prey by elasmobranchs is analogous to acoustic detection in that receptors respond to the rate of change of stimulation.

Kalmijn, A. J. 2000. Detection and processing of electromagnetic and near-field acoustic signals in elasmobranch fishes. *Phil. Trans. R. Soc. B*:1135-1141.

ANNOTATION: This paper discusses similarities among the acoustic and electrical sensory modalities used by elasmobranch fishes to detect prey.

Kalmijn, A. J., I. F. Gonzalez, and M. C. McClune. 2002. The physical nature of life. *Journal of Physiology-Paris* 96:355-362.

ANNOTATION: This review discusses electro- and magnetoreception in elasmobranchs. Mechanisms and physical aspects of these senses are discussed including motional-electric principles and Einstein's special theory of relativity.

Kalmijn, A. J. and M. B. Weinger. 1981. An electrical simulator of moving prey for the study of feeding strategies in sharks, skates, and rays. *Annals of Biomedical Engineering* 9:363-367.

ANNOTATION: Simulated bioelectric fields of moving prey were used to study feeding strategies in sharks, skates, and rays. Simulated prey fish speed (1-100 cm/s) and output current strength (1-10 μ A) were remotely controlled to determine if predators struck prey from a

distance or approached gradually (which would require a change in course). The results showed that after their initial strike, these fish did not follow up with any course corrections.

Kalmijn, J. 1989. Biophysics of Electroreception Workshop on Transduction of Nanovolt Signals: Limits of Electric-Field Detection Held in La Jolla, California on 19-21 November 1989. Scripps Institution Of Oceanography La Jolla, CA pp.

ANNOTATION: Proceedings from a conference on electroreception in elasmobranchs. From US Defense Technical Information Center: "Life scientists of diverse backgrounds gathered in La Jolla, California, for three days in November 1989 to discuss the extreme electrical sensitivity of marine sharks, skates, and rays. After reviewing the results of earlier studies on the electric sense at the animal and system levels, the participants discussed the basic process of signal transduction in terms of voltage-sensitive ionic channels. Struck by the small charge displacements needed for excitation, they strongly recommended that sensory biologists, physiologists, and biophysicists join in a concerted effort to initiate new research on the ionic mechanisms of electric-field detection. To obtain detailed information on the electroreceptive membrane and its ionic channels, high-resolution recording techniques will be mandatory. (eg). "

Kimber, J. A., D. W. Sims, P. H. Bellamy, and A. B. Gill. 2009. Male-female interactions affect foraging behaviour within groups of small-spotted catshark, *Scyliorhinus canicula*. *Animal Behaviour* 77:1435-1440.

ANNOTATION: The authors report that foraging behavior of sharks (*Scyliorhinus canicula*) to artificial electric field stimuli was greater among female than male sharks. The threshold was approximately 0.95 $\mu\text{V}/\text{cm}$ and an increase in responses was seen in electric fields in 9.5 $\mu\text{V}/\text{cm}$.

Klimley, A. P., R. L. Kihlslinger, and J. T. Kelly. 2005. Directional and non-directional movements of bat rays, *Myliobatis californica*, in Tomales Bay, California. *Environmental Biology of Fishes* 74:79-88.

ANNOTATION: This study reports that the travel strategies of bat rays is consistent with following geomagnetic gradients but that it is also possible that visual landmarks and depth contours are important aids as well.

Lowe, C. G., R. N. Bray, and D. R. Nelson. 1994. Feeding and associated electrical behavior of the Pacific electric ray *Torpedo californica* in the field. *Marine Biology* 120:161-169.

ANNOTATION: This study investigated feeding behavior in the Pacific electric ray (*Torpedo californica*). Attacks by rays on energized electrodes provide the first evidence that electric rays use electroreceptors to detect their prey.

Lu, J. and H. M. Fishman. 1994. Interaction of apical and basal membrane ion channels underlies electroreception in ampullary epithelia of skates. *Biophysical Journal* 67:1525-1533.

ANNOTATION: The authors show that the electrophysiological response of the ampullary organ is a linear function of the applied intensity of 0.5 Hz electric fields. An important observation is that the threshold for stimulation of spike responses was 10-fold less than reported by Bennett and Clusen (1978), which appears to be related to the much lower resting potentials in this study.

Lu, J. and H. M. Fishman. 1995a. Ion channels and transporters in the electroreceptive ampullary epithelium from skates. *Biophysical Journal* 69:2467-2475.

ANNOTATION: This reference appears to not be primarily relevant to identifying species in US waters with potential sensitivity to EMFs, or to understanding potential impacts. Nonetheless, it may provide useful supporting information, and has therefore been included in the database.

Lu, J. and H. M. Fishman. 1995b. Localization and function of the electrical oscillation in electroreceptive ampullary epithelium from skates. *Biophysical Journal* 69:2458-2466.

ANNOTATION: This reference appears to not be primarily relevant to identifying species in US waters with potential sensitivity to EMFs, or to understanding potential impacts. Nonetheless, it may provide useful supporting information, and has therefore been included in the database.

Mackenzie, D. 1986. Shark bites halt trans-Atlantic cable. *New Scientist* 111:18-18.

ANNOTATION: Popular science article discusses the phenomenon of sharks biting trans-Atlantic cable.

Marcotte, M. M. and C. G. Lowe. 2008. Behavioral responses of two species of sharks to pulsed, direct current electrical fields: Testing a potential shark deterrent. *Marine Technology Society Journal* 42:53-61.

ANNOTATION: This study investigated behavioral responses of scalloped hammerhead (*Sphyrna lewini*) and leopard sharks (*Triakis semifasciata*) to an electrical deterrent. A retreat behavioral response occurred at a mean, maximum threshold of 18.50 ± 13.27 V/m in hammerhead sharks and at a mean, maximum threshold of 9.64 ± 10.28 V/m in leopard sharks ;. "head twitch" and "shimmy" behavioral responses were elicited at lower voltage gradient thresholds.

Marra, L. J. 1989. Sharkbite on the SL submarine lightwave cable system: history, causes and resolution. *IEEE Journal of Oceanic Engineering* 14:230-237.

ANNOTATION: This paper discusses the phenomenon of sharks biting a submarine lightwave cable system in the Canary Islands at water depths of 1,060 to 1,900 m. Shark species are identified based on recovered teeth and the causes for the attacks are discussed. The author suggests that electromagnetic fields could attract the sharks to the cable.

McCleave, J. D., S. A. J. Rommel Jr., and C. L. Cathcart. 1971. Weak electric and magnetic fields in fish orientation. *Annals of the New York Academy of Sciences* 188:270-281.

ANNOTATION: Evidence is available for the high sensitivity of fish to electric fields but not for the ability to detect weak magnetic fields. The following fish have known electroreceptive organs and can detect the following electric levels: Gymnotidae and Mormyridae (0.03 $\mu\text{V}/\text{cm}$), small-spotted catsharks and skates (0.01 $\mu\text{V}/\text{cm}$), and bullhead sharks (30 $\mu\text{V}/\text{cm}$). The authors questioned whether migratory fish are electrosensitive or magnetosensitive.

McGowan, D. W. and S. M. Kajiura. 2009. Electroreception in the euryhaline stingray, *Dasyatis sabina*. *Journal of Experimental Biology* 212:1544-1552.

ANNOTATION: This study showed that the spatial dispersion of DC electric field stimuli simulating prey stimuli is greater in fresh water than in brackish water but that the electrosensitivity of species taken from these different environments was similar. Stingrays from both locations showed ~200-fold greater sensitivity to electric fields in the brackish water compared to fresh water. In brackish and saltwater water, the median treatments were 6nVcm(-1) and the maximum orientation distance was 44cm.

Montgomery, J. C. 1984a. Frequency-response characteristics of primary and secondary neurons in the electrosensory system of the thornback ray. *Comparative Biochemistry and Physiology A-Physiology* 79:189-195.

ANNOTATION: This paper examined the frequency response characteristics of primary and secondary neurons in the electrosensory organs of the thornback skate. The responses of the afferent neurons were recorded during sinusoidal modulation. Results showed that the maximum amplitude of response was observed at a frequency of 4 Hz.

Montgomery, J. C. 1984b. Noise cancellation in the electrosensory system of the thornback ray - common-mode rejection of input produced by the animals own ventilatory movement. *Journal of Comparative Physiology* 155:103-111.

ANNOTATION: Sharks, rays, and skates possess ampullae of Lorenzini, electroreceptive organs used to detect prey. Under normal conditions, fish that are being preyed upon by Elasmobranchs create attenuating bioelectric fields out to approximately 30 cm (for small prey). However, the respiration of the predatory Elasmobranch simultaneously creates similar electric fields. The purpose of this study was to determine the clustering aspect of ampullae enable electroreceptor

system to suppress respiratory movements by “common mode rejection”. Results showed that electro-ventilatory interference is removed by common mode rejection and therefore the predator is able to differentiate/detect prey (i.e. the predator’s own respiratory activity does not interfere with their detection of prey).

Montgomery, J. C. and D. Bodznick. 1993. Hindbrain circuitry mediating common-mode suppression of ventilatory reafference in the electrosensory system of the little skate, *Raja erinacea*. *Journal of Experimental Biology* 183:203-215.

ANNOTATION: The electrophysiological response of the electrosensory system to 2 $\mu\text{V}/\text{cm}$, sinusoidal 2 Hz electric fields was studied. The study specifically investigated mechanisms used by little skate, *Raja erinacea*, to process electrical signals despite noise from the animal's own ventilation.

Montgomery, J. C. and D. Bodznick. 1994. An adaptive filter that cancels self-induced noise in the electrosensory and lateral-line mechanosensory systems of fish. *Neuroscience Letters* 174:145-148.

ANNOTATION: Fish with electrosensory systems use this system to sense movements of other fish. However, those fish with electrosensory systems also create their own movements that may confound important external information. The authors determined that movements of electrosensory fish are neurologically filtered out, and that their own “noise” does not interfere with their ability to sense important biological information from other fish.

Montgomery, J. C. and D. Bodznick. 1999. Signals and noise in the elasmobranch electrosensory system. *Journal of Experimental Biology* 202:1349-1355.

ANNOTATION: This review describes how elasmobranches detect electric fields of prey by passive mechanisms and electric field gradients generated by their own motion through the water and the mechanisms involved in reducing interference from their own bioelectric fields. The review focuses on biologically relevant stimuli that range from DC to 10 Hz.

Murray, R. W. 1960. Electrical sensitivity of the ampullae of Lorenzini. *Nature* 187:957.

ANNOTATION: Electrophysiological experiments revealed that the ampullae of Lorenzini found in Elasmobranchs are sensitive to slight changes in temperature and weak mechanical stimuli. However, the author is not convinced that either of these parameters are biologically important stimuli for the ampullae.

Murray, R. W. 1962. The response of the ampullae of Lorenzini in elasmobranchs to electrical stimulation. *Journal of Experimental Biology* 39:119-128.

ANNOTATION: This paper is a discussion of the sensitivity of the ampullae of Lorenzini, which are known to detect electrical stimuli and consequently salinity changes. In the laboratory, current strengths of 10^{-9} were measured directly, and strengths below that level were calculated. Sensitivity in fish to electrical stimuli falls into two categories: 1) navigation function in fish with weak electric organs, and 2) unnatural conditions of galvanotaxis. Experiments on electric knifefish (*Gymnarchus niloticus*) resulted in sensitivity levels to changes in voltage gradient in water of $0.03 \mu\text{V}/\text{cm}$ (also $0.15 \mu\text{V}/\text{cm}$). Electrophysical measurements showed that *Gymnotus* and *Hypopomus* (electric fish) were sensitive to differences in voltage gradients of $50\text{-}1000 \mu\text{V}/\text{cm}$. When a stimulus was applied as a voltage gradient in water over the ampullae experimentally, the threshold of sensitivity was $1 \mu\text{V}/\text{cm}$. Ampullae are within the ranges of sensitivity in fish that use electric organs for navigation. A potential use of electrically sensitive ampullae is the detection of the Earth's magnetic field (although The Earth's magnetic field appears to be 1 order of magnitude lower than the detection level of ampullae).

Nelson, M. E. and M. G. Paulin. 1995. Neural simulations of adaptive reafference suppression in the elasmobranch electrosensory system. *Journal of Comparative Physiology a-Sensory Neural and Behavioral Physiology* 177:723-736.

ANNOTATION: This reference appears to not be primarily relevant to identifying species in US waters with potential sensitivity to EMFs, or to understanding potential impacts. Nonetheless, it may provide useful supporting information, and has therefore been included in the database.

New, J. G. 1990. Medullary electrosensory processing in the little skate .1. Response characteristics of neurons in the dorsal octavolateralis nucleus. *Journal of Comparative Physiology a-Sensory Neural and Behavioral Physiology* 167:285-294.

ANNOTATION: The purpose of this study was to experimentally test the response characteristics of specific nerve fibers and the dorsal octavolateralis nucleus to weak D.C. stimuli in the little skate. Results showed that peak sensitivity of these electrosensitive neurons was between 5-10 Hz.

New, J. G. 1994. Electric organ discharge and electrosensory reafference in skates. *Biological Bulletin* 187:64-75.

ANNOTATION: Skates possess electric organs capable of producing weak discharges, and like all elasmobranchs, they have an electrosensory system that can detect weak electric fields. Several studies have suggested that the weak discharges may be used for social communication. This study examined the stimulation of electroreceptors and recorded spontaneous electric organ discharges in skates. Results suggest that electric organ discharges may indeed serve a communication role.

New, J. G. and D. Bodznick. 1985. Segregation of electroreceptive and mechanoreceptive lateral line afferents in the hindbrain of chondrosteian fishes. *Brain Research* 336:89-98.

ANNOTATION: This reference appears to not be primarily relevant to identifying species in US waters with potential sensitivity to EMFs, or to understanding potential impacts. Nonetheless, it may provide useful supporting information, and has therefore been included in the database.

New, J. G. and D. Bodznick. 1990. Medullary electrosensory processing in the little skate. 2. Suppression of self-generated electrosensory interference during respiration. *Journal of Comparative Physiology a-Sensory Neural and Behavioral Physiology* 167:295-307.

ANNOTATION: It is known that respiration causes movements in the water surrounding individual fish (i.e. little skate in this case). Modulation of the individual fish respirations is due to internal potential fluctuations, not external ventilatory potentials (in the water). The authors ask the question of whether this self-stimulatory respiration interferes with fishes' abilities to detect biologically important weak fields in its environment. Results showed that a common-mode rejection mechanism for suppressing ventilatory electrosensory reafference exists.

New, J. G. and T. C. Tricas. 1997. Electroreceptors and Magnetoreceptors: Morphology and Function. Pages 741-758 *in* N. Sperlakis, editor. *Cell Physiology Source Book*, 2nd ed. Academic Press, San Diego.

ANNOTATION: This book chapter reviews the morphology and function of electroreceptors and magnetoreceptors.

Obara, S. and M. V. L. Bennett. 1972. Mode of operation of ampullae of Lorenzini of the skate, *Raja*. *J. Gen. Physiol.* 60:534-557.

ANNOTATION: Electroreceptors in marine elasmobranchs are significantly more sensitive than those in freshwater teleosts (approximately 50-100 times). Electroreceptors are found in nonelectric and electric fish. These electroreceptor organs are comprised of groups of individual ampullae clustered together in several capsules in the cranial region of most, if not all Elasmobranchs. Canals run from each ampulla to the exterior of the skin. Receptor cells (found in the walls of the ampullae) are acted upon by differences in potential of the canal opening (exterior) and the interior ampullae. Results of this study showed that receptor cells of ampullae are electrically excitable, able to generate spikes, and can chemically transmit information to innervating fibers.

Öhman, M. C., P. Sigraý, and H. Westerberg. 2007. Offshore windmills and the effects of electromagnetic fields on fish. *Ambio* 36:630-633.

ANNOTATION: This paper reviews potential effects on fish from electromagnetic fields from transmission cables for offshore wind parks. Magnetic fields associated with underwater electrical transmission cables are characterized. Studies investigating behavioral and physiological effects from magnetic fields on fish are reviewed and discussed.

Pals, N., R. C. Peters, and A. A. C. Schoenhage. 1982. Local geo-electric fields at the bottom of the sea and their relevance for electrosensitive fish. *Netherlands Journal of Zoology* 32:479-494.

ANNOTATION: This paper reports on seafloor sources of EMFs and relevance to electroreceptive fish.

Pals, N., P. Valentijn, and D. Verwey. 1982. Orientation reactions of the dogfish, *Scyliorhinus canicula*, to local electric fields. *Netherlands Journal of Zoology* 32:495-512.

ANNOTATION: An electric field of 50 mV/m elicited prey catching reactions in dogfish (*Scyliorhinus canicula*) during experiments. Switching on the electric field to a resting dogfish produced the same reactions as acoustic or mechanical stimuli.

Paulin, M. G. 1995. Electroreception and the compass sense of sharks. *Journal of Theoretical Biology* 174:325-339.

ANNOTATION: This review presents a theory that explains how an elasmobranch could use its electric sense to determine compass bearing via induced electroreceptor voltages.

Peters, R. C., L. B. M. Eeuwes, and F. Bretschneider. 2007. On the electroreception threshold of aquatic vertebrates with ampullary or mucous gland electroreceptor organs. *Biological Reviews* 82:361-373.

ANNOTATION: This paper reviews and reinterprets results of research on the electric sense in aquatic organisms with ampullary organs. The authors report that the lower detection limit for marine fish is 1 nV/cm (with angular movements) to 20 nV/cm. The importance of angular movements for stimulation of the ampullary system is discussed. Differences in electroreception between benthic and pelagic fish species and between marine and limnic species are discussed.

Peters, R. C. and H. P. Evers. 1985. Frequency-selectivity in the ampullary system of an elasmobranch fish (*Scyliorhinus canicula*). *Journal of Experimental Biology* 118:99-109.

ANNOTATION: This study examines the frequency response of afference to the electroreceptive system. A maximum response was exhibited at a frequency of 5 Hz. The sensitivity of the respiratory reflex to electrical stimulation showed a peak sensitivity in the range from 0.1 to 1 Hz and intensity of 40 nanovolt/cm peak to peak.

Petracchi, D. and G. Cercignani. 1998. A comment on the sensitivity of fish to low electric fields. *Biophysical Journal* 75:2117-2118.

ANNOTATION: This commentary suggests that the ability of elasmobranch to detect weak electric fields can be investigated by analytical tools commonly applied.

Pickard, W. F. 1988. A model for the acute electrosensitivity of cartilaginous fishes. *Ieee Transactions on Biomedical Engineering* 35:243-250.

ANNOTATION: The author discussed the following theories to explain the acute electrosensitivity found in Elasmobranchs: 1) electro-stimuli are focused on specialized receptor organs, the ampullae of Lorenzini, 2) these stimuli modulate the repetitive discharge of the primary afferent nerve fibers which innervate the ampullae, and 3) these nerve fibers are centrally clustered, which increases the signal-to-noise ratio. The author demonstrated that predicted threshold levels of electroreception are close to observed levels.

Puzdrowski, R. L. and R. B. Leonard. 1993. The octavolateral systems in the stingray, *Dasyatis sabina*. 1. Primary projections of the octaval and lateral line nerves. *Journal of Comparative Neurology* 332:21-37.

ANNOTATION: This reference appears to not be primarily relevant to identifying species in US waters with potential sensitivity to EMFs, or to understanding potential impacts. Nonetheless, it may provide useful supporting information, and has therefore been included in the database.

Raschi, W. 1978. Notes on gross functional-morphology of ampullary system in two similar species of skates, *Raja erinacea* and *Raja ocellata*. *Copeia*:48-53.

ANNOTATION: This reference appears to not be primarily relevant to identifying species in US waters with potential sensitivity to EMFs, or to understanding potential impacts. Nonetheless, it may provide useful supporting information, and has therefore been included in the database.

Raschi, W. 1986. A morphological analysis of the ampullae of Lorenzini in selected skates (Pisces, Rajoidei). *Journal of Morphology* 189:225-247.

ANNOTATION: This study compared ampullae of Lorenzini among 40 species of skates (Rajoidei). The number, size, location, and distribution of ampullary pores demonstrated a relationship between inferred electroreceptive capabilities and natural history characteristics including preferred prey and depth distribution.

Raschi, W. and W. H. Adams. 1988. Depth-related modifications in the electroreceptive system of the eurybathic skate, *Raja radiata* (Chondrichthyes, Rajidae). *Copeia*:116-123.

ANNOTATION: This study investigated depth-related intra-specific differences in the structure and morphology of the electrosensory system (ampullae of Lorenzini) in the eurybathic skate, *Raja radiata*. The authors report increased ampullae size (which suggests enhanced sensitivity to electric fields) at greater depths.

Raschi, W. and L. A. Mackanos. 1987. Evolutionary trends in the peripheral component of chondrichthyan electroreceptors - a morphological review. *Archives of Biology* 98:163-186.

ANNOTATION: This reference appears to not be primarily relevant to identifying species in US waters with potential sensitivity to EMFs, or to understanding potential impacts. Nonetheless, it may provide useful supporting information, and has therefore been included in the database.

Ryan, P. R. 1981. Electroreception in blue sharks. *Oceanus* 24:42-44.

ANNOTATION: It is known that sharks detect low levels of electric fields with the ampullae of Lorenzini. The purpose of this study was to test blue sharks' behavioral responses to electrically charged (8 μ A). The field of current decreased to 5 nanovolts/cm within 24 to 30 cm from the electrodes. Of the 40 attacks, 7 were made onto the unactivated dipole, and 31 were made onto the activated dipole. These results show the blue sharks' significant preference for current-carrying electrodes/prey. Elasmobranchs may also possess an electromagnetic compass sense, receiving electrical information and also orienting to the Earth's magnetic field.

Salyapongse, A., G. Hjelmstad, and D. Bodznick. 1992. 2nd-order electroreceptive cells in skates have response properties dependent on the configuration of their inhibitory receptive fields. *Biological Bulletin* 183:349-349.

ANNOTATION: This study reports that the response of receptor neurons can be elicited by electric fields with intensities by < 5 microvolts.

Schweitzer, J. 1983. The physiological and anatomical localization of 2 electroreceptive diencephalic nuclei in the thornback ray, *Platyrhinoidis triseriata*. *Journal of Comparative Physiology* 153:331-341.

ANNOTATION: This reference appears to not be primarily relevant to identifying species in US waters with potential sensitivity to EMFs, or to understanding potential impacts. Nonetheless, it may provide useful supporting information, and has therefore been included in the database.

Schweitzer, J. 1986. Functional organization of the electroreceptive midbrain in an elasmobranch (*Platyrhinoidis triseriata*) - a single-unit study. *Journal of Comparative Physiology a-Sensory Neural and Behavioral Physiology* 158:43-58.

ANNOTATION: This reference appears to not be primarily relevant to identifying species in US waters with potential sensitivity to EMFs, or to understanding potential impacts. Nonetheless, it may provide useful supporting information, and has therefore been included in the database.

Sisneros, J. A. and T. C. Tricas. 2000. Androgen-induced changes in the response dynamics of ampullary electrosensory primary afferent neurons. *Journal of Neuroscience* 20:8586-8595.

ANNOTATION: Experimental studies suggest that seasonal and experimental changes in the androgen levels of male stingrays increase their sensitivity to low frequency electric fields in the range of 0.01-4 Hz, which is specific to localized sensory afferents, and may play a role in the detection of mates.

Sisneros, J. A. and T. C. Tricas. 2002a. Ontogenetic changes in the response properties of the peripheral electrosensory system in the Atlantic stingray (*Dasyatis sabina*). *Brain Behavior and Evolution* 59:130-140.

ANNOTATION: Stimulation of the primary afferent neurons with sinusoidal 0.03 to 9.2 $\mu\text{V cm}^{-1}$ peak-to-peak electric fields shows that the peak frequency sensitivity changes during development (3–4 Hz for neonates, 4–6 Hz for juveniles, and 6–8 Hz for adults) and is approximately 4 times greater for adults than neonates.

Sisneros, J. A. and T. C. Tricas. 2002b. Neuroethology and life history adaptations of the elasmobranch electric sense. *Journal of Physiology-Paris* 96:379-389.

ANNOTATION: This review discusses evidence for the use of the electric sense by elasmobranch fishes (sharks and rays) for biological functions in addition to the well documented function of prey detection. Functions including identification of conspecifics and predators, and communication with conspecifics are discussed. Use of the electric sense in courtship, reproduction and other social interactions as well for predator avoidance is reviewed. Ontogenetic and seasonal variation in the sensitivity of the elasmobranch electric sense relative to biological functions is also discussed.

Sisneros, J. A., T. C. Tricas, and C. A. Luer. 1998. Response properties and biological function of the skate electrosensory system during ontogeny. *Journal of Comparative Physiology a-Sensory Neural and Behavioral Physiology* 183:87-99.

ANNOTATION: This study investigated the electrosensory system of the clear nose skate (*Raja erlantheria*) during three developmental stages [pre-hatch embryo (8 to 11 weeks), post-hatch

juvenile (1 to 8 months), and adult (>2 years)]. This is the first paper to report differences in the sensitivity of skates to electric stimuli as a function of developmental stage. Optimal response frequencies were 1 to 2 Hz for embryos, 5 Hz in juveniles, and 2 to 3 Hz in adults. The range of sensitivity frequency was between 0.5 and 7 Hz. The authors suggest that response properties correspond to life-history dependent functions. For example, the study demonstrated that embryos (in encapsulated egg cases) exhibit a "freeze response", halting ventilatory movements when presented with weak uniform fields at 0.5 and 1 Hz. This suggests that embryos detect and respond to electric stimuli from natural fish predators. The authors also note that electric organ discharge frequencies of adult skates match the peak frequency sensitivity of adults' electrosensory systems to facilitate electric communication during social behavior. Electric field stimuli in the range of 10-30 Hz stimulated electric organ discharge in adult skates. The authors also report that afferent nerve discharges were excited by cathodal stimuli and inhibited by anodal stimuli.

Tricas, T. C. 1982. Bioelectric-mediated predation by swell sharks, *Cephaloscyllium ventriosum*. *Copeia*:948-952.

ANNOTATION: Swell sharks (*Cephaloscyllium ventriosum*) were shown to display feeding responses to fish under natural conditions and it was shown that the response was determined by the electric field from the fish. Chambers surrounding the prey fish that blocked the electric field prevented feeding responses.

Tricas, T. C. 2001. The neuroecology of the elasmobranch electrosensory world: Why peripheral morphology shapes behavior. Pages 77-92.

ANNOTATION: The study describes the orientation of ampullary receptors in the body of skates and sharks that might relate to the detection of both electric fields and electric fields induced by movement in a DC magnetic field. The author cautions, however, that "There are currently a number of models which propose that elasmobranch fishes can use the ampullary electrosense to detect induced fields derived from the earth's magnetic field (Kalmijn 1974, 1984, 1997, Paulin 1995). Extensive field work has shown that sharks in open waters can make large scale directed movements in the absence of visual bottom landmarks (Sciarrotta & Nelson 1977, Carey & Scharrold 1990, Klimley 1993). However, well-designed, replicated and reviewed experiments are needed to demonstrate that these theories actually model what elasmobranchs do in the field." (p. 90)

Tricas, T. C. and J. E. McCosker. 1984. Predatory behavior of the white shark, *Carcharodon carcharias*, and notes on its biology. *Proceedings of the California Academy of Science* 43:221-238.

ANNOTATION: The authors present observational data suggesting that white shark attack prey associated with pulsed DC fields rather than static DC fields.

Tricas, T. C., S. W. Michael, and J. A. Sisneros. 1995. Electrosensory optimization to conspecific phasic signals for mating. *Neuroscience Letters* 202:129-132.

ANNOTATION: Results of investigations into use of the electric sense to identify conspecifics in the round stingray (*Urolophus halleri*) are presented in this paper. Attraction of stingrays to synthesized fields (peak current 8 μ A) showed that both males and females use the electric sense to identify buried females. Electrosensory optimization to conspecific phasic signals was also demonstrated. This study demonstrated the importance of electroreception to elasmobranch social behavior.

Tricas, T. C. and J. G. New. 1998. Sensitivity and response dynamics of elasmobranch electrosensory primary afferent neurons to near threshold fields. *Journal of Comparative Physiology a-Neuroethology Sensory Neural and Behavioral Physiology* 182:89-101.

ANNOTATION: Thresholds for responses of primary afferents ranged from 40 μ V cm⁻¹ PTP to several μ V cm⁻¹ PTP. All recorded units showed an increase in peak discharge to increased intensity of electrical stimulation. The maximum sensitivity to stimulation was at 1 Hz.

Tricas, T. C. and J. A. Sisneros. 2004. Ecological functions and adaptations of the elasmobranch electrosense. Pages 308-329 *in* G. von der Emde, J. Mogdans, and B. G. Kapoor, editors. *The Senses of Fish: Adaptations for the Reception of Natural Stimuli*. Narosa Publishing House, New Delhi.

ANNOTATION: This chapter reviews the biological functions of the elasmobranch electrosense. The evolution of the electrosense and the selective pressures involved are discussed. The morphology and physiology of the ampullae of Lorenzini are reviewed. Natural stimuli and behavioral responses as well as ecological functions of the electric sense ranging from prey detection and predator avoidance to social interactions with conspecifics are covered. Ontogenetic and seasonal changes in these functions are also discussed.

Tsong, T. Y. 1994. Exquisite sensitivity of electroreceptor in skates. *Biophysical Journal* 67:1367-1368.

ANNOTATION: This paper comments on the study by Lu and Fishman 1994 with the argument that periodic signals are unlikely to be masked by noise signals.

Whitehead, D. L. 2002. Ampullary organs and electroreception in freshwater *Carcharhinus leucas*. *Journal of Physiology-Paris* 96:391-395.

ANNOTATION: Experimental studies demonstrated that the freshwater shark, *Carcharhinus leucas*, response orients to low voltage stimuli <10 microamps.

Wueringer, B. E. and I. R. Tibbetts. 2008. Comparison of the lateral line and ampullary systems of two species of shovelnose ray. *Reviews in Fish Biology and Fisheries* 18:47-64.

ANNOTATION: This reference appears to not be primarily relevant to identifying species in US waters with potential sensitivity to EMFs, or to understanding potential impacts. Nonetheless, it may provide useful supporting information, and has therefore been included in the database.

Wueringer, B. E., I. R. Tibbetts, and D. L. Whitehead. 2009. Ultrastructure of the ampullae of Lorenzini of *Aptychotrema rostrata* (Rhinobatidae). *Zoomorphology* 128:45-52.

ANNOTATION: This reference appears to not be primarily relevant to identifying species in US waters with potential sensitivity to EMFs, or to understanding potential impacts. Nonetheless, it may provide useful supporting information, and has therefore been included in the database.

Yano, K., H. Mori, K. Minamikawa, S. Ueno, S. Uchida, K. Nagai, M. Toda, and M. Masuda. 2000. Behavioral Response of Sharks to Electric Stimulation. *Bulletin of Seikai National Fisheries Research Institute* 78:13-30.

ANNOTATION: The purpose of this study was to investigate the behavioral responses of multiple species of captive sharks to electrical field pulses. Results showed that behavioral responses varied with species. Stimuli were comprised of a sine wave (1-10 V and 0.1-2.5 A) and D.C. probe (0.2-10V and 0.1-5A). In the first electrical field experiment with three species, *C. falciformis* and *T. obesus* responded to the stimuli by immediately turning around in the tank and *S. fasciatum* did not change direction in response to the signal. In the second experiment using eight species, the following species elicited a strong response to the signal: *C. melanopterus*, *C. falciformis*, *T. obesus*, and *T. scyllium*; and the following species showed a weak response: *C. isabellum*, and *S. torazame*. *G. cuvier* and *S. fasciatum* did not show any response to the signal.

Appendix A-5 Elasmobranchs – Magnetic Sense

Akoev, G. N., B. Ilyinski, and P. M. Zadan. 1976. Responses of electroreceptors (ampullae of Lorenzini) of skates to electric and magnetic fields. *Journal of Comparative Physiology A* 106:127-136.

ANNOTATION: This study was conducted on two species of skates and recorded neuron impulses from single axons in the electrosensory nerve that conveys information from the ampullae of Lorenzini to the brain. Neurons responded to both applied electric and magnetic field stimuli. The ampullary receptors responded to changing magnetic stimuli at a rate of change between 0.8 and 20 Gs/sec, but did not sustain the response under a constant magnetic stimulus. Responses to magnetic stimulation were dependent upon ampullary canal length and stimulus direction. This study provides physiological evidence that the ampullary electrosensory system can detect and encode information about magnetic stimuli.

Andrianov, G. N., H. R. Brown, and B. Ilyinski. 1974. Responses of central neurons to electrical and magnetic stimuli of the ampullae of Lorenzini in the black sea skate. *Journal of Comparative Physiology A* 93:287-299.

ANNOTATION: This study investigated the response of neurons in the brain of a skate to electric and magnetic stimuli. Evoked potentials showed marked phasic responses to excitatory and inhibitory stimuli. They were sensitive to stimulus polarity. Four main patterns of responses to electric stimuli were identified. Neurons responded to changing magnetic fields, were direction dependent, were sensitive to the rate of change of the field and showed a response threshold of 2 Gs/sec. Neurons did not respond to a constant magnetic field stimulus. The authors conclude that perception of the earth's magnetic field by the skate is possible.

Brown, H. R., G. N. Andrianov, and O. B. Ilyinsky. 1974. Magnetic field perception by electroreceptors in Black Sea skates. *Nature* 249:178-179.

ANNOTATION: This brief note discusses the potential for elasmobranchs to detect the earth's magnetic field via electroreceptors.

Brown, H. R. and O. B. Ilyinsky. 1978. Ampullae of Lorenzini in magnetic field. *Journal of Comparative Physiology* 126:333-341.

ANNOTATION: The authors report that the response of electroreceptor ampullae (in Black Sea skate, *Raja clavata*) was linearly related to the rate of change of the magnetic field (dB/dt). The effective induced potential was approximately 0.35 G. The threshold of the induced electric field was 0.16 mV/cm.

Gill, A. B., Y. Huang, I. Gloyne-Phillips, J. Metcalfe, V. Quayle, J. Spencer, and V. Wearmouth. 2009. COWRIE 2.0 Electromagnetic Fields (EMF) Phase 2: EMF-sensitive fish response to EM emissions from sub-sea electricity cables of the type used by the offshore renewable energy industry. COWRIE Ltd. COWRIE-EMF-1-06. 128 pp.

ANNOTATION: A mesocosm study was conducted to determine whether electromagnetically sensitive fish respond to EMFs of the type and magnitude generated by offshore wind farm transmission cables. Three elasmobranch species were studied: The benthic Thornback Ray (*Raja clavata*), the freeswimming Spurdog (*Squalus acanthias*) and benthic Small-spotted Catshark/Lesser-spotted Dogfish (*Scyliorhinus canicula*). Responses were reported for the benthic species, thornback Ray and small-spotted Catshark.

EMF measurements were made at transmission cables of existing wind projects. The North Hoyle windfarm was the first major UK offshore windfarm with a capacity of 90 MW and began operation in 2004. The Burbo Bank windfarm, also with a 90 MW capacity, is located nearby and began operation in 2007. Power is transmitted 9 - 10 km to shore locations over 36kV XLPE armored cables. Gill et al. (2009) reports on measurements of electric and magnetic fields near the underwater cables.

Gill, A. B. and A. A. Kimber. 2005. The potential for cooperative management of elasmobranchs and offshore renewable energy development in UK waters. *Journal of the Marine Biological Association of the United Kingdom* 85:1075-1081.

ANNOTATION: This paper reviews potential impacts to elasmobranchs in UK waters from offshore renewable energy projects and suggests cooperative management strategies for elasmobranch conservation and offshore renewable energy development (ORED). Impacts related to EMF are reviewed and discussed.

Hodson, R. B. 2000. Magnetoreception in the short-tailed stingray, *Dasyatis brevicaudata*. Thesis. University of Auckland, Auckland, New Zealand.

ANNOTATION: This unpublished Master's thesis tested the ability of the stingray to detect applied magnetic field stimuli in laboratory conditions. Free swimming stingrays were conditioned to respond to an applied magnetic field. Non-magnetic brass bars were placed in the nasal cavities of the stingrays and did not impair their ability to discriminate a magnetic stimulus. When magnetite bars were placed in the nasal cavities, stingrays did not respond to the applied magnetic stimulus, thus indicating that their magnetosensory system in the olfactory region may have been impaired.

Johnsen, S. and K. J. Lohmann. 2008. Magnetoreception in animals. *Physics Today* 61:29-35.

ANNOTATION: An excellent non-technical overview of mechanisms, including that of elasmobranchs. It states that elasmobranchs are generally incapable of responding strictly to DC stimuli.

Kalmijn, A. 1984. Theory of electromagnetic orientation: a further analysis. Pages 525-564 in L. Bolis, R. D. Keynes, and S. H. O. Maddess, editors. *Comparative Physiology of Sensory Systems* Cambridge University Press, Cambridge.

ANNOTATION: This review provides a very clear discussion of the physics underlying potential mechanisms by which elasmobranchs may actively and passively detect magnetic and electric fields.

Kalmijn, A. J. 1981. Biophysics of geomagnetic field detection. *Ieee Transactions on Magnetics* 17:1113-1124.

ANNOTATION: The author provides a general review of the geomagnetic orientation of animals in the earth's magnetic field. This paper presents equations and models of how the movement of sharks and mud bacteria result in their orientations relative to the earth's magnetic field. Detailed physical models and empirical data on shark and rays are provided. These are compared with the movement of bacteria that swim along magnetic field lines via passive dipole alignment.

Kalmijn, A. J. 1982. Electric and magnetic-field detection in elasmobranch fishes. *Science* 218:916-918.

ANNOTATION: Electric and magnetic field detection in elasmobranch fishes was investigated in field and laboratory studies. Feeding responses to dipole electric fields (5 nV/cm) designed to mimic prey were observed at sea in dogfish and blue sharks. Stingrays in laboratory experiments showed the ability to orient relative to uniform electric fields (5 nV/cm) similar to those produced by ocean currents. Dogfish attacked electrodes that produced an electric field approx 0.005 mV/cm at threshold. The ability of stingrays to detect magnetic fields was inconsistent.

Kalmijn, A. J. 2000. Detection and processing of electromagnetic and near-field acoustic signals in elasmobranch fishes. *Phil. Trans. R. Soc. B*:1135-1141.

ANNOTATION: This paper discusses similarities among the acoustic and electrical sensory modalities used by elasmobranch fishes to detect prey.

Kalmijn, A. J., I. F. Gonzalez, and M. C. McClune. 2002. The physical nature of life. *Journal of Physiology-Paris* 96:355-362.

ANNOTATION: This review discusses electro- and magnetoreception in elasmobranchs. Mechanisms and physical aspects of these senses are discussed including motional-electric principles and Einstein's special theory of relativity.

Kirschvink, J. L., M. M. Walker, and C. E. Diebel. 2001. Magnetite-based magnetoreception. *Current Opinion in Neurobiology* 11:462-467.

ANNOTATION: This review discusses evidence and mechanisms for magnetite-based magnetoreception in organisms ranging from bacteria to vertebrates. The evolution of the magnetic sense and its application for homing, orientation, and navigation is also discussed. The authors argue that magnetite crystals are the basis for magnetoreception in all organisms with this capability, including elasmobranchs.

Klimley, A. P. 1993. Highly directional swimming by scalloped hammerhead sharks, *Sphyrna Lewini*, and subsurface irradiance, temperature, bathymetry, and geomagnetic field. *Marine Biology* 117:22.

ANNOTATION: The purpose of this study was to determine the homing mechanism scalloped hammerhead sharks use. The author tagged four sharks and the results showed directional swimming for 32 minutes with only gradual changes in course. No relationship between spectral irradiance distributions, temperature, and current flow directions and swimming orientation. The author hypothesized that they followed patterns of magnetic field intensities in their migration.

Klimley, A. P., S. C. Beavers, T. H. Curtis, and S. J. Jorgensen. 2002. Movements and swimming behavior of three species of sharks in La Jolla Canyon, California. *Environmental Biology of Fishes* 63:117-135.

ANNOTATION: This study investigated swimming patterns in three species of sharks: the shortfin mako, *Isurus oxyrinchus*, great white, *Carcharodon carcharias*, and blue, *Prionace glauca*. Directional swimming was reported for all three species and the mako and great white both exhibited movements associated with bottom topography at times. The possible use of the earth's natural magnetic fields as a navigational cue that could explain these swimming behaviors is discussed at length.

McCleave, J. D., S. A. J. Rommel Jr., and C. L. Cathcart. 1971. Weak electric and magnetic fields in fish orientation. *Annals of the New York Academy of Sciences* 188:270-281.

ANNOTATION: Evidence is available for the high sensitivity of fish to electric fields but not for the ability to detect weak magnetic fields. The following fish have known electroreceptive organs and can detect the following electric levels: Gymnotidae and Mormyridae (0.03 $\mu\text{V}/\text{cm}$), small-spotted catsharks and skates (0.01 $\mu\text{V}/\text{cm}$), and bullhead sharks (30 $\mu\text{V}/\text{cm}$). The authors questioned whether migratory fish are electrosensitive or magnetosensitive.

Meyer, C. G., K. N. Holland, and Y. P. Papastamatiou. 2005. Sharks can detect changes in the geomagnetic field. *Journal of the Royal Society Interface* 2:129-130.

ANNOTATION: This study reports that sharks (sandbar shark, *Carcharhinus plumbeus*; scalloped hammerhead shark, *Sphyrna lewini*) can be trained to detect threshold DC magnetic fields at intensities of 25-100 μ T.

Molteno, T. and W. Kennedy. 2009. (submitted for publication) Navigation by Induction-based Magnetoreception in Elasmobranch Fishes. *Journal of Biophysics*.

ANNOTATION: Behavioral experiments and studies of migration suggest that several species of elasmobranchs likely use a "magnetic sense" and the geomagnetic field for navigation. The basis for this sense is unknown, and the authors model the ability of elasmobranch fishes to detect magnetic fields by an induction mechanism. The analyses suggest that further experiments are required to eliminate induction as a basis for magnetoreception.

Montgomery, J. C. and M. M. Walker. 2001. Orientation and navigation in elasmobranchs: Which way forward? *Environmental Biology of Fishes* 60:109-116.

ANNOTATION: The authors review a variety of mechanisms for orientation and navigation in elasmobranchs including the earth's geomagnetic field.

New, J. G. and T. C. Tricas. 1997. Electrorceptors and Magnetoreceptors: Morphology and Function. Pages 741-758 *in* N. Sperlakis, editor. *Cell Physiology Source Book*, 2nd ed. Academic Press, San Diego.

ANNOTATION: This book chapter reviews the morphology and function of electroreceptors and magnetoreceptors.

Öhman, M. C., P. Sigray, and H. Westerberg. 2007. Offshore windmills and the effects of electromagnetic fields on fish. *Ambio* 36:630-633.

ANNOTATION: This paper reviews potential effects on fish from electromagnetic fields from transmission cables for offshore wind parks. Magnetic fields associated with underwater electrical transmission cables are characterized. Studies investigating behavioral and physiological effects from magnetic fields on fish are reviewed and discussed.

Paulin, M. G. 1995. Electrorception and the compass sense of sharks. *Journal of Theoretical Biology* 174:325-339.

ANNOTATION: This review presents a theory that explains how an elasmobranch could use its electric sense to determine compass bearing via induced electroreceptor voltages.

Peters, R. C., L. B. M. Eeuwes, and F. Bretschneider. 2007. On the electroreception threshold of aquatic vertebrates with ampullary or mucous gland electroreceptor organs. *Biological Reviews* 82:361-373.

ANNOTATION: This paper reviews and reinterprets results of research on the electric sense in aquatic organisms with ampullary organs. The authors report that the lower detection limit for marine fish is 1 nV/cm (with angular movements) to 20 nV/cm. The importance of angular movements for stimulation of the ampullary system is discussed. Differences in electroreception between benthic and pelagic fish species and between marine and limnic species are discussed.

Quinn, T. P. 1994. How do sharks orient at sea. *Trends in Ecology & Evolution* 9:277-278.

ANNOTATION: A commentary on the results of Klimley 1993 ("Highly directional swimming by scalloped hammerhead sharks, *Sphyrna lewini*, and subsurface irradiance, temperature, bathymetry, and geomagnetic field").

Ryan, P. R. 1981. Electroreception in blue sharks. *Oceanus* 24:42-44.

ANNOTATION: It is known that sharks detect low levels of electric fields with the ampullae of Lorenzini. The purpose of this study was to test blue sharks' behavioral responses to electrically charged (8 μ A). The field of current decreased to 5 nanovolts/cm within 24 to 30 cm from the electrodes. Of the 40 attacks, 7 were made onto the unactivated dipole, and 31 were made onto the activated dipole. These results show the blue sharks' significant preference for current-carrying electrodes/prey. Elasmobranchs may also possess an electromagnetic compass sense, receiving electrical information and also orienting to the Earth's magnetic field.

Walker, M. M., C. E. Diebel, and J. L. Kirschvink. 2007. Sensory systems neuroscience. Pages 335-374 in T. J. Hara and B. Zielinski, editors. *Sensory systems neuroscience: Fish Physiology*, v. 25. Elsevier Academic Press, Amsterdam, Netherlands; Boston, MA.

ANNOTATION: This book chapter reviews magnetoreception in fish. Topics range from an overview of the earth's magnetic field to mechanisms for magnetoreception, anatomical structures, neuroanatomy and neural responses, to use of the magnetic sense for navigation and a discussion of behavioral aspects.

Appendix A-6 Other Fishes – Electric Sense

Abalmazova, M. G. 1985. Response of bottom and pelagic fishes to electric and magnetic fields in sea water. SB. NAUCH. TR. VNIRO:112-122.

ANNOTATION: This paper reports fish behavioral responses to magnetic and electric fields. Responses of individual fishes within a shoal are compared. The author reports differing responses among individuals and also differences between demersal and pelagic species. Weak magnetic fields produced increased activity in demersal fishes and inhibited motor reaction in pelagic fishes. Abstract in English, monograph in Russian.

Akoev, G. N. and V. M. Muraveiko. 1984. Physiological-properties of lateral line receptors of the lamprey. *Neuroscience Letters* 49:171-173.

ANNOTATION: This paper reports finding two types of sensory nerve cells associated with the lateral line of the lamprey. One type reacts to electric fields (threshold 10–30 $\mu\text{V}/\text{cm}$) but not to mechanical stimuli and in the second type this pattern is reversed.

Alves-Gomes, J. A. 2001. The evolution of electroreception and bioelectrogenesis in teleost fish: a phylogenetic perspective. *Journal of Fish Biology* 58:1489-1511.

ANNOTATION: This review discusses the evolution of electroreception in teleost fish. The phylogenetic relationships of electrosensitive teleost fish are evaluated. The two basic types of electroreceptors, ampullary and tuberous, are discussed.

Basov, B. M. 1999. Behavior of Sterlet *Acipenser ruthenus* and Russian Sturgeon *A. gueldenstaedtii* in Low-Frequency Electric Fields. *Journal of Ichthyology* 39:782-787.

ANNOTATION: This study investigated behavioral responses of sturgeons (*Acipenser ruthenus* and *A. gueldenstaedtii*) to weak electric fields at low frequencies. At field intensities of 0.2-3 mV/cm and frequencies of 1.0-4.0 Hz sturgeons responded by changing their orientation and searching for the field source. At field intensities of 0.2-6 mV/cm and frequencies of 16-18 Hz sturgeons responded by exhibiting active foraging behavior in the area of the field. At field intensities of 0.2-0.5 mV/cm and frequencies of 50 Hz sturgeons also responded by changing their orientation and searching for the field source. However, at field intensities of 0.6 mV/cm and above and frequencies of 50 Hz, sturgeons exhibited an escape response.

Basov, B. M. 2007. On the electric fields of the electric mains and their perception by fresh-water fishes. *Voprosy ikhtiologii* 47:694-699.

ANNOTATION: This paper reports that electrosensitive fish species (e.g. sturgeon) may be impacted by power lines (current frequency of 50 Hz) across the Volga River (Russia). This paper is written in Russian with an abstract in English.

Bemis, W. E., E. K. Findeis, and L. Grande. 1997. An overview of Acipenseriformes. *Environmental Biology of Fishes* 48:25-72.

ANNOTATION: Primarily pertains to classification of Acipenseriformes but also discusses electroreception in the group (e.g., sturgeons and paddlefishes).

Bemis, W. E. and T. E. Hetherington. 1982. The rostral organ of *Latimeria chalumnae* - morphological evidence of an electroreceptive function. *Copeia*:467-471.

ANNOTATION: The authors argue that the rostral organ of the coelacanth (*Latimeria chalumnae*) is an electroreceptor based upon morphological evidence.

Berge, J. A. 1979. Perception of weak electric ac currents by the European eel, *Anguilla anguilla*. *Comparative Biochemistry and Physiology a-Physiology* 62:915-919.

ANNOTATION: European eel sensitivity to weak AC currents was tested in fresh and brackish water. In fresh water, voltage gradient thresholds averaged 0.97 mV/cm at 0.5 Hz to 19 mV/cm at 50 Hz with eels positioned parallel to the current, while thresholds with fish perpendicular to currents were 3.6 to 56 mV/cm. When eels were parallel to the current in fresh water, density thresholds averaged 0.31 $\mu\text{A}/\text{cm}^2$, and 0.88 $\mu\text{A}/\text{cm}^2$ in brackish water. The anterior half of eels was 4-5 times more sensitive than the posterior half.

Bodznick, D. and R. G. Northcutt. 1981. Electroreception in lampreys - evidence that the earliest vertebrates were electroreceptive. *Science* 212:465-467.

ANNOTATION: This study is the first to show that evoked potential and multiple unit responses of the lamprey indicate that it is sensitive to electrical stimulation at 20 $\mu\text{V}/\text{cm}$ ($2.2 \times 10^{-3} \mu\text{A}/\text{cm}^2$), and in some specimens reliable responses were reported at 0.1 $\mu\text{V}/\text{cm}$ ($1.1 \times 10^{-5} \mu\text{A}/\text{cm}^2$).

Bodznick, D. and D. G. Preston. 1983. Physiological characterization of electroreceptors in the lampreys *Ichthyomyzon unicuspis* and *Petromyzon marinus*. *Journal of Comparative Physiology* 152:209-217.

ANNOTATION: The threshold of lampreys to electric field stimulation was reported between 1 to 10 millivolts/cm with a frequency sensitivity less than or equal to 1 Hz. The receptors also exhibited sensitivity to mechanical stimulation.

Bowen, A. K., J. W. Weisser, R. A. Bergstedt, and F. Famoye. 2003. Response of larval sea lampreys (*Petromyzon marinus*) to pulsed DC electrical stimuli in laboratory experiments. *Journal of Great Lakes Research* 29:174-182.

ANNOTATION: The purpose of this study was to determine which electrical factors used in electrofishing were the most useful in inducing emergence from burrowed larval lamprey. Electrical factors that were tested were: five pulse frequencies, three pulse patterns, two duty-cycle levels over a range of seven voltage gradients in water temperatures of 10, 15, and 20 C and conductivities of 25, 200, and 900 $\mu\text{S}/\text{cm}$. The results showed that voltage gradients and pulse frequency significantly affected larval emergence at each temperature and conductivity tested, while duty cycle and pulse pattern did not significantly affect emergence levels. Results also indicated that 2.0 mV/cm, 3 pulses/sec, 10% duty-cycle, and 2:2 pulse pattern gave the best results.

Bullock, T. H. 1973. Seeing the world through a new sense: Electroreception in fish. *Am Sci* 61:316-325.

ANNOTATION: This review focuses on the ability of elasmobranch and certain other fish species to actively or passively detect objects and communicate with other conspecifics by means of low and high frequency bioelectric fields.

Bullock, T. H. 1982. Electroreception. *Annual Review of Neuroscience* 5:121-170.

ANNOTATION: A comprehensive review of the evolution, anatomy, physiology, and electric field detection by marine species using ampullary organs and tuberous organs.

Bullock, T. H. 1999. The future of research on electroreception and electrocommunication. *Journal of Experimental Biology* 202:1455-1458.

ANNOTATION: This editorial considers the future of research on electroreception and electrocommunication. The author predicts that additional taxa with capabilities to sense electric fields will be discovered and speculates about which groups are most likely to include electroreceptive species. The author discusses that little research has been done to investigate electroreception in invertebrates and mentions molluscs, arthropods, and annelids as potential candidate groups for future review. Much of the paper focuses on fish species. The author questions the role of weak electric organ discharges by electric fish and identifies this as an area in need of further research. One marine species mentioned in this discussion is the stargazer, a marine teleost in the family Uranoscopidae, reported as an electric species by Pickens and McFarland (1964).

Bullock, T. H. 2005. *Electroreception*. Springer Science+Business Media, Inc., New York.

ANNOTATION: This book covers topics on electroreception ranging from morphology of sensory organs and neuroanatomy of sensory systems to physiology and behavior. Electrogenesis is also covered. The focus is on electric fish including such marine species as electric skates (Rajidae), electric rays (Torpedinidae), and electric stargazers (Uranoscopidae).

Bullock, T. H., D. A. Bodznick, and R. G. Northcutt. 1983. The phylogenetic distribution of electroreception - evidence for convergent evolution of a primitive vertebrate sense modality. *Brain Research Reviews* 6:25-46.

ANNOTATION: This review discusses phylogenetic relationships among organisms capable of electroreception and the evolution of the electric sense. Electroreception is well developed in Petromyzoniformes and in all other non-teleost fishes except Holostei, and probably Myxiniiformes. "Thus Elasmobranchia, Holocephala, Dipneusti, Crossopterygii, Polypteriformes and Chondrostei have the physiological and anatomical specializations in a common form consistent with a single origin in primitive vertebrates." However, the sense was lost in ancestors of holostean and teleostean fishes, then re-immersed in four groups: Siluriformes, Gymnotiformes, Xenomystinae, and Mormyriiformes. Thus, the authors contend that evidence for convergent evolution exists.

Cameron, I. L., K. E. Hunter, and W. D. Winters. 1985. Retardation of embryogenesis by extremely low-frequency 60-hz electromagnetic-fields. *Physiological Chemistry and Physics and Medical Nmr* 17:135-138.

ANNOTATION: This study examined effects of electromagnetic fields on embryo development in Japanese killifish (*Oryzias latipes*). The fertilized fish eggs were exposed to a 60 Hz electrical field of 300 mA/m² current density, a 60 Hz magnetic field of 1.0 gauss RMS, or the combined electric plus magnetic fields for 48 hours. No gross abnormalities were observed but developmental delays occurred in embryos exposed to the magnetic field.

Chen, L., J. L. House, R. Krahe, and M. E. Nelson. 2005. Modeling signal and background components of electrosensory scenes. *Journal of Comparative Physiology a-Neuroethology Sensory Neural and Behavioral Physiology* 191:331-345.

ANNOTATION: This paper presents a computational model of electric field generation and electrosensory image or "scene" formation. This work was done to better characterize how weak signals produced by prey are differentiated from strong background noise. The knifefish (*Apteronotus albifrons*), a freshwater fish from South America, was used for this study; concepts could be applied to marine electric fish. The model provides a tool to estimate the spatial and temporal structure of electrosensory images in the natural environment.

Chung-Davidson, Y. W., M. B. Bryan, J. Teeter, C. N. Bedore, and W. M. Lia. 2008. Neuroendocrine and behavioral responses to weak electric fields in adult sea lampreys (*Petromyzon marinus*). *Hormones and Behavior* 54:34-40.

ANNOTATION: This study assessed behavioral and neuroendocrine responses of adult sea lampreys (*Petromyzon marinus*) to weak electric fields. Neuroendocrine responses demonstrated that adult males are sensitive to weak electric fields, while females are not, suggesting a possible role in reproduction. The authors compared these results to earlier studies and suggest that electrical stimuli mediate different behaviors in feeding-stage and spawning-stage sea lampreys.

Chung-Davidson, Y. W., S. S. Yun, J. Teeter, and W. M. Li. 2004. Brain pathways and behavioral responses to weak electric fields in parasitic sea lampreys (*Petromyzon marinus*). *Behavioral Neuroscience* 118:611-619.

ANNOTATION: This study assessed behavioral and brain responses of parasitic sea lampreys (*Petromyzon marinus*) to weak electric fields. Lampreys increased activity in response to cathodal fields (-0.1 to -30.0 $\mu\text{-V/cm}$), and decreased most active behaviors in response to anodal fields. Neuroendocrine responses were also demonstrated.

Claiborne, J. B. and D. H. Evans. 2006. *The physiology of fishes*. CRC, Taylor & Francis, Boca Raton, FL.

ANNOTATION: Electoreception and electrogenesis are covered in chapter 12 of this book. Topics ranging from phylogeny, to passive and active electroreception, and physiological ecology of the electric sense are covered in this chapter.

Collin, S. P. and D. Whitehead. 2004. The functional roles of passive electroreception in non-electric fishes. *Animal Biology* 54:1-25.

ANNOTATION: This review discusses passive electroreception in elasmobranchs and other fishes. Functional roles of electroreception including prey detection, identification of predators and conspecifics, and the role of electroreception in social behavior are discussed. A case study of electroreception in the omnihaline bull shark, *Carcharhinus leucas*, is presented. Various theories regarding geomagnetic orientation in fishes are also discussed.

Coombs, S., J. G. New, and M. Nelson. 2002. Information-processing demands in electrosensory and mechanosensory lateral line systems. *Journal of Physiology-Paris* 96:341-354.

ANNOTATION: This review compares structural, functional, behavioral, and information processing aspects of electrosensory and mechanosensory lateral line systems. Information processing for various electrosensitive species is discussed. The authors argue that electrosensory and mechanosensory lateral line systems are quite similar.

Enger, P. S., L. Kristensen, and O. Sand. 1976. Perception of weak electric dc currents by European eel (*Anguilla anguilla*). *Comparative Biochemistry and Physiology a-Physiology* 54:101-103.

ANNOTATION: The purpose of this study was to determine the sensitivity to weak electric currents in European eels. European eels were conditioned to exhibit bradycardia when exposed to DC electrical currents. Current thresholds averaged $0.08 \mu\text{A}/\text{cm}$, with a minimum value of $0.04 \mu\text{A}/\text{cm}^2$ in fresh water, and increased in higher salinity water to $9.5 \mu\text{A}/\text{cm}^2$. Thresholds were 2-3 times higher when the current direction was perpendicular to eels when compared to when currents were parallel to the eels. Calculated voltage gradient threshold values equaled 0.4-0.6 mV/cm.

Fields, R. D. 1982. Electoreception in the ratfish (subclass Holocephali) : anatomical, behavioral, and physiological studies. Thesis. Biological Sciences Dept., San Jose State University, San Jose, CA. 636.

ANNOTATION: This Masters Thesis covers anatomical, behavioral, and physiological aspects of electoreception in the ratfish (subclass Holocephali).

Fields, R. D., T. H. Bullock, and G. D. Lange. 1993. Ampullary sense-organs, peripheral, central and behavioral electoreception in chimeras (*Hydrolagus*, Holocephali, Chondrichthyes). *Brain Behavior and Evolution* 41:269-289.

ANNOTATION: The authors report that the ampullary sense organs of chimeras (*Hydrolagus colliei*) respond to low frequencies at approximately 5 Hz but not sustained DC electric fields. The threshold was approximately $0.2 \mu\text{V}/\text{cm}$.

Fields, R. D. and G. D. Lange. 1980. Electoreception in the ratfish (*Hydrolagus colliei*). *Science* 207:547-548.

ANNOTATION: The ability of the ampullar structures of the ratfish to detect electric fields was tested by electrical stimulation. The fish were trained to avoid the electrodes energized with DC or 5 Hz and the threshold was $<0.2 \mu\text{V}/\text{cm}$ at 4 cm from the electrodes.

Frey, A. H. and E. S. Eichert. 1988. An analytic model of the electrosensory system of the fish. *Journal of Bioelectricity* 7:1-32.

ANNOTATION: The authors of this paper developed a model of the electro-sensory system of fish that would test how environmental parameters interact with electoreceptors. The model could be used in behavioral and physiological experiments and physical modeling.

Fritsch, B., M. D. C. Decaprona, K. Wachtler, and K. H. Kortje. 1984. Neuroanatomical evidence for electroreception in lampreys. *Zeitschrift Fur Naturforschung C-a Journal of Biosciences* 39:856-858.

ANNOTATION: This paper reports on neural pathways in the lamprey, *Lampetra fluviatilis*. Patterns of anterior lateral-line afferents were investigated and compared to related taxa in which electrosensitivity has been reported. The authors conclude that lampreys are likely to possess electroreceptive capabilities.

Gibbs, M. A. 2004. Lateral line receptors: Where do they come from developmentally and where is our research going? *Brain Behavior and Evolution* 64:163-181.

ANNOTATION: This paper reviews available information on lateral line receptors, including electroreceptors, in fish. Evolution and phylogeny, morphology, and neural anatomy of electroreceptors are discussed.

Gill, A. B. and M. Bartlett. 2010. Literature review on the potential effects of electromagnetic fields and undersea noise from marine renewable energy developments on Atlantic salmon, sea trout and European eel. Scottish Natural Heritage Commissioned Report No.401. 43 pp.

ANNOTATION: The purpose of this literature review was to evaluate the potential for Atlantic salmon, sea trout, and European eel to be affected by marine wave and tidal power developments, specifically by EMF emissions from undersea cables and from underwater noise generated by the projects. Literature is available that documents that Atlantic salmon and European eel can use the geomagnetic field for orientation and direction finding during migrations. The authors inferred that, depending on location, EMFs from undersea cables and cabling orientation may interact with migrating eels (and possibly salmon), particularly in waters <20m. The biological significance of a response to EMFs could not be determined. All three species are likely to encounter EMF from undersea cables during the adult or early life stage movements through shallow coastal waters adjacent to natal rivers. The authors emphasized that actual responses to EMF fields and their ultimate significance to the species have yet to be determined.

Hofmann, M. H., M. Falk, and L. A. Wilkens. 2004. Electrosensory Brain Stem Neurons Compute the Time Derivative of Electric Fields in the Paddlefish. *Fluctuation and Noise Letters* 4.

ANNOTATION: The firing rate of electrosensory brain stem neurons to the rate of change of intensity of electric fields was reported. The responses were hypothesized to be similar to acoustic and mechano-sensory systems.

Holliman, F. M. and J. B. Reynolds. 2002. Electroshock-induced injury in juvenile white sturgeon. *North American Journal of Fisheries Management* 22:494-499.

ANNOTATION: The purpose of this study was to determine the risks of injury induced by electroshock fishing in white sturgeon. Risks of two waveforms (pulsed DC and DC) were examined in small and large sturgeon. The results indicated that the probability of hemorrhage among all sturgeon exposed to pulsed DC was greater (68%) than for those exposed to DC (10%). Large and small sturgeon had a high risk of injury (60 and 70 % respectively) when exposed to pulsed DC than compared to DC (10 and 10% respectively). The recovery rate from DC waveforms was less than 30s, and was 60 to 120 s for pulsed DC.

Kishida, R., H. Koyama, and R. C. Goris. 1988. Giant lateral-line afferent terminals in the electroreceptive dorsal nucleus of lampreys. *Neuroscience Research* 6:83-87.

ANNOTATION: The dorsal nucleus is known to mediate electroreception in lampreys. The authors of this paper discovered that both the common type (1-3 μ m) of nerve terminal, and a previously unreported type of giant nerve terminal (10-30 μ m) were found clustered at the rostral and caudal ends of the dorsal nucleus of the octavolateralis in lampreys. This discovery suggests that giant terminals are probably the terminals of the electroreceptive primary fibers.

Koyama, H., R. Kishida, R. Goris, and T. Kusunoki. 1993. Giant terminals in the dorsal octavolateralis nucleus of lampreys. *Journal of Comparative Neurology* 335:245-251.

ANNOTATION: The purpose of this study was to study the ultra structure of the giant terminals in the dorsal octavolateralis nucleus in lampreys. Results showed that the dorsal octavolateralis nucleus is a primary nucleus for electrostimuli in the medulla. Also, many chemical synapses were found around the neck of the terminal swellings.

McCleave, J. D. and J. H. Power. 1978. Influence of weak electric and magnetic-fields on turning behavior in elvers of American eel, *Anguilla rostrata*. *Marine Biology* 46:29-34.

ANNOTATION: This study was designed to follow up on experiments by Zimmerman and McCleave 1975. The elvers were exposed to a DC electric field from 10^{-2} uA cm $^{-2}$ to 10^2 uA cm $^{-2}$. In the lowest field, elvers turned more toward the cathode than the anode, but as the field strength increased elvers orientated more towards the anode than the cathode. When exposed to different vertical magnetic fields, the behavior of the elvers was unaffected by exposure to magnetic fields at less than 0.02 G, 0.54 G or 2 G. The authors conclude that the orientation of the elvers could be influenced by electric fields of the magnitude generated by major ocean current systems but not by electric fields induced by their own swimming in the geomagnetic field (less than 10^{-4} microamps cm $^{-2}$).

McCleave, J. D., S. A. J. Rommel Jr., and C. L. Cathcart. 1971. Weak electric and magnetic fields in fish orientation. *Annals of the New York Academy of Sciences* 188:270-281.

ANNOTATION: Evidence is available for the high sensitivity of fish to electric fields but not for the ability to detect weak magnetic fields. The following fish have known electroreceptive organs and can detect the following electric levels: Gymnotidae and Mormyridae (0.03 $\mu\text{V}/\text{cm}$), small-spotted catsharks and skates (0.01 $\mu\text{V}/\text{cm}$), and bullhead sharks (30 $\mu\text{V}/\text{cm}$). The authors questioned whether migratory fish are electrosensitive or magnetosensitive.

Muraveiko, V. M. 1984. Functional properties of lamprey electroreceptors. *Neurophysiology* 16:95-99.

ANNOTATION: This purpose of this study was to determine if electroreceptors in river lamprey were correlated to the polarity of an electrical stimulus and their frequency properties. Evoked potentials and responses of neurons from electric field intensities ranging from 0.1 to 20 $\mu\text{V}/\text{cm}$ in the medullae were recorded.

Pals, N., R. C. Peters, and A. A. C. Schoenhage. 1982. Local geo-electric fields at the bottom of the sea and their relevance for electrosensitive fish. *Netherlands Journal of Zoology* 32:479-494.

ANNOTATION: This paper reports on seafloor sources of EMFs and relevance to electroreceptive fish.

Peters, R. C., L. B. M. Eeuwes, and F. Bretschneider. 2007. On the electro-detection threshold of aquatic vertebrates with ampullary or mucous gland electroreceptor organs. *Biological Reviews* 82:361-373.

ANNOTATION: This paper reviews and reinterprets results of research on the electric sense in aquatic organisms with ampullary organs. The authors report that the lower detection limit for marine fish is 1 nV/cm (with angular movements) to 20 nV/cm. The importance of angular movements for stimulation of the ampullary system is discussed. Differences in electroreception between benthic and pelagic fish species and between marine and limnic species are discussed.

Pickens, P. E. and W. N. McFarland. 1964. Electric discharge and associated behaviour in the stargazer. *Animal Behaviour* 12:362-367.

ANNOTATION: This paper is a discussion of the electric discharge from the stargazer, *Astrosopus y-graecum*, during feeding. The electric discharge typically occurs during feeding, however, the function of the discharge is not known. The discharge is typically comprised of a high frequency “burst” of pulses followed after about milliseconds by a “train” of discrete pulses. The burst occurs just before or during the opening of the mouth, and is only observed if prey are captured and swallowed. The number of pulses in the train is directly related to the

length of prey and may also be related to the prey's movement in the stargazer's mouth. This electrical discharge is not used to stun prey, or in electro-echolocation, and it is not known if it is used for signaling.

Potts, W. T. W. and A. J. Hedges. 1991. Gill potentials in marine teleosts. *Journal of Comparative Physiology B-Biochemical Systemic and Environmental Physiology* 161:401-405.

ANNOTATION: All marine teleosts are descended from freshwater fish and have retained some features from these ancestors. This paper discusses one of those aspects, a blood ion concentration that is less than half that of seawater. Results show that the transepithelial potentials of multiple species range from 20 to 24 mV.

Regnart, H. C. 1931. The lower limits of perception of electric currents by fish. *Journal of the Marine Biological Association UK* 17:415-420.

ANNOTATION: At a total current of 100 mA between two plates charged to 15 V that produced a current density of 0.16 mA/cm^2 , the goldfish retreated or convulsed if facing the anode but little reaction if facing the cathode or moving transverse to the electrodes. Similar but weaker responses were reported at a current flow of 10 mA and a current density of $16 \text{ } \mu\text{A/cm}^2$. The minimum thresholds for a response of the goldfish and codlings were reported to be $5 \text{ } \mu\text{A/cm}^2$ and $15 \text{ } \mu\text{A/cm}^2$, respectively. Lower threshold were reported for codlings exposures to AC electric fields (60Hz?) producing current densities of $2 \text{ } \mu\text{A/cm}^2$. Additional studies involving the cutting of nerves indicated that the lateral organs were the electrosensitive organ.

Richardson, N. E., J. D. McCleave, and E. H. Albert. 1976. Effect of extremely low-frequency electric and magnetic-fields on locomotor activity rhythms of Atlantic salmon (*Salmo salar*) and American eels (*Anguilla rostrata*). *Environmental Pollution* 10:65-76.

ANNOTATION: The purpose of this study was to determine the effects of extremely low frequency electric and magnetic fields on the locomotor activities of Atlantic salmon and American eels. Extremely low frequency electrical and magnetic fields consisted of 60 to 75 Hz of 0.07 V/m or 0.7 V/m and 0.5 gauss respectively on alternating days or one hour for every 23 hours per day. Results showed that no changes in locomotor activities were observed in either salmon or eels indicating that these fish are not affected by extremely low frequency electric or magnetic fields.

Rommel, S. A. and J. D. McCleave. 1972. Oceanic electric-fields - perception by American eels. *Science* 176:1233-&.

ANNOTATION: American eels consistently showed conditioned cardiac bradycardia to small electric fields ($0.167 \times 10^{-2} \text{ microamperes/cm}^2$). Eels showed fewer responses in more saline

water and at lower current density in fresh water. These results indicate that eels are electro-sensitive and could use this information for orientation.

Rommel, S. A. and J. D. McCleave. 1973a. Prediction of oceanic electric-fields in relation to fish migration. *Journal Du Conseil* 35:27-31.

ANNOTATION: A predictive model for geoelectric fields in ocean currents was developed using data from cross sections of the Gulf Stream. The model predicted electric field intensities up to 0.46 $\mu\text{V}/\text{cm}$ and current densities up to 0.0175 $\mu\text{A}/\text{cm}^2$. The authors suggest that these levels are within the range of sensitivity for both American eel and Atlantic salmon, and thus these migratory fish species could use electro-orientation in their long-distance migrations.

Rommel, S. A. and J. D. McCleave. 1973b. Sensitivity of American eels (*Anguilla rostrata*) and Atlantic salmon (*Salmo salar*) to weak electric and magnetic-fields. *Journal of the Fisheries Research Board of Canada* 30:657-663.

ANNOTATION: Salmon and eels were trained to detect electric field stimuli by pairing with AC electric shocks. Electric fields perpendicular but not parallel to the body were effective. The threshold of the eels to the electric field was 0.067 mV/cm; that of salmon was 0.6 mV/cm. Condition responses to 0.5 G changes in the magnetic field were not effective in either species.

Ronan, M. 1988. Anatomical and physiological evidence for electroreception in larval lampreys. *Brain Research* 448:173-177.

ANNOTATION: This paper reports on the neuroanatomy of larval lampreys and provides physiological evidence for sensitivity to low-frequency electric fields.

Ronan, M. C. and D. Bodznick. 1986. End buds - non-ampullary electroreceptors in adult lampreys. *Journal of Comparative Physiology a-Sensory Neural and Behavioral Physiology* 158:9-15.

ANNOTATION: As indicated by experiments in this study, anatomical and physiological studies show that ampullary electroreceptor organs, characteristically found in all gnathostome fish, are not found in lamprey. Lamprey, instead, have epidermal end buds. These end buds are found on the surface of the skin on lampreys' trunk and head, although they are not visible. Larval and newly transformed adults do not have end buds, but adults are electroreceptive. This information indicates that end bud may be the form of electroreceptor only found in the final phase of the lamprey's life.

Teeter, J. H., R. B. Szamier, and M. V. L. Bennett. 1980. Ampullary electroreceptors in the sturgeon *Scaphirhynchus platyrhynchus* (Rafinesque). *Journal of Comparative Physiology* 138:213-223.

ANNOTATION: This study reports a linear relationship between afferent nerve discharge and electric field intensity for electric fields above a threshold over approx 0.2 mV. Higher intensity electric fields of 2 – 10 mV anodal or 50 - 150 mV cathode blocked the afferent nerve discharge.

Vriens, A. and F. Bretschneider. 1979. Electrosensitivity of the lateral line of the European eel, *Anguilla anguilla* L. *Journal De Physiologie* 75:341-342.

ANNOTATION: The authors found through conditioning experiments that European eels are slightly sensitive to electric currents with threshold current densities of approximately 1×10^{-6} A/cm².

Westerberg, H. 2000. Effect of HVDC cables on eel orientation. Pages 70-76 in *Technische Eingriffe in marine Lebensraume*. Bundesamtes für Naturschutz, Germany.

ANNOTATION: This paper summarizes results from a study on the effects of HVDC cable on European eel (*Anguilla anguilla*) migration. Several individuals veered while passing over an electrified cable in a manner consistent with a response to the cable's magnetic field. Overall, eels were not impeded from crossing the cable, and the author concluded "There is no indication that a cable constitutes a permanent obstacle for migration, neither for the adult eel nor for elvers."

Westerberg, H. and I. Lagenfelt. 2008. Sub-sea power cables and the migration behaviour of the European eel. *Fisheries Management and Ecology* 15:369–375.

ANNOTATION: This study examined the effect of a sub-sea 130 kV AC power cable on migrating European eel, *Anguilla anguilla* (L.) in the Baltic Sea. Sixty eels were tagged with coded acoustic tags and the migration speed was measured using an array with moored receivers. The authors report that eel swimming speed was significantly lower around the cable than north or south of the cable, though details on the behaviour during passage over the cable were not reported, and possible physiological mechanisms explaining the phenomenon are unknown.

Appendix A-7 Other Fishes – Magnetic Sense

Abalmazova, M. G. 1985. Response of bottom and pelagic fishes to electric and magnetic fields in sea water. SB. NAUCH. TR. VNIRO:112-122.

ANNOTATION: This paper reports fish behavioral responses to magnetic and electric fields. Responses of individual fishes within a shoal are compared. The author reports differing responses among individuals and also differences between demersal and pelagic species. Weak magnetic fields produced increased activity in demersal fishes and inhibited motor reaction in pelagic fishes. Abstract in English, monograph in Russian.

Able, K. P. 1991. Common themes and variations in animal orientation systems. *American Zoologist* 31:157-167.

ANNOTATION: A general review of animal orientation systems with a limited discussion of salmon.

Bochert, R. and M. L. Zettler. 2004. Long-term exposure of several marine benthic animals to static magnetic fields. *Bioelectromagnetics* 25:498-502.

ANNOTATION: The prawn, crab, isopod, flounder, and mussels were allocated to groups exposed to 3.7 mT DC magnetic fields or control conditions for up to seven weeks. No differences in longevity were observed. Further observations of mussels for fitness and gonadal development did not reveal differences between exposed and control groups. The DC magnetic field intensity was selected to simulate maximum exposures to magnetic fields from DC undersea cables in the Baltic Sea.

Branover, G. G., A. S. Vasil'yev, S. I. Gleyzer, and A. B. Tsinober. 1971. A study of the behavior of the eel in natural and artificial and magnetic fields and an analysis of its reception mechanism. *J. Ichthyol. (Vopr. Ikhtiolog. Eng. Ed.)* 11:608-614.

ANNOTATION: Multiple laboratory experiments have shown that young eels are able to sense magnetic fields and use this information for direction of movement. This paper discusses a theory by which this information is received, the magnetohydrodynamic mechanism.

Cameron, I. L., K. E. Hunter, and W. D. Winters. 1985. Retardation of embryogenesis by extremely low-frequency 60-hz electromagnetic-fields. *Physiological Chemistry and Physics and Medical Nmr* 17:135-138.

ANNOTATION: This study examined effects of electromagnetic fields on embryo development in Japanese killifish (*Oryzias latipes*). The fertilized fish eggs were exposed to a 60 Hz electrical field of 300 mA/m² current density, a 60 Hz magnetic field of 1.0 gauss RMS, or the combined

electric plus magnetic fields for 48 hours. No gross abnormalities were observed but developmental delays occurred in embryos exposed to the magnetic field.

Diebel, C. E., R. Proksch, C. R. Green, P. Neilson, and M. M. Walker. 2000. Magnetite defines a vertebrate magnetoreceptor. *Nature* 406:299-302.

ANNOTATION: The authors report the anatomic location and identification of magnetite crystals in the olfactory lamellae of rainbow trout.

Dittman, A. H. and T. P. Quinn. 1996. Homing in Pacific salmon: Mechanisms and ecological basis. *Journal of Experimental Biology* 199:83-91.

ANNOTATION: This paper reviews homing mechanisms in Pacific salmon. The authors note that juvenile salmon are able to orient to the earth's magnetic field. The authors also discuss that biogenic magnetite crystals have been isolated from the head or lateral line of several salmon species. These crystals may be used for magnetoreception; but it is not known how a magnetic sense may be integrated with other orientation systems, and it remains to be demonstrated whether magnetoreception is used for navigation to guide ocean migrations.

Formicki, K., M. Sadowski, A. Tanski, A. Korzelecka-Orkisz, and A. Winnicki. 2004. Behaviour of trout (*Salmo trutta* L.) larvae and fry in a constant magnetic field. *Journal of Applied Ichthyology* 20:290.

ANNOTATION: Permanent magnets producing fields between 0.15 – 4.2 mT were reported to increase the preference of trout for chambers in a maze.

Formicki, K. and A. Winnicki. 1998. Reactions of fish embryos and larvae to constant magnetic fields. *Italian Journal of Zoology* 65:479.

ANNOTATION: DC magnetic fields above 4 mT were reported to slow embryonic development and produce heavier and longer embryos. No statistical analysis was presented. Magnetic fields also were reported to increase heart rate but no data were presented. Magnetic field intensities between 0.5 and 1.0 mT were reported to produce qualitative changes in embryo orientation.

Garg, T. K., N. Agarwal, and S. Rai. 1995. Effect of Magnetically Restructured Water on the Liver of a Catfish *Clarias Batrachus*. *Electro- and Magnetobiology* 14.

ANNOTATION: This study reports that fish exposed to magnetically-treated water for 4 days produced cellular changes in the liver, although there was no control for the release of toxic metal ions from the magnets into the water. The investigators did report that the toxicity was different depending on which pole of the magnet was in the water.

Gertseva, V. V. and V. I. Gertsev. 2002. A model of fish population distribution in the space of inhabitation. *Ecological Modelling* 147:161-170.

ANNOTATION: This study describes a model of fish population distribution. The model is applied to sturgeon in the Volga river (Russia), and is used to illustrate an influence of the magnetic field from an electrical transmission line on the distribution of sturgeon during spawning migrations. The authors indicate that "...the stronger the magnetic field is, the faster sturgeon try to leave the area affected by it." The authors do not elaborate on their methods used to study sturgeon distribution relative to power transmission lines.

Gill, A. B. and M. Bartlett. 2010. Literature review on the potential effects of electromagnetic fields and undersea noise from marine renewable energy developments on Atlantic salmon, sea trout and European eel. Scottish Natural Heritage Commissioned Report No.401. 43 pp.

ANNOTATION: The purpose of this literature review was to evaluate the potential for Atlantic salmon, sea trout, and European eel to be affected by marine wave and tidal power developments, specifically by EMF emissions from undersea cables and from underwater noise generated by the projects. Literature is available that documents that Atlantic salmon and European eel can use the geomagnetic field for orientation and direction finding during migrations. The authors inferred that, depending on location, EMFs from undersea cables and cabling orientation may interact with migrating eels (and possibly salmon), particularly in waters <20m. The biological significance of a response to EMFs could not be determined. All three species are likely to encounter EMF from undersea cables during the adult or early life stage movements through shallow coastal waters adjacent to natal rivers. The authors emphasized that actual responses to EMF fields and their ultimate significance to the species have yet to be determined.

Haugh, C. V. and M. M. Walker. 1998. Magnetic discrimination learning in rainbow trout (*Oncorhynchus mykiss*). *Journal of Navigation* 51:35-45.

ANNOTATION: This paper demonstrated that four rainbow trout can learn to discriminate between the presence or absence of magnetic field intensity anomalies (peak intensity of 75 [μ]Tesla). The trout were trained to strike a target at the end of a response bar for a food reward.

Karlsson, L. 1985. Behavioral-responses of European silver eels (*Anguilla anguilla*) to the geomagnetic-field. *Helgolander Meeresuntersuchungen* 39:71-81.

ANNOTATION: Magnetic orientation in silver eels was tested in a laboratory tank. The eels as a group did not appear to prefer any particular swim direction in the tank. Orientation of

individual eels was however significantly different between the two magnetic fields. These results indicate that eels do respond to geomagnetic fields.

Lohmann, K. J., N. F. Putman, and C. M. F. Lohmann. 2008a. Geomagnetic imprinting: A unifying hypothesis of long-distance natal homing in salmon and sea turtles. *Proceedings of the National Academy of Sciences of the United States of America* 105:19096-19101.

ANNOTATION: The hypothesis presented is that some populations of salmon and sea turtles that migrate long distances imprint on the magnetic signature of their birth place, but that non-magnetic local cues are more important in pinpointing nesting and spawning areas.

Mann, S., N. H. C. Sparks, M. M. Walker, and J. L. Kirschvink. 1988. Ultrastructure, morphology and organization of biogenic magnetite from sockeye salmon, *Oncorhynchus nerka* - implications for magnetoreception. *Journal of Experimental Biology* 140:35-49.

ANNOTATION: This paper reports on the ultrastructure, morphology, and organization of ferromagnetic material in the sockeye salmon, *Oncorhynchus nerka*.

McCleave, J. D. and J. H. Power. 1978. Influence of weak electric and magnetic-fields on turning behavior in elvers of American eel, *Anguilla rostrata*. *Marine Biology* 46:29-34.

ANNOTATION: This study was designed to follow up on experiments by Zimmerman and McCleave 1975. The elvers were exposed to a DC electric field from 10^{-2} uA cm⁻² to 10^2 uA cm⁻². In the lowest field, elvers turned more toward the cathode than the anode, but as the field strength increased elvers orientated more towards the anode than the cathode. When exposed to different vertical magnetic fields, the behavior of the elvers was unaffected by exposure to magnetic fields at less than 0.02 G, 0.54 G or 2 G. The authors conclude that the orientation of the elvers could be influenced by electric fields of the magnitude generated by major ocean current systems but not by electric fields induced by their own swimming in the geomagnetic field (less than 10^{-4} microamps cm⁻²).

McCleave, J. D., S. A. J. Rommel Jr., and C. L. Cathcart. 1971. Weak electric and magnetic fields in fish orientation. *Annals of the New York Academy of Sciences* 188:270-281.

ANNOTATION: Evidence is available for the high sensitivity of fish to electric fields but not for the ability to detect weak magnetic fields. The following fish have known electroreceptive organs and can detect the following electric levels: Gymnotidae and Mormyridae (0.03 μV/cm), small-spotted catsharks and skates (0.01μV/cm), and bullhead sharks (30 μV/cm). The authors questioned whether migratory fish are electrosensitive or magnetosensitive.

Metcalfe, J. D., B. H. Holford, and G. P. Arnold. 1993. Orientation of plaice (*Pleuronectes platessa*) in the open sea - evidence for the use of external directional clues. *Marine Biology* 117:559-566.

ANNOTATION: The authors observed that six tagged plaice (*Pleuronectes platessa*) displayed a constant heading during the night suggesting orientation to an external magnetic cue. The paper notes that Metcalfe (unpublished) was unable to detect magnetite in either the ethmoid or lateral line tissues of eight adult plaice that were examined.

Moore, A., S. M. Freake, and I. M. Thomas. 1990. Magnetic particles in the lateral line of the Atlantic salmon (*Salmo salar* L.). *Philosophical Transactions of the Royal Society of London Series B-Biological Sciences* 329:11-15.

ANNOTATION: The authors discuss magnetite particles in the Atlantic salmon and examine their magnetic properties. This is the first report of magnetic material associated with a receptor system in a migratory teleost fish. The authors suggest that the magnetite particles may have a role in navigation using the geomagnetic field during open-sea migrations.

Moore, A. and W. D. Riley. 2009. Magnetic particles associated with the lateral line of the European eel *Anguilla anguilla*. *Journal of Fish Biology* 74:1629-1634.

ANNOTATION: This study reports the concentrations of magnetic material in the region of the lateral line system the European eel *Anguilla anguilla*, which is consistent with the hypothesis that magnetite or a similar ferromagnetic material is involved in the detection of DC magnetic fields. The possible use of magnetoreception to orientate with respect to the geomagnetic field during extensive oceanic spawning migrations is discussed.

Nishi, T. and G. Kawamura. 2005. *Anguilla japonica* is already magnetosensitive at the glass eel phase. *Journal of Fish Biology* 67:1213-1224.

ANNOTATION: The glass eel stage of Japanese eels were conditioned to magnetic field intensity of 192,473 nT in order to test their magnetosensitivity. All glass eels tested responded with bradycardia to 192,473 nT and 12,663 nT magnetic fields that combined with geomagnetic field of 32,524 nT at the laboratory and produced a magnetic field of 21° east. These results suggest that glass eels are highly magnetosensitive, and are likely so early in life. A current hypothesis is that silver-phase adult eels migrate back to the ocean spawning grounds by reversing the geomagnetic information learned from the glass-eel phase of the migration from the ocean to coastal waters.

Nishi, T. and G. Kawamura. 2006. Magnetosensitivity in the darkbanded rockfish *Sebastes inermis*. *Nippon Suisan Gakkaishi* 72:27-33.

ANNOTATION: Magnetosensitivity in the darkbanded rockfish was investigated by conditioning and electrocardiography. The abstract reports that the classical conditioning response to aversive light stimuli could be triggered by small changes in the orientation of the geomagnetic field. The authors contend that their results indicate that darkbanded rockfish have a magnetic sense and could likely navigate using the geomagnetic field. Japanese text.

Nishi, T., G. Kawamura, and K. Matsumoto. 2004. Magnetic sense in the Japanese eel, *Anguilla japonica*, as determined by conditioning and electrocardiography. *Journal of Experimental Biology* 207:2965-2970.

ANNOTATION: Classical conditioning studies suggest that the Japanese eel is sensitive to small changes in the geomagnetic field. The authors discuss why these results are different than some early results reported for European and American eel which did not suggest a sensitivity to the geomagnetic field; they suggest that differences may be explained by different experimental methodologies.

Nishi, T., G. Kawamura, and S. Sannomiya. 2005a. Anosmic Japanese eel *Anguilla japonica* can no longer detect magnetic fields. *Fisheries Science* 71:101-106.

ANNOTATION: Eels rendered anosmic (unable to perceive odors) did not respond to the geomagnetic field as evidenced by conditioned slowing of the heart rate.

Öhman, M. C., P. Sigra, and H. Westerberg. 2007. Offshore windmills and the effects of electromagnetic fields on fish. *Ambio* 36:630-633.

ANNOTATION: This paper reviews potential effects on fish from electromagnetic fields from transmission cables for offshore wind parks. Magnetic fields associated with underwater electrical transmission cables are characterized. Studies investigating behavioral and physiological effects from magnetic fields on fish are reviewed and discussed.

Quinn, T. P. 1980. Evidence for celestial and magnetic compass orientation in lake migrating sockeye salmon fry. *Journal of Comparative Physiology* 137:243-248.

ANNOTATION: The compass orientation of juvenile sockeye salmon was maintained after removal from the river at night and under cover. A 90 degree change in the horizontal component of the earth's magnetic field changed the direction of the fry at night. This response was not seen in the daytime.

Quinn, T. P. and E. L. Brannon. 1982. The use of celestial and magnetic cues by orienting sockeye salmon smolts. *Journal of Comparative Physiology* 147:547-552.

ANNOTATION: A 90 degree rotation of the horizontal component of the geomagnetic field did not change the orientation of salmon smolts with the open sky. In contrast, with cover over the tanks, change in the magnetic field changed the orientation of the smolts.

Quinn, T. P. and C. Groot. 1983. Orientation of chum salmon (*Oncorhynchus keta*) after internal and external magnetic-field alteration. *Canadian Journal of Fisheries and Aquatic Sciences* 40:1598-1606.

ANNOTATION: The purpose of this study was to test chum salmon's response in swim direction from internal and external magnets. Before magnets were installed, the salmon's swim direction in the tanks coincided with that of a typical migration. In the lab, stainless steel coded wire tags were inserted in to the salmon's heads (some were magnetized and control tags were nonmagnetized). Salmon fry orientation was not affected by either magnetized or nonmagnetized internal tags. A change in directional movements was observed with a 90° change in the external magnets, however neither magnitude nor direction were explainable.

Quinn, T. P. and C. Groot. 1984. Pacific salmon (*Oncorhynchus*) migrations - orientation versus random movement. *Canadian Journal of Fisheries and Aquatic Sciences* 41:1319-1324.

ANNOTATION: This paper reexamines the (Saila and Shappy 1963) computer simulation that indicated that only a slight homing orientation is used in Pacific salmon in their migration from the open ocean to coastal waters. Assumptions made by (Saila and Shappy 1963) of swim speed, duration of migration, and return success were incorrect, which led to an underestimation of Salmon's homing orientation. This paper emphasizes that salmon have strong homing orientation behavior.

Quinn, T. P., R. T. Merrill, and E. L. Brannon. 1981. Magnetic field detection in sockeye salmon. *Journal of Experimental Zoology* 217:137-142.

ANNOTATION: The study failed to detect magnetic material in sockeye salmon that could not be attributed to environmental contamination. Reversal of the vertical component of the geomagnetic field did not cause a 180 degree change in the orientation of the salmon fry and the results were interpreted as showing that the fry primarily orient to the horizontal component of the geomagnetic field.

Quinn, T. P. and J. C. Ogden. 1984. Field evidence of compass orientation in migrating juvenile grunts (*Haemulidae*). *Journal of Experimental Marine Biology and Ecology* 81:181-192.

ANNOTATION: In this study, grunts were captured and taken to a distant release site to investigate compass orientation as a mechanism involved in daily migrations of these reef fishes. The authors conclude that grunts appear to utilize a compass system and mention magnetic orientation as one possible mechanism to explain this capability.

Richardson, N. E., J. D. McCleave, and E. H. Albert. 1976. Effect of extremely low-frequency electric and magnetic-fields on locomotor activity rhythms of Atlantic salmon (*Salmo salar*) and American eels (*Anguilla rostrata*). *Environmental Pollution* 10:65-76.

ANNOTATION: The purpose of this study was to determine the effects of extremely low frequency electric and magnetic fields on the locomotor activities of Atlantic salmon and American eels. Extremely low frequency electrical and magnetic fields consisted of 60 to 75 Hz of 0.07 V/m or 0.7 V/m and 0.5 gauss respectively on alternating days or one hour for every 23 hours per day. Results showed that no changes in locomotor activities were observed in either salmon or eels indicating that these fish are not affected by extremely low frequency electric or magnetic fields.

Rommel, S. A. and J. D. McCleave. 1973b. Sensitivity of American eels (*Anguilla rostrata*) and Atlantic salmon (*Salmo salar*) to weak electric and magnetic-fields. *Journal of the Fisheries Research Board of Canada* 30:657-663.

ANNOTATION: Salmon and eels were trained to detect electric field stimuli by pairing with AC electric shocks. Electric fields perpendicular but not parallel to the body were effective. The threshold of the eels to the electric field was 0.067 mV/cm; that of salmon was 0.6 mV/cm. Condition responses to 0.5 G changes in the magnetic field were not effective in either species.

Sadowski, M., A. Winnicki, K. Formicki, A. Sobocinski, and A. Tanski. 2007. The effect of magnetic field on permeability of egg shells of salmonid fishes. *Acta ichthyologica et piscatoria* 37:129-135.

ANNOTATION: DC magnetic fields were reported to increase the permeability of eggs to water and isolated cells in hypertonic solutions that were accompanied by morphological changes.

Strand, J. A., C. S. Abernethy, J. R. Skalski, and R. G. Genoway. 1983. Effects of magnetic field exposure on fertilization success in rainbow trout, *Salmo gairdneri*. *Bioelectromagnetics* 4:295-301.

ANNOTATION: The purpose of this study was to determine the effects of rainbow trout eggs and sperm (separately from each other and together) to 1-T magnetic fields in the laboratory. Eggs and sperm exposed to the magnetic field both separately and together showed significant enhancement in fertilization.

Tanski, A., K. Formicki, A. Korzelecka-Orkisz, and A. Winnicki. 2005. Spatial Orientation of Fish Embryos in Magnetic Field. *Electronic Journal of Ichthyology* 1:14.

ANNOTATION: Spatial orientation of fish embryos exposed to artificial magnetic fields (0.5, 1.0, 2.0, and 4.0 mT) was investigated. Statistically significant orientation responses were observed.

Taylor, P. B. 1986. Experimental evidence for geomagnetic orientation in juvenile salmon, *Oncorhynchus tshawytscha* Walbaum. *Journal of Fish Biology* 28:607-623.

ANNOTATION: This study reported that a 90 degree shift in the horizontal component of the geomagnetic field shifted the orientation of the fish by approximately 56 degrees, but the surprising finding was that the response was delayed by one to three days.

Tesch, F. W. 1974. Influence of geomagnetism and salinity on directional choice of eels. *Helgolander Wissenschaftliche Meeresuntersuchungen* 26:382-395.

ANNOTATION: The purpose of this study was to determine whether silver eels respond to magnetic fields. The swimming movements of 9 male eels from the Elbe River, Hamburg, 11 male eels from the Elbe Estuary, Hamburg, and 5 female eels from Rhode Island, USA were observed for 17-24 hours in both fresh and salt water. In salt water, eels from all three locations changed their preferred swim direction from north or south to east when the geomagnetic field was 0. In fresh water, the eels also preferred more easterly directions. Sea water controls significantly preferred north or south, and freshwater control eels significantly preferred east or southeast. These results indicate that the combination of geomagnetism and salinity may be used for migratory orientation.

Ueda, K., Y. Maeda, M. Koyama, K. Yaskawa, and T. Tokui. 1986. Magnetic remanences in salmonid fish. *Bulletin of the Japanese Society of Scientific Fisheries* 52:193-198.

ANNOTATION: No relationship between migrating and non-migrating salmonid species was found in the magnetic material in the body based on measurements using a SQUID magnetometer. The magnetic resonance was 10- to 100-fold less than species such as bees, pigeons, or dolphins.

Walker, M. M. 1984. Learned magnetic field discrimination in yellowfin tuna, *Thunnus albacares*. *Journal of Comparative Physiology a-Neuroethology Sensory Neural and Behavioral Physiology* 155:673-679.

ANNOTATION: The author reports that yellowfin tuna were trained to discriminate between background magnetic fields and the magnetic fields in which the vertical component was changed by 10 to 50 microtesla.

Walker, M. M., C. E. Diebel, C. V. Haugh, P. M. Pankhurst, J. C. Montgomery, and C. R. Green. 1997. Structure and function of the vertebrate magnetic sense. *Nature* 390:371-376.

ANNOTATION: This study investigated the sensory system used by vertebrates for magnetoreception and navigation using the earth's magnetic field. Behavioral and electrophysiological responses were reported. The authors report that 50 μT increases or decreases in the magnetic field affected the firing of single neurons of the trigeminal nerve of rainbow trout. The neurons were responsive to the changes in intensity but not the direction of the magnetic field.

Walker, M. M., C. E. Diebel, and J. L. Kirschvink. 2007. Sensory systems neuroscience. Pages 335-374 in T. J. Hara and B. Zielinski, editors. *Sensory systems neuroscience: Fish Physiology*, v. 25. Elsevier Academic Press, Amsterdam, Netherlands; Boston, MA.

ANNOTATION: This book chapter reviews magnetoreception in fish. Topics range from an overview of the earth's magnetic field to mechanisms for magnetoreception, anatomical structures, neuroanatomy and neural responses, to use of the magnetic sense for navigation and a discussion of behavioral aspects.

Walker, M. M., J. L. Kirschvink, S. B. R. Chang, and A. E. Dizon. 1984. A candidate magnetic sense organ in the yellowfin tuna, *Thunnus albacares*. *Science* 224:751-753.

ANNOTATION: The authors report that a single domain magnetite crystal has been identified in the ethmoid sinus of the skull of the yellowfin tuna (*Thunnus albacares*). The authors propose that this represents a candidate magnetic sense organ for vertebrate animals.

Walker, M. M., T. P. Quinn, J. L. Kirschvink, and C. Groot. 1988. Production of single-domain magnetite throughout life by sockeye salmon, *Oncorhynchus nerka*. *Journal of Experimental Biology* 140:51-63.

ANNOTATION: This study investigated production of biogenic magnetite in various life stages of the sockeye salmon. Significant quantities of magnetite were found in the skull of adult sockeye salmon. Magnetite quantities were found to increase throughout the juvenile stages; and the authors conclude that "By the smolt stage, the amount of magnetite present in the front of the skull is sufficient to provide the fish with a magnetoreceptor capable of detecting small changes in the intensity of the geomagnetic field."

Westerberg, H. 2000. Effect of HVDC cables on eel orientation. Pages 70-76 in *Technische Eingriffe in marine Lebensraume*. Bundesamtes für Naturschutz, Germany.

ANNOTATION: This paper summarizes results from a study on the effects of HVDC cable on European eel (*Anguilla anguilla*) migration. Several individuals veered while passing over an

electrified cable in a manner consistent with a response to the cable's magnetic field. Overall, eels were not impeded from crossing the cable, and the author concluded "There is no indication that a cable constitutes a permanent obstacle for migration, neither for the adult eel nor for elvers."

Westerberg, H. and I. Lagenfelt. 2008. Sub-sea power cables and the migration behaviour of the European eel. *Fisheries Management and Ecology* 15:369–375.

ANNOTATION: This study examined the effect of a sub-sea 130 kV AC power cable on migrating European eel, *Anguilla anguilla* (L.) in the Baltic Sea. Sixty eels were tagged with coded acoustic tags and the migration speed was measured using an array with moored receivers. The authors report that eel swimming speed was significantly lower around the cable than north or south of the cable, though details on the behaviour during passage over the cable were not reported, and possible physiological mechanisms explaining the phenomenon are unknown.

Yano, A. and S. Aoyagi. 2008. TOF-SIMS analysis of magnetic materials in chum salmon head. Pages 1100-1103.

ANNOTATION: The purpose of this study was to determine if time-of-flight secondary ion mass spectrometry (TOF-SIMS) is a valid method to determine magnetoreception in fish heads. Tissue from a chum salmon head was examined for magnetic material using an ion mass spectrometer. Results showed that specific deposits of iron compounds and aggregates of iron particles were present, indicating that TOF-SIMS is a valid method for detecting magnetoreception in fish.

Yano, A., M. Ogura, A. Sato, Y. Sakaki, Y. Shimizu, N. Baba, and K. Nagasawa. 1997. Effect of modified magnetic field on the ocean migration of maturing chum salmon, *Oncorhynchus keta*. *Marine Biology* 129:523-530.

ANNOTATION: The migration behavior of four chum was tracked by ultrasonic transmitters. An electromagnetic coil attached near the back of the head produced a DC magnetic field that alternated in polarity at 11.25 minute intervals. No effect of the magnet on the horizontal or vertical movements of the chum was detected.

Zimmerman, M. A. and J. D. McCleave. 1975. Orientation of elvers of American eels (*Anguilla rostrata*) in weak magnetic and electric-fields. *Helgolander Wissenschaftliche Meeresuntersuchungen* 27:175-189.

ANNOTATION: The purpose of this study was to determine whether weak magnetic and electric fields affect orientation in American eels in an experimental tank. Eels' turning angles were the same when the horizontal vector of the earth's magnetic field was parallel to the eel, and when the horizontal vector was perpendicular to it. No changes in turning, or when the

horizontal component of the magnetic field was negated were observed. These results suggest that elvers do not directly use the Earth's magnetic field, but may use the ocean's electric field for orientation.

Appendix A-8 Marine Mammals – Electric Sense

Kvitek, R. G., C. E. Bowlby, and M. Staedler. 1993. Diet and foraging behavior of sea otters in southeast Alaska. *Marine Mammal Science* 9:168-181.

ANNOTATION: This paper discusses diet and foraging in sea otters. Electroreception is mentioned as a possible explanation (along with chemoreception) of how sea otters may detect buried prey items.

Appendix A-9 Marine Mammals – Magnetic Sense

Kirschvink, J. L., A. E. Dizon, and J. A. Westphal. 1986. Evidence from strandings for geomagnetic sensitivity in cetaceans. *Journal of Experimental Biology* 120:1-24.

ANNOTATION: The authors report a statistical association between strandings of cetaceans and minima in the geomagnetic field. The authors conclude that cetaceans possess a magnetic sensory system and that the magnetic topography may play an important role in guiding long distance migration in cetaceans.

Cain, S. D., L. C. Boles, J. H. Wang, and K. J. Lohmann. 2005. Magnetic orientation and navigation in marine turtles, lobsters, and molluscs: Concepts and conundrums. *Integrative and Comparative Biology* 45:539-546.

ANNOTATION: This review discusses the migratory behaviour of sea turtles with respect to regional geomagnetic fields, the magnetic navigation of spiny lobsters, and the neuro mechanisms underlying the orientation of *Tritonia* to DC magnetic fields. Experiments were done displacing hatchling loggerhead sea turtles to determine how they use the earth's magnetic field for migration and/or orientation. Displaced hatchlings swam in directions toward the migration route, and the authors concluded that local magnetic fields are used as navigation markers and can cause changes in swim direction at crucial geographic boundaries. Adult turtles acquired a "magnetic map" allowing them to determine their position. Magnetoreception in marine mammals, the spiny lobster (*Panulirus argus*), and the marine mollusc *Tritonia diomedea* are also discussed.

Putman, N. F. and K. J. Lohmann. 2008. Compatibility of magnetic imprinting and secular variation. *Current Biology* 18:R596-R597.

ANNOTATION: The authors compare the migration patterns of Kemps ridley turtle to variations in magnetic field over the past 400 years predicted by models. The purpose of the study was to determine whether "secular variation", or small gradual changes in the Earth's magnetic field over time, would confound the use of magnetic signatures for natal homing. The authors conclude that the magnetic imprinting hypothesis provides a plausible explanation for how marine species such as sea turtles, salmon, and elephant seals can return to their natal regions along continental coastlines after long absences (over a decade). Studies are needed to determine whether magnetic imprinting actually occurs in these species.

Hui, C. A. 1994. Lack of association between magnetic patterns and the distribution of free-ranging dolphins. *Journal of Mammalogy* 75:399-405.

ANNOTATION: An analysis of the sitings of dolphins showed no association with magnetic intensity gradients or directional orientation with magnetic patterns. The behavior of the dolphins in this study was associated only with the bottom topography.

Kuznetsov, V. B. 1999. Vegetative responses of dolphin to changes in permanent magnetic field. *Biofizika* 44:496-502.

ANNOTATION: Functional behaviors (i.e. motion, sharp exhalations, and acoustic activity) and concurrent electrocardiogram and cutaneous reactions were measured while bottlenose dolphins were exposed to various levels of permanent magnetic fields. Measurable responses were recorded from field strengths of 32, 108, and 168 μT in 79, 63, and 53% of the presentations respectively. These results indicate that dolphins are magnetoreceptive to permanent magnetic fields.

Zoeger, J., J. R. Dunn, and M. Fuller. 1981. Magnetic material in the head of the common Pacific dolphin. *Science* 213:892-894.

ANNOTATION: This study reports the discovery of magnetite in the head of a Pacific dolphin. It is the first report of magnetite in a mammal. The authors conclude that they “do not know whether the magnetite is part of a field receptor system or whether dolphins can detect a magnetic field.”

Thomas, J. A. 1990. Sensory abilities of cetaceans : laboratory and field evidence ; [proceedings of a NATO advanced research workshop and symposium of the Fifth International Theriological Congress on Sensory Abilities of Cetaceans, held August 22 - 29, 1989, in Rome Italy]. Plenum Press, New York, NY [u.a.].

ANNOTATION: These conference proceedings include two papers on magnetoreception in cetaceans. The first paper (Kirschvink) presents evidence of geomagnetic sensitivity based on live stranding records in the US. The second paper (Klinowska) discusses behavioral evidence for geomagnetic orientation.

Appendix A-10 Sea Turtles – Magnetic Sense

Akesson, S., A. C. Broderick, F. Glen, B. J. Godley, P. Luschi, F. Papi, and G. C. Rays. 2003. Navigation by green turtles: which strategy do displaced adults use to find Ascension Island? *Oikos* 103:363-372.

ANNOTATION: It is not known how turtles navigate to an isolated island Ascension Island, off Brazil. In this study, female green turtles were displaced to the NE, SE, W, and NW from their goal location of Ascension Island, and tracked using satellite tags. Results showed that these turtles did not use geomagnetic cues to locate the island, but instead used a combination of searching strategy and beaconing. The searching strategy used was swimming in large loops and sometimes returning to their release site or crossing previous tracks. The beaconing strategy used was presumably important information that was transported on the prevailing NW wind (since those that found the Island approached from the NW).

Akesson, S., P. Luschi, F. Papi, A. C. Broderick, F. Glen, B. J. Godley, and G. C. Hays. 2001. Oceanic long-distance navigation: Do experienced migrants use the Earth's magnetic field? *Journal of Navigation* 54:419-427.

ANNOTATION: This study investigated the use of geomagnetic cues for navigation during long distance migrations by albatrosses and green sea turtles. The authors reported that green turtles fitted with disturbing magnets accomplished their journey from Ascension Island in the South Atlantic Ocean to the Brazilian coast but arrived slightly south of the destination reached by control turtles.

Alerstam, T. 2006. Conflicting evidence about long-distance animal navigation. *Science* 313:791-794.

ANNOTATION: This paper is offering a discussion on the controversial nature of the current hypotheses on geomagnetic homing among animals. The author states that support exists for geomagnetic homing from North/South displacement, but not for East/West displacement. Also, it is still unknown whether geomagnetic gradients are actually available in the local, natural homing ranges of the experimental animals. There is a discussion on other cues used, like olfactory navigation used by sea turtles carried on the wind. More information is still needed regarding how animals integrate different cues used for long-distance navigation.

Alerstam, T., A. Hedenstrom, and S. Akesson. 2003. Long-distance migration: evolution and determinants. *Oikos* 103:247-260.

ANNOTATION: A review article with limited discussion of green sea turtle migration and the use of magnetoreception.

Avens, L., J. Braun-McNeill, S. Epperly, and K. J. Lohmann. 2003. Site fidelity and homing behavior in juvenile loggerhead sea turtles (*Caretta caretta*). *Marine Biology* 143:211-220.

ANNOTATION: Site fidelity and homing behavior in juvenile loggerhead sea turtles (*Caretta caretta*) was investigated through displacement experiments. The authors conclude that "...juvenile loggerheads exhibit fidelity to specific areas during summer months and possess the navigational abilities to home to these areas following forced displacements and long-distance migrations." The possible use of magnetoreception for navigation is briefly mentioned.

Avens, L. and K. J. Lohmann. 2003. Use of multiple orientation cues by juvenile loggerhead sea turtles *Caretta caretta*. *Journal of Experimental Biology* 206:4317-4325.

ANNOTATION: The importance of magnetic and visual cues for orientation by juvenile loggerhead sea turtles (*Caretta caretta*) was tested in mesocosm experiments. Orientation capabilities were altered only if both magnetic and visual cues were obscured.

Avens, L. and K. J. Lohmann. 2004. Navigation and seasonal migratory orientation in juvenile sea turtles. *Journal of Experimental Biology* 207:1771-1778.

ANNOTATION: Investigators show that juvenile loggerhead and green turtles are able to orient under test conditions to return to capture locations, or in the direction of migratory routes appropriate to the time of year. These experiments demonstrate homing and map based orientation in sea turtles for the first time. Despite the attractiveness of magnetic cues and cognitive maps, the authors state (on page 1775) "the cue or cues that turtles used to assess their position relative to the capture site cannot be determined from these initial experiments".

Cain, S. D., L. C. Boles, J. H. Wang, and K. J. Lohmann. 2005. Magnetic orientation and navigation in marine turtles, lobsters, and molluscs: Concepts and conundrums. *Integrative and Comparative Biology* 45:539-546.

ANNOTATION: This review discusses the migratory behaviour of sea turtles with respect to regional geomagnetic fields, the magnetic navigation of spiny lobsters, and the neuro mechanisms underlying the orientation of *Tritonia* to DC magnetic fields. Experiments were done displacing hatchling loggerhead sea turtles to determine how they use the earth's magnetic field for migration and/or orientation. Displaced hatchlings swam in directions toward the migration route, and the authors concluded that local magnetic fields are used as navigation markers and can cause changes in swim direction at crucial geographic boundaries. Adult turtles acquired a "magnetic map" allowing them to determine their position. Magnetoreception in marine mammals, the spiny lobster (*Panulirus argus*), and the marine mollusc *Tritonia diomedea* are also discussed.

Courtillot, V., G. Hulot, M. Alexandrescu, J. L. le Mouel, and J. L. Kirschvink. 1997. Sensitivity and evolution of sea-turtle magnetoreception: observations, modeling and constraints from geomagnetic secular variation. *Terra Nova* 9:203-207.

ANNOTATION: This review of Lohmann's studies reinforces the idea that sea turtles have the capacity to detect the inclination and azimuth of the geomagnetic field.

Goff, M., M. Salmon, and K. J. Lohmann. 1998. Hatchling sea turtles use surface waves to establish a magnetic compass direction. *Animal Behaviour* 55:69-77.

ANNOTATION: Inverting the vertical component of the DC magnetic field during the test period reversed the orientation of hatchling turtles swimming into waves. The authors conclude that migratory behavior in turtles lies in multiple cues including the earth's magnetic field.

Hays, G. C., S. Akesson, A. C. Broderick, F. Glen, B. J. Godley, F. Papi, and P. Luschi. 2003. Island-finding ability of marine turtles. *Proceedings of the Royal Society of London Series B-Biological Sciences* 270:S5-S7.

ANNOTATION: This study investigated the importance of wind-borne cues to green turtles for finding Ascension Island. Green turtles (*Chelonia mydas*) swim from foraging grounds along the Brazilian coast to nesting sites over 2200 km away at Ascension Island. Six turtles that had already nested were displaced (3 upwind, 3 downwind) from the island and turtles displaced downwind returned more quickly. The authors discuss the possible use of magnetoreception and suggest that "so far there is no indication of any magnetic navigation ability in turtles from Ascension Island".

Hays, G. C., A. C. Broderick, B. J. Godley, P. Lovell, C. Martin, B. J. McConnell, and S. Richardson. 2002. Biphasal long-distance migration in green turtles. *Animal Behaviour* 64:895-898.

ANNOTATION: This study investigated the migration of green turtles (*Chelonia mydas*) from Ascension Island in the middle of the Atlantic to foraging grounds along the Brazilian coast, over 2000 km away. Turtles were found to swim fairly directly through open ocean to the coast of Brazil, then northward or southward to a final destination. The authors contend that complex navigational systems, such as the use of a magnetic compass, are not necessary for this migration.

Irwin, W. P., A. J. Horner, and K. J. Lohmann. 2004. Magnetic field distortions produced by protective cages around sea turtle nests: unintended consequences for orientation and navigation? *Biological Conservation* 118:117-120.

ANNOTATION: Galvanized steel wire cages are used to protect eggs in nests in Florida. This study determined that the steel cages significantly altered the magnetic field around the eggs (from 5 -26% total intensity bottom to top of the cage respectively, and 4-20% field inclination bottom to top of the cage respectively). Potential problems created may include: 1) disruption of the magnetic compass orientation of hatchlings during their offshore migration, 2) alteration of the turtles' responses to magnetic fields used as navigation markers, and 3) prevention of the turtles reaching their natal beaches as adults. A solution being considered is using cages made of magnetically-inert materials.

Irwin, W. P. and K. J. Lohmann. 2003. Magnet-induced disorientation in hatchling loggerhead sea turtles. *Journal of Experimental Biology* 206:497-501.

ANNOTATION: The authors determined that small magnets attached to loggerhead sea turtle carapaces significantly disrupted their orientation compared to a control group with inert bars attached to their carapaces. Hatchlings were collected from Florida coast and tested in a controlled laboratory setting in an orientation arena. The control group oriented significantly to the east, the magnetic direction preferred based on light cues provided before each trial. The group of turtles with magnets (7400 μ T) known to be stronger than the Earth's magnetic field at the test site (46 μ T) did not significantly orient in a single direction as a group.

Irwin, W. P. and K. J. Lohmann. 2005. Disruption of magnetic orientation in hatchling loggerhead sea turtles by pulsed magnetic fields. *Journal of Comparative Physiology a-Neuroethology Sensory Neural and Behavioral Physiology* 191:475-480.

ANNOTATION: The authors showed that exposure of hatchling loggerhead sea turtles to a strong pulse DC magnetic field of 40 μ T did not disrupt the motivation to swim or the ability to maintain a constant heading towards a light source. In darkness, however, the turtles exposed to the pulse magnetic field did not significantly orient in an offshore direction as did the unexposed controls. The results were interpreted as being consistent with a magnetite-based magnetoreception system.

Light, P., M. Salmon, and K. J. Lohmann. 1993. Geomagnetic orientation of loggerhead sea-turtles - evidence for an inclination compass. *Journal of Experimental Biology* 182:1-9.

ANNOTATION: This study shows that the orientation of swimming loggerhead sea turtle hatchlings can be reversed by inverting the vertical component of the geomagnetic field. But the turtles failed to orient to changes in the horizontal component of the field. This suggests that the magnetic compass of loggerheads is an inclination compass.

Lohmann, K. J. 1991. Magnetic orientation by hatchling loggerhead sea-turtles (*Caretta caretta*). *Journal of Experimental Biology* 155:37-49.

ANNOTATION: This study reports that reversing the horizontal component of the geomagnetic field alters the orientation of hatchling turtles indicating that they can detect the magnetic field of the earth and use it as a cue.

Lohmann, K. J. 2007. Sea turtles: Navigating with magnetism. *Current Biology* 17:R102-R104.

ANNOTATION: The author provides a commentary on Luschi et al., 2007. He emphasizes the unexpected finding that magnets adversely affect navigation regardless of whether the turtles were exposed while homing or during transport to the release site. This suggests that the turtles derive some general information during transport or that strong magnets affect magnetoreceptors for some time after removal of the magnets. Nevertheless, the author concludes that the magnets did not prevent turtles from ultimately reaching their goals and this implies that “when magnetic cues are disrupted, the turtles can fall back on other sources of information ... “

Lohmann, K. J., S. D. Cain, S. A. Dodge, and C. M. F. Lohmann. 2001. Regional magnetic fields as navigational markers for sea turtles. *Science* 294:364-366.

ANNOTATION: The authors exposed turtles to magnetic fields replicating those in three locations along their migratory route in the North Atlantic gyre. The data indicate that the turtles can distinguish between the magnetic fields of these three regions and that this ability may assist turtles to maintain migration patterns.

Lohmann, K. J., J. T. Hester, and C. M. F. Lohmann. 1999. Long-distance navigation in sea turtles. *Ethology Ecology & Evolution* 11:1-23.

ANNOTATION: This review discusses hypotheses regarding navigation by sea turtles using the earth's magnetic field and chemical cues. The authors contend that these two navigation mechanisms are not mutually exclusive and that animals often employ multiple systems of navigation and orientation.

Lohmann, K. J. and C. M. F. Lohmann. 1993. A light-independent magnetic compass in the leatherback sea turtle. *Biological Bulletin* 185:149-151.

ANNOTATION: This study reports that reversal of the magnetic field alters the orientation of the leatherback sea turtle and is effective even in total darkness.

Lohmann, K. J. and C. M. F. Lohmann. 1994a. Acquisition of magnetic directional preference in hatchling loggerhead sea turtles. *Journal of Experimental Biology* 190:1-8.

ANNOTATION: This study reports that light cues effect the preferred direction of magnetic orientation by loggerhead hatchlings.

Lohmann, K. J. and C. M. F. Lohmann. 1994b. Detection of magnetic-inclination angle by sea turtles - a possible mechanism for determining latitude. *Journal of Experimental Biology* 194:23-32.

ANNOTATION: Field line inclination, one of several magnetic parameters, varies predictably along the Earth's surface and is correlated to latitude. This study determined that migrating hatchlings are able to distinguish between inclination angles, and may be using these cues to estimate latitude. Hatchling loggerhead turtles were taken from Boca Raton, Florida and brought to the laboratory for a study using controlled inclination angles meant to mimic those of the Earth's surface. Hatchlings exposed to inclination angles of their natal beaches significantly oriented to the east (as they would normally do during their offshore migration). Hatchlings exposed to the inclination angle of the northern boundary of the North Atlantic gyre swam southwest, and those exposed to the inclination angle of the southern boundary of the North Atlantic gyre swam northeast.

Lohmann, K. J. and C. M. F. Lohmann. 1996a. Detection of magnetic field intensity by sea turtles. *Nature* 380:59-61.

ANNOTATION: This study reports that loggerhead sea turtle hatchlings can distinguish the intensity and also the field line inclination of the earth's geomagnetic field and that this would allow a determination of a magnetic bi-coordinate magnetic field map.

Lohmann, K. J. and C. M. F. Lohmann. 1996b. Orientation and open-sea navigation in sea turtles. *Journal of Experimental Biology* 199:73-81.

ANNOTATION: This review discusses the use of light, magnetic fields and wave motion by sea turtle hatchlings to orient their swimming behavior from the natal beach.

Lohmann, K. J. and C. M. F. Lohmann. 1998a. Migratory guidance mechanisms in marine turtles. *Journal of Avian Biology* 29:585-596.

ANNOTATION: This review summarizes work by the Lohmann laboratory on sea turtles. Despite the advances in their research, the authors conclude that the means by which adult turtles navigate from natal regions to nesting sites, which may include the use of a magnetic compass, is not fully understood.

Lohmann, K. J. and C. M. F. Lohmann. 2006. Sea turtles, lobsters, and oceanic magnetic maps. *Marine and Freshwater Behaviour and Physiology* 39:49-64.

ANNOTATION: This review discusses the author's research on how marine animals, such as sea turtles and spiny lobsters, may use magnetic positional information.

Lohmann, K. J., C. M. F. Lohmann, L. M. Ehrhart, D. A. Bagley, and T. Swing. 2004. Animal behaviour - Geomagnetic map used in sea-turtle navigation. *Nature* 428:909-910.

ANNOTATION: This study reports that green sea turtles orient to their place of capture at least partially by means of magnetic field stimuli. The authors demonstrate that green turtles have a map sense at least partially based on detection of small variations in the earth's magnetic field as a source of positional information.

Lohmann, K. J., C. M. F. Lohmann, and N. F. Putman. 2007. Magnetic maps in animals: nature's GPS. *Journal of Experimental Biology* 210:3697-3705.

ANNOTATION: This brief review summarizes work on the use of magnetic maps by animals, and discusses the authors' work on navigation and orientation by turtles and spiny lobsters.

Lohmann, K. J., P. Luschi, and G. C. Hays. 2008b. Goal navigation and island-finding in sea turtles. *Journal of Experimental Marine Biology and Ecology* 356:83-95.

ANNOTATION: This paper reviews the authors' research on the orientation of juvenile green turtles and the homing ability of adult green turtles. They also discuss the research by Luschi et al., 2007 that reports that the application of magnets to the heads of adult green turtles diminished their homing ability.

Lohmann, K. J., N. F. Putman, and C. M. F. Lohmann. 2008a. Geomagnetic imprinting: A unifying hypothesis of long-distance natal homing in salmon and sea turtles. *Proceedings of the National Academy of Sciences of the United States of America* 105:19096-19101.

ANNOTATION: The hypothesis presented is that some populations of salmon and sea turtles that migrate long distances imprint on the magnetic signature of their birth place, but that non-magnetic local cues are more important in pinpointing nesting and spawning areas.

Lohmann, K. J., B. E. Witherington, C. M. F. Lohmann, and M. Salmon. 1997. Orientation, navigation, and natal beach homing in sea turtles. Pages 107-135 *in* P. L. Lutz and J. A. Musick, editors. *The Biology of Sea Turtles*. CRC Press, Boca Raton, FL.

ANNOTATION: Chapter 5 includes information regarding hatchling emergence and orientation cues (nonmagnetic) in the open ocean compared to natal beach homing and adult navigation cues (geomagnetic).

Luschi, P., S. Akesson, A. C. Broderick, F. Glen, B. J. Godley, F. Papi, and G. C. Hays. 2001. Testing the navigational abilities of ocean migrants: displacement experiments on green sea turtles (*Chelonia mydas*). *Behavioral Ecology and Sociobiology* 50:528-534.

ANNOTATION: This study tracked the migration of displaced female green turtles back to the capture site. The authors' analysis of their behavior suggested that the turtles were not relying on a magnetic map.

Luschi, P., S. Benhamou, C. Girard, S. Ciccione, D. Roos, J. Sudre, and S. Benvenuti. 2007. Marine turtles use geomagnetic cues during open-sea homing. *Current Biology* 17:126-133.

ANNOTATION: The effect of powerful magnets attached to the heads of displaced adult green turtles was investigated on the turtles' return to their home beach. The turtles exposed to the strong DC magnetic fields from the magnets were significantly delayed in their return to the home beach, suggesting that the turtles use geomagnetic cues for navigation.

Papi, F. 2006. Navigation of marine, freshwater and coastal animals: concepts and current problems. *Marine and Freshwater Behaviour and Physiology* 39:3-12.

ANNOTATION: This paper reviews navigation mechanisms and cues used by marine and coastal animals. The use of geomagnetic cues by sea turtles is discussed. The author reports that laboratory evidence for navigation using geomagnetic cues is not confirmed by field experiments in which turtles were magnetically disturbed (magnets attached to their heads) or relocated.

Papi, F. and P. Luschi. 1996. Pinpointing 'Isla Meta': The case of sea turtles and albatrosses. *Journal of Experimental Biology* 199:65-71.

ANNOTATION: This paper compares the abilities of sea turtles and albatrosses to navigate long distances in the open ocean. The shared abilities include: 1) finding a small isolated island or target in the middle of the ocean, 2) staying on course at night even when the moon is not visible, 3) correcting for drift created from currents and wind, and 4) homing after long-distance displacements.

Papi, F., P. Luschi, S. Akesson, S. Capogrossi, and G. C. Hays. 2000. Open-sea migration of magnetically disturbed sea turtles. *Journal of Experimental Biology* 203:3435-3443.

ANNOTATION: The migration of green turtles from Ascension Island to the Brazilian coast was tracked by satellite. The migration patterns of turtles with and without magnets attached to the head were similar. The authors suggest that magnetic cues are not essential to the migration pattern of turtles to the Brazilian coast.

Putman, N. F. and K. J. Lohmann. 2008. Compatibility of magnetic imprinting and secular variation. *Current Biology* 18:R596-R597.

ANNOTATION: The authors compare the migration patterns of Kemps ridley turtle to variations in magnetic field over the past 400 years predicted by models. The purpose of the study was to determine whether "secular variation", or small gradual changes in the Earth's magnetic field over time, would confound the use of magnetic signatures for natal homing. The authors conclude that the magnetic imprinting hypothesis provides a plausible explanation for how marine species such as sea turtles, salmon, and elephant seals can return to their natal regions along continental coastlines after long absences (over a decade). Studies are needed to determine whether magnetic imprinting actually occurs in these species.

Walker, M. M., C. E. Diebel, and J. L. Kirschvink. 2003. Chapter 3: Detection and use of the Earth's magnetic field by aquatic vertebrates. Pages 53-74 *in* S. P. Collin and N. J. Marshall, editors. *Sensory Processing in Aquatic Environments*. Springer-Verlag, New York.

ANNOTATION: Magnetic senses exhibit similar properties found in other specialized sensory systems. Magnetic senses of vertebrates and birds have many similarities. The magnetic sense of aquatic vertebrates is likely to be highly sensitive to small changes in magnetic fields.

Appendix A-11 Invertebrates – Electric Sense

Bullock, T. H. 1999. The future of research on electroreception and electrocommunication. *Journal of Experimental Biology* 202:1455-1458.

ANNOTATION: This editorial considers the future of research on electroreception and electrocommunication. The author predicts that additional taxa with capabilities to sense electric fields will be discovered and speculates about which groups are most likely to include electroreceptive species. The author discusses that little research has been done to investigate electroreception in invertebrates and mentions molluscs, arthropods, and annelids as potential candidate groups for future review. Much of the paper focuses on fish species. The author questions the role of weak electric organ discharges by electric fish and identifies this as an area in need of further research. One marine species mentioned in this discussion is the stargazer, a marine teleost in the family Uranoscopidae, reported as an electric species by Pickens and McFarland (1964).

Patullo, B. W. and D. L. Macmillan. 2007. Crayfish respond to electrical fields. *Current Biology* 17:R83-R84.

ANNOTATION: Crayfish (*Cherax destructor*) exhibited changes in behavior in response to DC electric fields producing current densities of 0.4 $\mu\text{A}/\text{cm}^2$. This study looked at responses immediately upon stimulus onset and so the effective electric field stimulus may be greater and include higher frequency components than suggested by the applied stimulus considered as a static exposure.

Steullet, P., D. H. Edwards, and C. D. Derby. 2007. An electric sense in crayfish? *Biological Bulletin* 213:16-20.

ANNOTATION: Stimulation of crayfish with electric fields at DC, 4 Hz, 10 Hz, 100 Hz, and 1000 Hz stimulated behavioral responses only to high-intensity fields (20 mV/cm or greater). The strongest responses to the electric field were reported at 4 Hz. Electrophysiological recordings of sensory afferents showed responses to food odors, mechanical stimulation, etc. as well as to electric fields, which suggested to the investigators that electric fields stimulate chemo- and mechano-sensory neurons, not specialized electric field receptors, and therefore electric fields may not be sensed for the detection of prey.

Appendix A-12 Invertebrates – Magnetic Sense

Alerstam, T. 2003. Animal behaviour - The lobster navigators. *Nature* 421:27-28.

ANNOTATION: Commentary on Boles and Lohmann, 2003, and discussion of navigation by spiny lobster (*Panulirus argus*) using a magnetic map sense.

Bochert, R. and M. L. Zettler. 2004. Long-term exposure of several marine benthic animals to static magnetic fields. *Bioelectromagnetics* 25:498-502.

ANNOTATION: The prawn, crab, isopod, flounder, and mussels were allocated to groups exposed to 3.7 mT DC magnetic fields or control conditions for up to seven weeks. No differences in longevity were observed. Further observations of mussels for fitness and gonadal development did not reveal differences between exposed and control groups. The DC magnetic field intensity was selected to simulate maximum exposures to magnetic fields from DC undersea cables in the Baltic Sea.

Boles, L. C. and K. J. Lohmann. 2003. True navigation and magnetic maps in spiny lobsters. *Nature* 421:60-63.

ANNOTATION: This study involved tagging and displacement of spiny lobster (*Panulirus argus*) to an unfamiliar location to investigate orientation relative to true navigation capabilities. The orientation of the lobsters transported to different locations was consistent with the use of the geomagnetic field for navigation. Additional experiments using artificially replicated geomagnetic fields confirmed this finding.

Cain, S. D., L. C. Boles, J. H. Wang, and K. J. Lohmann. 2005. Magnetic orientation and navigation in marine turtles, lobsters, and molluscs: Concepts and conundrums. *Integrative and Comparative Biology* 45:539-546.

ANNOTATION: This review discusses the migratory behaviour of sea turtles with respect to regional geomagnetic fields, the magnetic navigation of spiny lobsters, and the neuro mechanisms underlying the orientation of *Tritonia* to DC magnetic fields. Experiments were done displacing hatchling loggerhead sea turtles to determine how they use the earth's magnetic field for migration and/or orientation. Displaced hatchlings swam in directions toward the migration route, and the authors concluded that local magnetic fields are used as navigation markers and can cause changes in swim direction at crucial geographic boundaries. Adult turtles acquired a "magnetic map" allowing them to determine their position. Magnetoreception in marine mammals, the spiny lobster (*Panulirus argus*), and the marine mollusc *Tritonia diomedea* are also discussed.

Cain, S. D., J. H. Wang, and K. J. Lohmann. 2006. Immunochemical and electrophysiological analyses of magnetically responsive neurons in the mollusc *Tritonia diomedea*. *Journal of Comparative Physiology a-Neuroethology Sensory Neural and Behavioral Physiology* 192:235-245.

ANNOTATION: This study reports the response of pedal neurons in the gastropod *Tritonia diomedea* to variations in the ambient geomagnetic field.

Cameron, I. L., W. E. Hardman, W. D. Winters, S. Zimmerman, and A. M. Zimmerman. 1993. Environmental magnetic-fields - influences on early embryogenesis. *Journal of Cellular Biochemistry* 51:417-425.

ANNOTATION: The authors report that 60 Hz magnetic fields affect cell proliferation in a field dependent way at the morula stage of the purple sea urchin, but the cleavage stage was not affected. They further report that 60 Hz magnetic fields reduce the expression of histone gene expression at the morula stage.

Delgado, J. M. R. 1985. Biological Effects of Extremely Low Frequency Electromagnetic Fields. *Journal of Bioelectricity* 4:75.

ANNOTATION: This paper presents limited data on the response of crayfish to magnetic field stimulation. Magnetic fields with frequencies above 12 Hz were not effective in changing the discharge of the crayfish stretch receptor.

Kirschvink, J. L. and H. A. Lowenstam. 1979. Mineralization and magnetization of chiton teeth - paleomagnetic, sedimentologic, and biologic implications of organic magnetite. *Earth and Planetary Science Letters* 44:193-204.

ANNOTATION: This study investigated tooth formation and the production of biogenic magnetite in chitons. The structure of chiton teeth is described in detail based on scanning electron micrographs. Magnetic properties of the magnetite in chiton teeth are discussed. The function of magnetite in chitons is to harden teeth. Among the author's conclusions was the following: "Grain-to-grain interactions drastically reduce the stability of chiton teeth towards alternating field demagnetization, yielding natural magnetization values near $0.1 \text{ A m}^2/\text{kg}$."

Levin, M. and S. G. Ernst. 1997. Applied DC magnetic fields cause alterations in the time of cell divisions and developmental abnormalities in early sea urchin embryos. 18:8.

ANNOTATION: A 30 mT DC magnetic field was reported to delay hatching of embryos and early cell division. This response was not caused when the sperm alone were exposed. Exposure for 48 to 94 hrs caused a teratogenic response (malformation) in *L. pictus* only. There was a lack of a dose response with time.

Lohmann, K. J. 1984. Magnetic remanence in the Western Atlantic spiny lobster, *Panulirus argus*. *Journal of Experimental Biology* 113:29-41.

ANNOTATION: This study reports higher concentrations of magnetic material in the cephalothorax; however, the author reports that there is currently no evidence that this magnetic material functions as a transducer or a magnetic sense.

Lohmann, K. J. 1985. Geomagnetic-field detection by the Western Atlantic spiny lobster, *Panulirus argus*. *Marine Behaviour and Physiology* 12:1-17.

ANNOTATION: This study used conditioning experiments to test if western Atlantic spiny lobsters (*Panulirus argus*) could orient using geomagnetic cues. The author reports that conditioned lobsters entered north-south aligned tunnels in the experimental chambers significantly more often than other tunnels, but the lobsters did not discriminate north from south in these experiments. When a pair of conditioned lobsters was subjected to an altered magnetic field, the lobsters shifted to the new north-south magnetic axis, confirming the use of magnetoreception and providing evidence that *Panulirus argus* can use the earth's magnetic field as a directional cue.

Lohmann, K. J. and C. M. F. Lohmann. 2006. Sea turtles, lobsters, and oceanic magnetic maps. *Marine and Freshwater Behaviour and Physiology* 39:49-64.

ANNOTATION: This review discusses the author's research on how marine animals, such as sea turtles and spiny lobsters, may use magnetic positional information.

Lohmann, K. J., C. M. F. Lohmann, and N. F. Putman. 2007. Magnetic maps in animals: nature's GPS. *Journal of Experimental Biology* 210:3697-3705.

ANNOTATION: This brief review summarizes work on the use of magnetic maps by animals, and discusses the authors' work on navigation and orientation by turtles and spiny lobsters.

Lohmann, K. J., N. D. Pentcheff, G. A. Nevitt, G. D. Stetten, R. K. Zimmerfaust, H. E. Jarrard, and L. C. Boles. 1995. Magnetic orientation of spiny lobsters in the ocean - experiments with undersea coil systems. *Journal of Experimental Biology* 198:2041-2048.

ANNOTATION: Lobsters exposed to a reversal of the horizontal geomagnetic field altered their orientation. The authors' data are consistent with the hypothesis that lobsters have a polarity compass not an inclination compass. They also conclude that the data provide no support for a common direction (homing) of individual lobsters.

Lohmann, K. J. and A. O. D. Willows. 1987. Lunar-modulated geomagnetic orientation by a marine mollusk. *Science* 235:331-334.

ANNOTATION: This paper reports that behavioral experiments with *Tritonia diomedea* demonstrate that this marine opisthobranch mollusk can derive directional information from the earth's magnetic field, and can use this information for orientation. The authors report that variation in this behavioral response was correlated with the lunar phase.

Lohmann, K. J., A. O. D. Willows, and R. B. Pinter. 1991. An identifiable molluscan neuron responds to changes in Earth-strength magnetic fields. *Journal of Experimental Biology* 161:1-24.

ANNOTATION: The authors report that pedal neurons of the marine mollusc, *Tritonia diomedea*, respond to a change in the geomagnetic field with a delayed increase in spike activity not related to induced electric potentials.

LOWENSTAM, H. A. 1962. Magnetite in Denticle Capping in Recent Chitons (Polyplacophora). *Geological Society of America Bulletin* 73:435-438.

ANNOTATION: This paper describes the discovery of magnetite in denticle cappings of chitons (Polyplacophora). The author indicates that this is the first report of biogenic magnetite in a marine organism. The author speculates that the magnetite may function to guide the "homing instinct" of chitons.

Malagoli, D., F. Gobba, and E. Ottaviani. 2003. Effects of 50-Hz magnetic fields on the signaling pathways of fMLP-induced shape changes in invertebrate immunocytes: the activation of an alternative "stress pathway". *Biochimica et biophysica acta* 1620:5.

ANNOTATION: Fifteen- to thirty-minute exposure of immunocytes at 300 – 600 μ T produced changes in the shape of immunocytes.

Malagoli, D., M. Lusvardi, F. Gobba, and E. Ottaviani. 2004. 50 Hz magnetic fields activate mussel immunocyte p38 MAP kinase and induce HSP70 and 90. *Comparative biochemistry and physiology. Toxicology & pharmacology : CBP* 137:4.

ANNOTATION: One to three exposures of mussels for 30 minutes to AC magnetic fields above a 400 μ T threshold increased concentration of heat shock proteins hsp70 and hsp90. The concentration of heat shock proteins increased with time of exposure.

Ottaviani, E., D. Malagoli, A. Ferrari, D. Tagliazucchi, A. Conte, and F. Gobba. 2002. 50 Hz magnetic fields of varying flux intensity affect cell shape changes in invertebrate immunocytes: the role of potassium ion channels. *Bioelectromagnetics* 23:5.

ANNOTATION: Exposure of mussels to magnetic fields for 15 and 30 minutes produced changes in the shape of immunocytes. The threshold for stimulation was 300 μ T and toxic changes were seen at 700 μ T.

Popescu, I. R. and A. O. D. Willows. 1999. Sources of magnetic sensory input to identified neurons active during crawling in the marine mollusc *Tritonia diomedea*. *Journal of Experimental Biology* 202:3029-3036.

ANNOTATION: The investigators recorded the activity of nerves from pedal ganglion neurons in response to the rotation in the horizontal component of the geomagnetic field. The authors suggest that the pedal ganglion neurons play a motor role in the orientation of *Tritonia* to magnetic fields.

Ueno, S., P. Lovsund, and P. A. Oberg. 1986. Effect of time-varying magnetic fields on the action potential in lobster giant axon. *Medical and Biological Engineering and Computing* 24.

ANNOTATION: The authors tested the isolated gigantic axon for responses to alternating magnetic fields. No effect of one cycle of 500 Hz 0.2 T magnetic field or a 50 Hz 0.8 T magnetic field was reported on this nerve.

Ugolini, A. 2006. Equatorial sandhoppers use body scans to detect the earth's magnetic field. *Journal of Comparative Physiology a-Neuroethology Sensory Neural and Behavioral Physiology* 192:45-49.

ANNOTATION: The experiments indicate that cancellation of the DC geomagnetic field increased the body movements described as "scanning" for the magnetic field.

Ugolini, A. and A. Pezzani. 1995. Magnetic compass and learning of the y-axis (sea-land) direction in the marine isopod *Idotea baltica*, Basteri. *Animal Behaviour* 50:295-300.

ANNOTATION: This study demonstrated that the a marine isopod, *Idotea baltica* basteri, possesses a magnetic compass. Results indicate that this species uses the earth's magnetic field to orient relative to the shoreline. Experiments also indicated that *I. baltica* can change its magnetic compass set point based on local cues. The authors discuss that *I. baltica* also uses the sun for orientation.

Uzdensky, A. B., O. Y. Kutko, and A. B. Kogan. 1997. Effect of Weak Extremely Low Frequency Magnetic Field on Isolated Crayfish Stretch Receptor Neuron: Nonlinear Dependence on Field Amplitude and Frequency. *Electromagnetic Biology and Medicine* 16:12.

ANNOTATION: Exposures to 0.001-100 Hz AC magnetic fields and intensities of 1-400 μ T affected slowly developing nerve impulse activity in single mechano-receptor crayfish neurons.

Wang, J. H., S. D. Cain, and K. J. Lohmann. 2003. Identification of magnetically responsive neurons in the marine mollusc *Tritonia diomedea*. *Journal of Experimental Biology* 206:381-388.

ANNOTATION: The authors report that two-pedal efferent neurons in the marine mollusc *Tritonia diomedea* are sensitive to variations in the geomagnetic field.

Wang, J. H., S. D. Cain, and K. J. Lohmann. 2004. Identifiable neurons inhibited by Earth-strength magnetic stimuli in the mollusc *Tritonia diomedea*. *Journal of Experimental Biology* 207:1043-1049.

ANNOTATION: This study identifies the electrophysiological response to neurons in which the orientation of the geomagnetic field is changed.

Williamson, R. 1995. A sensory basis for orientation in cephalopods. *Journal of the Marine Biological Association of the United Kingdom* 75:83-92.

ANNOTATION: This review of sensory systems used by cephalopods for orientation indicates that there is no existing evidence for electric or magnetic sensitivity in cephalopods.

Willows, A. O. D. 1999. Shoreward orientation involving geomagnetic cues in the nudibranch mollusc *Tritonia diomedea*. *Marine and Freshwater Behaviour and Physiology* 32:181-192.

ANNOTATION: Following work that demonstrated magnetosensitivity in the marine opisthobranch mollusk *Tritonia diomedea*, this study investigated if and why this organism orients using the earth's magnetic field in its natural environment. Animals were displaced from their original locations by SCUBA divers and movement was monitored over two or more tidal cycles. The authors report that most animals appear to use geomagnetic cues to move in a shoreward direction (relative to geomagnetic field cues at the collection sites, though not necessarily shoreward at the release site). The authors suggest that since food sources and mates are located in nearshore habitats, shoreward movement may represent an adaptation in these organisms, which are frequently dislodged by tidal currents and during predator escape responses.

Willows, A. O. D. 2001. Costs and benefits of opisthobranch swimming and neurobehavioral mechanisms. *American Zoologist* 41:943-951.

ANNOTATION: This review discusses the way in which magnetic fields would influence the movement of *Tritonia diomedea*.

Ye, S. R., J. W. Yang, and C. M. Chen. 2004. Effect of static magnetic fields on the amplitude of action potential in the lateral giant neuron of crayfish. *International journal of radiation biology* 80:699-708.

ANNOTATION: Five minutes of exposure of 8.08 mT DC magnetic fields was the threshold for the change in the action potential magnitude. Exposure up to 3 hrs diminished responses at higher intensities.

Appendix B

Undersea Cable Projects and AC and DC Magnetic Field Modeling

Appendix B provides additional information on existing and proposed undersea cables (Appendix Tables B-1 and B-13) and expanded results from modeling of magnetic and induced electric fields (Appendix Tables B-2 through B-12 and Appendix Figures B-1 and B-2). All tables represent the average of all cables (either AC or DC) that were modeled.

Note: highlighting on Appendix Tables B-2 and B-5 through B-12 was used to show order-of-magnitude breaks for ease of reading and has no meaning in terms of potential impact.

Appendix Table B-1. Summary of information on existing and proposed undersea power cables.

Existing and proposed undersea power cables.

Year	Name	Country	Landfalls	Waterway	Length (km)	Frequency (Hz)	Voltage (KV)	Maximum Capacity (MW)	Calcs ^a	Marine Assess ^b
Existing Power Cables										
1969	1385 Line Cable System (NU/LIPA)	US	Norwalk, CT Northport, NY	Norwalk Harbor/Long Island Sound	11.7	60	138	300	-	-
1996	Nantucket Cable #1	US	Harwich, MA Nantucket Is, MA	Nantucket Sound (Horseshoe Shoal)	26	60	46	35	Y	N
1998	Haines Scagway Submarine Cable Intertie Project	US	Haines, AK Skagway, AK	Taiya Inlet	24.2	60	35	15	-	-
2000	SwePol Link	SW/POL	Karlshamm, Sweden Slupsk, Poland	Baltic Sea	245 km	0	±450	600 Max	Y	-
2001	?	US	Galeveston, TX Galeveston Island, TX	?	?	60	138	200	?	?
2002	Replacement of 138kV Submarine Electric Transmission Cable System	US	Norwalk, CT Northport, NY	Norwalk Harbor/Long Island Sound	17.7	60	138	300	Y	Y
2002	Cross Sound Cable	US	New Haven, CT Brookhaven, NY	Long Island Sound	38.6	0	± 150	330	Y	Y
2002	San Juan Cable Project	US	Fidalgo Island Lopez Island	Puget Sound	13.5	60	69		-	-
2003	Nysted Offshore Wind Farm	DE	Baltic Sea Nysted, Denmark	Baltic Sea	48 km	50	33 to 132	165.6	-	Y

Appendix Table B-1. Existing and proposed undersea power cables (continued)

Year	Name	Country	Landfalls	Waterway	Length (km)	Frequency (Hz)	Voltage (KV)	Maximum Capacity (MW)	Calcs ^a	Marine Assess ^b
Existing Power Cables										
2005	Kentish Flats Offshore Wind Farm	UK	Thames Estuary Whitstable, UK	North Sea	10 km	50	33 to 132	30 wind turbines of 3 MW capacity each for a total of 90 MW	-	-
2006	Nantucket Cable #2	US	Barnstable, MA Nantucket Is, MA	Nantucket Sound (Horseshoe Shoal)	33	60	46	35	Y	N
2006	Basslink Interconnector	AU	Tasmania Victoria	Bass Strait	290 km	0	±400	500	Y	Y
2006	Neptune Regional Transmission System	US	Sayreville, NJ Hicksville, NY	Atlantic Ocean (New York Bight)	82 km	0	±500	660	Y	-
2007	Kaipara Harbour Marine Turbine Power Generation Project	NZ	Kaipara Harbor	Kaipara Harbor	7km	0	± 75	200	-	Y
			Puoto Point, NZ Tikinui Raupo	Wairoa River		0	± 75	200	-	Y
2008-2009	Vancouver Island Transmission Reinforcement	CA	Saltspring Island	Trincomali Channel	3.9 km	60	230	600	-	-
			Galiano/Parker Island Tsawwassen	Strait of Georgia	23.5 km	60	230	600	-	-
2009	Middletown-Norwalk	US	Various River Crossings			60	345			
2009	Horns Rev 2 Offshore Windfarm	DE	North Sea Blåvands Huk	North Sea	14-20km	60	33 to 132	160	-	Y

Appendix Table B-1. Existing and proposed undersea power cables (continued)

Year	Name	Country	Landfalls	Waterway	Length (km)	Frequency (Hz)	Voltage (KV)	Maximum Capacity (MW)	Calcs ^a	Marine Assess ^b
Existing Power Cables										
2010	Trans Bay Cable	US	Oakland, CA San Francisco, CA	San Francisco Bay and Carquinez Straits	53 mi	0	± 200	400	-	-
Proposed Power Cables										
	Cape Wind Energy Project	US	Nantucket Sound Yarmouth MA	Nantucket Sound (Horseshoe Shoal)	20.1 km	60	33	3.6	Y	Y
						60	115x 2	454 max; 182.6 avg	Y	Y
	EirGrid Irish Interconnector Project	IR/UK	Barkby Beach, North Wales in Britain Rush North Beach, Co. Dublin in Ireland	Irish Sea	185 km	0	± 400	500	Y	Y
	Long Island Offshore Wind Park ¹	US	Wind Park (Atlantic Ocean) West Amityville, NY	Atlantic Ocean	<8.9	69	138 kV; 34.5kV	140	Y	-
	Naikun Wind Energy Project	CA	Offshore converter Station Mainland	Hecate Straight	95 km	0	± 200	400	Y	Y
			Offshore Converter Station Haida Gwaii		50 km	60	33	20	Y	Y
	Port Angeles-Juan de Fuca Transmission Project	CA/US	View Royal, British Columbia Port Angeles, WA	Strait of Juan de Fuca	16.9 km in US, 20 km in Canadian waters	0	± 150	550	Y	Y

^aCalcs = were calculations of magnetic fields available from cable owners or permitting agencies? (Y=yes, N=no)

^bMarine Assess = was an assessment of potential significance of magnetic fields on surrounding marine habitat available? (Y=yes, N=no)

Appendix Table B-2.

Table of average AC magnetic fields computed for various projects at distances along and above seabed.

Magnetic Field (microTesla)		Distance above seabed (m)										
		0	5	10	15	20	25	30	35	40	45	50
Distance along seabed (m)	0	7.85E+0	3.47E-1	1.27E-1	6.52E-2	3.94E-2	2.62E-2	1.87E-2	1.40E-2	1.09E-2	8.69E-3	7.10E-3
	±2	2.42E+0	3.30E-1	1.25E-1	6.44E-2	3.91E-2	2.61E-2	1.87E-2	1.40E-2	1.09E-2	8.67E-3	7.09E-3
	±4	1.47E+0	2.85E-1	1.17E-1	6.21E-2	3.82E-2	2.57E-2	1.84E-2	1.39E-2	1.08E-2	8.63E-3	7.06E-3
	±6	7.70E-1	2.31E-1	1.06E-1	5.86E-2	3.68E-2	2.51E-2	1.81E-2	1.37E-2	1.07E-2	8.55E-3	7.00E-3
	±8	3.80E-1	1.80E-1	9.28E-2	5.43E-2	3.50E-2	2.42E-2	1.76E-2	1.34E-2	1.05E-2	8.45E-3	6.93E-3
	±10	2.23E-1	1.38E-1	8.00E-2	4.95E-2	3.29E-2	2.32E-2	1.71E-2	1.31E-2	1.03E-2	8.31E-3	6.84E-3
	±12	1.47E-1	1.06E-1	6.82E-2	4.47E-2	3.07E-2	2.20E-2	1.65E-2	1.27E-2	1.01E-2	8.16E-3	6.74E-3
	±14	1.05E-1	8.29E-2	5.79E-2	4.00E-2	2.84E-2	2.08E-2	1.58E-2	1.23E-2	9.80E-3	7.98E-3	6.62E-3
	±16	7.90E-2	6.61E-2	4.93E-2	3.57E-2	2.61E-2	1.96E-2	1.50E-2	1.18E-2	9.51E-3	7.79E-3	6.48E-3
	±18	6.16E-2	5.36E-2	4.21E-2	3.18E-2	2.39E-2	1.83E-2	1.43E-2	1.14E-2	9.20E-3	7.58E-3	6.34E-3
	±20	4.95E-2	4.43E-2	3.61E-2	2.83E-2	2.19E-2	1.71E-2	1.35E-2	1.09E-2	8.88E-3	7.36E-3	6.18E-3
	±22	4.06E-2	3.71E-2	3.12E-2	2.52E-2	2.00E-2	1.59E-2	1.28E-2	1.04E-2	8.55E-3	7.13E-3	6.02E-3
	±24	3.39E-2	3.15E-2	2.72E-2	2.25E-2	1.83E-2	1.48E-2	1.20E-2	9.89E-3	8.21E-3	6.90E-3	5.85E-3
	±26	2.88E-2	2.70E-2	2.38E-2	2.01E-2	1.67E-2	1.37E-2	1.13E-2	9.41E-3	7.88E-3	6.66E-3	5.68E-3
	±28	2.48E-2	2.34E-2	2.10E-2	1.81E-2	1.53E-2	1.28E-2	1.07E-2	8.94E-3	7.54E-3	6.42E-3	5.50E-3
	±30	2.15E-2	2.05E-2	1.86E-2	1.63E-2	1.40E-2	1.18E-2	1.00E-2	8.48E-3	7.22E-3	6.18E-3	5.33E-3
	±32	1.89E-2	1.81E-2	1.66E-2	1.47E-2	1.28E-2	1.10E-2	9.40E-3	8.04E-3	6.89E-3	5.94E-3	5.15E-3
	±34	1.67E-2	1.61E-2	1.49E-2	1.34E-2	1.18E-2	1.02E-2	8.83E-3	7.62E-3	6.58E-3	5.71E-3	4.97E-3
	±36	1.49E-2	1.44E-2	1.34E-2	1.22E-2	1.08E-2	9.52E-3	8.30E-3	7.22E-3	6.28E-3	5.48E-3	4.80E-3
	±38	1.33E-2	1.29E-2	1.22E-2	1.11E-2	1.00E-2	8.87E-3	7.80E-3	6.84E-3	5.99E-3	5.26E-3	4.63E-3
	±40	1.20E-2	1.17E-2	1.11E-2	1.02E-2	9.25E-3	8.27E-3	7.33E-3	6.47E-3	5.71E-3	5.04E-3	4.46E-3
	±42	1.09E-2	1.06E-2	1.01E-2	9.39E-3	8.57E-3	7.72E-3	6.90E-3	6.13E-3	5.44E-3	4.83E-3	4.29E-3
	±44	9.91E-3	9.70E-3	9.26E-3	8.66E-3	7.95E-3	7.22E-3	6.50E-3	5.81E-3	5.19E-3	4.63E-3	4.13E-3
	±46	9.06E-3	8.88E-3	8.51E-3	8.00E-3	7.40E-3	6.76E-3	6.12E-3	5.51E-3	4.95E-3	4.44E-3	3.98E-3
	±48	8.32E-3	8.17E-3	7.85E-3	7.42E-3	6.90E-3	6.34E-3	5.77E-3	5.23E-3	4.72E-3	4.25E-3	3.83E-3
	±50	7.66E-3	7.53E-3	7.27E-3	6.89E-3	6.44E-3	5.95E-3	5.45E-3	4.96E-3	4.50E-3	4.07E-3	3.68E-3
	±52	7.08E-3	6.97E-3	6.74E-3	6.42E-3	6.03E-3	5.59E-3	5.15E-3	4.71E-3	4.29E-3	3.90E-3	3.55E-3
	±54	6.56E-3	6.47E-3	6.27E-3	5.99E-3	5.65E-3	5.27E-3	4.87E-3	4.48E-3	4.10E-3	3.74E-3	3.41E-3
	±56	6.10E-3	6.02E-3	5.85E-3	5.60E-3	5.30E-3	4.96E-3	4.61E-3	4.26E-3	3.91E-3	3.59E-3	3.28E-3
	±58	5.68E-3	5.61E-3	5.47E-3	5.25E-3	4.99E-3	4.69E-3	4.37E-3	4.05E-3	3.74E-3	3.44E-3	3.16E-3
±60	5.31E-3	5.25E-3	5.12E-3	4.93E-3	4.70E-3	4.43E-3	4.15E-3	3.86E-3	3.57E-3	3.30E-3	3.04E-3	

Appendix Table B-2. Table of average AC magnetic fields computed for various projects at distances along and above seabed.
(continued)

Magnetic Field (microTesla)	Distance above seabed (m)										
	0	5	10	15	20	25	30	35	40	45	50
±62	4.97E-3	4.92E-3	4.80E-3	4.64E-3	4.43E-3	4.19E-3	3.94E-3	3.68E-3	3.42E-3	3.17E-3	2.93E-3
±64	4.66E-3	4.62E-3	4.52E-3	4.37E-3	4.18E-3	3.97E-3	3.74E-3	3.51E-3	3.27E-3	3.04E-3	2.82E-3
±66	4.39E-3	4.34E-3	4.25E-3	4.12E-3	3.96E-3	3.77E-3	3.56E-3	3.35E-3	3.13E-3	2.92E-3	2.71E-3
±68	4.13E-3	4.09E-3	4.01E-3	3.90E-3	3.75E-3	3.58E-3	3.39E-3	3.20E-3	3.00E-3	2.80E-3	2.61E-3
±70	3.90E-3	3.86E-3	3.79E-3	3.69E-3	3.56E-3	3.40E-3	3.23E-3	3.05E-3	2.87E-3	2.69E-3	2.52E-3
±72	3.68E-3	3.65E-3	3.59E-3	3.50E-3	3.38E-3	3.24E-3	3.08E-3	2.92E-3	2.76E-3	2.59E-3	2.43E-3
±74	3.49E-3	3.46E-3	3.40E-3	3.32E-3	3.21E-3	3.08E-3	2.94E-3	2.80E-3	2.64E-3	2.49E-3	2.34E-3
±76	3.30E-3	3.28E-3	3.23E-3	3.15E-3	3.06E-3	2.94E-3	2.81E-3	2.68E-3	2.54E-3	2.40E-3	2.26E-3
±78	3.14E-3	3.12E-3	3.07E-3	3.00E-3	2.91E-3	2.81E-3	2.69E-3	2.57E-3	2.44E-3	2.31E-3	2.18E-3
±80	2.98E-3	2.96E-3	2.92E-3	2.86E-3	2.78E-3	2.68E-3	2.58E-3	2.46E-3	2.34E-3	2.22E-3	2.10E-3
±82	2.84E-3	2.82E-3	2.78E-3	2.73E-3	2.65E-3	2.57E-3	2.47E-3	2.36E-3	2.25E-3	2.14E-3	2.03E-3
±84	2.70E-3	2.69E-3	2.65E-3	2.60E-3	2.54E-3	2.46E-3	2.37E-3	2.27E-3	2.17E-3	2.06E-3	1.96E-3
±86	2.58E-3	2.56E-3	2.53E-3	2.49E-3	2.43E-3	2.35E-3	2.27E-3	2.18E-3	2.09E-3	1.99E-3	1.89E-3
±88	2.46E-3	2.45E-3	2.42E-3	2.38E-3	2.32E-3	2.26E-3	2.18E-3	2.10E-3	2.01E-3	1.92E-3	1.83E-3
±90	2.35E-3	2.34E-3	2.32E-3	2.28E-3	2.23E-3	2.16E-3	2.09E-3	2.02E-3	1.94E-3	1.85E-3	1.77E-3
±92	2.25E-3	2.24E-3	2.22E-3	2.18E-3	2.13E-3	2.08E-3	2.01E-3	1.94E-3	1.87E-3	1.79E-3	1.71E-3
±94	2.16E-3	2.15E-3	2.13E-3	2.09E-3	2.05E-3	2.00E-3	1.94E-3	1.87E-3	1.80E-3	1.73E-3	1.66E-3
±96	2.07E-3	2.06E-3	2.04E-3	2.01E-3	1.97E-3	1.92E-3	1.87E-3	1.81E-3	1.74E-3	1.67E-3	1.60E-3
±98	1.99E-3	1.98E-3	1.96E-3	1.93E-3	1.89E-3	1.85E-3	1.80E-3	1.74E-3	1.68E-3	1.62E-3	1.55E-3
±100	1.91E-3	1.90E-3	1.88E-3	1.86E-3	1.82E-3	1.78E-3	1.73E-3	1.68E-3	1.62E-3	1.57E-3	1.50E-3

Appendix Table B-3.

Maximum induced Root Mean Square (RMS) electric field averaged over various projects with AC undersea cables for species located directly above and parallel to the cable^a assuming 5 knot current or swimming speed.

Species	Major, Minor Axis of Ellipse Enclosing Species	Height Above Seabed	Induced Electric Field ($\mu\text{V}/\text{m}$)
Smalltooth sawfish	540 cm, 90 cm	0.5 m	612.4
Juvenile sandbar shark	50 cm, 20 cm	0.5 m	120.6
Generic small shark	150 cm, 60 cm	0 m	765.5
		0.5 m	361.7
		1.0 m	209.1
		2.0 m	103.1
		5.0 m	33.9
		10.0 m	12.4

^aOther orientations will result in lower values of induced electric fields.

Appendix Table B-4.

Table of average DC magnetic fields computed for various projects at distances along and above seabed.

Magnetic Field (microTesla)	Distance above seabed (m)											
	0	5	10	15	20	25	30	35	40	45	50	
0	78.27	2.73	0.83	0.40	0.23	0.15	0.11	0.08	0.06	0.05	0.04	
±2	19.55	2.47	0.81	0.39	0.23	0.15	0.11	0.08	0.06	0.05	0.04	
±4	5.98	1.92	0.74	0.37	0.22	0.15	0.11	0.08	0.06	0.05	0.04	
±6	2.78	1.40	0.65	0.35	0.21	0.14	0.10	0.08	0.06	0.05	0.04	
±8	1.59	1.02	0.55	0.32	0.20	0.14	0.10	0.08	0.06	0.05	0.04	
±10	1.02	0.75	0.46	0.29	0.19	0.13	0.10	0.07	0.06	0.05	0.04	
±12	0.71	0.57	0.39	0.26	0.18	0.13	0.09	0.07	0.06	0.05	0.04	
±14	0.53	0.44	0.32	0.23	0.16	0.12	0.09	0.07	0.05	0.04	0.04	
±16	0.40	0.35	0.27	0.20	0.15	0.11	0.08	0.07	0.05	0.04	0.04	
±18	0.32	0.29	0.23	0.18	0.13	0.10	0.08	0.06	0.05	0.04	0.04	
±20	0.26	0.24	0.20	0.16	0.12	0.10	0.08	0.06	0.05	0.04	0.03	
±22	0.21	0.20	0.17	0.14	0.11	0.09	0.07	0.06	0.05	0.04	0.03	
±24	0.18	0.17	0.15	0.12	0.10	0.08	0.07	0.06	0.05	0.04	0.03	
±26	0.15	0.15	0.13	0.11	0.09	0.08	0.06	0.05	0.04	0.04	0.03	
±28	0.13	0.13	0.11	0.10	0.08	0.07	0.06	0.05	0.04	0.04	0.03	
±30	0.12	0.11	0.10	0.09	0.08	0.07	0.06	0.05	0.04	0.03	0.03	
±32	0.10	0.10	0.09	0.08	0.07	0.06	0.05	0.04	0.04	0.03	0.03	
±34	0.09	0.09	0.08	0.07	0.06	0.06	0.05	0.04	0.04	0.03	0.03	
±36	0.08	0.08	0.07	0.07	0.06	0.05	0.05	0.04	0.03	0.03	0.03	
±38	0.07	0.07	0.07	0.06	0.05	0.05	0.04	0.04	0.03	0.03	0.03	
±40	0.06	0.06	0.06	0.06	0.05	0.05	0.04	0.04	0.03	0.03	0.02	
±42	0.06	0.06	0.05	0.05	0.05	0.04	0.04	0.03	0.03	0.03	0.02	
±44	0.05	0.05	0.05	0.05	0.04	0.04	0.04	0.03	0.03	0.03	0.02	
±46	0.05	0.05	0.05	0.04	0.04	0.04	0.03	0.03	0.03	0.02	0.02	
±48	0.05	0.04	0.04	0.04	0.04	0.03	0.03	0.03	0.03	0.02	0.02	
±50	0.04	0.04	0.04	0.04	0.04	0.03	0.03	0.03	0.02	0.02	0.02	
±52	0.04	0.04	0.04	0.04	0.03	0.03	0.03	0.03	0.02	0.02	0.02	
±54	0.04	0.04	0.03	0.03	0.03	0.03	0.03	0.02	0.02	0.02	0.02	
±56	0.03	0.03	0.03	0.03	0.03	0.03	0.03	0.02	0.02	0.02	0.02	
±58	0.03	0.03	0.03	0.03	0.03	0.03	0.02	0.02	0.02	0.02	0.02	
±60	0.03	0.03	0.03	0.03	0.03	0.02	0.02	0.02	0.02	0.02	0.02	
±62	0.03	0.03	0.03	0.03	0.02	0.02	0.02	0.02	0.02	0.02	0.02	

Appendix Table B-4. Table of average DC magnetic fields computed for various projects at distances along and above seabed.
(continued)

Magnetic Field (microTesla)	Distance above seabed (m)											
	0	5	10	15	20	25	30	35	40	45	50	
±64	0.03	0.03	0.02	0.02	0.02	0.02	0.02	0.02	0.02	0.02	0.02	0.02
±66	0.02	0.02	0.02	0.02	0.02	0.02	0.02	0.02	0.02	0.02	0.02	0.01
±68	0.02	0.02	0.02	0.02	0.02	0.02	0.02	0.02	0.02	0.02	0.02	0.01
±70	0.02	0.02	0.02	0.02	0.02	0.02	0.02	0.02	0.02	0.02	0.01	0.01
±72	0.02	0.02	0.02	0.02	0.02	0.02	0.02	0.02	0.02	0.02	0.01	0.01
±74	0.02	0.02	0.02	0.02	0.02	0.02	0.02	0.02	0.02	0.01	0.01	0.01
±76	0.02	0.02	0.02	0.02	0.02	0.02	0.02	0.02	0.01	0.01	0.01	0.01
±78	0.02	0.02	0.02	0.02	0.02	0.02	0.02	0.01	0.01	0.01	0.01	0.01
±80	0.02	0.02	0.02	0.02	0.02	0.02	0.01	0.01	0.01	0.01	0.01	0.01
±82	0.02	0.02	0.02	0.01	0.01	0.01	0.01	0.01	0.01	0.01	0.01	0.01
±84	0.01	0.01	0.01	0.01	0.01	0.01	0.01	0.01	0.01	0.01	0.01	0.01
±86	0.01	0.01	0.01	0.01	0.01	0.01	0.01	0.01	0.01	0.01	0.01	0.01
±88	0.01	0.01	0.01	0.01	0.01	0.01	0.01	0.01	0.01	0.01	0.01	0.01
±90	0.01	0.01	0.01	0.01	0.01	0.01	0.01	0.01	0.01	0.01	0.01	0.01
±92	0.01	0.01	0.01	0.01	0.01	0.01	0.01	0.01	0.01	0.01	0.01	0.01
±94	0.01	0.01	0.01	0.01	0.01	0.01	0.01	0.01	0.01	0.01	0.01	0.01
±96	0.01	0.01	0.01	0.01	0.01	0.01	0.01	0.01	0.01	0.01	0.01	0.01
±98	0.01	0.01	0.01	0.01	0.01	0.01	0.01	0.01	0.01	0.01	0.01	0.01
±100	0.01	0.01	0.01	0.01	0.01	0.01	0.01	0.01	0.01	0.01	0.01	0.01

Appendix Table B-5.

Average induced electric field computed for various projects with DC undersea cables at distances along and above seabed for a sea current of 5 knots flowing parallel to the cables.

Induced Electric Field (V/m)	Distance above seabed (m)											
	0	5	10	15	20	25	30	35	40	45	50	
Distance along seabed (m)	0	1.94E-04	1.75E-05	8.80E-06	5.19E-06	3.35E-06	2.31E-06	1.68E-06	1.27E-06	9.96E-07	7.99E-07	6.55E-07
	±2	6.04E-05	1.70E-05	8.73E-06	5.15E-06	3.33E-06	2.30E-06	1.68E-06	1.27E-06	9.94E-07	7.98E-07	6.54E-07
	±4	3.15E-05	1.62E-05	8.52E-06	5.05E-06	3.28E-06	2.27E-06	1.66E-06	1.26E-06	9.88E-07	7.94E-07	6.51E-07
	±6	2.94E-05	1.56E-05	8.18E-06	4.88E-06	3.19E-06	2.23E-06	1.63E-06	1.24E-06	9.78E-07	7.87E-07	6.47E-07
	±8	4.14E-05	1.50E-05	7.72E-06	4.65E-06	3.08E-06	2.17E-06	1.60E-06	1.22E-06	9.64E-07	7.78E-07	6.41E-07
	±10	7.85E-05	1.39E-05	7.13E-06	4.38E-06	2.94E-06	2.09E-06	1.55E-06	1.20E-06	9.47E-07	7.67E-07	6.33E-07
	±12	3.26E-05	1.19E-05	6.43E-06	4.06E-06	2.78E-06	2.00E-06	1.50E-06	1.17E-06	9.27E-07	7.54E-07	6.24E-07
	±14	1.66E-05	9.56E-06	5.67E-06	3.72E-06	2.60E-06	1.91E-06	1.45E-06	1.13E-06	9.04E-07	7.38E-07	6.13E-07
	±16	1.06E-05	7.54E-06	4.93E-06	3.38E-06	2.43E-06	1.81E-06	1.39E-06	1.09E-06	8.79E-07	7.21E-07	6.01E-07
	±18	7.48E-06	5.98E-06	4.25E-06	3.05E-06	2.25E-06	1.70E-06	1.32E-06	1.05E-06	8.52E-07	7.03E-07	5.88E-07
	±20	5.64E-06	4.81E-06	3.66E-06	2.73E-06	2.07E-06	1.60E-06	1.26E-06	1.01E-06	8.24E-07	6.83E-07	5.74E-07
	±22	4.44E-06	3.94E-06	3.16E-06	2.45E-06	1.90E-06	1.49E-06	1.19E-06	9.66E-07	7.95E-07	6.63E-07	5.60E-07
	±24	3.60E-06	3.29E-06	2.73E-06	2.19E-06	1.74E-06	1.39E-06	1.13E-06	9.23E-07	7.65E-07	6.42E-07	5.45E-07
	±26	2.99E-06	2.78E-06	2.38E-06	1.96E-06	1.60E-06	1.30E-06	1.06E-06	8.80E-07	7.35E-07	6.20E-07	5.29E-07
	±28	2.53E-06	2.38E-06	2.09E-06	1.76E-06	1.46E-06	1.21E-06	1.00E-06	8.37E-07	7.05E-07	5.99E-07	5.13E-07
	±30	2.17E-06	2.06E-06	1.84E-06	1.59E-06	1.34E-06	1.12E-06	9.43E-07	7.95E-07	6.75E-07	5.77E-07	4.97E-07
	±32	1.88E-06	1.80E-06	1.63E-06	1.43E-06	1.23E-06	1.04E-06	8.87E-07	7.55E-07	6.45E-07	5.55E-07	4.81E-07
	±34	1.65E-06	1.59E-06	1.46E-06	1.30E-06	1.13E-06	9.72E-07	8.34E-07	7.16E-07	6.17E-07	5.34E-07	4.64E-07
	±36	1.46E-06	1.41E-06	1.31E-06	1.18E-06	1.04E-06	9.04E-07	7.84E-07	6.79E-07	5.89E-07	5.13E-07	4.48E-07
	±38	1.30E-06	1.26E-06	1.18E-06	1.07E-06	9.57E-07	8.42E-07	7.37E-07	6.43E-07	5.62E-07	4.92E-07	4.33E-07
	±40	1.16E-06	1.13E-06	1.07E-06	9.81E-07	8.83E-07	7.85E-07	6.93E-07	6.10E-07	5.36E-07	4.72E-07	4.17E-07
	±42	1.05E-06	1.03E-06	9.73E-07	9.00E-07	8.17E-07	7.33E-07	6.52E-07	5.78E-07	5.11E-07	4.53E-07	4.02E-07
	±44	9.52E-07	9.33E-07	8.89E-07	8.28E-07	7.58E-07	6.85E-07	6.14E-07	5.47E-07	4.87E-07	4.34E-07	3.87E-07
	±46	8.68E-07	8.52E-07	8.15E-07	7.64E-07	7.04E-07	6.41E-07	5.78E-07	5.19E-07	4.65E-07	4.16E-07	3.73E-07
	±48	7.94E-07	7.81E-07	7.50E-07	7.07E-07	6.55E-07	6.00E-07	5.45E-07	4.92E-07	4.43E-07	3.99E-07	3.59E-07
	±50	7.30E-07	7.18E-07	6.93E-07	6.56E-07	6.11E-07	5.63E-07	5.14E-07	4.67E-07	4.23E-07	3.82E-07	3.45E-07
	±52	6.73E-07	6.63E-07	6.41E-07	6.10E-07	5.71E-07	5.29E-07	4.86E-07	4.44E-07	4.03E-07	3.66E-07	3.32E-07
	±54	6.22E-07	6.14E-07	5.96E-07	5.68E-07	5.35E-07	4.98E-07	4.59E-07	4.21E-07	3.85E-07	3.51E-07	3.19E-07
	±56	5.78E-07	5.71E-07	5.54E-07	5.31E-07	5.01E-07	4.69E-07	4.35E-07	4.01E-07	3.68E-07	3.36E-07	3.07E-07
	±58	5.37E-07	5.31E-07	5.17E-07	4.97E-07	4.71E-07	4.42E-07	4.12E-07	3.81E-07	3.51E-07	3.22E-07	2.96E-07
±60	5.01E-07	4.96E-07	4.84E-07	4.66E-07	4.43E-07	4.18E-07	3.90E-07	3.63E-07	3.35E-07	3.09E-07	2.85E-07	

Appendix Table B-5. Average induced electric field computed for various projects with DC undersea cables at distances along and above seabed for a sea current of 5 knots flowing parallel to the cables. (continued)

Induced Electric Field (V/m)	Distance above seabed (m)										
	0	5	10	15	20	25	30	35	40	45	50
±62	4.69E-07	4.64E-07	4.54E-07	4.38E-07	4.18E-07	3.95E-07	3.70E-07	3.45E-07	3.21E-07	2.97E-07	2.74E-07
±64	4.39E-07	4.35E-07	4.26E-07	4.12E-07	3.94E-07	3.74E-07	3.52E-07	3.29E-07	3.07E-07	2.85E-07	2.64E-07
±66	4.13E-07	4.09E-07	4.01E-07	3.88E-07	3.73E-07	3.54E-07	3.35E-07	3.14E-07	2.94E-07	2.73E-07	2.54E-07
±68	3.88E-07	3.85E-07	3.78E-07	3.67E-07	3.53E-07	3.36E-07	3.19E-07	3.00E-07	2.81E-07	2.63E-07	2.45E-07
±70	3.66E-07	3.63E-07	3.57E-07	3.47E-07	3.34E-07	3.20E-07	3.03E-07	2.87E-07	2.69E-07	2.52E-07	2.36E-07
±72	3.46E-07	3.43E-07	3.37E-07	3.29E-07	3.17E-07	3.04E-07	2.89E-07	2.74E-07	2.58E-07	2.42E-07	2.27E-07
±74	3.27E-07	3.25E-07	3.19E-07	3.12E-07	3.01E-07	2.89E-07	2.76E-07	2.62E-07	2.48E-07	2.33E-07	2.19E-07
±76	3.10E-07	3.08E-07	3.03E-07	2.96E-07	2.87E-07	2.76E-07	2.64E-07	2.51E-07	2.38E-07	2.24E-07	2.11E-07
±78	2.94E-07	2.92E-07	2.88E-07	2.81E-07	2.73E-07	2.63E-07	2.52E-07	2.40E-07	2.28E-07	2.16E-07	2.04E-07
±80	2.79E-07	2.77E-07	2.74E-07	2.68E-07	2.60E-07	2.51E-07	2.41E-07	2.31E-07	2.19E-07	2.08E-07	1.96E-07
±82	2.65E-07	2.64E-07	2.61E-07	2.55E-07	2.48E-07	2.40E-07	2.31E-07	2.21E-07	2.11E-07	2.00E-07	1.90E-07
±84	2.53E-07	2.51E-07	2.48E-07	2.44E-07	2.37E-07	2.30E-07	2.22E-07	2.12E-07	2.03E-07	1.93E-07	1.83E-07
±86	2.41E-07	2.40E-07	2.37E-07	2.33E-07	2.27E-07	2.20E-07	2.12E-07	2.04E-07	1.95E-07	1.86E-07	1.77E-07
±88	2.30E-07	2.29E-07	2.26E-07	2.22E-07	2.17E-07	2.11E-07	2.04E-07	1.96E-07	1.88E-07	1.80E-07	1.71E-07
±90	2.20E-07	2.19E-07	2.16E-07	2.13E-07	2.08E-07	2.02E-07	1.96E-07	1.89E-07	1.81E-07	1.73E-07	1.65E-07
±92	2.10E-07	2.09E-07	2.07E-07	2.04E-07	2.00E-07	1.94E-07	1.88E-07	1.82E-07	1.75E-07	1.67E-07	1.60E-07
±94	2.01E-07	2.00E-07	1.99E-07	1.95E-07	1.91E-07	1.87E-07	1.81E-07	1.75E-07	1.68E-07	1.62E-07	1.55E-07
±96	1.93E-07	1.92E-07	1.90E-07	1.88E-07	1.84E-07	1.79E-07	1.74E-07	1.69E-07	1.63E-07	1.56E-07	1.50E-07
±98	1.85E-07	1.84E-07	1.83E-07	1.80E-07	1.77E-07	1.73E-07	1.68E-07	1.63E-07	1.57E-07	1.51E-07	1.45E-07
±100	1.78E-07	1.77E-07	1.76E-07	1.73E-07	1.70E-07	1.66E-07	1.62E-07	1.57E-07	1.52E-07	1.46E-07	1.40E-07

Appendix Table B-6.

Average induced electric field computed for various projects with DC undersea cables at distances along and above seabed for a sea current of 5 knots flowing perpendicular to the cables.

Induced Electric Field (V/m) ^a	Distance above seabed (m)										
	0	5	10	15	20	25	30	35	40	45	50
0	1.94E-04	1.75E-05	8.80E-06	5.19E-06	3.35E-06	2.31E-06	1.68E-06	1.27E-06	9.96E-07	7.99E-07	6.55E-07
±2	3.81E-05	1.57E-05	8.48E-06	5.06E-06	3.29E-06	2.28E-06	1.66E-06	1.26E-06	9.90E-07	7.95E-07	6.52E-07
±4	2.92E-05	1.27E-05	7.58E-06	4.68E-06	3.11E-06	2.19E-06	1.61E-06	1.23E-06	9.71E-07	7.83E-07	6.44E-07
±6	2.85E-05	1.01E-05	6.27E-06	4.11E-06	2.83E-06	2.05E-06	1.53E-06	1.19E-06	9.41E-07	7.63E-07	6.30E-07
±8	3.82E-05	8.21E-06	4.71E-06	3.39E-06	2.48E-06	1.86E-06	1.43E-06	1.12E-06	9.00E-07	7.36E-07	6.12E-07
±10	6.07E-06	4.27E-06	3.04E-06	2.62E-06	2.09E-06	1.64E-06	1.30E-06	1.04E-06	8.50E-07	7.03E-07	5.89E-07
±12	2.86E-05	1.34E-06	1.62E-06	1.85E-06	1.68E-06	1.41E-06	1.16E-06	9.56E-07	7.93E-07	6.64E-07	5.62E-07
±14	1.59E-05	3.56E-06	5.63E-07	1.15E-06	1.28E-06	1.17E-06	1.01E-06	8.61E-07	7.30E-07	6.21E-07	5.32E-07
±16	1.03E-05	4.17E-06	6.41E-07	5.65E-07	9.07E-07	9.38E-07	8.65E-07	7.64E-07	6.64E-07	5.75E-07	4.99E-07
±18	7.38E-06	4.01E-06	1.17E-06	1.90E-07	5.84E-07	7.22E-07	7.20E-07	6.65E-07	5.96E-07	5.27E-07	4.65E-07
±20	5.60E-06	3.61E-06	1.45E-06	2.38E-07	3.12E-07	5.26E-07	5.82E-07	5.69E-07	5.28E-07	4.78E-07	4.29E-07
±22	4.41E-06	3.17E-06	1.55E-06	4.76E-07	1.11E-07	3.54E-07	4.56E-07	4.77E-07	4.61E-07	4.29E-07	3.92E-07
±24	3.59E-06	2.76E-06	1.55E-06	6.32E-07	8.13E-08	2.07E-07	3.41E-07	3.91E-07	3.96E-07	3.81E-07	3.56E-07
±26	2.98E-06	2.41E-06	1.50E-06	7.26E-07	2.13E-07	8.41E-08	2.40E-07	3.11E-07	3.35E-07	3.34E-07	3.20E-07
±28	2.52E-06	2.12E-06	1.42E-06	7.75E-07	3.09E-07	1.66E-08	1.51E-07	2.39E-07	2.78E-07	2.89E-07	2.85E-07
±30	2.16E-06	1.87E-06	1.33E-06	7.93E-07	3.78E-07	9.75E-08	7.53E-08	1.74E-07	2.25E-07	2.46E-07	2.51E-07
±32	1.87E-06	1.65E-06	1.23E-06	7.91E-07	4.24E-07	1.61E-07	1.74E-08	1.17E-07	1.76E-07	2.07E-07	2.18E-07
±34	1.64E-06	1.47E-06	1.14E-06	7.74E-07	4.53E-07	2.10E-07	4.22E-08	6.64E-08	1.32E-07	1.70E-07	1.88E-07
±36	1.45E-06	1.32E-06	1.06E-06	7.49E-07	4.69E-07	2.47E-07	8.61E-08	2.31E-08	9.32E-08	1.36E-07	1.59E-07
±38	1.30E-06	1.19E-06	9.77E-07	7.19E-07	4.75E-07	2.74E-07	1.22E-07	1.40E-08	5.83E-08	1.05E-07	1.32E-07
±40	1.16E-06	1.08E-06	9.03E-07	6.87E-07	4.74E-07	2.93E-07	1.50E-07	4.55E-08	2.77E-08	7.65E-08	1.08E-07
±42	1.05E-06	9.81E-07	8.36E-07	6.53E-07	4.68E-07	3.05E-07	1.72E-07	7.19E-08	3.54E-09	5.13E-08	8.48E-08
±44	9.51E-07	8.95E-07	7.75E-07	6.20E-07	4.59E-07	3.12E-07	1.90E-07	9.38E-08	2.24E-08	2.87E-08	6.41E-08
±46	8.67E-07	8.21E-07	7.20E-07	5.87E-07	4.47E-07	3.15E-07	2.02E-07	1.12E-07	4.25E-08	8.72E-09	4.52E-08
±48	7.93E-07	7.55E-07	6.70E-07	5.56E-07	4.33E-07	3.15E-07	2.12E-07	1.26E-07	5.96E-08	8.95E-09	2.82E-08
±50	7.29E-07	6.96E-07	6.24E-07	5.26E-07	4.18E-07	3.12E-07	2.18E-07	1.38E-07	7.41E-08	2.44E-08	1.28E-08
±52	6.72E-07	6.45E-07	5.83E-07	4.98E-07	4.03E-07	3.08E-07	2.22E-07	1.47E-07	8.63E-08	3.80E-08	8.75E-10
±54	6.22E-07	5.98E-07	5.45E-07	4.71E-07	3.87E-07	3.03E-07	2.24E-07	1.54E-07	9.64E-08	4.97E-08	1.31E-08
±56	5.77E-07	5.57E-07	5.11E-07	4.46E-07	3.72E-07	2.96E-07	2.24E-07	1.59E-07	1.05E-07	5.98E-08	2.39E-08
±58	5.37E-07	5.19E-07	4.80E-07	4.23E-07	3.57E-07	2.89E-07	2.23E-07	1.63E-07	1.12E-07	6.84E-08	3.35E-08
±60	5.01E-07	4.86E-07	4.51E-07	4.01E-07	3.42E-07	2.81E-07	2.21E-07	1.65E-07	1.17E-07	7.57E-08	4.18E-08

Appendix Table B-6. Average induced electric field computed for various projects with DC undersea cables at distances along and above seabed for a sea current of 5 knots flowing perpendicular to the cables. (continued)

Induced Electric Field (V/m)	Distance above seabed (m)										
	0	5	10	15	20	25	30	35	40	45	50
±62	4.68E-07	4.55E-07	4.25E-07	3.81E-07	3.28E-07	2.73E-07	2.18E-07	1.67E-07	1.21E-07	8.19E-08	4.91E-08
±64	4.39E-07	4.27E-07	4.00E-07	3.61E-07	3.15E-07	2.64E-07	2.14E-07	1.67E-07	1.24E-07	8.70E-08	5.55E-08
±66	4.12E-07	4.02E-07	3.78E-07	3.44E-07	3.02E-07	2.56E-07	2.10E-07	1.66E-07	1.27E-07	9.12E-08	6.10E-08
±68	3.88E-07	3.79E-07	3.58E-07	3.27E-07	2.89E-07	2.48E-07	2.06E-07	1.65E-07	1.28E-07	9.46E-08	6.57E-08
±70	3.66E-07	3.58E-07	3.39E-07	3.11E-07	2.77E-07	2.40E-07	2.01E-07	1.64E-07	1.29E-07	9.73E-08	6.96E-08
±72	3.45E-07	3.38E-07	3.21E-07	2.97E-07	2.66E-07	2.32E-07	1.97E-07	1.62E-07	1.29E-07	9.94E-08	7.30E-08
±74	3.27E-07	3.20E-07	3.05E-07	2.83E-07	2.55E-07	2.24E-07	1.92E-07	1.60E-07	1.29E-07	1.01E-07	7.58E-08
±76	3.09E-07	3.04E-07	2.90E-07	2.70E-07	2.45E-07	2.17E-07	1.87E-07	1.57E-07	1.28E-07	1.02E-07	7.80E-08
±78	2.94E-07	2.88E-07	2.76E-07	2.58E-07	2.35E-07	2.09E-07	1.82E-07	1.54E-07	1.28E-07	1.03E-07	7.99E-08
±80	2.79E-07	2.74E-07	2.63E-07	2.47E-07	2.26E-07	2.02E-07	1.77E-07	1.51E-07	1.26E-07	1.03E-07	8.13E-08
±82	2.65E-07	2.61E-07	2.51E-07	2.36E-07	2.17E-07	1.95E-07	1.72E-07	1.48E-07	1.25E-07	1.03E-07	8.23E-08
±84	2.53E-07	2.49E-07	2.40E-07	2.26E-07	2.09E-07	1.89E-07	1.67E-07	1.45E-07	1.23E-07	1.03E-07	8.31E-08
±86	2.41E-07	2.37E-07	2.29E-07	2.17E-07	2.01E-07	1.82E-07	1.63E-07	1.42E-07	1.22E-07	1.02E-07	8.36E-08
±88	2.30E-07	2.27E-07	2.19E-07	2.08E-07	1.93E-07	1.76E-07	1.58E-07	1.39E-07	1.20E-07	1.01E-07	8.38E-08
±90	2.20E-07	2.17E-07	2.10E-07	2.00E-07	1.86E-07	1.71E-07	1.54E-07	1.36E-07	1.18E-07	1.00E-07	8.39E-08
±92	2.10E-07	2.08E-07	2.01E-07	1.92E-07	1.79E-07	1.65E-07	1.49E-07	1.33E-07	1.16E-07	9.94E-08	8.37E-08
±94	2.01E-07	1.99E-07	1.93E-07	1.84E-07	1.73E-07	1.60E-07	1.45E-07	1.29E-07	1.14E-07	9.83E-08	8.34E-08
±96	1.93E-07	1.91E-07	1.85E-07	1.77E-07	1.67E-07	1.54E-07	1.41E-07	1.26E-07	1.12E-07	9.71E-08	8.30E-08
±98	1.85E-07	1.83E-07	1.78E-07	1.71E-07	1.61E-07	1.50E-07	1.37E-07	1.23E-07	1.10E-07	9.58E-08	8.24E-08
±100	1.78E-07	1.76E-07	1.71E-07	1.64E-07	1.55E-07	1.45E-07	1.33E-07	1.20E-07	1.07E-07	9.44E-08	8.17E-08

^aThis table represents the average of model results for nine DC cable systems.

Appendix Table B-7.

DC magnetic field (per 1000 Amperes of balanced current) calculated for cables buried 1 m below the seabed surface, and separated by 0.5 m.

Magnetic Field ^a (microTesla)	Distance above seabed (m)										
	0	5	10	15	20	25	30	35	40	45	50
0	94.1	2.77	8.26E-1	3.91E-1	2.27E-1	1.48E-1	1.04E-1	7.72E-2	5.95E-2	4.73E-2	3.84E-2
±2	20.2	2.50	8.00E-1	3.85E-1	2.25E-1	1.47E-1	1.04E-1	7.69E-2	5.93E-2	4.72E-2	3.84E-2
±4	5.90	1.92	7.30E-1	3.68E-1	2.19E-1	1.44E-1	1.02E-1	7.62E-2	5.89E-2	4.69E-2	3.82E-2
±6	2.71	1.39	6.37E-1	3.42E-1	2.10E-1	1.40E-1	1.00E-1	7.51E-2	5.82E-2	4.65E-2	3.79E-2
±8	1.54	1.00	5.40E-1	3.12E-1	1.98E-1	1.35E-1	9.76E-2	7.35E-2	5.73E-2	4.59E-2	3.75E-2
±10	9.91E-1	7.35E-1	4.52E-1	2.81E-1	1.85E-1	1.29E-1	9.42E-2	7.16E-2	5.61E-2	4.51E-2	3.70E-2
±12	6.90E-1	5.56E-1	3.77E-1	2.50E-1	1.71E-1	1.22E-1	9.05E-2	6.94E-2	5.48E-2	4.42E-2	3.64E-2
±14	5.08E-1	4.31E-1	3.15E-1	2.21E-1	1.57E-1	1.15E-1	8.64E-2	6.70E-2	5.33E-2	4.33E-2	3.58E-2
±16	3.89E-1	3.43E-1	2.65E-1	1.95E-1	1.43E-1	1.07E-1	8.22E-2	6.44E-2	5.16E-2	4.22E-2	3.50E-2
±18	3.08E-1	2.78E-1	2.25E-1	1.72E-1	1.31E-1	1.00E-1	7.78E-2	6.17E-2	4.99E-2	4.10E-2	3.42E-2
±20	2.49E-1	2.29E-1	1.92E-1	1.52E-1	1.19E-1	9.29E-2	7.35E-2	5.90E-2	4.81E-2	3.97E-2	3.33E-2
±22	2.06E-1	1.92E-1	1.65E-1	1.35E-1	1.08E-1	8.62E-2	6.92E-2	5.62E-2	4.62E-2	3.85E-2	3.24E-2
±24	1.73E-1	1.63E-1	1.43E-1	1.20E-1	9.83E-2	7.99E-2	6.51E-2	5.34E-2	4.43E-2	3.71E-2	3.15E-2
±26	1.48E-1	1.40E-1	1.25E-1	1.07E-1	8.95E-2	7.40E-2	6.11E-2	5.07E-2	4.24E-2	3.58E-2	3.05E-2
±28	1.27E-1	1.22E-1	1.11E-1	9.62E-2	8.16E-2	6.85E-2	5.73E-2	4.81E-2	4.06E-2	3.45E-2	2.95E-2
±30	1.11E-1	1.07E-1	9.79E-2	8.65E-2	7.46E-2	6.35E-2	5.37E-2	4.55E-2	3.87E-2	3.32E-2	2.86E-2
±32	9.76E-2	9.43E-2	8.73E-2	7.81E-2	6.83E-2	5.88E-2	5.04E-2	4.31E-2	3.70E-2	3.18E-2	2.76E-2
±34	8.64E-2	8.39E-2	7.83E-2	7.08E-2	6.26E-2	5.46E-2	4.72E-2	4.08E-2	3.52E-2	3.06E-2	2.66E-2
±36	7.71E-2	7.51E-2	7.06E-2	6.44E-2	5.76E-2	5.07E-2	4.43E-2	3.86E-2	3.36E-2	2.93E-2	2.57E-2
±38	6.92E-2	6.76E-2	6.39E-2	5.88E-2	5.31E-2	4.72E-2	4.16E-2	3.65E-2	3.20E-2	2.81E-2	2.47E-2
±40	6.25E-2	6.11E-2	5.81E-2	5.39E-2	4.90E-2	4.39E-2	3.90E-2	3.45E-2	3.05E-2	2.69E-2	2.38E-2
±42	5.67E-2	5.56E-2	5.31E-2	4.95E-2	4.54E-2	4.10E-2	3.67E-2	3.27E-2	2.90E-2	2.58E-2	2.29E-2
±44	5.16E-2	5.07E-2	4.86E-2	4.56E-2	4.21E-2	3.83E-2	3.45E-2	3.09E-2	2.76E-2	2.47E-2	2.20E-2
±46	4.72E-2	4.65E-2	4.47E-2	4.22E-2	3.91E-2	3.58E-2	3.25E-2	2.93E-2	2.63E-2	2.36E-2	2.12E-2
±48	4.34E-2	4.27E-2	4.12E-2	3.91E-2	3.64E-2	3.36E-2	3.06E-2	2.78E-2	2.51E-2	2.26E-2	2.04E-2
±50	4.00E-2	3.94E-2	3.82E-2	3.63E-2	3.40E-2	3.15E-2	2.89E-2	2.63E-2	2.39E-2	2.17E-2	1.96E-2
±52	3.70E-2	3.65E-2	3.54E-2	3.38E-2	3.18E-2	2.96E-2	2.73E-2	2.50E-2	2.28E-2	2.07E-2	1.89E-2
±54	3.43E-2	3.39E-2	3.29E-2	3.15E-2	2.98E-2	2.78E-2	2.58E-2	2.37E-2	2.18E-2	1.99E-2	1.81E-2
±56	3.19E-2	3.15E-2	3.07E-2	2.95E-2	2.80E-2	2.62E-2	2.44E-2	2.26E-2	2.08E-2	1.90E-2	1.74E-2
±58	2.97E-2	2.94E-2	2.87E-2	2.76E-2	2.63E-2	2.48E-2	2.31E-2	2.15E-2	1.98E-2	1.82E-2	1.68E-2
±60	2.78E-2	2.75E-2	2.69E-2	2.59E-2	2.47E-2	2.34E-2	2.19E-2	2.04E-2	1.89E-2	1.75E-2	1.61E-2
±62	2.60E-2	2.58E-2	2.52E-2	2.44E-2	2.33E-2	2.21E-2	2.08E-2	1.95E-2	1.81E-2	1.68E-2	1.55E-2
±64	2.44E-2	2.42E-2	2.37E-2	2.30E-2	2.20E-2	2.10E-2	1.98E-2	1.85E-2	1.73E-2	1.61E-2	1.49E-2
±66	2.30E-2	2.28E-2	2.23E-2	2.17E-2	2.08E-2	1.99E-2	1.88E-2	1.77E-2	1.66E-2	1.55E-2	1.44E-2

Appendix Table B-7. DC magnetic field (per 1000 Amperes of balanced current) calculated for cables buried 1 m below the seabed surface, and separated by 0.5 m. (continued)

Magnetic Field ^a (microTesla)	Distance above seabed (m)										
	0	5	10	15	20	25	30	35	40	45	50
±68	2.16E-2	2.15E-2	2.11E-2	2.05E-2	1.97E-2	1.89E-2	1.79E-2	1.69E-2	1.59E-2	1.48E-2	1.38E-2
±70	2.04E-2	2.03E-2	1.99E-2	1.94E-2	1.87E-2	1.79E-2	1.71E-2	1.61E-2	1.52E-2	1.43E-2	1.33E-2
±72	1.93E-2	1.92E-2	1.89E-2	1.84E-2	1.78E-2	1.71E-2	1.63E-2	1.54E-2	1.46E-2	1.37E-2	1.28E-2
±74	1.83E-2	1.81E-2	1.79E-2	1.74E-2	1.69E-2	1.63E-2	1.55E-2	1.48E-2	1.40E-2	1.32E-2	1.24E-2
±76	1.73E-2	1.72E-2	1.70E-2	1.66E-2	1.61E-2	1.55E-2	1.48E-2	1.41E-2	1.34E-2	1.27E-2	1.19E-2
±78	1.64E-2	1.63E-2	1.61E-2	1.58E-2	1.53E-2	1.48E-2	1.42E-2	1.36E-2	1.29E-2	1.22E-2	1.15E-2
±80	1.56E-2	1.55E-2	1.53E-2	1.50E-2	1.46E-2	1.41E-2	1.36E-2	1.30E-2	1.24E-2	1.17E-2	1.11E-2
±82	1.49E-2	1.48E-2	1.46E-2	1.43E-2	1.40E-2	1.35E-2	1.30E-2	1.25E-2	1.19E-2	1.13E-2	1.07E-2
±84	1.42E-2	1.41E-2	1.39E-2	1.37E-2	1.33E-2	1.29E-2	1.25E-2	1.20E-2	1.14E-2	1.09E-2	1.04E-2
±86	1.35E-2	1.35E-2	1.33E-2	1.31E-2	1.28E-2	1.24E-2	1.20E-2	1.15E-2	1.10E-2	1.05E-2	1.00E-2
±88	1.29E-2	1.29E-2	1.27E-2	1.25E-2	1.22E-2	1.19E-2	1.15E-2	1.11E-2	1.06E-2	1.01E-2	9.67E-3
±90	1.23E-2	1.23E-2	1.22E-2	1.20E-2	1.17E-2	1.14E-2	1.10E-2	1.06E-2	1.02E-2	9.79E-3	9.34E-3
±92	1.18E-2	1.18E-2	1.16E-2	1.15E-2	1.12E-2	1.09E-2	1.06E-2	1.02E-2	9.86E-3	9.45E-3	9.04E-3
±94	1.13E-2	1.13E-2	1.12E-2	1.10E-2	1.08E-2	1.05E-2	1.02E-2	9.87E-3	9.51E-3	9.13E-3	8.74E-3
±96	1.08E-2	1.08E-2	1.07E-2	1.06E-2	1.04E-2	1.01E-2	9.83E-3	9.51E-3	9.18E-3	8.82E-3	8.46E-3
±98	1.04E-2	1.04E-2	1.03E-2	1.01E-2	9.96E-3	9.73E-3	9.47E-3	9.17E-3	8.86E-3	8.53E-3	8.19E-3
±100	1.00E-2	9.96E-3	9.88E-3	9.75E-3	9.58E-3	9.37E-3	9.12E-3	8.85E-3	8.56E-3	8.25E-3	7.94E-3

^a To calculate the magnetic field for cable with a balanced current of y Amperes, multiply the magnetic field values below by $y/1000$.

Appendix Table B-8.

DC magnetic field (per 1000 Amperes of balanced current) calculated for cables buried 1 m below the seabed surface, and separated by 1 m.

Magnetic Field ^a (micro Tesla)	Distance above seabed (m)										
	0	5	10	15	20	25	30	35	40	45	50
0	160	5.52	1.65	7.80E-1	4.53E-1	2.96E-1	2.08E-1	1.54E-1	1.19E-1	9.45E-2	7.69E-2
±2	41.2	4.98	1.60	7.69E-1	4.49E-1	2.94E-1	2.07E-1	1.54E-1	1.19E-1	9.43E-2	7.68E-2
±4	11.9E+1	3.84	1.46	7.35E-1	4.37E-1	2.89E-1	2.05E-1	1.52E-1	1.18E-1	9.38E-2	7.64E-2
±6	5.44	2.78	1.27	6.84E-1	4.19E-1	2.81E-1	2.01E-1	1.50E-1	1.16E-1	9.29E-2	7.58E-2
±8	3.09	2.00	1.08	6.25E-1	3.96E-1	2.70E-1	1.95E-1	1.47E-1	1.15E-1	9.17E-2	7.50E-2
±10	1.99	1.47	9.05E-1	5.62E-1	3.70E-1	2.58E-1	1.88E-1	1.43E-1	1.12E-1	9.02E-2	7.40E-2
±12	1.38	1.11	7.55E-1	5.00E-1	3.42E-1	2.44E-1	1.81E-1	1.39E-1	1.10E-1	8.85E-2	7.29E-2
±14	1.02	8.63E-1	6.31E-1	4.42E-1	3.14E-1	2.29E-1	1.73E-1	1.34E-1	1.07E-1	8.65E-2	7.15E-2
±16	7.79E-1	6.85E-1	5.31E-1	3.91E-1	2.87E-1	2.15E-1	1.64E-1	1.29E-1	1.03E-1	8.43E-2	7.00E-2
±18	6.16E-1	5.56E-1	4.50E-1	3.45E-1	2.61E-1	2.00E-1	1.56E-1	1.23E-1	9.97E-2	8.20E-2	6.84E-2
±20	4.99E-1	4.59E-1	3.84E-1	3.05E-1	2.38E-1	1.86E-1	1.47E-1	1.18E-1	9.61E-2	7.95E-2	6.66E-2
±22	4.13E-1	3.85E-1	3.31E-1	2.70E-1	2.16E-1	1.72E-1	1.38E-1	1.12E-1	9.24E-2	7.69E-2	6.48E-2
±24	3.47E-1	3.27E-1	2.87E-1	2.40E-1	1.97E-1	1.60E-1	1.30E-1	1.07E-1	8.86E-2	7.43E-2	6.29E-2
±26	2.96E-1	2.81E-1	2.51E-1	2.15E-1	1.79E-1	1.48E-1	1.22E-1	1.01E-1	8.48E-2	7.16E-2	6.10E-2
±28	2.55E-1	2.44E-1	2.21E-1	1.92E-1	1.63E-1	1.37E-1	1.15E-1	9.62E-2	8.11E-2	6.90E-2	5.91E-2
±30	2.22E-1	2.14E-1	1.96E-1	1.73E-1	1.49E-1	1.27E-1	1.07E-1	9.11E-2	7.75E-2	6.63E-2	5.71E-2
±32	1.95E-1	1.89E-1	1.75E-1	1.56E-1	1.37E-1	1.18E-1	1.01E-1	8.62E-2	7.39E-2	6.37E-2	5.52E-2
±34	1.73E-1	1.68E-1	1.57E-1	1.42E-1	1.25E-1	1.09E-1	9.45E-2	8.16E-2	7.05E-2	6.11E-2	5.32E-2
±36	1.54E-1	1.50E-1	1.41E-1	1.29E-1	1.15E-1	1.01E-1	8.86E-2	7.72E-2	6.72E-2	5.86E-2	5.13E-2
±38	1.38E-1	1.35E-1	1.28E-1	1.18E-1	1.06E-1	9.43E-2	8.32E-2	7.30E-2	6.40E-2	5.62E-2	4.94E-2
±40	1.25E-1	1.22E-1	1.16E-1	1.08E-1	9.80E-2	8.79E-2	7.81E-2	6.91E-2	6.10E-2	5.38E-2	4.76E-2
±42	1.13E-1	1.11E-1	1.06E-1	9.90E-2	9.07E-2	8.20E-2	7.34E-2	6.54E-2	5.81E-2	5.15E-2	4.58E-2
±44	1.03E-1	1.01E-1	9.72E-2	9.12E-2	8.41E-2	7.66E-2	6.90E-2	6.19E-2	5.53E-2	4.94E-2	4.41E-2
±46	9.45E-2	9.29E-2	8.94E-2	8.43E-2	7.82E-2	7.16E-2	6.50E-2	5.86E-2	5.27E-2	4.73E-2	4.24E-2
±48	8.68E-2	8.55E-2	8.25E-2	7.81E-2	7.29E-2	6.71E-2	6.13E-2	5.56E-2	5.02E-2	4.52E-2	4.08E-2
±50	8.00E-2	7.89E-2	7.63E-2	7.26E-2	6.80E-2	6.30E-2	5.78E-2	5.27E-2	4.78E-2	4.33E-2	3.92E-2
±52	7.39E-2	7.30E-2	7.08E-2	6.76E-2	6.36E-2	5.92E-2	5.46E-2	5.00E-2	4.56E-2	4.15E-2	3.77E-2
±54	6.86E-2	6.78E-2	6.59E-2	6.31E-2	5.96E-2	5.57E-2	5.16E-2	4.75E-2	4.35E-2	3.97E-2	3.63E-2
±56	6.38E-2	6.31E-2	6.14E-2	5.90E-2	5.59E-2	5.25E-2	4.88E-2	4.51E-2	4.15E-2	3.81E-2	3.49E-2
±58	5.94E-2	5.88E-2	5.74E-2	5.53E-2	5.26E-2	4.95E-2	4.62E-2	4.29E-2	3.96E-2	3.65E-2	3.35E-2
±60	5.55E-2	5.50E-2	5.38E-2	5.19E-2	4.95E-2	4.68E-2	4.39E-2	4.09E-2	3.79E-2	3.50E-2	3.23E-2

B-18

Distance along seabed (m)

Appendix Table B-8.DC magnetic field (per 1000 Amperes of balanced current) calculated for cables buried 1 m below the seabed surface, and separated by 1 m. (continued)

Magnetic Field ^a (microTesla)	Distance above seabed (m)										
	0	5	10	15	20	25	30	35	40	45	50
±62	5.20E-2	5.15E-2	5.04E-2	4.88E-2	4.67E-2	4.42E-2	4.16E-2	3.89E-2	3.62E-2	3.36E-2	3.10E-2
±64	4.88E-2	4.84E-2	4.74E-2	4.60E-2	4.41E-2	4.19E-2	3.96E-2	3.71E-2	3.46E-2	3.22E-2	2.99E-2
±66	4.59E-2	4.55E-2	4.47E-2	4.34E-2	4.17E-2	3.97E-2	3.76E-2	3.54E-2	3.31E-2	3.09E-2	2.87E-2
±68	4.32E-2	4.29E-2	4.22E-2	4.10E-2	3.95E-2	3.77E-2	3.58E-2	3.38E-2	3.17E-2	2.97E-2	2.77E-2
±70	4.08E-2	4.05E-2	3.98E-2	3.88E-2	3.74E-2	3.59E-2	3.41E-2	3.23E-2	3.04E-2	2.85E-2	2.67E-2
±72	3.86E-2	3.83E-2	3.77E-2	3.68E-2	3.56E-2	3.41E-2	3.25E-2	3.09E-2	2.91E-2	2.74E-2	2.57E-2
±74	3.65E-2	3.63E-2	3.57E-2	3.49E-2	3.38E-2	3.25E-2	3.11E-2	2.95E-2	2.79E-2	2.63E-2	2.48E-2
±76	3.46E-2	3.44E-2	3.39E-2	3.32E-2	3.22E-2	3.10E-2	2.97E-2	2.83E-2	2.68E-2	2.53E-2	2.39E-2
±78	3.29E-2	3.27E-2	3.22E-2	3.15E-2	3.07E-2	2.96E-2	2.84E-2	2.71E-2	2.58E-2	2.44E-2	2.30E-2
±80	3.12E-2	3.11E-2	3.07E-2	3.00E-2	2.92E-2	2.83E-2	2.72E-2	2.60E-2	2.47E-2	2.35E-2	2.22E-2
±82	2.97E-2	2.96E-2	2.92E-2	2.87E-2	2.79E-2	2.70E-2	2.60E-2	2.49E-2	2.38E-2	2.26E-2	2.14E-2
±84	2.83E-2	2.82E-2	2.79E-2	2.74E-2	2.67E-2	2.59E-2	2.49E-2	2.39E-2	2.29E-2	2.18E-2	2.07E-2
±86	2.70E-2	2.69E-2	2.66E-2	2.61E-2	2.55E-2	2.48E-2	2.39E-2	2.30E-2	2.20E-2	2.10E-2	2.00E-2
±88	2.58E-2	2.57E-2	2.54E-2	2.50E-2	2.44E-2	2.38E-2	2.30E-2	2.21E-2	2.12E-2	2.03E-2	1.93E-2
±90	2.47E-2	2.46E-2	2.43E-2	2.39E-2	2.34E-2	2.28E-2	2.21E-2	2.13E-2	2.04E-2	1.96E-2	1.87E-2
±92	2.36E-2	2.35E-2	2.33E-2	2.29E-2	2.25E-2	2.19E-2	2.12E-2	2.05E-2	1.97E-2	1.89E-2	1.81E-2
±94	2.26E-2	2.25E-2	2.23E-2	2.20E-2	2.16E-2	2.10E-2	2.04E-2	1.97E-2	1.90E-2	1.83E-2	1.75E-2
±96	2.17E-2	2.16E-2	2.14E-2	2.11E-2	2.07E-2	2.02E-2	1.97E-2	1.90E-2	1.84E-2	1.76E-2	1.69E-2
±98	2.08E-2	2.07E-2	2.06E-2	2.03E-2	1.99E-2	1.95E-2	1.89E-2	1.83E-2	1.77E-2	1.71E-2	1.64E-2
±100	2.00E-2	1.99E-2	1.98E-2	1.95E-2	1.92E-2	1.87E-2	1.82E-2	1.77E-2	1.71E-2	1.65E-2	1.59E-2

^a To calculate the magnetic field for cable with a balanced current of y Amperes, multiply the magnetic field values below by $y/1000$.

Appendix Table B-9.

AC magnetic field (per 1000 Amperes of line current) calculated for cable buried 0.5 m below the seabed surface.

Magnetic Field ^a (microTesla)	Distance above seabed (m)										
	0	5	10	15	20	25	30	35	40	45	50
0	98.5	8.10E-1	2.22E-1	1.02E-1	5.83E-2	3.77E-2	2.63E-2	1.94E-2	1.49E-2	1.18E-2	9.61E-3
±2	5.77	7.15E-1	2.14E-1	1.00E-1	5.78E-2	3.74E-2	2.62E-2	1.94E-2	1.49E-2	1.18E-2	9.59E-3
±4	1.51	5.30E-1	1.94E-1	9.56E-2	5.62E-2	3.68E-2	2.59E-2	1.92E-2	1.48E-2	1.17E-2	9.55E-3
±6	6.76E-1	3.70E-1	1.68E-1	8.87E-2	5.37E-2	3.57E-2	2.54E-2	1.89E-2	1.46E-2	1.16E-2	9.47E-3
±8	3.81E-1	2.60E-1	1.41E-1	8.05E-2	5.06E-2	3.43E-2	2.46E-2	1.85E-2	1.44E-2	1.15E-2	9.37E-3
±10	2.44E-1	1.88E-1	1.17E-1	7.20E-2	4.71E-2	3.27E-2	2.38E-2	1.80E-2	1.41E-2	1.13E-2	9.24E-3
±12	1.70E-1	1.41E-1	9.64E-2	6.38E-2	4.34E-2	3.08E-2	2.28E-2	1.74E-2	1.37E-2	1.11E-2	9.09E-3
±14	1.25E-1	1.08E-1	8.00E-2	5.62E-2	3.98E-2	2.90E-2	2.18E-2	1.68E-2	1.33E-2	1.08E-2	8.92E-3
±16	9.56E-2	8.56E-2	6.69E-2	4.94E-2	3.62E-2	2.70E-2	2.07E-2	1.62E-2	1.29E-2	1.05E-2	8.73E-3
±18	7.56E-2	6.92E-2	5.64E-2	4.34E-2	3.29E-2	2.51E-2	1.95E-2	1.55E-2	1.25E-2	1.02E-2	8.52E-3
±20	6.12E-2	5.69E-2	4.80E-2	3.83E-2	2.99E-2	2.33E-2	1.84E-2	1.48E-2	1.20E-2	9.92E-3	8.30E-3
±22	5.06E-2	4.76E-2	4.12E-2	3.38E-2	2.71E-2	2.16E-2	1.73E-2	1.40E-2	1.15E-2	9.59E-3	8.07E-3
±24	4.25E-2	4.04E-2	3.57E-2	3.00E-2	2.46E-2	2.00E-2	1.63E-2	1.33E-2	1.11E-2	9.26E-3	7.84E-3
±26	3.62E-2	3.47E-2	3.12E-2	2.67E-2	2.23E-2	1.85E-2	1.53E-2	1.27E-2	1.06E-2	8.92E-3	7.59E-3
±28	3.12E-2	3.01E-2	2.74E-2	2.39E-2	2.03E-2	1.71E-2	1.43E-2	1.20E-2	1.01E-2	8.58E-3	7.35E-3
±30	2.72E-2	2.63E-2	2.43E-2	2.15E-2	1.86E-2	1.58E-2	1.34E-2	1.13E-2	9.65E-3	8.25E-3	7.10E-3
±32	2.39E-2	2.32E-2	2.16E-2	1.94E-2	1.70E-2	1.46E-2	1.25E-2	1.07E-2	9.20E-3	7.92E-3	6.85E-3
±34	2.12E-2	2.07E-2	1.93E-2	1.75E-2	1.55E-2	1.36E-2	1.17E-2	1.01E-2	8.76E-3	7.59E-3	6.61E-3
±36	1.89E-2	1.85E-2	1.74E-2	1.59E-2	1.43E-2	1.26E-2	1.10E-2	9.58E-3	8.34E-3	7.28E-3	6.37E-3
±38	1.70E-2	1.66E-2	1.58E-2	1.45E-2	1.31E-2	1.17E-2	1.03E-2	9.06E-3	7.94E-3	6.97E-3	6.13E-3
±40	1.53E-2	1.50E-2	1.43E-2	1.33E-2	1.21E-2	1.09E-2	9.68E-3	8.57E-3	7.56E-3	6.68E-3	5.90E-3
±42	1.39E-2	1.37E-2	1.31E-2	1.22E-2	1.12E-2	1.01E-2	9.09E-3	8.10E-3	7.20E-3	6.39E-3	5.68E-3
±44	1.27E-2	1.25E-2	1.20E-2	1.13E-2	1.04E-2	9.47E-3	8.55E-3	7.67E-3	6.85E-3	6.12E-3	5.46E-3
±46	1.16E-2	1.14E-2	1.10E-2	1.04E-2	9.66E-3	8.86E-3	8.04E-3	7.26E-3	6.52E-3	5.85E-3	5.25E-3
±48	1.06E-2	1.05E-2	1.01E-2	9.63E-3	8.99E-3	8.29E-3	7.58E-3	6.87E-3	6.21E-3	5.60E-3	5.05E-3
±50	9.80E-3	9.68E-3	9.39E-3	8.94E-3	8.39E-3	7.78E-3	7.14E-3	6.52E-3	5.92E-3	5.36E-3	4.85E-3
±52	9.06E-3	8.96E-3	8.71E-3	8.32E-3	7.84E-3	7.30E-3	6.74E-3	6.18E-3	5.64E-3	5.13E-3	4.66E-3
±54	8.40E-3	8.32E-3	8.10E-3	7.76E-3	7.34E-3	6.87E-3	6.37E-3	5.87E-3	5.38E-3	4.91E-3	4.48E-3
±56	7.81E-3	7.74E-3	7.55E-3	7.26E-3	6.89E-3	6.47E-3	6.03E-3	5.57E-3	5.13E-3	4.71E-3	4.31E-3
±58	7.28E-3	7.22E-3	7.05E-3	6.80E-3	6.47E-3	6.10E-3	5.71E-3	5.30E-3	4.90E-3	4.51E-3	4.14E-3
±60	6.81E-3	6.75E-3	6.60E-3	6.38E-3	6.09E-3	5.76E-3	5.41E-3	5.04E-3	4.68E-3	4.32E-3	3.98E-3

Appendix Table B-9. AC magnetic field (per 1000 Amperes of line current) calculated for cable buried 0.5 m below the seabed surface. (continued)

Magnetic Field ^a (microTesla)	Distance above seabed (m)										
	0	5	10	15	20	25	30	35	40	45	50
±62	6.37E-3	6.32E-3	6.20E-3	6.00E-3	5.75E-3	5.45E-3	5.13E-3	4.80E-3	4.47E-3	4.14E-3	3.83E-3
±64	5.98E-3	5.94E-3	5.82E-3	5.65E-3	5.43E-3	5.16E-3	4.87E-3	4.57E-3	4.27E-3	3.97E-3	3.69E-3
±66	5.62E-3	5.59E-3	5.49E-3	5.33E-3	5.13E-3	4.89E-3	4.63E-3	4.36E-3	4.09E-3	3.81E-3	3.55E-3
±68	5.30E-3	5.26E-3	5.18E-3	5.04E-3	4.86E-3	4.65E-3	4.41E-3	4.16E-3	3.91E-3	3.66E-3	3.42E-3
±70	5.00E-3	4.97E-3	4.89E-3	4.77E-3	4.61E-3	4.41E-3	4.20E-3	3.98E-3	3.75E-3	3.52E-3	3.29E-3
±72	4.73E-3	4.70E-3	4.63E-3	4.52E-3	4.37E-3	4.20E-3	4.01E-3	3.80E-3	3.59E-3	3.38E-3	3.17E-3
±74	4.47E-3	4.45E-3	4.39E-3	4.29E-3	4.16E-3	4.00E-3	3.82E-3	3.64E-3	3.44E-3	3.25E-3	3.05E-3
±76	4.24E-3	4.22E-3	4.16E-3	4.07E-3	3.95E-3	3.81E-3	3.65E-3	3.48E-3	3.30E-3	3.12E-3	2.94E-3
±78	4.03E-3	4.01E-3	3.96E-3	3.87E-3	3.77E-3	3.64E-3	3.49E-3	3.34E-3	3.17E-3	3.00E-3	2.84E-3
±80	3.83E-3	3.81E-3	3.76E-3	3.69E-3	3.59E-3	3.48E-3	3.34E-3	3.20E-3	3.05E-3	2.89E-3	2.74E-3
±82	3.64E-3	3.63E-3	3.59E-3	3.52E-3	3.43E-3	3.32E-3	3.20E-3	3.07E-3	2.93E-3	2.79E-3	2.64E-3
±84	3.47E-3	3.46E-3	3.42E-3	3.36E-3	3.28E-3	3.18E-3	3.07E-3	2.95E-3	2.82E-3	2.68E-3	2.55E-3
±86	3.31E-3	3.30E-3	3.26E-3	3.21E-3	3.13E-3	3.05E-3	2.94E-3	2.83E-3	2.71E-3	2.59E-3	2.46E-3
±88	3.16E-3	3.15E-3	3.12E-3	3.07E-3	3.00E-3	2.92E-3	2.82E-3	2.72E-3	2.61E-3	2.50E-3	2.38E-3
±90	3.02E-3	3.01E-3	2.98E-3	2.94E-3	2.88E-3	2.80E-3	2.71E-3	2.62E-3	2.52E-3	2.41E-3	2.30E-3
±92	2.89E-3	2.88E-3	2.86E-3	2.81E-3	2.76E-3	2.69E-3	2.61E-3	2.52E-3	2.42E-3	2.33E-3	2.22E-3
±94	2.77E-3	2.76E-3	2.74E-3	2.70E-3	2.65E-3	2.58E-3	2.51E-3	2.43E-3	2.34E-3	2.25E-3	2.15E-3
±96	2.66E-3	2.65E-3	2.63E-3	2.59E-3	2.54E-3	2.48E-3	2.41E-3	2.34E-3	2.26E-3	2.17E-3	2.08E-3
±98	2.55E-3	2.54E-3	2.52E-3	2.49E-3	2.44E-3	2.39E-3	2.33E-3	2.26E-3	2.18E-3	2.10E-3	2.02E-3
±100	2.45E-3	2.44E-3	2.42E-3	2.39E-3	2.35E-3	2.30E-3	2.24E-3	2.18E-3	2.10E-3	2.03E-3	1.95E-3

^a To calculate the magnetic field for cable with a line current of y Amperes, multiply the magnetic field values below by $y/1000$.

Appendix Table B-10.

AC magnetic field (per 1000 Amperes of line current) calculated for cable buried 1 m below the seabed surface.

Magnetic Field ^a (microTesla)	Distance above seabed (m)										
	0	5	10	15	20	25	30	35	40	45	50
0	24.5	6.81E-1	2.02E-1	9.57E-2	5.56E-2	3.62E-2	2.55E-2	1.89E-2	1.46E-2	1.16E-2	9.42E-3
±2	4.90	6.13E-1	1.96E-1	9.42E-2	5.51E-2	3.60E-2	2.54E-2	1.88E-2	1.45E-2	1.16E-2	9.41E-3
±4	1.44	4.71E-1	1.79E-1	9.01E-2	5.36E-2	3.54E-2	2.51E-2	1.87E-2	1.44E-2	1.15E-2	9.36E-3
±6	6.62E-1	3.40E-1	1.56E-1	8.39E-2	5.14E-2	3.44E-2	2.46E-2	1.84E-2	1.43E-2	1.14E-2	9.29E-3
±8	3.77E-1	2.45E-1	1.32E-1	7.66E-2	4.85E-2	3.31E-2	2.39E-2	1.80E-2	1.40E-2	1.12E-2	9.19E-3
±10	2.43E-1	1.80E-1	1.11E-1	6.88E-2	4.53E-2	3.16E-2	2.31E-2	1.76E-2	1.38E-2	1.11E-2	9.07E-3
±12	1.69E-1	1.36E-1	9.25E-2	6.13E-2	4.19E-2	2.99E-2	2.22E-2	1.70E-2	1.34E-2	1.08E-2	8.93E-3
±14	1.24E-1	1.06E-1	7.73E-2	5.42E-2	3.85E-2	2.81E-2	2.12E-2	1.64E-2	1.31E-2	1.06E-2	8.76E-3
±16	9.53E-2	8.39E-2	6.50E-2	4.79E-2	3.52E-2	2.63E-2	2.01E-2	1.58E-2	1.26E-2	1.03E-2	8.58E-3
±18	7.54E-2	6.81E-2	5.51E-2	4.22E-2	3.20E-2	2.45E-2	1.91E-2	1.51E-2	1.22E-2	1.00E-2	8.38E-3
±20	6.11E-2	5.62E-2	4.70E-2	3.73E-2	2.91E-2	2.28E-2	1.80E-2	1.44E-2	1.18E-2	9.74E-3	8.16E-3
±22	5.05E-2	4.71E-2	4.05E-2	3.31E-2	2.65E-2	2.11E-2	1.70E-2	1.38E-2	1.13E-2	9.42E-3	7.94E-3
±24	4.25E-2	4.00E-2	3.52E-2	2.94E-2	2.41E-2	1.96E-2	1.59E-2	1.31E-2	1.09E-2	9.10E-3	7.71E-3
±26	3.62E-2	3.44E-2	3.07E-2	2.63E-2	2.19E-2	1.81E-2	1.50E-2	1.24E-2	1.04E-2	8.78E-3	7.48E-3
±28	3.12E-2	2.99E-2	2.71E-2	2.36E-2	2.00E-2	1.68E-2	1.40E-2	1.18E-2	9.94E-3	8.45E-3	7.24E-3
±30	2.72E-2	2.62E-2	2.40E-2	2.12E-2	1.83E-2	1.55E-2	1.32E-2	1.12E-2	9.49E-3	8.12E-3	7.00E-3
±32	2.39E-2	2.31E-2	2.14E-2	1.91E-2	1.67E-2	1.44E-2	1.23E-2	1.06E-2	9.06E-3	7.80E-3	6.76E-3
±34	2.12E-2	2.06E-2	1.92E-2	1.74E-2	1.53E-2	1.34E-2	1.16E-2	9.99E-3	8.64E-3	7.49E-3	6.52E-3
±36	1.89E-2	1.84E-2	1.73E-2	1.58E-2	1.41E-2	1.24E-2	1.09E-2	9.45E-3	8.23E-3	7.18E-3	6.29E-3
±38	1.70E-2	1.66E-2	1.57E-2	1.44E-2	1.30E-2	1.16E-2	1.02E-2	8.94E-3	7.84E-3	6.88E-3	6.06E-3
±40	1.53E-2	1.50E-2	1.42E-2	1.32E-2	1.20E-2	1.08E-2	9.57E-3	8.46E-3	7.47E-3	6.59E-3	5.83E-3
±42	1.39E-2	1.36E-2	1.30E-2	1.21E-2	1.11E-2	1.00E-2	8.99E-3	8.01E-3	7.11E-3	6.31E-3	5.61E-3
±44	1.26E-2	1.24E-2	1.19E-2	1.12E-2	1.03E-2	9.38E-3	8.46E-3	7.58E-3	6.77E-3	6.05E-3	5.40E-3
±46	1.16E-2	1.14E-2	1.10E-2	1.03E-2	9.58E-3	8.78E-3	7.96E-3	7.18E-3	6.45E-3	5.79E-3	5.19E-3
±48	1.06E-2	1.05E-2	1.01E-2	9.57E-3	8.93E-3	8.22E-3	7.50E-3	6.81E-3	6.15E-3	5.54E-3	5.00E-3
±50	9.80E-3	9.66E-3	9.35E-3	8.89E-3	8.33E-3	7.71E-3	7.08E-3	6.45E-3	5.86E-3	5.31E-3	4.80E-3
±52	9.06E-3	8.94E-3	8.67E-3	8.28E-3	7.79E-3	7.25E-3	6.69E-3	6.13E-3	5.59E-3	5.08E-3	4.62E-3
±54	8.40E-3	8.30E-3	8.07E-3	7.72E-3	7.30E-3	6.82E-3	6.32E-3	5.82E-3	5.33E-3	4.87E-3	4.44E-3
±56	7.81E-3	7.72E-3	7.52E-3	7.22E-3	6.85E-3	6.43E-3	5.98E-3	5.53E-3	5.09E-3	4.67E-3	4.27E-3
±58	7.28E-3	7.21E-3	7.03E-3	6.77E-3	6.44E-3	6.06E-3	5.66E-3	5.26E-3	4.86E-3	4.47E-3	4.11E-3
±60	6.80E-3	6.74E-3	6.58E-3	6.35E-3	6.06E-3	5.73E-3	5.37E-3	5.00E-3	4.64E-3	4.29E-3	3.95E-3

B-22

Distance along seabed (m)

Appendix Table B-10. AC magnetic field (per 1000 Amperes of line current) calculated for cable buried 1 m below the seabed surface.
(continued)

Magnetic Field ^a (microTesla)	Distance above seabed (m)										
	0	5	10	15	20	25	30	35	40	45	50
±62	6.37E-3	6.31E-3	6.18E-3	5.98E-3	5.72E-3	5.42E-3	5.10E-3	4.77E-3	4.43E-3	4.11E-3	3.80E-3
±64	5.98E-3	5.93E-3	5.81E-3	5.63E-3	5.40E-3	5.13E-3	4.84E-3	4.54E-3	4.24E-3	3.94E-3	3.66E-3
±66	5.62E-3	5.58E-3	5.47E-3	5.31E-3	5.11E-3	4.87E-3	4.61E-3	4.33E-3	4.06E-3	3.79E-3	3.52E-3
±68	5.30E-3	5.26E-3	5.16E-3	5.02E-3	4.84E-3	4.62E-3	4.39E-3	4.14E-3	3.89E-3	3.64E-3	3.39E-3
±70	5.00E-3	4.96E-3	4.88E-3	4.75E-3	4.59E-3	4.39E-3	4.18E-3	3.95E-3	3.72E-3	3.49E-3	3.27E-3
±72	4.73E-3	4.69E-3	4.62E-3	4.50E-3	4.36E-3	4.18E-3	3.99E-3	3.78E-3	3.57E-3	3.36E-3	3.15E-3
±74	4.47E-3	4.45E-3	4.38E-3	4.27E-3	4.14E-3	3.98E-3	3.81E-3	3.62E-3	3.42E-3	3.23E-3	3.03E-3
±76	4.24E-3	4.22E-3	4.15E-3	4.06E-3	3.94E-3	3.80E-3	3.64E-3	3.46E-3	3.29E-3	3.10E-3	2.92E-3
±78	4.03E-3	4.00E-3	3.95E-3	3.86E-3	3.75E-3	3.62E-3	3.48E-3	3.32E-3	3.16E-3	2.99E-3	2.82E-3
±80	3.83E-3	3.81E-3	3.76E-3	3.68E-3	3.58E-3	3.46E-3	3.33E-3	3.18E-3	3.03E-3	2.88E-3	2.72E-3
±82	3.64E-3	3.62E-3	3.58E-3	3.51E-3	3.42E-3	3.31E-3	3.19E-3	3.06E-3	2.92E-3	2.77E-3	2.63E-3
±84	3.47E-3	3.45E-3	3.41E-3	3.35E-3	3.27E-3	3.17E-3	3.06E-3	2.93E-3	2.80E-3	2.67E-3	2.54E-3
±86	3.31E-3	3.30E-3	3.26E-3	3.20E-3	3.13E-3	3.04E-3	2.93E-3	2.82E-3	2.70E-3	2.58E-3	2.45E-3
±88	3.16E-3	3.15E-3	3.12E-3	3.06E-3	2.99E-3	2.91E-3	2.81E-3	2.71E-3	2.60E-3	2.48E-3	2.37E-3
±90	3.02E-3	3.01E-3	2.98E-3	2.93E-3	2.87E-3	2.79E-3	2.70E-3	2.61E-3	2.50E-3	2.40E-3	2.29E-3
±92	2.89E-3	2.88E-3	2.85E-3	2.81E-3	2.75E-3	2.68E-3	2.60E-3	2.51E-3	2.42E-3	2.32E-3	2.21E-3
±94	2.77E-3	2.76E-3	2.74E-3	2.69E-3	2.64E-3	2.58E-3	2.50E-3	2.42E-3	2.33E-3	2.24E-3	2.14E-3
±96	2.66E-3	2.65E-3	2.62E-3	2.59E-3	2.54E-3	2.48E-3	2.41E-3	2.33E-3	2.25E-3	2.16E-3	2.07E-3
±98	2.55E-3	2.54E-3	2.52E-3	2.48E-3	2.44E-3	2.38E-3	2.32E-3	2.25E-3	2.17E-3	2.09E-3	2.01E-3
±100	2.45E-3	2.44E-3	2.42E-3	2.39E-3	2.35E-3	2.29E-3	2.24E-3	2.17E-3	2.10E-3	2.02E-3	1.94E-3

^a To calculate the magnetic field for cable with a line current of y Amperes, multiply the magnetic field values below by $y/1000$.

Appendix Table B-11.

AC magnetic field (per 1000 Amperes of line current) calculated for cable buried 1.5 m below the seabed surface.

Magnetic Field ^a (microTesla)		Distance above seabed (m)										
		0	5	10	15	20	25	30	35	40	45	50
Distance along seabed (m)	0	10.9	5.80E-1	1.85E-1	9.00E-2	5.30E-2	3.49E-2	2.47E-2	1.84E-2	1.42E-2	1.13E-2	9.24E-3
	±2	3.92	5.30E-1	1.80E-1	8.87E-2	5.25E-2	3.47E-2	2.46E-2	1.83E-2	1.42E-2	1.13E-2	9.22E-3
	±4	1.34	4.21E-1	1.65E-1	8.50E-2	5.12E-2	3.41E-2	2.43E-2	1.82E-2	1.41E-2	1.12E-2	9.18E-3
	±6	6.41E-1	3.13E-1	1.46E-1	7.95E-2	4.92E-2	3.32E-2	2.38E-2	1.79E-2	1.39E-2	1.11E-2	9.11E-3
	±8	3.70E-1	2.31E-1	1.25E-1	7.29E-2	4.66E-2	3.20E-2	2.32E-2	1.75E-2	1.37E-2	1.10E-2	9.02E-3
	±10	2.40E-1	1.72E-1	1.05E-1	6.58E-2	4.36E-2	3.05E-2	2.24E-2	1.71E-2	1.34E-2	1.08E-2	8.90E-3
	±12	1.68E-1	1.32E-1	8.87E-2	5.89E-2	4.04E-2	2.90E-2	2.16E-2	1.66E-2	1.31E-2	1.06E-2	8.76E-3
	±14	1.24E-1	1.03E-1	7.46E-2	5.23E-2	3.72E-2	2.73E-2	2.06E-2	1.60E-2	1.28E-2	1.04E-2	8.60E-3
	±16	9.49E-2	8.21E-2	6.31E-2	4.64E-2	3.41E-2	2.56E-2	1.96E-2	1.54E-2	1.24E-2	1.01E-2	8.42E-3
	±18	7.51E-2	6.69E-2	5.37E-2	4.11E-2	3.12E-2	2.39E-2	1.86E-2	1.48E-2	1.20E-2	9.85E-3	8.23E-3
	±20	6.09E-2	5.54E-2	4.60E-2	3.64E-2	2.84E-2	2.22E-2	1.76E-2	1.41E-2	1.15E-2	9.56E-3	8.03E-3
	±22	5.04E-2	4.66E-2	3.98E-2	3.24E-2	2.59E-2	2.07E-2	1.66E-2	1.35E-2	1.11E-2	9.26E-3	7.81E-3
	±24	4.24E-2	3.96E-2	3.46E-2	2.89E-2	2.36E-2	1.92E-2	1.56E-2	1.28E-2	1.07E-2	8.95E-3	7.59E-3
	±26	3.61E-2	3.41E-2	3.03E-2	2.58E-2	2.15E-2	1.78E-2	1.47E-2	1.22E-2	1.02E-2	8.63E-3	7.36E-3
	±28	3.12E-2	2.97E-2	2.67E-2	2.32E-2	1.97E-2	1.65E-2	1.38E-2	1.16E-2	9.78E-3	8.32E-3	7.13E-3
	±30	2.72E-2	2.60E-2	2.37E-2	2.09E-2	1.80E-2	1.53E-2	1.29E-2	1.10E-2	9.34E-3	8.00E-3	6.90E-3
	±32	2.39E-2	2.30E-2	2.12E-2	1.89E-2	1.65E-2	1.42E-2	1.22E-2	1.04E-2	8.92E-3	7.69E-3	6.66E-3
	±34	2.12E-2	2.04E-2	1.90E-2	1.72E-2	1.51E-2	1.32E-2	1.14E-2	9.85E-3	8.51E-3	7.38E-3	6.43E-3
	±36	1.89E-2	1.83E-2	1.72E-2	1.56E-2	1.39E-2	1.23E-2	1.07E-2	9.32E-3	8.12E-3	7.08E-3	6.21E-3
	±38	1.69E-2	1.65E-2	1.55E-2	1.43E-2	1.29E-2	1.14E-2	1.01E-2	8.83E-3	7.74E-3	6.79E-3	5.98E-3
	±40	1.53E-2	1.49E-2	1.41E-2	1.31E-2	1.19E-2	1.06E-2	9.45E-3	8.36E-3	7.37E-3	6.51E-3	5.76E-3
	±42	1.39E-2	1.36E-2	1.29E-2	1.20E-2	1.10E-2	9.93E-3	8.89E-3	7.91E-3	7.03E-3	6.24E-3	5.55E-3
	±44	1.26E-2	1.24E-2	1.18E-2	1.11E-2	1.02E-2	9.29E-3	8.37E-3	7.50E-3	6.70E-3	5.98E-3	5.34E-3
	±46	1.16E-2	1.14E-2	1.09E-2	1.03E-2	9.50E-3	8.69E-3	7.88E-3	7.11E-3	6.38E-3	5.73E-3	5.14E-3
	±48	1.06E-2	1.04E-2	1.01E-2	9.51E-3	8.86E-3	8.15E-3	7.43E-3	6.74E-3	6.09E-3	5.49E-3	4.94E-3
	±50	9.79E-3	9.64E-3	9.31E-3	8.84E-3	8.27E-3	7.65E-3	7.02E-3	6.39E-3	5.80E-3	5.26E-3	4.76E-3
	±52	9.05E-3	8.92E-3	8.64E-3	8.23E-3	7.74E-3	7.19E-3	6.63E-3	6.07E-3	5.54E-3	5.03E-3	4.57E-3
	±54	8.40E-3	8.28E-3	8.04E-3	7.68E-3	7.25E-3	6.77E-3	6.27E-3	5.77E-3	5.28E-3	4.82E-3	4.40E-3
	±56	7.81E-3	7.71E-3	7.50E-3	7.19E-3	6.81E-3	6.38E-3	5.93E-3	5.48E-3	5.04E-3	4.62E-3	4.23E-3
	±58	7.28E-3	7.19E-3	7.01E-3	6.74E-3	6.40E-3	6.03E-3	5.62E-3	5.22E-3	4.82E-3	4.43E-3	4.07E-3
±60	6.80E-3	6.73E-3	6.56E-3	6.33E-3	6.03E-3	5.69E-3	5.34E-3	4.97E-3	4.60E-3	4.25E-3	3.92E-3	

Appendix Table B-11 AC magnetic field (per 1000 Amperes of line current) calculated for cable buried 1.5 m below the seabed surface. (continued)

Magnetic Field ^a (microTesla)	Distance above seabed (m)										
	0	5	10	15	20	25	30	35	40	45	50
±62	6.37E-3	6.30E-3	6.16E-3	5.95E-3	5.69E-3	5.39E-3	5.07E-3	4.73E-3	4.40E-3	4.08E-3	3.77E-3
±64	5.98E-3	5.92E-3	5.79E-3	5.61E-3	5.38E-3	5.11E-3	4.82E-3	4.51E-3	4.21E-3	3.91E-3	3.63E-3
±66	5.62E-3	5.57E-3	5.46E-3	5.29E-3	5.09E-3	4.84E-3	4.58E-3	4.31E-3	4.03E-3	3.76E-3	3.50E-3
±68	5.30E-3	5.25E-3	5.15E-3	5.00E-3	4.82E-3	4.60E-3	4.36E-3	4.11E-3	3.86E-3	3.61E-3	3.37E-3
±70	5.00E-3	4.96E-3	4.87E-3	4.74E-3	4.57E-3	4.37E-3	4.16E-3	3.93E-3	3.70E-3	3.47E-3	3.24E-3
±72	4.72E-3	4.69E-3	4.61E-3	4.49E-3	4.34E-3	4.16E-3	3.97E-3	3.76E-3	3.55E-3	3.34E-3	3.13E-3
±74	4.47E-3	4.44E-3	4.37E-3	4.26E-3	4.13E-3	3.97E-3	3.79E-3	3.60E-3	3.40E-3	3.21E-3	3.01E-3
±76	4.24E-3	4.21E-3	4.15E-3	4.05E-3	3.93E-3	3.78E-3	3.62E-3	3.45E-3	3.27E-3	3.09E-3	2.91E-3
±78	4.03E-3	4.00E-3	3.94E-3	3.85E-3	3.74E-3	3.61E-3	3.46E-3	3.30E-3	3.14E-3	2.97E-3	2.80E-3
±80	3.83E-3	3.80E-3	3.75E-3	3.67E-3	3.57E-3	3.45E-3	3.31E-3	3.17E-3	3.02E-3	2.86E-3	2.71E-3
±82	3.64E-3	3.62E-3	3.57E-3	3.50E-3	3.41E-3	3.30E-3	3.18E-3	3.04E-3	2.90E-3	2.76E-3	2.61E-3
±84	3.47E-3	3.45E-3	3.41E-3	3.34E-3	3.26E-3	3.16E-3	3.04E-3	2.92E-3	2.79E-3	2.66E-3	2.52E-3
±86	3.31E-3	3.29E-3	3.25E-3	3.20E-3	3.12E-3	3.03E-3	2.92E-3	2.81E-3	2.69E-3	2.56E-3	2.44E-3
±88	3.16E-3	3.15E-3	3.11E-3	3.06E-3	2.99E-3	2.90E-3	2.80E-3	2.70E-3	2.59E-3	2.47E-3	2.36E-3
±90	3.02E-3	3.01E-3	2.98E-3	2.93E-3	2.86E-3	2.78E-3	2.69E-3	2.60E-3	2.49E-3	2.39E-3	2.28E-3
±92	2.89E-3	2.88E-3	2.85E-3	2.80E-3	2.74E-3	2.67E-3	2.59E-3	2.50E-3	2.41E-3	2.31E-3	2.20E-3
±94	2.77E-3	2.76E-3	2.73E-3	2.69E-3	2.64E-3	2.57E-3	2.49E-3	2.41E-3	2.32E-3	2.23E-3	2.13E-3
±96	2.66E-3	2.65E-3	2.62E-3	2.58E-3	2.53E-3	2.47E-3	2.40E-3	2.32E-3	2.24E-3	2.15E-3	2.06E-3
±98	2.55E-3	2.54E-3	2.52E-3	2.48E-3	2.43E-3	2.38E-3	2.31E-3	2.24E-3	2.16E-3	2.08E-3	2.00E-3
±100	2.45E-3	2.44E-3	2.42E-3	2.39E-3	2.34E-3	2.29E-3	2.23E-3	2.16E-3	2.09E-3	2.01E-3	1.94E-3

^a To calculate the magnetic field for cable with a line current of y Amperes, multiply the magnetic field values below by $y/1000$.

Appendix Table B-12.

AC magnetic field (per 1000 Amperes of line current) calculated for cable buried 2 m below the seabed surface.

Magnetic Field ^a (microTesla)	Distance above seabed (m)										
	0	5	10	15	20	25	30	35	40	45	50
0	6.12	5.00E-1	1.70E-1	8.48E-2	5.06E-2	3.36E-2	2.39E-2	1.79E-2	1.39E-2	1.11E-2	9.06E-3
±2	3.06	4.62E-1	1.66E-1	8.36E-2	5.02E-2	3.34E-2	2.38E-2	1.78E-2	1.39E-2	1.11E-2	9.05E-3
±4	1.23	3.77E-1	1.53E-1	8.03E-2	4.90E-2	3.29E-2	2.36E-2	1.77E-2	1.38E-2	1.10E-2	9.01E-3
±6	6.13E-1	2.88E-1	1.36E-1	7.54E-2	4.71E-2	3.20E-2	2.31E-2	1.74E-2	1.36E-2	1.09E-2	8.94E-3
±8	3.60E-1	2.17E-1	1.18E-1	6.94E-2	4.47E-2	3.09E-2	2.25E-2	1.71E-2	1.34E-2	1.08E-2	8.85E-3
±10	2.36E-1	1.64E-1	1.00E-1	6.30E-2	4.20E-2	2.96E-2	2.18E-2	1.67E-2	1.31E-2	1.06E-2	8.74E-3
±12	1.66E-1	1.27E-1	8.51E-2	5.66E-2	3.90E-2	2.81E-2	2.10E-2	1.62E-2	1.28E-2	1.04E-2	8.60E-3
±14	1.23E-1	1.00E-1	7.21E-2	5.05E-2	3.60E-2	2.65E-2	2.01E-2	1.57E-2	1.25E-2	1.02E-2	8.45E-3
±16	9.42E-2	8.03E-2	6.13E-2	4.50E-2	3.31E-2	2.49E-2	1.91E-2	1.51E-2	1.21E-2	9.94E-3	8.28E-3
±18	7.47E-2	6.57E-2	5.24E-2	4.00E-2	3.03E-2	2.33E-2	1.82E-2	1.45E-2	1.17E-2	9.67E-3	8.09E-3
±20	6.06E-2	5.46E-2	4.50E-2	3.56E-2	2.77E-2	2.17E-2	1.72E-2	1.39E-2	1.13E-2	9.39E-3	7.89E-3
±22	5.02E-2	4.60E-2	3.90E-2	3.17E-2	2.53E-2	2.02E-2	1.62E-2	1.32E-2	1.09E-2	9.10E-3	7.69E-3
±24	4.22E-2	3.92E-2	3.40E-2	2.83E-2	2.31E-2	1.88E-2	1.53E-2	1.26E-2	1.05E-2	8.80E-3	7.47E-3
±26	3.60E-2	3.38E-2	2.99E-2	2.54E-2	2.11E-2	1.74E-2	1.44E-2	1.20E-2	1.00E-2	8.49E-3	7.25E-3
±28	3.11E-2	2.94E-2	2.64E-2	2.28E-2	1.93E-2	1.62E-2	1.36E-2	1.14E-2	9.62E-3	8.19E-3	7.02E-3
±30	2.71E-2	2.58E-2	2.35E-2	2.06E-2	1.77E-2	1.50E-2	1.27E-2	1.08E-2	9.20E-3	7.88E-3	6.80E-3
±32	2.38E-2	2.28E-2	2.10E-2	1.87E-2	1.62E-2	1.40E-2	1.20E-2	1.02E-2	8.79E-3	7.58E-3	6.57E-3
±34	2.11E-2	2.03E-2	1.88E-2	1.70E-2	1.49E-2	1.30E-2	1.12E-2	9.70E-3	8.39E-3	7.28E-3	6.35E-3
±36	1.88E-2	1.82E-2	1.70E-2	1.55E-2	1.38E-2	1.21E-2	1.06E-2	9.19E-3	8.01E-3	6.99E-3	6.13E-3
±38	1.69E-2	1.64E-2	1.54E-2	1.41E-2	1.27E-2	1.13E-2	9.93E-3	8.71E-3	7.64E-3	6.71E-3	5.91E-3
±40	1.53E-2	1.49E-2	1.40E-2	1.30E-2	1.18E-2	1.05E-2	9.34E-3	8.25E-3	7.28E-3	6.43E-3	5.69E-3
±42	1.39E-2	1.35E-2	1.28E-2	1.19E-2	1.09E-2	9.83E-3	8.79E-3	7.82E-3	6.94E-3	6.17E-3	5.48E-3
±44	1.26E-2	1.23E-2	1.18E-2	1.10E-2	1.01E-2	9.19E-3	8.28E-3	7.41E-3	6.62E-3	5.91E-3	5.28E-3
±46	1.16E-2	1.13E-2	1.08E-2	1.02E-2	9.42E-3	8.61E-3	7.80E-3	7.03E-3	6.31E-3	5.66E-3	5.08E-3
±48	1.06E-2	1.04E-2	1.00E-2	9.45E-3	8.79E-3	8.08E-3	7.36E-3	6.67E-3	6.02E-3	5.43E-3	4.89E-3
±50	9.78E-3	9.61E-3	9.27E-3	8.78E-3	8.21E-3	7.59E-3	6.95E-3	6.33E-3	5.75E-3	5.20E-3	4.71E-3
±52	9.05E-3	8.90E-3	8.60E-3	8.19E-3	7.69E-3	7.14E-3	6.57E-3	6.02E-3	5.48E-3	4.99E-3	4.53E-3
±54	8.39E-3	8.26E-3	8.01E-3	7.64E-3	7.21E-3	6.72E-3	6.22E-3	5.72E-3	5.24E-3	4.78E-3	4.36E-3
±56	7.80E-3	7.69E-3	7.47E-3	7.15E-3	6.77E-3	6.34E-3	5.89E-3	5.44E-3	5.00E-3	4.58E-3	4.20E-3
±58	7.27E-3	7.18E-3	6.98E-3	6.71E-3	6.37E-3	5.99E-3	5.58E-3	5.18E-3	4.78E-3	4.40E-3	4.04E-3

B-26

Distance along seabed (m)

Appendix Table B-12 AC magnetic field (per 1000 Amperes of line current) calculated for cable buried 2 m below the seabed surface.
(continued)

Magnetic Field ^a (microTesla)	Distance above seabed (m)										
	0	5	10	15	20	25	30	35	40	45	50
±60	6.80E-3	6.71E-3	6.54E-3	6.30E-3	6.00E-3	5.66E-3	5.30E-3	4.93E-3	4.57E-3	4.22E-3	3.89E-3
±62	6.37E-3	6.29E-3	6.14E-3	5.93E-3	5.66E-3	5.36E-3	5.03E-3	4.70E-3	4.37E-3	4.05E-3	3.74E-3
±64	5.98E-3	5.91E-3	5.78E-3	5.59E-3	5.35E-3	5.08E-3	4.79E-3	4.48E-3	4.18E-3	3.89E-3	3.60E-3
±66	5.62E-3	5.56E-3	5.44E-3	5.27E-3	5.06E-3	4.82E-3	4.55E-3	4.28E-3	4.00E-3	3.73E-3	3.47E-3
±68	5.29E-3	5.24E-3	5.14E-3	4.99E-3	4.80E-3	4.58E-3	4.34E-3	4.09E-3	3.84E-3	3.59E-3	3.34E-3
±70	5.00E-3	4.95E-3	4.86E-3	4.72E-3	4.55E-3	4.35E-3	4.14E-3	3.91E-3	3.68E-3	3.45E-3	3.22E-3
±72	4.72E-3	4.68E-3	4.60E-3	4.48E-3	4.32E-3	4.14E-3	3.95E-3	3.74E-3	3.53E-3	3.31E-3	3.11E-3
±74	4.47E-3	4.43E-3	4.36E-3	4.25E-3	4.11E-3	3.95E-3	3.77E-3	3.58E-3	3.38E-3	3.19E-3	3.00E-3
±76	4.24E-3	4.21E-3	4.14E-3	4.04E-3	3.91E-3	3.77E-3	3.60E-3	3.43E-3	3.25E-3	3.07E-3	2.89E-3
±78	4.02E-3	3.99E-3	3.93E-3	3.84E-3	3.73E-3	3.60E-3	3.45E-3	3.29E-3	3.12E-3	2.95E-3	2.79E-3
±80	3.83E-3	3.80E-3	3.74E-3	3.66E-3	3.56E-3	3.44E-3	3.30E-3	3.15E-3	3.00E-3	2.85E-3	2.69E-3
±82	3.64E-3	3.62E-3	3.57E-3	3.49E-3	3.40E-3	3.29E-3	3.16E-3	3.03E-3	2.89E-3	2.74E-3	2.60E-3
±84	3.47E-3	3.45E-3	3.40E-3	3.34E-3	3.25E-3	3.15E-3	3.03E-3	2.91E-3	2.78E-3	2.64E-3	2.51E-3
±86	3.31E-3	3.29E-3	3.25E-3	3.19E-3	3.11E-3	3.02E-3	2.91E-3	2.80E-3	2.67E-3	2.55E-3	2.43E-3
±88	3.16E-3	3.14E-3	3.11E-3	3.05E-3	2.98E-3	2.89E-3	2.79E-3	2.69E-3	2.58E-3	2.46E-3	2.35E-3
±90	3.02E-3	3.01E-3	2.97E-3	2.92E-3	2.85E-3	2.78E-3	2.69E-3	2.59E-3	2.48E-3	2.38E-3	2.27E-3
±92	2.89E-3	2.88E-3	2.85E-3	2.80E-3	2.74E-3	2.67E-3	2.58E-3	2.49E-3	2.40E-3	2.30E-3	2.19E-3
±94	2.77E-3	2.76E-3	2.73E-3	2.69E-3	2.63E-3	2.56E-3	2.48E-3	2.40E-3	2.31E-3	2.22E-3	2.12E-3
±96	2.66E-3	2.64E-3	2.62E-3	2.58E-3	2.53E-3	2.46E-3	2.39E-3	2.31E-3	2.23E-3	2.14E-3	2.06E-3
±98	2.55E-3	2.54E-3	2.51E-3	2.48E-3	2.43E-3	2.37E-3	2.31E-3	2.23E-3	2.16E-3	2.07E-3	1.99E-3
±100	2.45E-3	2.44E-3	2.42E-3	2.38E-3	2.34E-3	2.28E-3	2.22E-3	2.16E-3	2.08E-3	2.01E-3	1.93E-3

^a To calculate the magnetic field for cable with a line current of y Amperes, multiply the magnetic field values below by $y/1000$.

Appendix Table B-13.

Pacific electric cables to oil platforms.

Platform	Operator	Lease # P-OCSR	Destination	Length (ft)	Water Depth Range (ft)	Electrical Cable to Platform	Electrical Drilling	Electrical Provider	Capacity	Unit/Field
A, B, & C	DCOR LLC	0241	Shore	31680	160-0	Yes	Yes	SCE	34.5 kV	Dos Cuadras
A	DCOR LLC	0241	B	2640	188-190		Yes	SCE	34.5 kV	Dos Cuadras
B	DCOR LLC	0241	C	2640	190-192	Yes	Yes	SCE	34.5 kV	Dos Cuadras
Edith	DCOR LLC	0296	Shore	52800	160-0	Yes	Yes	SCE	34.5 kV	Beta
Ellen^	Beta Operating Co.	0300				Yes	No*	PLF Elly	34.5 kV	Beta
Elly	Beta Operating Co.	0300				No	No	None	N/A	Beta
Eureka	Beta Operating Co.	0301	Ellen (2)	15297 ⁺	700-265	Yes	No*	PLF Elly	34.5 kV	Beta
Gail	Venoco Inc	0205				No	Yes**	None	N/A	Santa Clara
Gilda	DCOR LLC	0216	Shore	52800	205-0	Yes	Yes	Reliant	16.5 kV	Hueneme
Gina	DCOR LLC	0202	Shore	33792	90-0	Yes	No	Reliant	16.5 kV	Hueneme
Grace	Venoco Inc	0217				No	Yes**	None	N/A	Santa Clara
Habitat	DCOR LLC	0234	P/F A	19008	290-188	Yes	No	SCE	34.5 kV	Pitas Point
Harvest	PXP	0315				No	No	None	N/A	Pt. Arguello
Henry	DCOR LLC	0240	Hillhouse	13200	173-190	Yes	Yes	SCE	34.5 kV	Dos Cuadras
Hillhouse	DCOR LLC	0240	Shore	33792	175-0	Yes	Yes	SCE	34.5 kV	Dos Cuadras
Hermosa	PXP	0316				No	No	None	N/A	Pt. Arguello
Hildalgo	PXP	0450				No	No	None	N/A	Pt. Arguello
Hogan	POO LLC	0166	Shore	20774	154-0	Yes	No*	SCE	17 kV	Carptineria
Houchin	POO LLC	0166	Hogan	3800	163-154	Yes	No*	SCE	17 kV	Carptineria
Hondo	ExxonMobil Corp	0188	Harmony (2)	47520 ⁺	842-1198	Yes	Yes	XOM	34.5 kV	Santa Ynez
Harmony	ExxonMobil Corp	0190	Shore (2)	108768 ⁺	1198-0	Yes	Yes	XOM	34.5 kV	Santa Ynez
Hertitage	ExxonMobil Corp	0182	Harmony	39072	1075-1198	Yes	Yes	XOM	34.5 kV	Santa Ynez
Heritage	ExxonMobil Corp	0182	Shore	104544	1075-0	Yes	Yes	XOM	34.5 kV	Santa Ynez
Irene	PXP	0441	Shore	49767	242-0	Yes	Yes	PG&E	34.5 kV	Pt. Pedernales

Sources: G. Shackell (1994, 2009), C. Hoffman (1997), A. Konczvald (1994, 1999), P. Finie (2009), D. Knowlson (2009), T. Bell (2009); compiled 2010.

Notes: * denotes: Diesel Electric and any new rigs will be Diesel Electric

** denotes: Electricity Derived from Platform Turbine Engines

^ connects to Elly by bridge, no sub-sea cable

+includes total length of both cables

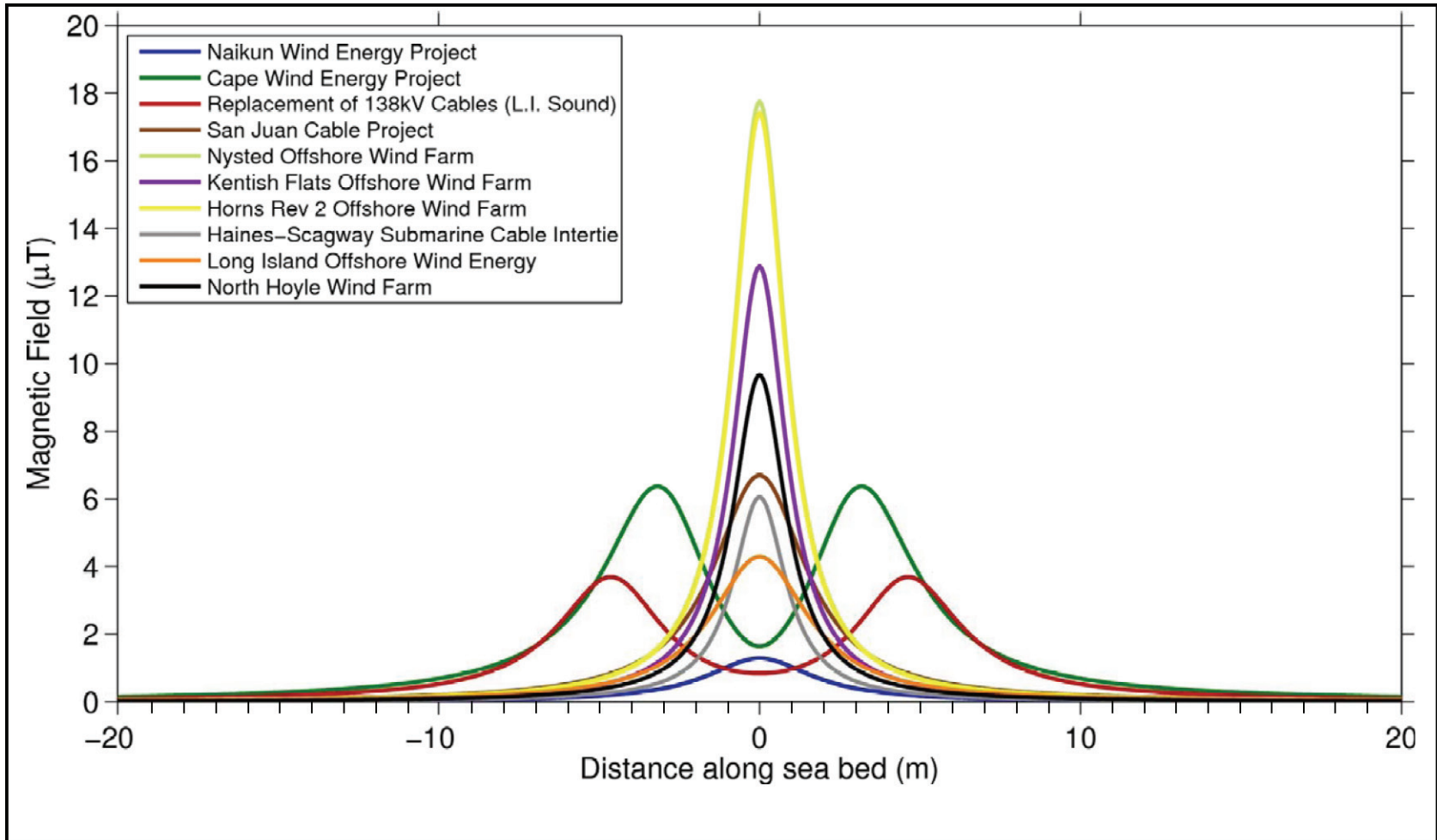

Appendix Figure B-1. AC magnetic field profiles across the surface of the seabed for 10 submarine cable systems. Note that the profiles from Horns Rev 2 Offshore Wind Farm and the Nysted Offshore Wind Farm almost completely overlap each other.

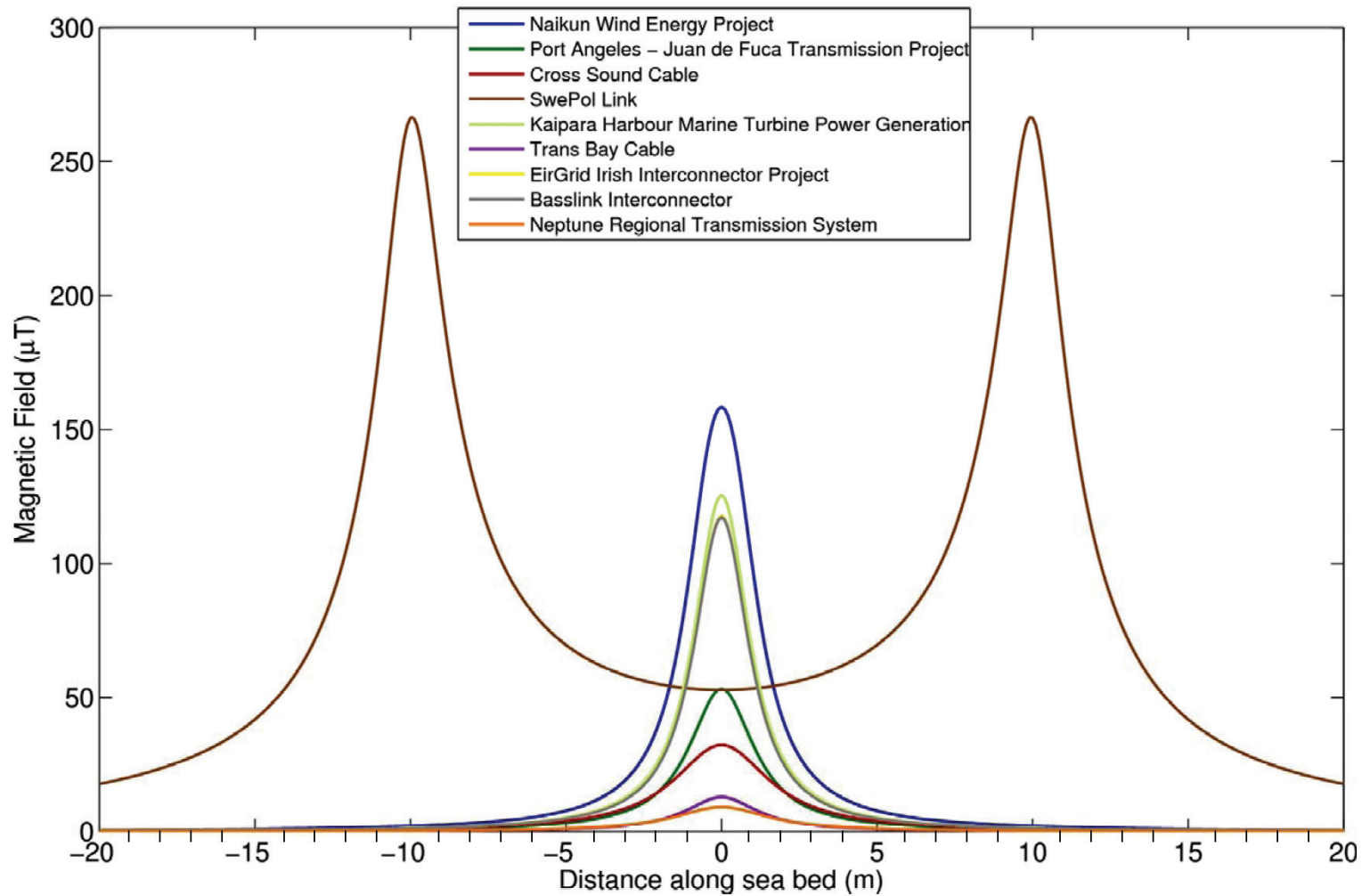

Appendix Figure B-2. DC magnetic field calculated at seabed surface for 9 submarine projects using buried bipolar and monopolar (with cable return) HVDC undersea cables. Note that the profiles for the Basslink Interconnector and the EirGrid Irish Interconnector Project almost completely overlap each other.

Appendix C
Biological Information

Appendix C provides information on documentation of electro- or magnetosensitivity, natural history, geographic range, and distribution by BOEMRE planning areas for:

Elasmobranchs (Appendix Tables C-1 through C-4)

Other fishes (Appendix Tables C-5 through C-7)

Marine mammals (Appendix Tables C-8 through C-10)

Sea Turtles (Appendix Tables C-11 through C-13)

Invertebrates (Appendix Tables C-14 through C-16)

Appendix Table C-1

Worldwide listing of elasmobranch species for which information on sensitivity to electric or magnetic fields has been suggested or studied, along with related species from US waters and any federally listed threatened (T) or endangered (E) species.

Species ^a	Common Name	Status ^b	US ? ^c	Evidence Taxon	Sensitivity ^d	Sensory Range	Evidence Basis	Citation
Class Chondrichthyes, Subclass Elasmobranchii: sharks, skates, and rays								
Order Hexanchiformes, Family Chlamydoselachidae: frill sharks								
<i>Chlamydoselachus anguineus</i>	frill shark		US	Elasmobranchii	E	n/a	n/a	
Order Hexanchiformes, Family Hexanchidae: cow sharks								
<i>Heptranchias perlo</i>	sharpnose sevengill shark		US	Elasmobranchii	E	n/a	n/a	
<i>Hexanchus griseus</i>	bluntnose sixgill shark		US	Elasmobranchii	E	n/a	n/a	
<i>Hexanchus nakamurai</i>	bigeye sixgill shark		US	Elasmobranchii	E	n/a	n/a	
<i>Notorynchus cepedianus</i>	broadnose sevengill shark		US	Elasmobranchii	E	n/a	n/a	
Order Squaliformes, Family Echinorhinidae: bramble sharks								
<i>Echinorhinus brucus</i>	bramble shark		US	Elasmobranchii	E	n/a	n/a	
<i>Echinorhinus cookei</i>	prickly shark		US	Elasmobranchii	E	n/a	n/a	
Order Squaliformes, Family Squalidae: dogfish sharks								
<i>Cirrhigaleus asper</i>	roughskin dogfish		US	Elasmobranchii	E	n/a	n/a	
<i>Squalus acanthias</i>	spiny dogfish, spurdog		US	direct	none	n/a	none: no behavioral response to EMFs from 36kV AC cable	Gill et al. 2009
<i>Squalus acanthias</i>	spiny dogfish, spurdog		US	<i>S. acanthias</i>	E	n/a	none: no behavioral response to EMFs from 36kV AC cable	
<i>Squalus cubensis</i>	Cuban dogfish		US	Elasmobranchii	E	n/a	n/a	
Order Squaliformes, Family Etmopteridae: lantern sharks								
<i>Centroscyllium fabricii</i>	black dogfish		US	Elasmobranchii	E	n/a	n/a	
<i>Etmopterus bigelowi</i>	blurred lantern shark		US	Elasmobranchii	E	n/a	n/a	
<i>Etmopterus gracilispinis</i>	broadband lantern shark		US	Elasmobranchii	E	n/a	n/a	

Appendix Table C-1 Worldwide listing of elasmobranch species for which information on sensitivity to electric or magnetic fields has been suggested or studied, along with related species from US waters and any federally listed threatened (T) or endangered (E) species. (continued)

Species ^a	Common Name	Status ^b	US ? ^c	Evidence Taxon	Sensitivity ^d	Sensory Range	Evidence Basis	Citation
Order Squaliformes, Family Somniosidae: sleeper sharks								
<i>Centroscymnus coelolepis</i>	Portuguese shark		US	Elasmobranchii	E	n/a	n/a	
<i>Somniosus microcephalus</i>	Greenland shark		US	Elasmobranchii	E	n/a	n/a	
<i>Somniosus pacificus</i>	Pacific sleeper shark		US	Elasmobranchii	E	n/a	n/a	
Order Squaliformes, Family Dalatiidae: kitefin sharks								
<i>Dalatias licha</i>	kitefin shark		US	Elasmobranchii	E	n/a	n/a	
Order Squantiformes, Family Squatinidae: angel sharks								
<i>Squatina californica</i>	Pacific angel shark		US	Elasmobranchii	E	n/a	n/a	
<i>Squatina dumeril</i>	Atlantic angel shark		US	Elasmobranchii	E	n/a	n/a	
Order Heterodontiformes, Family Heterodontidae: bullhead sharks								
<i>Heterodontus francisci</i>	horn shark		US	Elasmobranchii	E	n/a	n/a	
Order Orectolobiformes, Family Ginglymostomatidae: nurse sharks								
<i>Ginglymostoma cirratum</i>	nurse shark		US	direct	E	frequency: DC fields and AC fields <1.6 Hz	behavioral	Johnson et al. 1984
<i>Ginglymostoma cirratum</i>	nurse shark		US	<i>Ginglymostoma cirratum</i>	E	frequency: DC fields and AC fields <1.6 Hz	behavioral	
Order Orectolobiformes, Family Rhincodontidae: whale sharks								
<i>Rhincodon typus</i>	whale shark		US	Elasmobranchii	E	n/a	n/a	
Order Lamniformes, Family Mitsukurinidae: goblin sharks								
<i>Mitsukurina owstoni</i>	goblin shark		US	Elasmobranchii	E	n/a	n/a	
Order Lamniformes, Family Odontaspidae: sand tigers								
<i>Carcharias taurus</i>	sand tiger		US	Elasmobranchii	E	n/a	n/a	
<i>Odontaspis ferox</i>	ragged-tooth shark		US	Elasmobranchii	E	n/a	n/a	

Appendix Table C-1 Worldwide listing of elasmobranch species for which information on sensitivity to electric or magnetic fields has been suggested or studied, along with related species from US waters and any federally listed threatened (T) or endangered (E) species. (continued)

Species ^a	Common Name	Status ^b	US ? ^c	Evidence Taxon	Sensitivity ^d	Sensory Range	Evidence Basis	Citation
<i>Odontaspis noronhai</i>	bigeye sand tiger		US	Elasmobranchii	E	n/a	n/a	
Order Lamniformes, Family Megachasmidae: megamouth sharks								
<i>Megachasma pelagios</i>	megamouth shark		US	Elasmobranchii	E	n/a	n/a	
Order Lamniformes, Family Alopiidae: thresher sharks								
<i>Alopias superciliosus</i>	bigeye thresher		US	Elasmobranchii	E	n/a	n/a	
<i>Alopias vulpinus</i>	thresher shark		US	Elasmobranchii	E	n/a	n/a	
Order Lamniformes, Family Cetorhinidae: basking sharks								
<i>Cetorhinus maximus</i>	basking shark		US	Elasmobranchii	E	n/a	n/a	
Order Lamniformes, Family Lamnidae: mackerel sharks								
<i>Carcharodon carcharias</i>	white shark		US	direct	M?	geomagnetic field	behavioral/ observational: swim patterns	Klimley et al. 2002
<i>Carcharodon carcharias</i>	white shark		US	direct	M?	geomagnetic field	anatomical/ theoretical: orientation of ampullary receptors	Tricas 2001
<i>Carcharodon carcharias</i>	white shark		US	direct	E	pulsed DC field preferred over static DC field	behavioral/ observational: prey preference	Tricas and McCosker 1984
<i>Carcharodon carcharias</i>	white shark		US	<i>C. carcharias</i>	E/M?	geomagnetic field/electric field sensitivity n/a	behavioral/ observational/ anatomical/ theoretical	
<i>Isurus oxyrinchus</i>	shortfin mako		US	direct	M?	geomagnetic field	behavioral/ observational: swim patterns	Klimley et al. 2002
<i>Isurus oxyrinchus</i>	shortfin mako		US	<i>I. oxyrinchus</i>	E/M?	geomagnetic field/electric field sensitivity n/a	behavioral/ observational	
<i>Isurus paucus</i>	longfin mako		US	<i>C. carcharias, I. oxyrinchus</i>	E	n/a	n/a	

Appendix Table C-1 Worldwide listing of elasmobranch species for which information on sensitivity to electric or magnetic fields has been suggested or studied, along with related species from US waters and any federally listed threatened (T) or endangered (E) species. (continued)

Species ^a	Common Name	Status ^b	US ? ^c	Evidence Taxon	Sensitivity ^d	Sensory Range	Evidence Basis	Citation
Order Carcharhiniformes, Family Scyliorhinidae: cat sharks								
<i>Lamna ditropis</i>	salmon shark		US	<i>C. carcharias, I. oxyrinchus</i>	E	n/a	n/a	
<i>Lamna nasus</i>	porbeagle		US	<i>C. carcharias, I. oxyrinchus</i>	E	n/a	n/a	
<i>Apristurus brunneus</i>	brown cat shark		US	<i>S. canicula</i>	E	n/a	n/a	
<i>Cephaloscyllium isabellum</i>	carpet shark		No	direct	E	2 μ V/cm at 2 Hz	physiological: neural response	Bodznick and Montgomery 1992
<i>Cephaloscyllium isabellum</i>	carpet shark		No	direct	E	0.2-10V and 0.1-5A, DC	behavioral: orientation, weak response	Yano et al. 2000
<i>Cephaloscyllium isabellum</i>	carpet shark		No	<i>C. isabellum</i>	E	2 μ V/cm	physiological/ behavioral	
<i>Cephaloscyllium ventriosum</i>	swell shark		US	direct	E	n/a	behavioral: feeding response	Tricas 1982
<i>Cephaloscyllium ventriosum</i>	swell shark		US	<i>C. ventriosum</i>	E	n/a	behavioral	
<i>Galeus arae</i>	marbled cat shark		US	<i>S. canicula</i>	E	n/a	n/a	
<i>Parmaturus xaniurus</i>	filetail cat shark		US	<i>S. canicula</i>	E	n/a	n/a	
<i>Scyliorhinus canicula</i>	small-spotted cat shark		No	direct	E	applied current 15 μ A with electrodes <30mm below bottom substrate	behavioral: feeding response	Filer et al. 2008
<i>Scyliorhinus canicula</i>	small-spotted cat shark		No	direct	E	0.1 μ V/cm, 10cm from source	behavioral: feeding response	Gill and Taylor 2001
<i>Scyliorhinus canicula</i>	small-spotted cat shark		No	direct	E/M	EMFs from 36kV AC cable	behavioral: attraction/ decreased movement	Gill et al. 2009
<i>Scyliorhinus canicula</i>	small-spotted cat shark		No	direct	E	0.01 mV/cm, 5 Hz	physiological: heart rate response	Kalmijn 1966

Appendix Table C-1 Worldwide listing of elasmobranch species for which information on sensitivity to electric or magnetic fields has been suggested or studied, along with related species from US waters and any federally listed threatened (T) or endangered (E) species. (continued)

Species ^a	Common Name	Status ^b	US ? ^c	Evidence Taxon	Sensitivity ^d	Sensory Range	Evidence Basis	Citation
<i>Scyliorhinus canicula</i>	small-spotted cat shark		No	direct	E	0.01 μ V/cm	behavioral: feeding response	Kalmijn 1971
<i>Scyliorhinus canicula</i>	small-spotted cat shark		No	direct	E	0.95 μ V/cm	behavioral: feeding response	Kimber et al. 2009
<i>Scyliorhinus canicula</i>	small-spotted cat shark		No	direct	E	50 mV/m	behavioral: feeding response	Pals et al. 1982a
<i>Scyliorhinus canicula</i>	small-spotted cat shark		No	direct	E	40 nV/cm, 0.1 to 5 Hz	physiological: neural response/ respiratory reflex	Peters and Evers 1985
<i>Scyliorhinus canicula</i>	small-spotted cat shark		No	direct	E	0.01 to 0.1 μ V/cm	behavioral/ physiological	
<i>Scyliorhinus retifer</i>	chain dogfish		US		E	n/a	n/a	
<i>Scyliorhinus torazame</i>	cloudy catshark		No	direct	E	0.2-10V and 0.1-5A, DC	behavioral: orientation, weak response	Yano et al. 2000
<i>Scyliorhinus torazame</i>	cloudy catshark		No	direct	E	0.2-10V and 0.1-5A, DC	behavioral	
Order Carcharhiniformes, Family Pseudotriakidae: false cat sharks								
<i>Pseudotriakis microdon</i>	false cat shark		US	Elasmobranchii	E	n/a	n/a	
Order Carcharhiniformes, Family Triakidae: hound sharks								
<i>Galeorhinus galeus</i>	tope		US	<i>M. canis</i>	E	n/a	n/a	
<i>Mustelus californicus</i>	gray smoothhound		US	<i>M. canis</i>	E	n/a	n/a	
<i>Mustelus canis</i>	smooth dogfish		US	direct	E	juveniles: 0.02 to 0.04 μ V/cm minimum threshold; adults: 0.005 to 0.01 μ V/cm minimum threshold	behavioral: feeding response	Dawson et al. 1980
<i>Mustelus canis</i>	smooth dogfish		US	direct	E	5 nV/cm	behavioral: feeding response	Kalmijn 1982
<i>Mustelus canis</i>	smooth dogfish		US	<i>M. canis</i>	E	0.005 to 0.01 μ V/cm minimum threshold	behavioral	

Appendix Table C-1 Worldwide listing of elasmobranch species for which information on sensitivity to electric or magnetic fields has been suggested or studied, along with related species from US waters and any federally listed threatened (T) or endangered (E) species. (continued)

Species ^a	Common Name	Status ^b	US ? ^c	Evidence Taxon	Sensitivity ^d	Sensory Range	Evidence Basis	Citation
<i>Mustelus henlei</i>	brown smoothhound		US	<i>M. canis</i>	E	n/a	n/a	
<i>Mustelus lunulatus</i>	sicklefin smoothhound		US	<i>M. canis</i>	E	n/a	n/a	
<i>Mustelus norrisi</i>	Florida smoothhound		US	<i>M. canis</i>	E	n/a	n/a	
<i>Mustelus sinuamexicanus</i>	Gulf smoothhound		US	<i>M. canis</i>	E	n/a	n/a	
<i>Triakis semifasciata</i>	leopard shark		US	direct	E	mean, maximum threshold of 9.64 ± 10.28 V/m	behavioral: retreat response	Marcotte and Lowe 2008
<i>Triakis semifasciata</i>	leopard shark		US	<i>T. semifasciata</i>	E	mean, maximum threshold of 9.64 ± 10.28 V/m	behavioral	
<i>Triakis scyllium</i>	banded houndshark		No	direct	E	0.2-10V and 0.1-5A, DC	behavioral: orientation, strong response	Yano et al. 2000
<i>Triakis scyllium</i>	banded houndshark		No	direct	E	0.2-10V and 0.1-5A, DC	behavioral	
Order Carcharhiniformes, Family Carcharhinidae: requiem sharks								
<i>Carcharhinus acronotus</i>	blacknose shark		US	<i>C. plumbeus</i>	E	n/a	n/a	
<i>Carcharhinus altimus</i>	bignose shark		US	<i>C. plumbeus</i>	E	n/a	n/a	
<i>Carcharhinus brachyurus</i>	narrowtooth shark		US	<i>C. plumbeus</i>	E	n/a	n/a	
<i>Carcharhinus brevipinna</i>	spinner shark		US	<i>C. plumbeus</i>	E	n/a	n/a	
<i>Carcharhinus falciformis</i>	silky shark		US	direct	E	0.2-10V and 0.1-5A, DC	behavioral: orientation, strong response	Yano et al. 2000
<i>Carcharhinus falciformis</i>	silky shark		US	<i>C. falciformis</i>	E	0.2-10V and 0.1-5A, DC	behavioral	

Appendix Table C-1 Worldwide listing of elasmobranch species for which information on sensitivity to electric or magnetic fields has been suggested or studied, along with related species from US waters and any federally listed threatened (T) or endangered (E) species. (continued)

Species ^a	Common Name	Status ^b	US ? ^c	Evidence Taxon	Sensitivity ^d	Sensory Range	Evidence Basis	Citation
<i>Carcharhinus galapagensis</i>	Galapagos shark		US	<i>C. plumbeus</i>	E	n/a	n/a	
<i>Carcharhinus isodon</i>	finetooth shark		US	<i>C. plumbeus</i>	E	n/a	n/a	
<i>Carcharhinus leucas</i>	bull shark		US	direct	E	n/a	review of passive electroreception with bull shark case study	Collin and Whitehead 2004
<i>Carcharhinus leucas</i>	bull shark		US	direct	E	current <10 μ A	behavioral: orientation	Whitehead 2002
<i>Carcharhinus leucas</i>	bull shark		US	<i>C. leucas</i>	E	current <10 μ A	behavioral	
<i>Carcharhinus limbatus</i>	blacktip shark		US	<i>C. plumbeus</i>	E	n/a	n/a	
<i>Carcharhinus longimanus</i>	oceanic whitetip shark		US	<i>C. plumbeus</i>	E	n/a	n/a	
<i>Carcharhinus melanopterus</i>	blacktip reef shark		No	direct	E	n/a	theoretical: modeling effective distance for prey detection	Haine et al. 2001
<i>Carcharhinus melanopterus</i>	blacktip reef shark		No	direct	E	0.2-10V and 0.1-5A, DC	behavioral: orientation, strong response	Yano et al. 2000
<i>Carcharhinus melanopterus</i>	blacktip reef shark		No	<i>C. melanopterus</i>	E	0.2-10V and 0.1-5A, DC	behavioral	
<i>Carcharhinus obscurus</i>	dusky shark		US	<i>C. plumbeus</i>	E	n/a	n/a	
<i>Carcharhinus perezii</i>	reef shark		US	<i>C. plumbeus</i>	E	n/a	n/a	
<i>Carcharhinus plumbeus</i>	sandbar shark		US	direct	E	within 100 cm of electropositive metal bars	behavioral: avoidance	Brill et al. 2009
<i>Carcharhinus plumbeus</i>	sandbar shark		US	direct	E	n/a	anatomical/ theoretical: ampullary pore distribution	Kajiura 2001b
<i>Carcharhinus plumbeus</i>	sandbar shark		US	direct	E	median: 0.0303 μ V/cm	behavioral: feeding response	Kajiura and Holland 2002
<i>Carcharhinus plumbeus</i>	sandbar shark		US	direct	M	25-100 μ T	behavioral: conditioned response	Meyer et al. 2005

Appendix Table C-1 Worldwide listing of elasmobranch species for which information on sensitivity to electric or magnetic fields has been suggested or studied, along with related species from US waters and any federally listed threatened (T) or endangered (E) species. (continued)

Species ^a	Common Name	Status ^b	US ? ^c	Evidence Taxon	Sensitivity ^d	Sensory Range	Evidence Basis	Citation
<i>Carcharhinus plumbeus</i>	sandbar shark		US	<i>C. plumbeus</i>	E/M	median: 0.0303 μ V/cm; 25-100 μ T	behavioral/ anatomical/ theoretical	
<i>Carcharhinus porosus</i>	smalltail shark		US	<i>C. plumbeus</i>	E	n/a	n/a	
<i>Carcharhinus signatus</i>	night shark		US	<i>C. plumbeus</i>	E	n/a	n/a	
<i>Galeocerdo cuvier</i>	tiger shark		US	direct	none	n/a	none: no behavioral response to 0.2-10V and 0.1-5A, DC	Yano et al. 2000
<i>Galeocerdo cuvier</i>	tiger shark		US	<i>G. cuvier</i>	none	n/a	none: no behavioral response to 0.2-10V and 0.1-5A, DC	
<i>Negaprion brevirostris</i>	lemon shark		US	<i>C. plumbeus</i>	E	n/a	n/a	
<i>Prionace glauca</i>	blue shark		US	direct	E	5 nV/cm	behavioral: feeding response	Heyer et al. 1981
<i>Prionace glauca</i>	blue shark		US	direct	E	5 nV/cm	behavioral: feeding response	Kalmijn 1982
<i>Prionace glauca</i>	blue shark		US	direct	M?	geomagnetic field	behavioral/ observational: swim patterns	Klimley et al. 2002
<i>Prionace glauca</i>	blue shark		US	<i>P. glauca</i>	E/M?	5 nV/cm; geomagnetic field	behavioral/ observational	
<i>Rhizoprionodon longurio</i>	Pacific sharpnose shark		US	<i>C. plumbeus</i>	E	n/a	n/a	
<i>Rhizoprionodon terraenovae</i>	Atlantic sharpnose shark		US	<i>C. plumbeus</i>	E	n/a	n/a	
<i>Triaenodon obesus</i>	whitetip reef shark		No	direct	E	0.2-10V and 0.1-5A, DC	behavioral: orientation, strong response	Yano et al. 2000
<i>Triaenodon obesus</i>	whitetip reef shark		No	<i>T. obesus</i>	E	0.2-10V and 0.1-5A, DC	behavioral	
Order Carcharhiniformes, Family Sphyrnidae: hammerhead sharks								
<i>Sphyrna lewini</i>	scalloped hammerhead		US	direct	E	n/a	anatomical/theoretical: ampullary pore distribution	Kajiura 2001b

Appendix Table C-1 Worldwide listing of elasmobranch species for which information on sensitivity to electric or magnetic fields has been suggested or studied, along with related species from US waters and any federally listed threatened (T) or endangered (E) species. (continued)

Species ^a	Common Name	Status ^b	US ? ^c	Evidence Taxon	Sensitivity ^d	Sensory Range	Evidence Basis	Citation
<i>Sphyrna lewini</i>	scalloped hammerhead		US	direct	E	10 nV/cm	behavioral: feeding response	Kajiura and Fitzgerald 2009
<i>Sphyrna lewini</i>	scalloped hammerhead		US	direct	E	median: 0.0252 μ V/cm	behavioral: feeding response	Kajiura and Holland 2002
<i>Sphyrna lewini</i>	scalloped hammerhead		US	direct	M?	geomagnetic field	behavioral/ observational: swim patterns	Klimley 1993
<i>Sphyrna lewini</i>	scalloped hammerhead		US	direct	E	mean, maximum threshold of 18.50 \pm 13.27 V/m	behavioral: retreat response	Marcotte and Lowe 2008
<i>Sphyrna lewini</i>	scalloped hammerhead		US	direct	M	25-100 μ T	behavioral: conditioned response	Meyer et al. 2005
<i>Sphyrna lewini</i>	scalloped hammerhead		US	<i>S. lewini</i>	E/M	0.01 μ V/cm; 25-100 μ T	behavioral/ observational/ anatomical/ theoretical	
<i>Sphyrna mokarran</i>	great hammerhead		US	<i>S. lewini</i>	E	n/a	n/a	
<i>Sphyrna tiburo</i>	bonnethead		US	direct	E	n/a	anatomical/ theoretical: ampullary pore distribution	Kajiura 2001b
<i>Sphyrna tiburo</i>	bonnethead		US	direct	E	min: < 1 nV/cm; median: 47 nV/cm	behavioral: feeding response	Kajiura 2003
<i>Sphyrna tiburo</i>	bonnethead		US	<i>S. tiburo</i>	E	min: < 1 nV/cm; median: 47 nV/cm	behavioral/ anatomical/ theoretical	
<i>Sphyrna zygaena</i>	smooth hammerhead		US	<i>S. lewini</i>	E	n/a	n/a	
Order Torpediniformes, Family Narcinidae: electric rays								
<i>Narcine bancroftii</i>	lesser electric ray		US	Elasmobranchii	E	n/a	n/a	
Order Torpediniformes, Family Torpedinidae: torpedo electric rays								
<i>Torpedo californica</i>	Pacific electric ray		US	direct	E	n/a	behavioral: feeding response	Lowe et al. 1994

Appendix Table C-1 Worldwide listing of elasmobranch species for which information on sensitivity to electric or magnetic fields has been suggested or studied, along with related species from US waters and any federally listed threatened (T) or endangered (E) species. (continued)

Species ^a	Common Name	Status ^b	US ? ^c	Evidence Taxon	Sensitivity ^d	Sensory Range	Evidence Basis	Citation
<i>Torpedo californica</i>	Pacific electric ray		US	<i>T. californica</i>	E	n/a	behavioral	
<i>Torpedo nobiliana</i>	Atlantic torpedo		US	<i>T. californica</i>	E	n/a	n/a	
Order Pristiformes, Family Pristidae: sawfishes								
<i>Pristis pectinata</i>	smalltooth sawfish	E	US	Elasmobranchii	E	n/a	n/a	
<i>Pristis pristis</i>	largetooth sawfish		US	Elasmobranchii	E	n/a	n/a	
Order Rajiformes, Family Rhinobatidae: guitarfishes								
<i>Rhinobatos lentiginosus</i>	Atlantic guitarfish		US	Elasmobranchii	E	n/a	n/a	
<i>Rhinobatos productus</i>	shovelnose guitarfish		US	Elasmobranchii	E	n/a	n/a	
<i>Zapteryx exasperata</i>	banded guitarfish		US	Elasmobranchii	E	n/a	n/a	
Order Rajiformes, Family Platyrhynidae: thornbacks								
<i>Platyrhinoidis triseriata</i>	thornback		US	direct	E	n/a	physiological: neural response	Bullock et al. 1993
<i>Platyrhinoidis triseriata</i>	thornback		US	<i>P. triseriata</i>	E	n/a	physiological	
Order Rajiformes, Family Rajidae: skates								
<i>Amblyraja radiata</i>	thorny skate		US	direct	E	n/a	anatomical/ theoretical: ampullary pore size and distribution	Raschi and Adams 1988
<i>Amblyraja radiata</i>	thorny skate		US	<i>A. radiata</i>	E	n/a	anatomical/ theoretical	
<i>Bathyraja aleutica</i>	Aleutian skate		US	<i>L. erinacea</i>	E	n/a	n/a	
<i>Bathyraja interrupta</i>	sandpaper skate		US	<i>L. erinacea</i>	E	n/a	n/a	
<i>Bathyraja lindbergi</i>	Commander skate		US	<i>L. erinacea</i>	E	n/a	n/a	

Appendix Table C-1 Worldwide listing of elasmobranch species for which information on sensitivity to electric or magnetic fields has been suggested or studied, along with related species from US waters and any federally listed threatened (T) or endangered (E) species. (continued)

Species ^a	Common Name	Status ^b	US ? ^c	Evidence Taxon	Sensitivity ^d	Sensory Range	Evidence Basis	Citation
<i>Bathyraja maculata</i>	whiteblotched skate		US	<i>L. erinacea</i>	E	n/a	n/a	
<i>Bathyraja parmifera</i>	Alaska skate		US	<i>L. erinacea</i>	E	n/a	n/a	
<i>Bathyraja spinicauda</i>	spinytail skate		US	<i>L. erinacea</i>	E	n/a	n/a	
<i>Bathyraja taranetzi</i>	mud skate		US	<i>L. erinacea</i>	E	n/a	n/a	
<i>Bathyraja violacea</i>	Okhotsk skate		US	<i>L. erinacea</i>	E	n/a	n/a	
<i>Dipturus bullisi</i>	lozenge skate		US	<i>L. erinacea</i>	E	n/a	n/a	
<i>Dipturus laevis</i>	barndoor skate		US	direct	E	n/a	anatomical/ theoretical: modeling	Camperi et al. 2007
<i>Dipturus laevis</i>	barndoor skate		US	direct	M?	geomagnetic field	anatomical/theoretical: orientation of ampullary receptors	Tricas 2001
<i>Dipturus laevis</i>	barndoor skate		US	<i>D. laevis</i>	E/M?	n/a ; geomagnetic field	anatomical/ theoretical	
<i>Dipturus olseni</i>	spreadfin skate		US	<i>L. erinacea</i>	E	n/a	n/a	
<i>Leucoraja erinacea</i>	little skate		US	direct	E	2 μ V/cm at 2 Hz	physiological: neural response	Bodznick et al. 1992
<i>Leucoraja erinacea</i>	little skate		US	direct	E	n/a	electric discharge in response to electric stimulation (0.2 Hz sinusoidal)	Bratton and Ayers 1987
<i>Leucoraja erinacea</i>	little skate		US	direct	E	n/a	theoretical	Duman and Bodznick 1996
<i>Leucoraja erinacea</i>	little skate		US	direct	E	n/a	anatomical/ physiological	Fields et al. 2007
<i>Leucoraja erinacea</i>	little skate		US	direct	E	1-20 μ V/cm	physiological: neural response	Hjelmstad et al. 1996
<i>Leucoraja erinacea</i>	little skate		US	direct	E	n/a	physiological: neural response	Lu and Fishman 1994

Appendix Table C-1 Worldwide listing of elasmobranch species for which information on sensitivity to electric or magnetic fields has been suggested or studied, along with related species from US waters and any federally listed threatened (T) or endangered (E) species. (continued)

Species ^a	Common Name	Status ^b	US ? ^c	Evidence Taxon	Sensitivity ^d	Sensory Range	Evidence Basis	Citation
<i>Leucoraja erinacea</i>	little skate		US	direct	E	2 μ V/cm, sinusoidal 2 Hz	physiological: neural response	Montgomery and Bodznick 1993
<i>Leucoraja erinacea</i>	little skate		US	direct	E	peak sensitivity at a frequency of 5-10 Hz	physiological: neural response	New 1990
<i>Leucoraja erinacea</i>	little skate		US	direct	E	n/a	physiological/behavioral: electric organ discharge (communication role?)	New 1994
<i>Leucoraja erinacea</i>	little skate		US	direct	E	<5 μ V	physiological: neural response	Salyapongse et al. 1992
<i>Leucoraja erinacea</i>	little skate		US	<i>L. erinacea</i>	E	1-20 μ V/cm	physiological/ behavioral/ anatomical	
<i>Leucoraja garmani</i>	rosette skate		US	<i>L. erinacea</i>	E	n/a	n/a	
<i>Leucoraja lentiginosa</i>	freckled skate		US	<i>L. erinacea</i>	E	n/a	n/a	
<i>Leucoraja ocellata</i>	winter skate		US	direct	E	n/a	electric discharge in response to electric stimulation (0.2 Hz sinusoidal)	Bratton and Ayers 1987
<i>Leucoraja ocellata</i>	winter skate		US	direct	E	n/a	physiological: neural response	Lu and Fishman 1994
<i>Leucoraja ocellata</i>	winter skate		US	direct	E	n/a	physiological/behavioral: electric organ discharge (communication role?)	New 1994
<i>Leucoraja ocellata</i>	winter skate		US	<i>L. ocellata</i>	E	n/a	physiological/ behavioral	
<i>Leucoraja virginica</i>	Virginia skate		US	<i>L. erinacea</i>	E	n/a	n/a	
<i>Malacoraja senta</i>	smooth skate		US	<i>L. erinacea</i>	E	n/a	n/a	
<i>Raja ackleyi</i>	ocellate skate		US	<i>L. erinacea</i>	E	n/a	n/a	
<i>Raja binoculata</i>	big skate		US	<i>L. erinacea</i>	E	n/a	n/a	
<i>Raja clavata</i>	thornback ray		No	direct	E	voltage: 1-3 mV	physiological: neural response	Broun et al. 1979

Appendix Table C-1 Worldwide listing of elasmobranch species for which information on sensitivity to electric or magnetic fields has been suggested or studied, along with related species from US waters and any federally listed threatened (T) or endangered (E) species. (continued)

Species ^a	Common Name	Status ^b	US ? ^c	Evidence Taxon	Sensitivity ^d	Sensory Range	Evidence Basis	Citation
<i>Raja clavata</i>	thornback ray		No	direct	E/M	0.35 G; induced field = 0.16 mV/cm	physiological: neural response	Brown and Ilyinsky 1978
<i>Raja clavata</i>	thornback ray		No	direct	E/M	EMFs from 36kV AC cable	behavioral: increased movement in some individuals	Gill et al. 2009
<i>Raja clavata</i>	thornback ray		No	direct	E	0.01 mV/cm, 5 Hz	physiological: heart rate response	Kalmijn 1966
<i>Raja clavata</i>	thornback ray		No	direct	E	0.01 μV/cm	behavioral: feeding response	Kalmijn 1971
<i>Raja clavata</i>	thornback ray		No	direct	E	maximum response at a frequency of 4 Hz	physiological: neural response	Montgomery 1984
<i>Raja clavata</i>	thornback ray		No	<i>R. clavata</i>	E/M	0.01 μV/cm; 0.35 G: induced field = 0.16 mV/cm	behavioral/ physiological	
<i>Raja eglantheria</i>	clearnose skate		US	direct	E	frequency of 0.5 and 7 Hz, varied by developmental stage	behavioral/physiological: neural response	Sisneros et al. 1998
<i>Raja eglantheria</i>	clearnose skate		US	<i>R. eglantheria</i>	E	frequency of 0.5 and 7 Hz, varied by developmental stage	behavioral/ physiological	
<i>Raja inornata</i>	California skate		US	<i>L. erinacea</i>	E	n/a	n/a	
<i>Raja rhina</i>	longnose skate		US	<i>L. erinacea</i>	E	n/a	n/a	
<i>Raja stellulata</i>	starry skate		US	<i>L. erinacea</i>	E	n/a	n/a	
<i>Raja texana</i>	roundel skate		US	<i>L. erinacea</i>	E	n/a	n/a	
Order Myliobatiformes, Family Dasyatidae: whiptail stingrays								
<i>Dasyatis americana</i>	southern stingray		US	<i>D. sabina</i>	E	n/a	n/a	
<i>Dasyatis centroura</i>	rougtail stingray		US	<i>D. sabina</i>	E	n/a	n/a	

Appendix Table C-1 Worldwide listing of elasmobranch species for which information on sensitivity to electric or magnetic fields has been suggested or studied, along with related species from US waters and any federally listed threatened (T) or endangered (E) species. (continued)

Species ^a	Common Name	Status ^b	US ? ^c	Evidence Taxon	Sensitivity ^d	Sensory Range	Evidence Basis	Citation
<i>Dasyatis dipterura</i>	diamond stingray		US	<i>D. sabina</i>	E	n/a	n/a	
<i>Dasyatis sabina</i>	Atlantic stingray		US	direct	E	7.5 nV/cm	anatomical/physiological: ampullary pore distribution and response to electric field	Bedore and Kajiura 2009
<i>Dasyatis sabina</i>	Atlantic stingray		US	direct	E	n/a	prey detection	Blonder 1985
<i>Dasyatis sabina</i>	Atlantic stingray		US	direct	E	6-14 mV/cm	behavioral: feeding response	Blonder and Alevizon 1988
<i>Dasyatis sabina</i>	Atlantic stingray		US	direct	E	median 6nV/cm	behavioral: orientation	McGowan and Kajiura 2009
<i>Dasyatis sabina</i>	Atlantic stingray		US	direct	E	frequency of 0.01-4 Hz	physiological: neural response	Sisneros and Tricas 2000
<i>Dasyatis sabina</i>	Atlantic stingray		US	direct	E	0.03 to 9.2 μ V/cm (peak frequency sensitivity: 3-4 Hz for neonates, 4-6 Hz for juveniles, and 6-8 Hz for adults)	physiological: neural response	Sisneros and Tricas 2002
<i>Dasyatis sabina</i>	Atlantic stingray		US	<i>D. sabina</i>	E	0.0075 to 9.2 μ V/cm; frequency 0.1 to 8 Hz	behavioral/ anatomical/ physiological	
<i>Dasyatis say</i>	bluntnose stingray		US	<i>D. sabina</i>	E	n/a	n/a	
<i>Himantura granulata</i>	mangrove whipray		No	direct	E	n/a	theoretical: modeling effective distance for prey detection	Haine et al. 2001
<i>Himantura granulata</i>	mangrove whipray		No	<i>H. granulata</i>	E	n/a	theoretical	

Appendix Table C-1 Worldwide listing of elasmobranch species for which information on sensitivity to electric or magnetic fields has been suggested or studied, along with related species from US waters and any federally listed threatened (T) or endangered (E) species. (continued)

Species ^a	Common Name	Status ^b	US ? ^c	Evidence Taxon	Sensitivity ^d	Sensory Range	Evidence Basis	Citation
<i>Pteroplatytrygon violacea</i>	pelagic stingray		US	<i>D. sabina</i>	E	n/a	n/a	
Order Myliobatiformes, Family Urolophidae: round stingrays								
<i>Urobatis halleri</i>	round stingray		US	direct	E	n/a	physiological: neural response	Bullock et al. 1993
<i>Urobatis halleri</i>	round stingray		US	direct	M	5 nV/cm	behavioral: orientation	Kalmijn 1982
<i>Urobatis halleri</i>	round stingray		US	direct	E	40 nV/cm to several μ V/cm	physiological: neural response	Tricas and New 1998
<i>Urobatis halleri</i>	round stingray		US	direct	E	peak current 8 μ A	behavioral: attraction, detection of conspecifics	Tricas et al. 1995
<i>Urobatis halleri</i>	round stingray		US	<i>U. halleri</i>	E/M	0.005 to several μ V/cm	behavioral/ physiological	
<i>Urobatis jamaicensis</i>	yellow stingray		US	<i>U. halleri</i>	E	n/a	n/a	
Order Myliobatiformes, Family Gymnuridae: butterfly rays								
<i>Gymnura altavela</i>	spiny butterfly ray		US	Elasmobranchii	E	n/a	n/a	
<i>Gymnura marmorata</i>	California butterfly ray		US	Elasmobranchii	E	n/a	n/a	
<i>Gymnura micrura</i>	smooth butterfly ray		US	Elasmobranchii	E	n/a	n/a	
Order Myliobatiformes, Family Myliobatidae: eagle rays								
<i>Aetobatus narinari</i>	spotted eagle ray		US	<i>M. californica</i>	E	n/a	n/a	
<i>Myliobatis californica</i>	bat ray		US	direct	M?	geomagnetic field	theoretical/ observational: swim patterns	Klimley et al. 2005
<i>Myliobatis californica</i>	bat ray		US	<i>M. californica</i>	M?	geomagnetic field	theoretical/ observational	
<i>Myliobatis freminvillei</i>	bullnose ray		US	<i>M. californica</i>	E	n/a	n/a	
<i>Myliobatis goodei</i>	southern eagle ray		US	<i>M. californica</i>	E	n/a	n/a	

Appendix Table C-1 Worldwide listing of elasmobranch species for which information on sensitivity to electric or magnetic fields has been suggested or studied, along with related species from US waters and any federally listed threatened (T) or endangered (E) species. (continued)

Species ^a	Common Name	Status ^b	US ? ^c	Evidence Taxon	Sensitivity ^d	Sensory Range	Evidence Basis	Citation
Order Myliobatiformes, Family Rhinopteridae: cownose rays								
<i>Rhinoptera bonasus</i>	cownose ray		US	direct	E	7.5 nV/cm	anatomical/physiological: ampullary pore distribution and response to electric field	Bedore and Kajiura 2009
<i>Rhinoptera bonasus</i>	cownose ray		US	<i>R. bonasus</i>	E	7.5 nV/cm	anatomical/ physiological	
Order Myliobatiformes, Family Mobulidae: mantas								
<i>Manta birostris</i>	giant manta		US	Elasmobranchii	E	n/a	n/a	
<i>Mobula hypostoma</i>	devil ray		US	Elasmobranchii	E	n/a	n/a	
<i>Mobula japanica</i>	spinetail mobula		US	Elasmobranchii	E	n/a	n/a	
<i>Mobula tarapacana</i>	sicklefin devil ray		US	Elasmobranchii	E	n/a	n/a	

^a Species listed alphabetically within Family. ^bStatus: federal threatened (T) or endangered (E) status; ^cUS?: US=species occurs in US waters, Not in US=species does not occur in US waters; ^dSensitivity: sensitivity findings, M=magnetosensitivity, E=electrosensitivity, none=species studied with no sensitivity reported. Shaded rows summarize findings for US species.

Appendix Table C-2

Natural history characteristics of elasmobranch species in US waters.

Species	Common Name	Status ^a	EFH ^b	Habitat	Depth (m)	Movement	Seasonal Occurrence	Lifestage Occurrence	Citation
Class Chondrichthyes, Subclass Elasmobranchii: sharks, skates, and rays									
Order Hexanchiformes, Family Chlamydoselachidae: frill sharks									
<i>Chlamydoselachus anguineus</i>	frill shark			benthic/ OCS	120 to 1280				Compagno 1984
Order Hexanchiformes, Family Hexanchidae: cow sharks									
<i>Heptranchias perlo</i>	sharpnose sevengill shark		S	marine/ benthic	27 to 720				Compagno 1984
<i>Hexanchus griseus</i>	bluntnose sixgill shark		S	marine/ benthic/ pelagic	0 to 1875				Compagno 1984
<i>Hexanchus nakamurai</i>	bigeye sixgill shark		S	on/near bottom, continental and insular shelves	90 to 600				Compagno 1984
<i>Notorynchus cepedianus</i>	broadnose sevengill shark			marine/ benthic/ neritic	<46				Compagno 1984
Order Squaliformes, Family Echinorhinidae: bramble sharks									
<i>Echinorhinus brucus</i>	bramble shark			benthic, shallow-deep cont. shelf, coastal	18 to 900				Compagno 1984
<i>Echinorhinus cookei</i>	prickly shark			benthic, cont. shelf	11 to 424				Compagno 1984
Order Squaliformes, Family Squalidae: dogfish sharks									
<i>Cirrhigaleus asper</i>	roughskin dogfish			upper cont. shelf on/ near bottom	200 to 650				Compagno 1984
<i>Squalus acanthias</i>	spiny dogfish, spurdog		P, NE/MA	surface to bottom, usually near bottom, inshore/ offshore cont. shelf	<900				Compagno 1984
<i>Squalus cubensis</i>	Cuban dogfish			on/near bottom, offshore OCS	60 to 380				Compagno 1984
Order Squaliformes, Family Etmopteridae: lantern sharks									
<i>Centroscyllium fabricii</i>	black dogfish			near surface to bottom, outermost cont. shelf	180 to 1600				Compagno 1984

Appendix Table C-2 Natural history characteristics of elasmobranch species in US waters. (continued)

Species	Common Name	Status ^a	EFH ^b	Habitat	Depth (m)	Movement	Seasonal Occurrence	Lifestage Occurrence	Citation
<i>Etmopterus bigelowi</i>	blurred lantern shark			benthopelagic, marine, deep water	163 to 1000				Compagno 1984
<i>Etmopterus gracilispinis</i>	broadband lantern shark			epipelagic / mesopelagic/ OCS	70 to 480;				Compagno 1984
Order Squaliformes, Family Somniosidae: sleeper sharks									
<i>Centroscymnus coelolepis</i>	Portuguese shark			on/near bottom, deep water, cont. slopes	270 to 3675				Compagno 1984
<i>Somniosus microcephalus</i>	Greenland shark			littoral/ epibenthic/ intertidal	<120		move into shallower water in spring/ summer		Compagno 1984
<i>Somniosus pacificus</i>	Pacific sleeper shark			cont. shelf, littoral/ intertidal/ epibenthic	shallow to 2000				Compagno 1984
Order Squaliformes, Family Dalatiidae: kitefin sharks									
<i>Dalatias licha</i>	kitefin shark			on/near bottom, deep water, OCS	37 to 1800				Compagno 1984
Order Squantiformes, Family Squatinidae: angel sharks									
<i>Squatina californica</i>	Pacific angel shark			continental/ littoral/ benthic	3 to 46				Compagno 1984
<i>Squatina dumeril</i>	Atlantic angel shark		S	on/near bottom, shelf slope	inshore to 1390				Compagno 1984
Order Heterodontiformes, Family Heterodontidae: bullhead sharks									
<i>Heterodontus francisci</i>	horn shark			benthic/ epibenthic	2 to 250				Compagno 1984
Order Orectolobiformes, Family Ginglymostomatidae: nurse sharks									
<i>Ginglymostoma cirratum</i>	nurse shark		S	inshore/ intertidal, bottom of cont./ insular shelves	<1 to 12				Compagno 1984
Order Orectolobiformes, Family Rhincodontidae: whale sharks									
<i>Rhincodon typus</i>	whale shark		S	epipelagic/ oceanic/ coastal/ lagoons/ coral atolls					Compagno 1984

Appendix Table C-2 Natural history characteristics of elasmobranch species in US waters. (continued)

Species	Common Name	Status ^a	EFH ^b	Habitat	Depth (m)	Movement	Seasonal Occurrence	Lifestage Occurrence	Citation
Order Lamniformes, Family Mitsukurinidae: goblin sharks									
<i>Mitsukurina owstoni</i>	goblin shark			bottom, OCS	up to at least 550				Compagno 1984
Order Lamniformes, Family Odontaspidae: sand tigers									
<i>Carcharias taurus</i>	sand tiger		S	on/near bottom to surface, littoral/ surf zone, shallow bays	surf zone to 191				Compagno 1984
<i>Odontaspis ferox</i>	ragged-tooth shark			on/near bottom, deep cont/ insular shelves	13 to 420				Compagno 1984
<i>Odontaspis noronhai</i>	bigeye sand tiger		S	benthic	>600				Compagno 2001
Order Lamniformes, Family Megachasmidae: megamouth sharks									
<i>Megachasma pelagios</i>	megamouth shark			epipelagic	5 to 4600	diel migration			Compagno 2001
Order Lamniformes, Family Alopiidae: thresher sharks									
<i>Alopias superciliosus</i>	bigeye thresher		P, S	epipelagic, neritic, epibenthic, oceanic/ coastal/ cont. shelf	0 to 500				Compagno 1984
<i>Alopias vulpinus</i>	thresher shark		P, S	epipelagic, oceanic/ coastal/ cont. shelf	0 to 366				Compagno 1984
Order Lamniformes, Family Cetorhinidae: basking sharks									
<i>Cetorhinus maximus</i>	basking shark		S	just off surf zone, coastal/ pelagic cont. shelf	at/near surface				Compagno 1984
Order Lamniformes, Family Lamnidae: mackerel sharks									
<i>Carcharodon carcharias</i>	white shark		S	surface to bottom, coastal/ offshore cont. and insular shelves	0 to 1280				Compagno 1984
<i>Isurus oxyrinchus</i>	shortfin mako		P, S	littoral, epipelagic, coastal/ oceanic	surface to at least 152				Compagno 1984
<i>Isurus paucus</i>	longfin mako		S	oceanic/ tropical/ epipelagic	na				Compagno 1984

Appendix Table C-2 Natural history characteristics of elasmobranch species in US waters. (continued)

Species	Common Name	Status ^a	EFH ^b	Habitat	Depth (m)	Movement	Seasonal Occurrence	Lifestage Occurrence	Citation
<i>Lamna ditropis</i>	salmon shark			coastal/ oceanic/ littoral/ epipelagic	0 to 152				Compagno 1984
<i>Lamna nasus</i>	porbeagle		S	littoral/ epipelagic/ cont. shelf offshore	0 to 366				Compagno 1984
Order Carcharhiniformes, Family Scyliorhinidae: cat sharks									
<i>Apristurus brunneus</i>	brown cat shark			deepwater/ OCS, bottom dwelling	33 to 950				Compagno 1984
<i>Cephaloscyllium ventriosum</i>	swell shark			nocturnal/ benthic/ epibenthic/ cont. shelf inshore	inshore to 457				Compagno 1984
<i>Galeus arae</i>	marbled cat shark			deepwater/ bottom dwelling	292 to 732				Compagno 1984
<i>Parmaturus xaniurus</i>	filetail cat shark			on/near bottom, deepwater, OCS	91 to 1251				Compagno 1984
<i>Scyliorhinus retifer</i>	chain dogfish			deepwater, OCS, near bottom	73 to 550				Compagno 1984
Order Carcharhiniformes, Family Pseudotriakidae: false cat sharks									
<i>Pseudotriakis microdon</i>	false cat shark			deep water, bottom	200 to 1500				Compagno 1984
Order Carcharhiniformes, Family Triakidae: hound sharks									
<i>Galeorhinus galeus</i>	tope		P	coastal/ pelagic	2 to 471	highly migratory in higher latitudes			Compagno 1984
<i>Mustelus californicus</i>	gray smoothhound			benthic, inshore/ offshore cont. shelf			summer visitor		Compagno 1984
<i>Mustelus canis</i>	smooth dogfish			epipelagic, inshore/ intertidal cont. shelf	intertidal to 200				Compagno 1984
<i>Mustelus henlei</i>	brown smoothhound			inshore/ offshore bottom dwelling, intertidal	intertidal to 200				Compagno 1984
<i>Mustelus lunulatus</i>	sicklefin smoothhound			bottom dwelling, inshore/ offshore					Compagno 1984

Appendix Table C-2 Natural history characteristics of elasmobranch species in US waters. (continued)

Species	Common Name	Status ^a	EFH ^b	Habitat	Depth (m)	Movement	Seasonal Occurrence	Lifestage Occurrence	Citation
<i>Mustelus norrisi</i>	Florida smoothhound			bottom dwelling, close inshore, cont. shelf	inshore to 80				Compagno 1984
<i>Mustelus sinusmexicanus</i>	Gulf smoothhound			pelagic/ oceanic, marine	20 to 250 (usually 42 to 91)				Froese and Pauly 2010
<i>Triakis semifasciata</i>	leopard shark		P	inshore/ offshore continental shelf, littoral, near bottom,	intertidal to 91				Compagno 1984
Order Carcharhiniformes, Family Carcharhinidae: requiem sharks									
<i>Carcharhinus acronotus</i>	blacknose shark		S	over sandy, shell bottom, coastal cont./ insular shelves	na			pregnant females SW FL Jan-Apr	Compagno 1984
<i>Carcharhinus altimus</i>	bignose shark		S	offshore, bottom dwelling, deeper waters near shelf edges	90 to 250/430				Compagno 1984
<i>Carcharhinus brachyurus</i>	narrowtooth shark		S	inshore/ offshore	surflines to 100	migratory	north in spring/ summer, south in fall/ winter		Compagno 1984
<i>Carcharhinus brevipinna</i>	spinner shark		S	coastal/ pelagic cont./ insular shelf waters	<30, but sometimes to 75				Compagno 1984
<i>Carcharhinus falciformis</i>	silky shark		S	oceanic/ coastal, epipelagic/ littoral near shelf edge and open sea	18 to 500				Compagno 1984
<i>Carcharhinus galapagensis</i>	Galapagos shark		S	circumtropical assoc. with oceanic islands	na				Compagno 1984

Appendix Table C-2 Natural history characteristics of elasmobranch species in US waters. (continued)

Species	Common Name	Status ^a	EFH ^b	Habitat	Depth (m)	Movement	Seasonal Occurrence	Lifestage Occurrence	Citation
<i>Carcharhinus isodon</i>	finetooth shark		S	close inshore	na	moves north along east coast in summer			Compagno 1984
<i>Carcharhinus leucas</i>	bull shark		S	coastal, estuarine, riverine, lacustrine, far up warm rivers/ freshwater lakes	<1 to 30	migratory			Compagno 1984
<i>Carcharhinus limbatus</i>	blacktip shark		S	close inshore, off river mouths and estuaries, offshore	<30				Compagno 1984
<i>Carcharhinus longimanus</i>	oceanic whitetip shark		S	coastal/ pelagic/ oceanic	37 to 152				Compagno 1984
<i>Carcharhinus obscurus</i>	dusky shark		S	coastal/ pelagic, inshore/ offshore, cont/ insular shelves	surf zone to <400	strongly migratory			Compagno 1984
<i>Carcharhinus perezii</i>	reef shark		S	assoc. with coral reefs in Caribbean, inshore, bottom dwelling	<30				Compagno 1984
<i>Carcharhinus plumbeus</i>	sandbar shark		S	coastal/ pelagic, bay mouths, harbors	intertidal to 280	annual migration			Compagno 1984
<i>Carcharhinus porosus</i>	smalltail shark		S	inshore estuaries, cont. shelf, near bottom	<36				Compagno 1984
<i>Carcharhinus signatus</i>	night shark		S	deepwater, coastal, semi-oceanic	50 to 100 (sometimes 600)				Compagno 1984
<i>Galeocerdo cuvier</i>	tiger shark		S	coastal, pelagic, estuary, wide tolerance for different marine habitats	intertidal to 140				Compagno 1984

Appendix Table C-2 Natural history characteristics of elasmobranch species in US waters. (continued)

Species	Common Name	Status ^a	EFH ^b	Habitat	Depth (m)	Movement	Seasonal Occurrence	Lifestage Occurrence	Citation
<i>Negaprion brevirostris</i>	lemon shark		S	sand/mud bottom, coastal/ inshore cont. shelf, mangrove fringes	intertidal to 92				Compagno 1984
<i>Prionace glauca</i>	blue shark		P, S	oceanic, epipelagic, fringe-littoral	<152				Compagno 1984
<i>Rhizoprionodon longurio</i>	Pacific sharpnose shark			littoral, cont. shelf	intertidal to 27				Compagno 1984
<i>Rhizoprionodon terraenovae</i>	Atlantic sharpnose shark		S	coastal, marine/ brackish	intertidal to 280				Compagno 1984
Order Carcharhiniformes, Family Sphyrnidae: hammerhead sharks									
<i>Sphyrna lewini</i>	scalloped hammerhead		S	coastal/ pelagic/ semi-oceanic, cont. shelf, bays/ estuaries	intertidal to 275				Compagno 1984
<i>Sphyrna mokarran</i>	great hammerhead		S	coastal/ pelagic, semi-oceanic, close inshore/ offshore	>80	migratory			Compagno 1984
<i>Sphyrna tiburo</i>	bonnethead		S	over mud and sand bottom, inshore/ coastal, estuaries	10 to 80	migratory			Compagno 1984
<i>Sphyrna zygaena</i>	smooth hammerhead		S	coastal/ pelagic, semi-oceanic	<20				Compagno 1984
Order Torpediniformes, Family Narcinidae: electric rays									
<i>Narcine bancroftii</i>	lesser electric ray			demersal, marine	na				Froese and Pauly 2010
Order Torpediniformes, Family Torpedinidae: torpedo electric rays									
<i>Torpedo californica</i>	Pacific electric ray			demersal, marine	0 to 425 (most common 3 to 200)				Froese and Pauly 2010
<i>Torpedo nobiliana</i>	Atlantic torpedo			benthopelagic, cont. shelf	2 to 800 (usually 10 to 150)				Froese and Pauly 2010

Appendix Table C-2 Natural history characteristics of elasmobranch species in US waters. (continued)

Species	Common Name	Status ^a	EFH ^b	Habitat	Depth (m)	Movement	Seasonal Occurrence	Lifestage Occurrence	Citation
Order Pristiformes, Family Pristidae: sawfishes									
<i>Pristis pectinata</i>	smalltooth sawfish	E		demersal, freshwater, brackish, marine	<10, and in FL Keys 70 to 122	adults observed north of FL will likely migrate to FL in fall	temperature limited 16-18 °C, FL Keys winter habitat?	juveniles shallow mud/sand banks, adults coastal to deeper shelf waters	Froese and Pauly 2010
<i>Pristis pristis</i>	largetooth sawfish			inshore/ coastal, demersal, freshwater, brackish, marine					Froese and Pauly 2010
Order Rajiformes, Family Rhinobatidae: guitarfishes									
<i>Rhinobatos lentiginosus</i>	Atlantic guitarfish			assoc. with reefs, marine	0 to 30				Froese and Pauly 2010
<i>Rhinobatos productus</i>	shovelnose guitarfish			tropical, demersal, brackish, marine	1 to 91 (usually 1 to 13)				Froese and Pauly 2010
<i>Zapteryx exasperata</i>	banded guitarfish			assoc. with reefs, marine	1 to 200 (usually 1 to 22)				Froese and Pauly 2010
Order Rajiformes, Family Platyrhynidae: thornbacks									
<i>Platyrhinoidis triseriata</i>	thornback			subtropical, demersal, marine	0 to 50				Froese and Pauly 2010
Order Rajiformes, Family Rajidae: skates									
<i>Amblyraja radiata</i>	thorny skate		NE/MA	boreal/ arctic	18 to 1200	seasonal migration			Packer 2003a
<i>Bathyraja aleutica</i>	Aleutian skate			bathodemersal, deep water marine	15 to 1602				Froese and Pauly 2010
<i>Bathyraja interrupta</i>	sandpaper skate			bathodemersal, marine	23 to 1500				Froese and Pauly 2010
<i>Bathyraja lindbergi</i>	Commander skate			demersal, marine, temperate	126 to 1193				Froese and Pauly 2010

Ap Appendix Table C-2 Natural history characteristics of elasmobranch species in US waters. (continued)

Species	Common Name	Status ^a	EFH ^b	Habitat	Depth (m)	Movement	Seasonal Occurrence	Lifestage Occurrence	Citation
<i>Bathyraja maculata</i>	whiteblotched skate			bathydemersal, marine	70 to 1193				Froese and Pauly 2010
<i>Bathyraja parmifera</i>	Alaska skate			temperate, demersal, marine	20 to 1450 (usually 120 to 450)				Froese and Pauly 2010
<i>Bathyraja spinicauda</i>	spinytail skate			bathydemersal, marine	140 to 1463 (usually 165 to 255)				Froese and Pauly 2010
<i>Bathyraja taranetzi</i>	mud skate			bathydemersal	58 to 1054				Froese and Pauly 2010
<i>Bathyraja violacea</i>	Okhotsk skate			demersal	20 to 1110				Froese and Pauly 2010
<i>Dipturus bullisi</i>	lozenge skate			bathydemersal, marine	200 to 600				Froese and Pauly 2010
<i>Dipturus laevis</i>	barndoor skate		NE/MA	mud, sand, gravel bottom	from shoreline to 750				Packer 2003b
<i>Dipturus olsenii</i>	spreadfin skate			demersal, marine	91 to 238				Froese and Pauly 2010
<i>Leucoraja erinacea</i>	little skate		NE/MA	inshore/ offshore on bottom	<73 to 91, as deep as 329				Packer 2003c
<i>Leucoraja garmani</i>	rosette skate		NE/MA	marine, demersal	33 to 530				Packer 2003d
<i>Leucoraja lentiginosa</i>	freckled skate			marine, demersal	53 to 457				Froese and Pauly 2010
<i>Leucoraja ocellata</i>	winter skate		NE/MA	marine, demersal	shore to 371, most abundant <111				Packer 2003e
<i>Leucoraja virginica</i>	Virginia skate			benthopelagic, marine	104 to 117				Froese and Pauly 2010
<i>Malacoraja senta</i>	smooth skate		NE/MA	demersal, marine, boreal	31 to 874 (most abundant 110 to 457)				Packer 2003f

Appendix Table C-2 Natural history characteristics of elasmobranch species in US waters. (continued)

Species	Common Name	Status ^a	EFH ^b	Habitat	Depth (m)	Movement	Seasonal Occurrence	Lifestage Occurrence	Citation
<i>Raja ackleyi</i>	ocellate skate			demersal/ benthic, marine, tropical	<45				Froese and Pauly 2010
<i>Raja binoculata</i>	big skate		P	temperate, demersal, marine	3 to 800				Froese and Pauly 2010
<i>Raja eglanteria</i>	cleannose skate		NE/MA	inshore/ offshore on bottom	<329, most abundant sublittoral to 55				Packer 2003g
<i>Raja inornata</i>	California skate		P	demersal, marine, deep, and inshore shallow bays	18 to 671				Froese and Pauly 2010
<i>Raja rhina</i>	longnose skate		P	bathydemersal, marine, deep water	9 to 1069				Froese and Pauly 2010
<i>Raja stellulata</i>	starry skate			demersal, marine, temperate	18 to 732				Froese and Pauly 2010
<i>Raja texana</i>	roundel skate			demersal, marine, subtropical	<183				Froese and Pauly 2010
Order Myliobatiformes, Family Dasyatidae: whiptail stingrays									
<i>Dasyatis americana</i>	southern stingray			assoc. with reefs, brackish, marine, bays and estuaries	0 to 53				Froese and Pauly 2010
<i>Dasyatis centroura</i>	rougthead stingray			demersal, temperate/ tropical	nearshore to 91				Collette and Klein-MacPhee 2002
<i>Dasyatis dipterura</i>	diamond stingray			demersal, marine, subtropical					Froese and Pauly 2010
<i>Dasyatis sabina</i>	Atlantic stingray			demersal, coastal, brackish, marine, subtropical	< 25 (usually 2 to 6)				Froese and Pauly 2010
<i>Dasyatis say</i>	bluntnose stingray			demersal, marine, subtropical, coastal, nearshore	1 to 10				Froese and Pauly 2010

Appendix Table C-2 Natural history characteristics of elasmobranch species in US waters. (continued)

Species	Common Name	Status ^a	EFH ^b	Habitat	Depth (m)	Movement	Seasonal Occurrence	Lifestage Occurrence	Citation
<i>Pteroplatytrygon violacea</i>	pelagic stingray			pelagic/ oceanic, marine, subtropical	1 to 381 (usually 1 to 100)				Froese and Pauly 2010
Order Myliobatiformes, Family Urolophidae: round stingrays									
<i>Urobatis halleri</i>	round stingray			demersal, marine, subtropical, off beaches and bays	0 to 91 (usually <15)				Froese and Pauly 2010
<i>Urobatis jamaicensis</i>	yellow stingray			assoc. with reefs, marine, tropical	1 to 25				Froese and Pauly 2010
Order Myliobatiformes, Family Gymnuridae: butterfly rays									
<i>Gymnura altavela</i>	spiny butterfly ray			demersal, brackish, marine, subtropical	5 to 100				Froese and Pauly 2010
<i>Gymnura marmorata</i>	California butterfly ray			demersal, marine, subtropical, shallow bays and beaches					Froese and Pauly 2010
<i>Gymnura micrura</i>	smooth butterfly ray			demersal, brackish, marine, neritic	<40				Froese and Pauly 2010
Order Myliobatiformes, Family Myliobatidae: eagle rays									
<i>Aetobatus narinari</i>	spotted eagle ray			assoc. with reefs, brackish, marine, shallow/ inshore	1 to 80				Froese and Pauly 2010
<i>Myliobatis californica</i>	bat ray			demersal, marine, subtropical	0 to 46				Froese and Pauly 2010
<i>Myliobatis freminvillei</i>	bullnose ray			benthopelagic, brackish, marine, subtropical	0 to 100 (usually 1 to 10)				Froese and Pauly 2010
<i>Myliobatis goodei</i>	southern eagle ray			benthopelagic, marine, coastal, tropical	1 to 130				Froese and Pauly 2010
Order Myliobatiformes, Family Rhinopteridae: cownose rays									
<i>Rhinoptera bonasus</i>	cownose ray			benthopelagic		migratory			Froese and Pauly 2010

Appendix Table C-2 Natural history characteristics of elasmobranch species in US waters. (continued)

Species	Common Name	Status ^a	EFH ^b	Habitat	Depth (m)	Movement	Seasonal Occurrence	Lifestage Occurrence	Citation
Order Myliobatiformes, Family Mobulidae: mantas									
<i>Manta birostris</i>	giant manta			at/ near surface and bottom over cont./ insular shelves					Collette and Klein-MacPhee 2002
<i>Mobula hypostoma</i>	devil ray			pelagic, neritic, marine, tropical, shallow, coastal					Froese and Pauly 2010
<i>Mobula japonica</i>	spinetail mobula			assoc. with reefs, marine, subtropical, inshore/ oceanic					Froese and Pauly 2010
<i>Mobula tarapacana</i>	sicklefin devil ray			reef-associated; oceanodromous	0 to 30; open ocean				Froese and Pauly 2010; Clark et al. 2006

^a Status= threatened (T) or endangered (E);

^b EFH=Essential Fish Habitat has been designated by the listed Fishery Management Council: NP=North Pacific, P=Pacific, NE/MA=New England/Mid-Atlantic, SA=South Atlantic, G=Gulf of Mexico, and S=Secretarial (NMFS 2010b).

Appendix Table C-3

Geographic range of elasmobranch species in US waters

Species	Common name	Geographic range	Critical/ important areas	Citation
Class Chondrichthyes, Subclass Elasmobranchii: sharks, skates, and rays				
Order Hexanchiformes, Family Chlamydoselachidae: frill sharks				
<i>Chlamydoselachus anguineus</i>	frill shark	S. CA		Compagno 1984
Order Hexanchiformes, Family Hexanchidae: cow sharks				
<i>Hepranchias perlo</i>	sharpnose sevengill shark	W. N. Atl, NC to FL, G. of Mex		Compagno 1984
<i>Hexanchus griseus</i>	bluntnose sixgill shark	NC to FL; G. of Mex		Compagno 1984
<i>Hexanchus nakamurai</i>	bigeye sixgill shark	W. N. Atl		Compagno 1984
<i>Notorynchus cepedianus</i>	broadnose sevengill shark	WA to S. CA		Compagno 1984
Order Squaliformes, Family Echinorhinidae: bramble sharks				
<i>Echinorhinus brucus</i>	bramble shark	VA to MA		Compagno 1984
<i>Echinorhinus cookei</i>	prickly shark	central CA		Compagno 1984
Order Squaliformes, Family Squalidae: dogfish sharks				
<i>Cirrhigaleus asper</i>	roughskin dogfish	W. N. Atl, NC to FL, G. of Mex		Compagno 1984
<i>Squalus acanthias</i>	spiny dogfish, spurdog	ME to FL		Compagno 1984
<i>Squalus cubensis</i>	Cuban dogfish	NC to FL, G. of Mex		Compagno 1984
Order Squaliformes, Family Etmopteridae: lantern sharks				
<i>Centroscyllium fabricii</i>	black dogfish	ME to VA, G. of Mex (?)		Compagno 1984
<i>Etmopterus bigelowi</i>	blurred lantern shark	G. of Mex		Compagno 1984
<i>Etmopterus gracilispinis</i>	broadband lantern shark	W. N. Atl, VA to FL		Compagno 1984
Order Squaliformes, Family Somniosidae: sleeper sharks				
<i>Centroscymnus coelolepis</i>	Portuguese shark			Compagno 1984
<i>Somniosus microcephalus</i>	Greenland shark	N. Atl., MA to ME		Compagno 1984
<i>Somniosus pacificus</i>	Pacific sleeper shark	Bering Sea to S. CA		Compagno 1984
Order Squaliformes, Family Dalatiidae: kitefin sharks				
<i>Dalatias licha</i>	kitefin shark	W. N. Atl., Georges Bank, G. of Mex		Compagno 1984

Appendix Table C-3 Geographic range of elasmobranch species in US waters. (continued)

Species	Common name	Geographic range	Critical/ important areas	Citation
Order Squantiformes, Family Squatinidae: angel sharks				
<i>Squatina californica</i>	Pacific angel shark	SE AK to Gulf of CA		Compagno 1984
<i>Squatina dumeril</i>	Atlantic angel shark	S. New Eng. to G. of Mex		Compagno 1984
Order Heterodontiformes, Family Heterodontidae: bullhead sharks				
<i>Heterodontus francisci</i>	horn shark	central/S. CA and G. of Mex		Compagno 1984
Order Orectolobiformes, Family Ginglymostomatidae: nurse sharks				
<i>Ginglymostoma cirratum</i>	nurse shark	RI to G. of Mex		Compagno 1984
Order Orectolobiformes, Family Rhincodontidae: whale sharks				
<i>Rhincodon typus</i>	whale shark	W. N. Atl., NY to G. of Mex		Compagno 1984
Order Lamniformes, Family Mitsukurinidae: goblin sharks				
<i>Mitsukurina owstoni</i>	goblin shark	S. CA		Compagno 1984
Order Lamniformes, Family Odontaspidae: sand tigers				
<i>Carcharias taurus</i>	sand tiger	W. N. Atl, G. of Mex		Compagno 1984
<i>Odontaspis ferox</i>	ragged-tooth shark	S. CA		Compagno 1984
<i>Odontaspis noronhai</i>	bigeye sand tiger	rare: S. Atl, G. of Mex		Compagno 2001
Order Lamniformes, Family Megachasmidae: megamouth sharks				
<i>Megachasma pelagios</i>	megamouth shark	rare: S. CA		Compagno 2001
Order Lamniformes, Family Alopiidae: thresher sharks				
<i>Alopias superciliosus</i>	bigeye thresher	NY to FL; S. CA		Compagno 1984
<i>Alopias vulpinus</i>	thresher shark	ME to FL, G. of Mex, BC to S. CA		Compagno 1984
Order Lamniformes, Family Cetorhinidae: basking sharks				
<i>Cetorhinus maximus</i>	basking shark	W. N. Atl. ME to FL, G of AK to S. CA		Compagno 1984
Order Lamniformes, Family Lamnidae: mackerel sharks				
<i>Carcharodon carcharias</i>	white shark	W. N. Atl. ME to FL, G. of Mex, G of Mex, G. of AK to S. CA		Compagno 1984
<i>Isurus oxyrinchus</i>	shortfin mako	G. of ME to FL, S. CA and WA		Compagno 1984
<i>Isurus paucus</i>	longfin mako	W. N. Atl to FL		Compagno 1984
<i>Lamna ditropis</i>	salmon shark	Bering Sea to S. CA		Compagno 1984
<i>Lamna nasus</i>	porbeagle	ME to SC		Compagno 1984

Appendix Table C-3 Geographic range of elasmobranch species in US waters. (continued)

Species	Common name	Geographic range	Critical/ important areas	Citation
Order Carcharhiniformes, Family Scyliorhinidae: cat sharks				
<i>Apristurus brunneus</i>	brown cat shark	WA to S. CA		Compagno 1984
<i>Cephaloscyllium ventriosum</i>	swell shark	central to S. CA		Compagno 1984
<i>Galeus arae</i>	marbled cat shark	W. N Atl., SC to FL, G of Mex		Compagno 1984
<i>Parmaturus xaniurus</i>	filetail cat shark	WA to central CA		Compagno 1984
<i>Scyliorhinus retifer</i>	chain dogfish	S. New Eng to FL, G. Mex		Compagno 1984
Order Carcharhiniformes, Family Pseudotriakidae: false cat sharks				
<i>Pseudotriakis microdon</i>	false cat shark	NY to NJ		Compagno 1984
Order Carcharhiniformes, Family Triakidae: hound sharks				
<i>Galeorhinus galeus</i>	tope	WA to S.CA		Compagno 1984
<i>Mustelus californicus</i>	gray smoothhound	E. N Pac, N. CA to S. CA		Compagno 1984
<i>Mustelus canis</i>	smooth dogfish	MA to FL, G.of Mex		Compagno 1984
<i>Mustelus henlei</i>	brown smoothhound	N to S CA		Compagno 1984
<i>Mustelus lunulatus</i>	sicklefin smoothhound	S CA		Compagno 1984
<i>Mustelus norrisi</i>	Florida smoothhound	FL, G. of Mex		Compagno 1984
<i>Mustelus sinusmexicanus</i>	Gulf smoothhound	G. of Mex		Froese and Pauly 2010
<i>Triakis semifasciata</i>	leopard shark	OR, CA		Compagno 1984
Order Carcharhiniformes, Family Carcharhinidae: requiem sharks				
<i>Carcharhinus acronotus</i>	blacknose shark	NC to FL, G. of Mex		Compagno 1984
<i>Carcharhinus altimus</i>	bignose shark	FL		Compagno 1984
<i>Carcharhinus brachyurus</i>	narrowtooth shark	W. Atl, G. of Mex, S. CA		Compagno 1984
<i>Carcharhinus brevipinna</i>	spinner shark	NC to FL, G. of Mex		Compagno 1984
<i>Carcharhinus falciformis</i>	silky shark	MA to FL, G. of Mex		Compagno 1984
<i>Carcharhinus galapagensis</i>	Galapagos shark	Bermuda, Virgin Islands		Compagno 1984

Appendix Table C-3 Geographic range of elasmobranch species in US waters. (continued)

Species	Common name	Geographic range	Critical/ important areas	Citation
<i>Carcharhinus isodon</i>	finetooth shark	NY and NC to FL		Compagno 1984
<i>Carcharhinus leucas</i>	bull shark	MA to FL, G. of Mex, Mississippi and Atchafalaya Rivers		Compagno 1984
<i>Carcharhinus limbatus</i>	blacktip shark	MA to FL, G. of Mex, S. CA		Compagno 1984
<i>Carcharhinus longimanus</i>	oceanic whitetip shark	MA to FL, G. of Mex, S. CA		Compagno 1984
<i>Carcharhinus obscurus</i>	dusky shark	S. MA, Georges Bank to FL, S. CA		Compagno 1984
<i>Carcharhinus perezii</i>	reef shark	FL, G. of Mex		Compagno 1984
<i>Carcharhinus plumbeus</i>	sandbar shark	MA to FL, G. of Mex	HAPC has been designated by Secretarial FMC in certain shallow areas from NJ to NC	Compagno 1984
<i>Carcharhinus porosus</i>	smalltail shark	G. of Mex		Compagno 1984
<i>Carcharhinus signatus</i>	night shark	DE to FL		Compagno 1984
<i>Galeocerdo cuvier</i>	tiger shark	MA to FL, G. of Mexico		Compagno 1984
<i>Negaprion brevirostris</i>	lemon shark	NJ to FL, G. of Mex		Compagno 1984
<i>Prionace glauca</i>	blue shark	G. of Mex, AK to S. CA		Compagno 1984
<i>Rhizoprionodon longurio</i>	Pacific sharpnose shark	S. CA		Compagno 1984
<i>Rhizoprionodon terraenovae</i>	Atlantic sharpnose shark	ME to FL, G. of Mex		Compagno 1984
Order Carcharhiniformes, Family Sphyrnidae: hammerhead sharks				
<i>Sphyrna lewini</i>	scalloped hammerhead	NJ to FL, G. of Mex, S. CA		Compagno 1984
<i>Sphyrna mokarran</i>	great hammerhead	NC to FL		Compagno 1984
<i>Sphyrna tiburo</i>	bonnethead	RI and NC to FL, S. CA		Compagno 1984
<i>Sphyrna zygaena</i>	smooth hammerhead	ME to FL, N. CA to S. CA		Compagno 1984
Order Torpediniformes, Family Narcinidae: electric rays				
<i>Narcine bancroftii</i>	lesser electric ray	NC to FL, G. of Mex		Froese and Pauly 2010
Order Torpediniformes, Family Torpedinidae: torpedo electric rays				
<i>Torpedo californica</i>	Pacific electric ray	WA to S. CA		Froese and Pauly 2010
<i>Torpedo nobiliana</i>	Atlantic torpedo	ME to FL		Froese and Pauly 2010

Appendix Table C-3 Geographic range of elasmobranch species in US waters. (continued)

Species	Common name	Geographic range	Critical/ important areas	Citation
Order Pristiformes, Family Pristidae: sawfishes				
<i>Pristis pectinata</i>	smalltooth sawfish	historical and rare reports north of FL, core range = peninsular FL	Critical habitat designated for southwest coastal FL, Charlotte Harbor Estuary Unit and the Ten Thousand Islands/Everglades Unit	Froese and Pauly 2010
<i>Pristis pristis</i>	largetooth sawfish	Extirpated in US?, G. of Mex		Froese and Pauly 2010
Order Rajiformes, Family Rhinobatidae: guitarfishes				
<i>Rhinobatos lentiginosus</i>	Atlantic guitarfish	NC to G. of Mexico		Froese and Pauly 2010
<i>Rhinobatos productus</i>	shovelnose guitarfish	C. CA to S. CA		Froese and Pauly 2010
<i>Zapteryx exasperata</i>	banded guitarfish	S. CA		Froese and Pauly 2010
Order Rajiformes, Family Platyrhynidae: thornbacks				
<i>Platyrhinoidis triseriata</i>	thornback	C. CA to S. CA		Froese and Pauly 2010
Order Rajiformes, Family Rajidae: skates				
<i>Amblyraja radiata</i>	thorny skate	ME to SC		Packer 2003a
<i>Bathyraja aleutica</i>	Aleutian skate	Aleutian Isl., AK		
<i>Bathyraja interrupta</i>	sandpaper skate	Bering Sea, AK; S. CA		Froese and Pauly 2010
<i>Bathyraja lindbergi</i>	Commander skate	Bering Sea		Froese and Pauly 2010
<i>Bathyraja maculata</i>	whiteblotched skate	Bering Sea		Froese and Pauly 2010
<i>Bathyraja parmifera</i>	Alaska skate	Bering Sea to S.E. AK		Froese and Pauly 2010
<i>Bathyraja spinicauda</i>	spinytail skate	ME to MA		Froese and Pauly 2010
<i>Bathyraja taranetzi</i>	mud skate	Aleutian Isl., AK		Froese and Pauly 2010
<i>Bathyraja violacea</i>	Okhotsk skate	Aleutian Isl., AK		Froese and Pauly 2010
<i>Dipturus bullisi</i>	lozenge skate	S. FL		Froese and Pauly 2010
<i>Dipturus laevis</i>	barndoor skate	ME to NC		Packer 2003b
<i>Dipturus olseni</i>	spreadfin skate	N. G. of Mex, FL to TX		Froese and Pauly 2010
<i>Leucoraja erinacea</i>	little skate	ME to NC		Packer 2003c
<i>Leucoraja garmani</i>	rosette skate	MA to FL, very abundant NC to FL		Packer 2003d
<i>Leucoraja lentiginosa</i>	freckled skate	NC to G. of Mex		Froese and Pauly 2010
<i>Leucoraja ocellata</i>	winter skate	ME to MC		Packer 2003e

Appendix Table C-3 Geographic range of elasmobranch species in US waters. (continued)

Species	Common name	Geographic range	Critical/ important areas	Citation
<i>Leucoraja virginica</i>	Virginia skate	N.W. Atlantic		Froese and Pauly 2010
<i>Malacoraja senta</i>	smooth skate	ME to MA		Packer 2003f
<i>Raja ackleyi</i>	ocellate skate	FL, G. of Mex		Froese and Pauly 2010
<i>Raja binoculata</i>	big skate	Aleutian Isl., AK, to S. CA		Froese and Pauly 2010
<i>Raja eglanteria</i>	clearnose skate	G. of ME to NC		Packer 2003g
<i>Raja inornata</i>	California skate	WA to S. CA		Froese and Pauly 2010
<i>Raja rhina</i>	longnose skate	Aleut. Isls., AK to S. CA		Froese and Pauly 2010
<i>Raja stellulata</i>	starry skate	Aleut. Isls., AK to S. CA		Froese and Pauly 2010
<i>Raja texana</i>	roundel skate	FL to G. of Mex		Froese and Pauly 2010
Order Myliobatiformes, Family Dasyatidae: whiptail stingrays				
<i>Dasyatis americana</i>	southern stingray	NJ to FL and G. of Mex		Froese and Pauly 2010
<i>Dasyatis centroura</i>	rougthead stingray	MA to FL, W. G. of Mex		Collette and Klein-MacPhee 2002
<i>Dasyatis dipterura</i>	diamond stingray	S. CA		Froese and Pauly 2010
<i>Dasyatis sabina</i>	Atlantic stingray	VA to FL and G. of Mex		Froese and Pauly 2010
<i>Dasyatis say</i>	bluntnose stingray	NJ to FL and G. of Mex		Froese and Pauly 2010
<i>Pteroplatytrygon violacea</i>	pelagic stingray	CA, maybe W. Atl.?		Froese and Pauly 2010
Order Myliobatiformes, Family Urolophidae: round stingrays				
<i>Urobatis halleri</i>	round stingray	N. CA to S. CA		Froese and Pauly 2010
<i>Urobatis jamaicensis</i>	yellow stingray	NC to FL		Froese and Pauly 2010
Order Myliobatiformes, Family Gymnuridae: butterfly rays				
<i>Gymnura altavela</i>	spiny butterfly ray	MA to TX		Froese and Pauly 2010
<i>Gymnura marmorata</i>	California butterfly ray	CA		Froese and Pauly 2010
<i>Gymnura micrura</i>	smooth butterfly ray	MD to TX		Froese and Pauly 2010
Order Myliobatiformes, Family Myliobatidae: eagle rays				
<i>Aetobatus narinari</i>	spotted eagle ray	NC to TX		Froese and Pauly 2010
<i>Myliobatis californica</i>	bat ray	OR to S. CA		Froese and Pauly 2010
<i>Myliobatis freminvillei</i>	bullnose ray	MA to FL (maybe G. of Mex?)		Froese and Pauly 2010
<i>Myliobatis goodei</i>	southern eagle ray	SC to FL		Froese and Pauly 2010

Appendix Table C-3 Geographic range of elasmobranch species in US waters. (continued)

Species	Common name	Geographic range	Critical/ important areas	Citation
Order Myliobatiformes, Family Rhinopteridae: cownose rays				
<i>Rhinoptera bonasus</i>	cownose ray	MA to FL		Froese and Pauly 2010
Order Myliobatiformes, Family Mobulidae: mantas				
<i>Manta birostris</i>	giant manta	MA to NC, G. of Mex		Collette and Klein-MacPhee 2002
<i>Mobula hypostoma</i>	devil ray	NJ to FL, G. of Mex		Froese and Pauly 2010
<i>Mobula japanica</i>	spinetail mobula	WA to CA		Froese and Pauly 2010
<i>Mobula tarapacana</i>	sicklefin devil ray	rare: reported from Texas		Froese and Pauly 2010; Clark et al. 2006

Appendix Table C-4

Geographic distribution of elasmobranch species within MMS planning areas and regions of Alaska.

Species	Common Name	Geographic Region ^a												
		North Atlantic	Mid Atlantic	South Atlantic	Straits of Florida	Eastern Gulf of Mexico	Central Gulf of Mexico	Western Gulf of Mexico	Southern California	Central California	Northern California	Washington/Oregon	Alaska (Aleutian Islands)	Alaska (Frontier)
Class Chondrichthyes, Subclass Elasmobranchii: sharks, skates, and rays														
Order Hexanchiformes, Family Chlamydoselachidae: frill sharks														
<i>Chlamydoselachus anguineus</i>	frill shark								x					
Order Hexanchiformes, Family Hexanchidae: cow sharks														
<i>Hepranchias perlo</i>	sharpnose sevengill shark		x	x		x	x	x						
<i>Hexanchus griseus</i>	bluntnose sixgill shark		x	x		x	x	x						
<i>Hexanchus nakamurai</i>	bigeye sixgill shark	x												
<i>Notorynchus cepedianus</i>	broadnose sevengill shark								x	x	x	x		
Order Squaliformes, Family Echinorhinidae: bramble sharks														
<i>Echinorhinus brucus</i>	bramble shark	x	x											
<i>Echinorhinus cookei</i>	prickly shark									x				
Order Squaliformes, Family Squalidae: dogfish sharks														
<i>Cirrhigaleus asper</i>	roughskin dogfish		x	x	x	x	x	x						
<i>Squalus acanthias</i>	spiny dogfish, spurdog	x	x	x	x									

Appendix Table C-4 Geographic distribution of elasmobranch species within MMS planning areas and regions of Alaska.
(continued)

Species	Common Name	Geographic Region ^a													
		North Atlantic	Mid Atlantic	South Atlantic	Straits of Florida	Eastern Gulf of Mexico	Central Gulf of Mexico	Western Gulf of Mexico	Southern California	Central California	Northern California	Washington/Oregon	Alaska (Aleutian Islands)	Alaska (Frontier)	Alaska (Northslope)
<i>Squalus cubensis</i>	Cuban dogfish		x	x	x	x	x	x							
Order Squaliformes, Family Etmopteridae: lantern sharks															
<i>Centroscyllium fabricii</i>	black dogfish	x	x			x	x	x							
<i>Etmopterus bigelowi</i>	blurred lantern shark					x	x	x							
<i>Etmopterus gracilispinis</i>	broadband lantern shark		x	x											
Order Squaliformes, Family Somniosidae: sleeper sharks															
<i>Centroscygnus coelepis</i>	Portuguese shark	x	x												
<i>Somniosus microcephalus</i>	Greenland shark	x													
<i>Somniosus pacificus</i>	Pacific sleeper shark								x	x	x	x	x	x	
Order Squaliformes, Family Dalatiidae: kitefin sharks															
<i>Dalatias licha</i>	kitefin shark	x				x	x	x							
Order Squantiformes, Family Squatinidae: angel sharks															
<i>Squatina californica</i>	Pacific angel shark								x	x	x	x	x		

Appendix Table C-4 Geographic distribution of elasmobranch species within MMS planning areas and regions of Alaska.
(continued)

Species	Common Name	Geographic Region ^a													
		North Atlantic	Mid Atlantic	South Atlantic	Straits of Florida	Eastern Gulf of Mexico	Central Gulf of Mexico	Western Gulf of Mexico	Southern California	Central California	Northern California	Washington/Oregon	Alaska (Aleutian Islands)	Alaska (Frontier)	Alaska (Northslope)
<i>Squatina dumeril</i>	Atlantic angel shark	x	x	x	x	x	x	x							
Order Heterodontiformes, Family Heterodontidae: bullhead sharks															
<i>Heterodontus francisci</i>	horn shark					x	x	x	x	x					
Order Orectolobiformes, Family Ginglymostomatidae: nurse sharks															
<i>Ginglymostoma cirratum</i>	nurse shark	x	x	x	x	x	x	x							
Order Orectolobiformes, Family Rhincodontidae: whale sharks															
<i>Rhincodon typus</i>	whale shark	x	x	x	x	x	x	x							
Order Lamniformes, Family Mitsukurinidae: goblin sharks															
<i>Mitsukurina owstoni</i>	goblin shark								x						
Order Lamniformes, Family Odontaspidae: sand tigers															
<i>Carcharias taurus</i>	sand tiger	x	x	x	x	x	x	x							
<i>Odontaspis ferox</i>	ragged-tooth shark								x						
<i>Odontaspis noronhai</i>	bigeye sand tiger			x	x	x	x	x							

Appendix Table C-4 Geographic distribution of elasmobranch species within MMS planning areas and regions of Alaska.
(continued)

Species	Common Name	Geographic Region ^a												
		North Atlantic	Mid Atlantic	South Atlantic	Straits of Florida	Eastern Gulf of Mexico	Central Gulf of Mexico	Western Gulf of Mexico	Southern California	Central California	Northern California	Washington/Oregon	Alaska (Aleutian Islands)	Alaska (Frontier)
Order Lamniformes, Family Megachasmidae: megamouth sharks														
<i>Megachasma pelagios</i>	megamouth shark								x					
Order Lamniformes, Family Alopiidae: thresher sharks														
<i>Alopias superciliosus</i>	bigeye thresher		x	x	x									
<i>Alopias vulpinus</i>	thresher shark	x	x	x	x	x	x	x	x	x	x	x		
Order Lamniformes, Family Cetorhinidae: basking sharks														
<i>Cetorhinus maximus</i>	basking shark	x	x	x	x				x	x	x	x	x	
Order Lamniformes, Family Lamnidae: mackerel sharks														
<i>Carcharodon carcharias</i>	white shark	x	x	x	x	x	x	x	x	x	x	x	x	
<i>Isurus oxyrinchus</i>	shortfin mako	x	x	x	x				x			x		
<i>Isurus paucus</i>	longfin mako	x	x	x	x									
<i>Lamna ditropis</i>	salmon shark								x	x	x	x	x	x
<i>Lamna nasus</i>	porbeagle	x	x											
Order Carcharhiniformes, Family Scyliorhinidae: cat sharks														
<i>Apristurus brunneus</i>	brown cat shark								x	x	x	x		
<i>Cephaloscyllium ventriosum</i>	swell shark								x	x				

Appendix Table C-4 Geographic distribution of elasmobranch species within MMS planning areas and regions of Alaska.
(continued)

Species	Common Name	Geographic Region ^a													
		North Atlantic	Mid Atlantic	South Atlantic	Straits of Florida	Eastern Gulf of Mexico	Central Gulf of Mexico	Western Gulf of Mexico	Southern California	Central California	Northern California	Washington/Oregon	Alaska (Aleutian Islands)	Alaska (Frontier)	Alaska (Northslope)
<i>Galeus arae</i>	marbled cat shark		X	X	X	X	X	X							
<i>Parmaturus xaniurus</i>	filetail cat shark									X	X	X			
<i>Scyliorhinus retifer</i>	chain dogfish	X	X	X	X	X	X	X							
Order Carcharhiniformes, Family Pseudotriakidae: false cat sharks															
<i>Pseudotriakis microdon</i>	false cat shark		X												
Order Carcharhiniformes, Family Triakidae: hound sharks															
<i>Galeorhinus galeus</i>	tope									X	X	X	X		
<i>Mustelus californicus</i>	gray smoothhound										X	X			
<i>Mustelus canis</i>	smooth dogfish	X	X	X	X	X	X								
<i>Mustelus henlei</i>	brown smoothhound								X	X	X				
<i>Mustelus lunulatus</i>	sicklefin smoothhound								X						
<i>Mustelus norrisi</i>	Florida smoothhound				X	X	X	X							

Appendix Table C-4 Geographic distribution of elasmobranch species within MMS planning areas and regions of Alaska.
(continued)

Species	Common Name	Geographic Region ^a													
		North Atlantic	Mid Atlantic	South Atlantic	Straits of Florida	Eastern Gulf of Mexico	Central Gulf of Mexico	Western Gulf of Mexico	Southern California	Central California	Northern California	Washington/Oregon	Alaska (Aleutian Islands)	Alaska (Frontier)	Alaska (Northslope)
<i>Mustelus sinusmexicanus</i>	Gulf smoothhound					X	X	X							
<i>Triakis semifasciata</i>	leopard shark								X	X	X	X			
Order Carcharhiniformes, Family Carcharhinidae: requiem sharks															
<i>Carcharhinus acronotus</i>	blacknose shark		X	X	X										
<i>Carcharhinus altimus</i>	bignose shark				X										
<i>Carcharhinus brachyurus</i>	narrowtooth shark					X	X	X	X						
<i>Carcharhinus brevipinna</i>	spinner shark		X	X	X	X	X	X							
<i>Carcharhinus falciformis</i>	silky shark	X	X	X	X	X	X	X							
<i>Carcharhinus galapagensis</i>	Galapagos shark			X											
<i>Carcharhinus isodon</i>	finetooth shark		X	X	X										
<i>Carcharhinus leucas</i>	bull shark	X	X	X	X	X	X	X							
<i>Carcharhinus limbatus</i>	blacktip shark	X	X	X	X	X	X	X							

Appendix Table C-4 Geographic distribution of elasmobranch species within MMS planning areas and regions of Alaska.
(continued)

Species	Common Name	Geographic Region ^a													
		North Atlantic	Mid Atlantic	South Atlantic	Straits of Florida	Eastern Gulf of Mexico	Central Gulf of Mexico	Western Gulf of Mexico	Southern California	Central California	Northern California	Washington/Oregon	Alaska (Aleutian Islands)	Alaska (Frontier)	Alaska (Northslope)
<i>Carcharhinus longimanus</i>	oceanic whitetip shark	x	x	x	x	x	x	x							
<i>Carcharhinus obscurus</i>	dusky shark	x	x	x	x				x						
<i>Carcharhinus perezii</i>	reef shark				x	x	x	x							
<i>Carcharhinus plumbeus</i>	sandbar shark	x	x	x	x	x	x	x							
<i>Carcharhinus porosus</i>	smalltail shark					x	x	x							
<i>Carcharhinus signatus</i>	night shark		x	x	x										
<i>Galeocerdo cuvier</i>	tiger shark	x	x	x	x	x	x	x							
<i>Negaprion brevirostris</i>	lemon shark		x	x	x	x	x	x							
<i>Prionace glauca</i>	blue shark					x	x	x	x	x	x	x	x		
<i>Rhizoprionodon longurio</i>	Pacific sharpnose shark								x						
<i>Rhizoprionodon terraenovae</i>	Atlantic sharpnose shark	x	x	x	x	x	x	x							
Order Carcharhiniformes, Family Sphyrnidae: hammerhead sharks															

Appendix Table C-4 Geographic distribution of elasmobranch species within MMS planning areas and regions of Alaska.
(continued)

Species	Common Name	Geographic Region ^a													
		North Atlantic	Mid Atlantic	South Atlantic	Straits of Florida	Eastern Gulf of Mexico	Central Gulf of Mexico	Western Gulf of Mexico	Southern California	Central California	Northern California	Washington/Oregon	Alaska (Aleutian Islands)	Alaska (Frontier)	Alaska (Northslope)
<i>Sphyrna lewini</i>	scalloped hammerhead		X	X	X	X	X	X	X						
<i>Sphyrna mokarran</i>	great hammerhead		X	X	X										
<i>Sphyrna tiburo</i>	bonnethead	X	X	X	X				X						
<i>Sphyrna zygaena</i>	smooth hammerhead	X	X	X	X				X	X	X				
Order Torpediniformes, Family Narcinidae: electric rays															
<i>Narcine bancroftii</i>	lesser electric ray		X	X	X	X	X	X							
Order Torpediniformes, Family Torpedinidae: torpedo electric rays															
<i>Torpedo californica</i>	Pacific electric ray								X	X	X	X			
<i>Torpedo nobiliana</i>	Atlantic torpedo	X	X	X	X										
Order Pristiformes, Family Pristidae: sawfishes															
<i>Pristis pectinata</i>	smalltooth sawfish		X	X	X	X	X	X							
<i>Pristis pristis</i>	largetooth sawfish					X	X	X							

Appendix Table C-4 Geographic distribution of elasmobranch species within MMS planning areas and regions of Alaska.
(continued)

Species	Common Name	Geographic Region ^a												
		North Atlantic	Mid Atlantic	South Atlantic	Straits of Florida	Eastern Gulf of Mexico	Central Gulf of Mexico	Western Gulf of Mexico	Southern California	Central California	Northern California	Washington/Oregon	Alaska (Aleutian Islands)	Alaska (Frontier)
Order Rajiformes, Family Rhinobatidae: guitarfishes														
<i>Rhinobatos lentiginosus</i>	Atlantic guitarfish		x	x	x	x	x	x						
<i>Rhinobatos productus</i>	shovelnose guitarfish								x	x				
<i>Zapteryx exasperata</i>	banded guitarfish								x					
Order Rajiformes, Family Platyrhynidae: thornbacks														
<i>Platyrhinoideis triseriata</i>	thornback								x	x				
Order Rajiformes, Family Rajidae: skates														
<i>Amblyraja radiata</i>	thorny skate	x	x	x										
<i>Bathyraja aleutica</i>	Aleutian skate											x		
<i>Bathyraja interrupta</i>	sandpaper skate								x	x	x	x	x	
<i>Bathyraja lindbergi</i>	Commander skate											x	x	
<i>Bathyraja maculata</i>	whiteblotched skate											x	x	
<i>Bathyraja parmifera</i>	Alaska skate											x	x	
<i>Bathyraja spinicauda</i>	spinytail skate	x												

Appendix Table C-4 Geographic distribution of elasmobranch species within MMS planning areas and regions of Alaska.
(continued)

Species	Common Name	Geographic Region ^a													
		North Atlantic	Mid Atlantic	South Atlantic	Straits of Florida	Eastern Gulf of Mexico	Central Gulf of Mexico	Western Gulf of Mexico	Southern California	Central California	Northern California	Washington/Oregon	Alaska (Aleutian Islands)	Alaska (Frontier)	Alaska (Northslope)
<i>Bathyraja taranetzi</i>	mud skate												X		
<i>Bathyraja violacea</i>	Okhotsk skate												X		
<i>Dipturus bullisi</i>	lozenge skate				X										
<i>Dipturus laevis</i>	barndoor skate	X	X												
<i>Dipturus olsenii</i>	spreadfin skate					X	X	X							
<i>Leucoraja erinacea</i>	little skate	X	X												
<i>Leucoraja garmani</i>	rosette skate	X	X	X	X										
<i>Leucoraja lentiginosa</i>	freckled skate		X	X	X	X	X	X							
<i>Leucoraja ocellata</i>	winter skate	X	X												
<i>Leucoraja virginica</i>	Virginia skate	X													
<i>Malacoraja senta</i>	smooth skate	X													
<i>Raja ackleyi</i>	ocellate skate					X	X	X							
<i>Raja binoculata</i>	big skate								X	X	X	X	X		
<i>Raja eglanteria</i>	clearnose skate	X	X												
<i>Raja inornata</i>	California skate								X	X	X	X			
<i>Raja rhina</i>	longnose skate								X	X	X	X	X		
<i>Raja stellulata</i>	starry skate								X	X	X	X	X		
<i>Raja texana</i>	roundel skate					X	X	X							
Order Myliobatiformes, Family Dasyatidae: whiptail stingrays															

Appendix Table C-4 Geographic distribution of elasmobranch species within MMS planning areas and regions of Alaska.
(continued)

Species	Common Name	Geographic Region ^a													
		North Atlantic	Mid Atlantic	South Atlantic	Straits of Florida	Eastern Gulf of Mexico	Central Gulf of Mexico	Western Gulf of Mexico	Southern California	Central California	Northern California	Washington/Oregon	Alaska (Aleutian Islands)	Alaska (Frontier)	Alaska (Northslope)
<i>Dasyatis Americana</i>	southern stingray		X	X	X	X	X	X							
<i>Dasyatis centroura</i>	rougtail stingray	X	X	X	X			X							
<i>Dasyatis dipterura</i>	diamond stingray								X						
<i>Dasyatis sabina</i>	Atlantic stingray		X	X	X	X	X	X							
<i>Dasyatis say</i>	bluntnose stingray		X	X	X	X	X	X							
<i>Pteroplatytrygon violacea</i>	pelagic stingray								X	X	X				
Order Myliobatiformes, Family Urolophidae: round stingrays															
<i>Urobatis halleri</i>	round stingray								X	X	X				
<i>Urobatis jamaicensis</i>	yellow stingray		X	X	X										
Order Myliobatiformes, Family Gymnuridae: butterfly rays															
<i>Gymnura altavela</i>	spiny butterfly ray	X	X	X	X	X	X	X							
<i>Gymnura marmorata</i>	California butterfly ray								X	X	X				
<i>Gymnura micrura</i>	smooth butterfly ray		X	X	X	X	X	X							

Appendix Table C-4 Geographic distribution of elasmobranch species within MMS planning areas and regions of Alaska.
(continued)

Species	Common Name	Geographic Region ^a													
		North Atlantic	Mid Atlantic	South Atlantic	Straits of Florida	Eastern Gulf of Mexico	Central Gulf of Mexico	Western Gulf of Mexico	Southern California	Central California	Northern California	Washington/Oregon	Alaska (Aleutian Islands)	Alaska (Frontier)	Alaska (Northslope)
Order Myliobatiformes, Family Myliobatidae: eagle rays															
<i>Aetobatus narinari</i>	spotted eagle ray		x	x	x	x	x	x							
<i>Myliobatis californica</i>	bat ray								x	x	x	x			
<i>Myliobatis freminvillei</i>	bullnose ray	x	x	x	x										
<i>Myliobatis goodei</i>	southern eagle ray			x	x										
Order Myliobatiformes, Family Rhinopteridae: cownose rays															
<i>Rhinoptera bonasus</i>	cownose ray	x	x	x	x										
Order Myliobatiformes, Family Mobulidae: mantas															
<i>Manta birostris</i>	giant manta	x	x			x	x	x							
<i>Mobula hypostoma</i>	devil ray		x	x	x	x	x	x							
<i>Mobula japanica</i>	spinetail mobula								x	x	x	x			
<i>Mobula tarapacana</i>	sicklefin devil ray							x							

^a see Figure 1.0-1; Citations for range data provided in Appendix Table C-3

Appendix Table C-5

Worldwide listing of marine fish species (non-elasmobranch) for which information on sensitivity to electric or magnetic fields has been suggested or studied, along with related species from US waters and any federally listed threatened (T) or endangered (E) species.

Species ^a	Common Name	Status ^b	US? ^c	Evidence Taxon	Sensitivity ^d	Sensory Range	Evidence Basis	Citation
Superclass Agnatha, Class Cephalaspidomorphi, Order Petromyzontiformes, Family Petromyzontidae: lampreys								
<i>Lampetra ayresii</i> ^e	river lamprey		US	<i>L. fluviatilis</i>	E	n/a	n/a	
<i>Lampetra camtschatica</i>	Arctic lamprey		US	<i>L. fluviatilis</i>	E	n/a	n/a	
<i>Lampetra fluviatilis</i>	European river lamprey		Not in US	direct	E	10–30 μV/cm	physiological: neural response	Akoev and Muraveiko 1984
<i>Lampetra fluviatilis</i>	European river lamprey		Not in US	direct	E	n/a	anatomical: neural anatomy	Fritzsche et al. 1984
<i>Lampetra fluviatilis</i>	European river lamprey		Not in US	direct	E	0.1 to 20 μV/cm	physiological: neural response	Muraveiko 1984
<i>Lampetra fluviatilis</i>	European river lamprey		Not in US	<i>L. fluviatilis</i>	E	0.1 to 20 μV/cm	physiological/ anatomical	
<i>Lampetra tridentata</i>	Pacific lamprey		US	direct	E	0.1 μV/cm to 20 μV/cm	physiological: neural response	Bodznick and Northcutt 1981
<i>Lampetra tridentata</i>	Pacific lamprey		US	<i>L. tridentata</i>	E	0.1 μV/cm to 20 μV/cm	physiological	
<i>Petromyzon marinus</i>	sea lamprey		US	direct	E	1 to 10 mV/cm (frequency ≤ 1 Hz)	physiological: neural response	Bodznick and Preston 1983
<i>Petromyzon marinus</i>	sea lamprey		US	direct	E	-0.1 to -30.0 μV/cm	behavioral/ physiological: neuroendocrine response	Chung-Davidson et al. 2004
<i>Petromyzon marinus</i>	sea lamprey		US	direct	E	n/a	behavioral/ physiological: neuroendocrine response	Chung-Davidson et al. 2008
<i>Petromyzon marinus</i>	sea lamprey		US	direct	E	n/a	anatomical: neural anatomy	Kishida et al. 1988
<i>Petromyzon marinus</i>	sea lamprey		US	direct	E	n/a	anatomical: neural anatomy	Koyama et al. 1993
<i>Petromyzon marinus</i>	sea lamprey		US	<i>P. marinus</i>	E	1 to 10 mV/cm	physiological/ behavioral/ anatomical	
Class Chondrichthyes, Subclass Holocephali, Order Chimaeriformes, Family Chimaeridae: shortnose chimaeras								
<i>Hydrolagus collieri</i>	spotted ratfish		US	direct	E	n/a	anatomical/ behavioral/ physiological	Fields 1982
<i>Hydrolagus collieri</i>	spotted ratfish		US	direct		<0.2 μV/cm, DC or 5 Hz	behavioral: conditioned response	Fields and Lange 1980
<i>Hydrolagus collieri</i>	spotted ratfish		US	direct	E	0.2 μV/cm, 5 Hz	physiological: neural response; no response to DC fields	Fields et al. 1993

Appendix Table C-5 Worldwide listing of marine fish species (non-elasmobranch) for which information on sensitivity to electric or magnetic fields has been suggested or studied, along with related species from US waters and any federally listed threatened (T) or endangered (E) species. (continued)

Species ^a	Common Name	Status ^b	US? ^c	Evidence Taxon	Sensitivity ^d	Sensory Range	Evidence Basis	Citation
<i>Hydrolagus colliei</i>	spotted ratfish		US	<i>H. colliei</i>	E	0.2 μV/cm, 5 Hz	physiological/ behavioral/ anatomical	
Class Actinopterygii: ray-finned fishes								
Class Actinopterygii, Subclass Chondrostei, Order Acipenseriformes, Family Acipenseridae: sturgeons								
<i>Acipenser brevirostrum</i>	shortnose sturgeon	E	US	<i>A. gueldenstaedtii</i>	E	n/a	n/a	
<i>Acipenser gueldenstaedtii</i>	Russian Sturgeon		Not in US	direct	E	0.2-6 mV/cm, 1.0-50 Hz	behavioral: feeding response, orientation; escape response at ≥0.6 mV/cm, at 50 Hz	Basov 1999
<i>Acipenser gueldenstaedtii</i>	Russian Sturgeon		Not in US	direct	M	n/a	observational/ theoretical: distribution modeling	Gertseva and Gertsev 2002
<i>Acipenser gueldenstaedtii</i>	Russian Sturgeon		Not in US	<i>A. gueldenstaedtii</i>	E/M	0.2-6 mV/cm, 1.0-50 Hz	behavioral/ observational/ theoretical	
<i>Acipenser medirostris</i>	green sturgeon	T	US	<i>A. gueldenstaedtii</i>	E	n/a	n/a	
<i>Acipenser oxyrinchus</i>	Atlantic sturgeon		US	<i>A. gueldenstaedtii</i>	E	n/a	n/a	
<i>Acipenser oxyrinchus desotoi</i>	Gulf sturgeon	T	US	<i>A. gueldenstaedtii</i>	E	n/a	n/a	
<i>Acipenser ruthenus</i>	Sterlet		Not in US	direct	E	0.2-6 mV/cm, 1.0-50 Hz	behavioral: feeding response, orientation; escape response at ≥0.6 mV/cm, at 50 Hz	Basov 1999
<i>Acipenser transmontanus</i>	white sturgeon		US	<i>A. gueldenstaedtii</i>	E	n/a	n/a	
<i>Scaphirhynchus platyrhynchus</i>	shovelnose sturgeon		Not in US	direct	E	<0.2 μV/cm at 4 cm	physiological: neural response	Teeter et al. 1980

Appendix Table C-5 Worldwide listing of marine fish species (non-elasmobranch) for which information on sensitivity to electric or magnetic fields has been suggested or studied, along with related species from US waters and any federally listed threatened (T) or endangered (E) species. (continued)

Species ^a	Common Name	Status ^b	US? ^c	Evidence Taxon	Sensitivity ^d	Sensory Range	Evidence Basis	Citation
Class Actinopterygii, Subclass Neopterygii, Infraclass Teleostei: teleost fishes								
Order Anguilliformes, Family Anguillidae: freshwater eels								
<i>Anguilla anguilla</i>	European eel		Not in US	direct	E	1x10 ⁻⁶ A/cm ²	physiological: conditioned response	Vriens and Bretschneider 1979
<i>Anguilla anguilla</i>	European eel		Not in US	direct	M	geomagnetic field	behavioral: orientation	Tesch 1974
<i>Anguilla anguilla</i>	European eel		Not in US	direct	M	geomagnetic field	behavioral: orientation	Karlsson 1985
<i>Anguilla anguilla</i>	European eel		Not in US	direct	E	0.4-0.6 mV/cm	physiological: conditioned heart rate response	Enger et al. 1976
<i>Anguilla anguilla</i>	European eel		Not in US	direct	E	0.97 mV/cm to 19 mV/cm	physiological	Berge 1979
<i>Anguilla anguilla</i>	European eel		Not in US	direct	M	n/a	anatomical: magnetic material in body	Moore and Riley 2009
<i>Anguilla anguilla</i>	European eel		Not in US	<i>A. anguilla</i>	E/M	0.4 mV/cm to 19 mV/cm; geomagnetic field	physiological/ behavioral/ anatomical	
<i>Anguilla rostrata</i>	American eel		US	direct	E	0.167x10 ⁻² μA/cm ²	physiological: conditioned heart rate response	Rommel and McCleave 1972
<i>Anguilla rostrata</i>	American eel		US	direct	M	geomagnetic field	behavioral: orientation	Tesch 1974
<i>Anguilla rostrata</i>	American eel		US	direct	none	n/a	none: no response in elvers to manipulation of geomagnetic field	Zimmerman and McCleave 1975
<i>Anguilla rostrata</i>	American eel		US	direct	E	0.067 mV/cm	physiological: conditioned response	Rommel and McCleave 1973b
<i>Anguilla rostrata</i>	American eel		US	direct	E	10 ⁻² μA cm ⁻² to 10 ² μA cm ⁻²	behavioral: orientation	McCleave and Power 1978
<i>Anguilla rostrata</i>	American eel		US	<i>A. rostrata</i>	E/M	geomagnetic field; 0.067 mV/cm	physiological/ behavioral/ anatomical	
<i>Anguilla japonica</i>	Japanese eel		Not in US	direct	M	12,663 to 192,473 nT	physiological: conditioned response	Nishi and Kawamura 2005
<i>Anguilla japonica</i>	Japanese eel		Not in US	direct	none	n/a	none: no conditioned heart rate response to geomagnetic field in anosmic eels	Nishi et al. 2005
<i>Anguilla japonica</i>	Japanese eel		Not in US	direct	M	geomagnetic field	physiological: conditioned response	Nishi et al. 2004

Appendix Table C-5 Worldwide listing of marine fish species (non-elasmobranch) for which information on sensitivity to electric or magnetic fields has been suggested or studied, along with related species from US waters and any federally listed threatened (T) or endangered (E) species. (continued)

Species ^a	Common Name	Status ^b	US? ^c	Evidence Taxon	Sensitivity ^d	Sensory Range	Evidence Basis	Citation
<i>Anguilla japonica</i>	Japanese eel		Not in US	<i>A. japonica</i>	M	geomagnetic field; 12,663 to 192,473 nT	physiological	
<i>Order Siluriformes, Family Clariidae: labyrinth catfishes</i>								
<i>Clarias batrachus</i>	walking catfish		Not in US	direct	M	n/a	physiological: biological effects; changes to liver cells from magnet exposure	Garg et al. 1995
<i>Clarias batrachus</i>	walking catfish		US	<i>C. batrachus</i>	M	n/a	physiological	
Order Siluriformes, Family Ariidae: sea catfishes								
<i>Ariidae</i>				Siluriformes	E	n/a	physiological/ anatomical	Collin and Whitehead 2004
<i>Bagre marinus</i>	gafftopsail catfish		US	Siluriformes	E	n/a	n/a	
<i>Bagre panamensis</i>	chihuil		US	Siluriformes	E	n/a	n/a	
Order Salmoniformes, Family Osmeridae: smelts								
<i>Thaleichthys pacificus</i>	eulachon	T	US	Salmonidae	?	n/a	n/a	
<i>Salmonidae</i>	salmon		US	direct	M?	n/a	anatomical: magnetic material in body less than bees, pigeons, or dolphins	Ueda et al. 1986
<i>Salmonidae</i>	salmon		US	direct	M?	n/a	theoretical	Lohmann et al. 2008a
Order Salmoniformes, Family Salmonidae: trouts and salmon								
<i>Coregonus clupeaformis</i>	lake whitefish		US	<i>O. mykiss</i>	M?	n/a	n/a	
<i>Coregonus huntsmani</i>	Atlantic whitefish		US	<i>O. mykiss</i>	M?	n/a	n/a	
<i>Oncorhynchus clarkii</i>	cutthroat trout		US	<i>O. mykiss</i>	M?	n/a	n/a	
<i>Oncorhynchus gorbuscha</i>	pink salmon		US	<i>O. mykiss</i>	M?	n/a	n/a	
<i>Oncorhynchus keta</i>	chum salmon	T	US	direct	M	n/a	anatomical: magnetic material in body	Yano and Aoyagi 2008
<i>Oncorhynchus keta</i>	chum salmon	T	US	direct	M?	geomagnetic field	behavioral: orientation	Quinn and Groot 1983
<i>Oncorhynchus keta</i>	chum salmon	T	US	direct	none	n/a	none: magnets attached to head caused no effect on swim direction	Yano et al. 1997

Appendix Table C-5 Worldwide listing of marine fish species (non-elasmobranch) for which information on sensitivity to electric or magnetic fields has been suggested or studied, along with related species from US waters and any federally listed threatened (T) or endangered (E) species. (continued)

Species ^a	Common Name	Status ^b	US? ^c	Evidence Taxon	Sensitivity ^d	Sensory Range	Evidence Basis	Citation
<i>Oncorhynchus keta</i>	chum salmon	T	US	<i>O. keta</i>	M	geomagnetic field	behavioral/ anatomical	
<i>Oncorhynchus kisutch</i>	coho salmon	E/T	US	<i>O. mykiss</i>	M?	n/a	n/a	
<i>Oncorhynchus mykiss</i>	rainbow trout (steelhead)	E/T	US	direct	M	peak intensity of 75 μ T	behavioral: learned response	Haugh and Walker 1998
<i>Oncorhynchus mykiss</i>	rainbow trout (steelhead)	E/T	US	direct	M	0.5-4.0 mT	behavioral: spatial orientation of fish embryos	Tanski et al. 2005
<i>Oncorhynchus mykiss</i>	rainbow trout (steelhead)	E/T	US	direct	M	50 μ T changes to field	physiological: neural response	Walker et al. 1997
<i>Oncorhynchus mykiss</i>	rainbow trout (steelhead)	E/T	US	direct	M	n/a	physiological: magnetic fields increased permeability of eggs to water	Sadowski et al. 2007
<i>Oncorhynchus mykiss</i>	rainbow trout (steelhead)	E/T	US	direct	M	n/a	anatomical: magnetite crystals	Diebel et al. 2000
<i>Oncorhynchus mykiss</i>	rainbow trout (steelhead)	E/T	US	direct	M	0.5 to > 4 mT	physiological: changes to embryo orientation (0.5 to 1 mT) and development (> 4 mT)	Formicki and Winnicki 1998
<i>Oncorhynchus mykiss</i>	steelhead trout	E/T	US	<i>O. mykiss</i>	M	50 μ T changes to field	physiological/ behavioral/ anatomical	
<i>Oncorhynchus nerka</i>	sockeye salmon	E/T	US	direct	M	n/a	anatomical: magnetite crystals	Walker et al. 1988
<i>Oncorhynchus nerka</i>	sockeye salmon	E/T	US	direct	M	geomagnetic field	behavioral: orientation	Quinn and Brannon 1982
<i>Oncorhynchus nerka</i>	sockeye salmon	E/T	US	direct	M	geomagnetic field	behavioral: orientation	Quinn et al. 1981
<i>Oncorhynchus nerka</i>	sockeye salmon	E/T	US	direct	M	geomagnetic field	behavioral: orientation	Quinn 1980
<i>Oncorhynchus nerka</i>	sockeye salmon	E/T	US	direct	M	n/a	anatomical: magnetite crystals	Mann et al. 1988
<i>Oncorhynchus nerka</i>	sockeye salmon	E/T	US	<i>O. nerka</i>	M	geomagnetic field	behavioral/ anatomical	
<i>Oncorhynchus tshawytscha</i>	Chinook salmon	E/T	US	direct	M	geomagnetic field	behavioral: delayed orientation response	Taylor 1986
<i>Oncorhynchus tshawytscha</i>	Chinook salmon	E/T	US	<i>O. tshawytscha</i>	M	geomagnetic field	behavioral	

Appendix Table C-5 Worldwide listing of marine fish species (non-elasmobranch) for which information on sensitivity to electric or magnetic fields has been suggested or studied, along with related species from US waters and any federally listed threatened (T) or endangered (E) species. (continued)

Species ^a	Common Name	Status ^b	US? ^c	Evidence Taxon	Sensitivity ^d	Sensory Range	Evidence Basis	Citation
<i>Salmo salar</i>	Atlantic salmon	E	US	direct	M	0.5-4.0 mT	behavioral: spatial orientation of fish embryos	Tanski et al. 2005
<i>Salmo salar</i>	Atlantic salmon	E	US	direct	M	n/a	physiological: magnetic fields increased permeability of eggs to water	Sadowski et al. 2007
<i>Salmo salar</i>	Atlantic salmon	E	US	direct	E	0.6 mV/cm	physiological: conditioned response	Rommel and McCleave 1973
<i>Salmo salar</i>	Atlantic salmon	E	US	direct	M	n/a	anatomical: magnetite in body	Moore et al. 1990
<i>Salmo salar</i>	Atlantic salmon	E	US	<i>S. salar</i>	M/E?	0.5-4.0 mT; 0.6 mV/cm	physiological/ behavioral/ anatomical	
<i>Salmo trutta</i>	Brown trout		US	direct	M	0.5-4.0 mT	behavioral: spatial orientation of fish embryos	Tanski et al. 2005
<i>Salmo trutta</i>	Brown trout		US	direct	M	0.5 to > 4 mT	physiological: changes to embryo orientation (0.5 to 1 mT) and development (> 4 mT)	Formicki and Winnicki 1998
<i>Salmo trutta</i>	Brown trout		US	direct	M	0.15 – 4.2 mT	behavioral: attraction	Formicki et al. 2004
<i>Salmo trutta</i>	Brown trout		US	direct	M	n/a	physiological: magnetic fields increased permeability of eggs to water	Sadowski et al. 2007
<i>Salmo trutta</i>	brown trout		US	<i>S. trutta</i>	M	0.15 – 4.2 mT	physiological/ behavioral	
<i>Salvelinus alpinus</i>	Arctic char		US	<i>O. mykiss</i>	M?	n/a	n/a	
<i>Salvelinus confluentus</i>	bull trout		US	<i>O. mykiss</i>	M?	n/a	n/a	
<i>Salvelinus fontinalis</i>	brook trout		US	<i>O. mykiss</i>	M?	n/a	n/a	
<i>Salvelinus malma</i>	Dolly Varden		US	<i>O. mykiss</i>	M?	n/a	n/a	
Order Gadiformes, Family Gadidae: cods								
<i>Arctogadus borisovi</i>	toothed cod		US	<i>G. morhua</i>	E?	n/a	n/a	
<i>Arctogadus glacialis</i>	polar cod		US	<i>G. morhua</i>	E?	n/a	n/a	
<i>Boreogadus saida</i>	Arctic cod		US	<i>G. morhua</i>	E?	n/a	n/a	
<i>Brosme brosme</i>	cusk		US	<i>G. morhua</i>	E?	n/a	n/a	
<i>Eleginus gracilis</i>	saffron cod		US	<i>G. morhua</i>	E?	n/a	n/a	

Appendix Table C-5 Worldwide listing of marine fish species (non-elasmobranch) for which information on sensitivity to electric or magnetic fields has been suggested or studied, along with related species from US waters and any federally listed threatened (T) or endangered (E) species. (continued)

Species ^a	Common Name	Status ^b	US? ^c	Evidence Taxon	Sensitivity ^d	Sensory Range	Evidence Basis	Citation
<i>Gadus macrocephalus</i>	Pacific cod		US	<i>G. morhua</i>	E?	n/a	n/a	
<i>Gadus morhua</i>	Atlantic cod		US	direct	E	2 $\mu\text{A}/\text{cm}^2$	behavioral	Regnart 1931
<i>Gadus morhua</i>	Atlantic cod		US	<i>G. morhua</i>	E?	2 $\mu\text{A}/\text{cm}^2$	behavioral	
<i>Gadus ogac</i>	Greenland cod		US	<i>G. morhua</i>	E?	n/a	n/a	
<i>Melanogrammus aeglefinus</i>	haddock		US	<i>G. morhua</i>	E?	n/a	n/a	
<i>Microgadus proximus</i>	Pacific tomcod		US	<i>G. morhua</i>	E?	n/a	n/a	
<i>Microgadus tomcod</i>	Atlantic tomcod		US	<i>G. morhua</i>	E?	n/a	n/a	
<i>Micromesistius poutassou</i>	blue whiting		US	<i>G. morhua</i>	E?	n/a	n/a	
<i>Molva molva</i>	European ling		US	<i>G. morhua</i>	E?	n/a	n/a	
<i>Pollachius virens</i>	pollock		US	<i>G. morhua</i>	E?	n/a	n/a	
<i>Theragra chalcogramma</i>	walleye pollock		US	<i>G. morhua</i>	E?	n/a	n/a	
Order Scorpaeniformes, Family Scorpaenidae: scorpionfishes								
<i>Sebastes aleutianus</i>	rougeye rockfish		US	<i>S. inermis</i>	M?	n/a	n/a	
<i>Sebastes alutus</i>	Pacific ocean perch		US	<i>S. inermis</i>	M?	n/a	n/a	
<i>Sebastes atrovirens</i>	kelp rockfish		US	<i>S. inermis</i>	M?	n/a	n/a	
<i>Sebastes auriculatus</i>	brown rockfish		US	<i>S. inermis</i>	M?	n/a	n/a	
<i>Sebastes aurora</i>	aurora rockfish		US	<i>S. inermis</i>	M?	n/a	n/a	
<i>Sebastes babcocki</i>	redbanded rockfish		US	<i>S. inermis</i>	M?	n/a	n/a	
<i>Sebastes borealis</i>	shortraker rockfish		US	<i>S. inermis</i>	M?	n/a	n/a	
<i>Sebastes brevispinis</i>	silvergray rockfish		US	<i>S. inermis</i>	M?	n/a	n/a	
<i>Sebastes carnatus</i>	gopher rockfish		US	<i>S. inermis</i>	M?	n/a	n/a	
<i>Sebastes caurinus</i>	copper rockfish		US	<i>S. inermis</i>	M?	n/a	n/a	
<i>Sebastes chlorostictus</i>	greenspotted rockfish		US	<i>S. inermis</i>	M?	n/a	n/a	
<i>Sebastes chrysomelas</i>	black-and-yellow rockfish		US	<i>S. inermis</i>	M?	n/a	n/a	
<i>Sebastes ciliatus</i>	dusky rockfish		US	<i>S. inermis</i>	M?	n/a	n/a	
<i>Sebastes constellatus</i>	starry rockfish		US	<i>S. inermis</i>	M?	n/a	n/a	
<i>Sebastes crameri</i>	darkblotched rockfish		US	<i>S. inermis</i>	M?	n/a	n/a	
<i>Sebastes dallii</i>	calico rockfish		US	<i>S. inermis</i>	M?	n/a	n/a	
<i>Sebastes diploproa</i>	splitnose rockfish		US	<i>S. inermis</i>	M?	n/a	n/a	

Appendix Table C-5 Worldwide listing of marine fish species (non-elasmobranch) for which information on sensitivity to electric or magnetic fields has been suggested or studied, along with related species from US waters and any federally listed threatened (T) or endangered (E) species. (continued)

Species ^a	Common Name	Status ^b	US? ^c	Evidence Taxon	Sensitivity ^d	Sensory Range	Evidence Basis	Citation
<i>Sebastes elongatus</i>	greenstriped rockfish		US	<i>S. inermis</i>	M?	n/a	n/a	
<i>Sebastes emphaeus</i>	Puget Sound rockfish		US	<i>S. inermis</i>	M?	n/a	n/a	
<i>Sebastes ensifer</i>	swordspine rockfish		US	<i>S. inermis</i>	M?	n/a	n/a	
<i>Sebastes entomelas</i>	widow rockfish		US	<i>S. inermis</i>	M?	n/a	n/a	
<i>Sebastes eos</i>	pink rockfish		US	<i>S. inermis</i>	M?	n/a	n/a	
<i>Sebastes fasciatus</i>	Acadian redfish		US	<i>S. inermis</i>	M?	n/a	n/a	
<i>Sebastes flavidus</i>	yellowtail rockfish		US	<i>S. inermis</i>	M?	n/a	n/a	
<i>Sebastes gilli</i>	bronzespotted rockfish		US	<i>S. inermis</i>	M?	n/a	n/a	
<i>Sebastes glaucus</i>	gray rockfish		US	<i>S. inermis</i>	M?	n/a	n/a	
<i>Sebastes goodei</i>	chilipepper		US	<i>S. inermis</i>	M?	n/a	n/a	
<i>Sebastes helvomaculatus</i>	rosethorn rockfish		US	<i>S. inermis</i>	M?	n/a	n/a	
<i>Sebastes hopkinsi</i>	squarespot rockfish		US	<i>S. inermis</i>	M?	n/a	n/a	
<i>Sebastes inermis</i>	darkbanded rockfish		Not in US	direct	M	n/a	physiological: conditioned response	Nishi and Kawamura 2006
<i>Sebastes jordani</i>	shortbelly rockfish		US	<i>S. inermis</i>	M?	n/a	n/a	
<i>Sebastes lentiginosus</i>	freckled rockfish		US	<i>S. inermis</i>	M?	n/a	n/a	
<i>Sebastes levis</i>	cowcod		US	<i>S. inermis</i>	M?	n/a	n/a	
<i>Sebastes macdonaldi</i>	Mexican rockfish		US	<i>S. inermis</i>	M?	n/a	n/a	
<i>Sebastes maliger</i>	quillback rockfish		US	<i>S. inermis</i>	M?	n/a	n/a	
<i>Sebastes melanops</i>	black rockfish		US	<i>S. inermis</i>	M?	n/a	n/a	
<i>Sebastes melanosema</i>	semaphore rockfish		US	<i>S. inermis</i>	M?	n/a	n/a	
<i>Sebastes melanostomus</i>	blackgill rockfish		US	<i>S. inermis</i>	M?	n/a	n/a	
<i>Sebastes mentella</i>	deepwater redfish		US	<i>S. inermis</i>	M?	n/a	n/a	
<i>Sebastes miniatus</i>	vermillion rockfish		US	<i>S. inermis</i>	M?	n/a	n/a	
<i>Sebastes moseri</i>	whitespotted rockfish		US	<i>S. inermis</i>	M?	n/a	n/a	
<i>Sebastes mystinus</i>	blue rockfish		US	<i>S. inermis</i>	M?	n/a	n/a	
<i>Sebastes nebulosus</i>	China rockfish		US	<i>S. inermis</i>	M?	n/a	n/a	
<i>Sebastes nigrocinctus</i>	tiger rockfish		US	<i>S. inermis</i>	M?	n/a	n/a	
<i>Sebastes norvegicus</i>	golden redfish		US	<i>S. inermis</i>	M?	n/a	n/a	
<i>Sebastes ovalis</i>	speckled rockfish		US	<i>S. inermis</i>	M?	n/a	n/a	
<i>Sebastes paucispinis</i>	bocaccio		US	<i>S. inermis</i>	M?	n/a	n/a	

Appendix Table C-5 Worldwide listing of marine fish species (non-elasmobranch) for which information on sensitivity to electric or magnetic fields has been suggested or studied, along with related species from US waters and any federally listed threatened (T) or endangered (E) species. (continued)

Species ^a	Common Name	Status ^b	US? ^c	Evidence Taxon	Sensitivity ^d	Sensory Range	Evidence Basis	Citation
<i>Sebastes phillipsi</i>	chameleon rockfish		US	<i>S. inermis</i>	M?	n/a	n/a	
<i>Sebastes pinniger</i>	canary rockfish		US	<i>S. inermis</i>	M?	n/a	n/a	
<i>Sebastes polyspinis</i>	northern rockfish		US	<i>S. inermis</i>	M?	n/a	n/a	
<i>Sebastes proriger</i>	redstripe rockfish		US	<i>S. inermis</i>	M?	n/a	n/a	
<i>Sebastes rastrelliger</i>	grass rockfish		US	<i>S. inermis</i>	M?	n/a	n/a	
<i>Sebastes reedi</i>	yellowmouth rockfish		US	<i>S. inermis</i>	M?	n/a	n/a	
<i>Sebastes rosaceus</i>	rosy rockfish		US	<i>S. inermis</i>	M?	n/a	n/a	
<i>Sebastes rosenblatti</i>	greenblotched rockfish		US	<i>S. inermis</i>	M?	n/a	n/a	
<i>Sebastes ruberrimus</i>	yelloweye rockfish		US	<i>S. inermis</i>	M?	n/a	n/a	
<i>Sebastes rubrivinctus</i>	flag rockfish		US	<i>S. inermis</i>	M?	n/a	n/a	
<i>Sebastes rufinanus</i>	dwarf-red rockfish		US	<i>S. inermis</i>	M?	n/a	n/a	
<i>Sebastes rufus</i>	bank rockfish		US	<i>S. inermis</i>	M?	n/a	n/a	
<i>Sebastes saxicola</i>	stripetail rockfish		US	<i>S. inermis</i>	M?	n/a	n/a	
<i>Sebastes semicinctus</i>	halfbanded rockfish		US	<i>S. inermis</i>	M?	n/a	n/a	
<i>Sebastes serranoides</i>	olive rockfish		US	<i>S. inermis</i>	M?	n/a	n/a	
<i>Sebastes serriceps</i>	treefish		US	<i>S. inermis</i>	M?	n/a	n/a	
<i>Sebastes simulator</i>	pinkrose rockfish		US	<i>S. inermis</i>	M?	n/a	n/a	
<i>Sebastes umbrosus</i>	honeycomb rockfish		US	<i>S. inermis</i>	M?	n/a	n/a	
<i>Sebastes variegatus</i>	harlequin rockfish		US	<i>S. inermis</i>	M?	n/a	n/a	
<i>Sebastes wilsoni</i>	pygmy rockfish		US	<i>S. inermis</i>	M?	n/a	n/a	
<i>Sebastes zacentrus</i>	sharpchin rockfish		US	<i>S. inermis</i>	M?	n/a	n/a	
Order Perciformes, Family Haemulidae: grunts								
<i>Haemulon album</i>	margate		US	<i>H. plumierii</i>	M?	n/a	n/a	
<i>Haemulon aurolineatum</i>	tomtate		US	<i>H. plumierii</i>	M?	n/a	n/a	
<i>Haemulon carbonarium</i>	caesar grunt		US	<i>H. plumierii</i>	M?	n/a	n/a	
<i>Haemulon chrysargyreum</i>	smallmouth grunt		US	<i>H. plumierii</i>	M?	n/a	n/a	
<i>Haemulon flaviguttatum</i>	Cortez grunt		US	<i>H. plumierii</i>	M?	n/a	n/a	
<i>Haemulon flavolineatum</i>	French grunt		US	<i>H. plumierii</i>	M?	n/a	n/a	

Appendix Table C-5 Worldwide listing of marine fish species (non-elasmobranch) for which information on sensitivity to electric or magnetic fields has been suggested or studied, along with related species from US waters and any federally listed threatened (T) or endangered (E) species. (continued)

Species ^a	Common Name	Status ^b	US? ^c	Evidence Taxon	Sensitivity ^d	Sensory Range	Evidence Basis	Citation
<i>Haemulon macrostomum</i>	Spanish grunt		US	<i>H. plumieri</i>	M?	n/a	n/a	
<i>Haemulon melanurum</i>	cottonwick		US	<i>H. plumieri</i>	M?	n/a	n/a	
<i>Haemulon parra</i>	sailors choice		US	<i>H. plumieri</i>	M?	n/a	n/a	
<i>Haemulon plumieri</i>	white grunt		US	direct	M?	geomagnetic field	behavioral: swim direction	Quinn and Ogden 1984
<i>Haemulon plumieri</i>	white grunt		US	<i>H. plumieri</i>	M?	geomagnetic field	behavioral	
<i>Haemulon sciurus</i>	bluestriped grunt		US	<i>H. plumieri</i>	M?	n/a	n/a	
<i>Haemulon striatum</i>	striped grunt		US	<i>H. plumieri</i>	M?	n/a	n/a	
Order Perciformes, Family Scombridae: mackerels								
<i>Acanthocybium solandri</i>	wahoo		US	<i>T. albacares</i>	M?	n/a	n/a	
<i>Allothunnus fallai</i>	slender tuna		US	<i>T. albacares</i>	M?	n/a	n/a	
<i>Auxis rochei</i>	bullet mackerel		US	<i>T. albacares</i>	M?	n/a	n/a	
<i>Auxis thazard</i>	frigate mackerel		US	<i>T. albacares</i>	M?	n/a	n/a	
<i>Euthynnus affinis</i>	kawakawa		US	<i>T. albacares</i>	M?	n/a	n/a	
<i>Euthynnus alletteratus</i>	little tunny		US	<i>T. albacares</i>	M?	n/a	n/a	
<i>Euthynnus lineatus</i>	black skipjack		US	<i>T. albacares</i>	M?	n/a	n/a	
<i>Katsuwonus pelamis</i>	skipjack tuna		US	<i>T. albacares</i>	M?	n/a	n/a	
<i>Sarda chiliensis</i>	Pacific bonito		US	<i>T. albacares</i>	M?	n/a	n/a	
<i>Sarda sarda</i>	Atlantic bonito		US	<i>T. albacares</i>	M?	n/a	n/a	
<i>Scomber colias</i>	Atlantic chub mackerel		US	<i>T. albacares</i>	M?	n/a	n/a	
<i>Scomber japonicus</i>	Pacific chub mackerel		US	<i>T. albacares</i>	M?	n/a	n/a	
<i>Scomber scombrus</i>	Atlantic mackerel		US	<i>T. albacares</i>	M?	n/a	n/a	
<i>Scomberomorus cavalla</i>	king mackerel		US	<i>T. albacares</i>	M?	n/a	n/a	
<i>Scomberomorus concolor</i>	Gulf sierra		US	<i>T. albacares</i>	M?	n/a	n/a	
<i>Scomberomorus maculatus</i>	Spanish mackerel		US	<i>T. albacares</i>	M?	n/a	n/a	
<i>Scomberomorus regalis</i>	cero		US	<i>T. albacares</i>	M?	n/a	n/a	
<i>Scomberomorus sierra</i>	Pacific sierra		US	<i>T. albacares</i>	M?	n/a	n/a	
<i>Thunnus alalunga</i>	albacore		US	<i>T. albacares</i>	M?	n/a	n/a	

Appendix Table C-5 Worldwide listing of marine fish species (non-elasmobranch) for which information on sensitivity to electric or magnetic fields has been suggested or studied, along with related species from US waters and any federally listed threatened (T) or endangered (E) species. (continued)

Species ^a	Common Name	Status ^b	US? ^c	Evidence Taxon	Sensitivity ^d	Sensory Range	Evidence Basis	Citation
<i>Thunnus albacares</i>	yellowfin tuna		US	direct	M	10 to 50 μ T changes to field	behavioral: conditioned response	Walker 1984
<i>Thunnus albacares</i>	yellowfin tuna		US	direct	M	n/a	anatomical: magnetite crystals	Walker et al. 1984
<i>Thunnus albacares</i>	yellowfin tuna		US	<i>T. albacares</i>	M	10 to 50 μ T changes to field	behavioral/ anatomical	
<i>Thunnus atlanticus</i>	blackfin tuna		US	<i>T. albacares</i>	M?	n/a	n/a	
<i>Thunnus obesus</i>	bigeye tuna		US	<i>T. albacares</i>	M?	n/a	n/a	
<i>Thunnus orientalis</i>	Pacific bluefin tuna		US	<i>T. albacares</i>	M?	n/a	n/a	
<i>Thunnus thynnus</i>	bluefin tuna		US	<i>T. albacares</i>	M?	n/a	n/a	
Order Pleuronectiformes, Family Pleuronectidae: righteye flounders								
<i>Atheresthes evermanni</i>	Kamchatka flounder		US	<i>P. platessa</i>	M?	n/a	n/a	
<i>Atheresthes stomias</i>	arrowtooth flounder		US	<i>P. platessa</i>	M?	n/a	n/a	
<i>Embassichthys bathybius</i>	deepsea sole		US	<i>P. platessa</i>	M?	n/a	n/a	
<i>Eopsetta jordani</i>	petrale sole		US	<i>P. platessa</i>	M?	n/a	n/a	
<i>Glyptocephalus cynoglossus</i>	witch flounder		US	<i>P. platessa</i>	M?	n/a	n/a	
<i>Glyptocephalus zachirus</i>	rex sole		US	<i>P. platessa</i>	M?	n/a	n/a	
<i>Hippoglossoides elassodon</i>	flathead sole		US	<i>P. platessa</i>	M?	n/a	n/a	
<i>Hippoglossoides platessoides</i>	American plaice		US	<i>P. platessa</i>	M?	n/a	n/a	
<i>Hippoglossoides robustus</i>	Bering flounder		US	<i>P. platessa</i>	M?	n/a	n/a	
<i>Hippoglossus hippoglossus</i>	Atlantic halibut		US	<i>P. platessa</i>	M?	n/a	n/a	
<i>Hippoglossus stenolepis</i>	Pacific halibut		US	<i>P. platessa</i>	M?	n/a	n/a	
<i>Isopsetta isolepis</i>	butter sole		US	<i>P. platessa</i>	M?	n/a	n/a	
<i>Lepidopsetta bilineata</i>	rock sole		US	<i>P. platessa</i>	M?	n/a	n/a	
<i>Lepidopsetta polyxystra</i>	northern rock sole		US	<i>P. platessa</i>	M?	n/a	n/a	
<i>Limanda aspera</i>	yellowfin sole		US	<i>P. platessa</i>	M?	n/a	n/a	

Appendix Table C-5 Worldwide listing of marine fish species (non-elasmobranch) for which information on sensitivity to electric or magnetic fields has been suggested or studied, along with related species from US waters and any federally listed threatened (T) or endangered (E) species. (continued)

Species ^a	Common Name	Status ^b	US? ^c	Evidence Taxon	Sensitivity ^d	Sensory Range	Evidence Basis	Citation
<i>Limanda ferruginea</i>	yellowtail flounder		US	<i>P. platessa</i>	M?	n/a	n/a	
<i>Limanda proboscidea</i>	longhead dab		US	<i>P. platessa</i>	M?	n/a	n/a	
<i>Limanda sakhalinensis</i>	Sakhalin sole		US	<i>P. platessa</i>	M?	n/a	n/a	
<i>Lyopsetta exilis</i>	slender sole		US	<i>P. platessa</i>	M?	n/a	n/a	
<i>Microstomus pacificus</i>	Dover sole		US	<i>P. platessa</i>	M?	n/a	n/a	
<i>Parophrys vetulus</i>	English sole		US	<i>P. platessa</i>	M?	n/a	n/a	
<i>Platichthys flesus</i>	European Flounder		Not in US	direct	none	n/a	none: toxicity study - no lethal effects from exposure to 3.7 mT DC fields for 7 weeks	Bochert and Zettler 2004
<i>Platichthys stellatus</i>	starry flounder		US	<i>P. platessa</i>	M?	n/a	n/a	
<i>Pleuronectes glacialis</i>	Arctic flounder		US	<i>P. platessa</i>	M?	n/a	n/a	
<i>Pleuronectes platessa</i>	European plaice		Not in US	direct	M?	geomagnetic field	behavioral: orientation	Metcalf et al. 1993
<i>Pleuronectes putnami</i>	smooth flounder		US	<i>P. platessa</i>	M?	n/a	n/a	
<i>Pleuronectes quadrituberculatus</i>	Alaska plaice		US	<i>P. platessa</i>	M?	n/a	n/a	
<i>Pleuronichthys coenosus</i>	C-O sole		US	<i>P. platessa</i>	M?	n/a	n/a	
<i>Pleuronichthys decurrens</i>	curlfin sole		US	<i>P. platessa</i>	M?	n/a	n/a	
<i>Pleuronichthys guttulatus</i>	diamond turbot		US	<i>P. platessa</i>	M?	n/a	n/a	
<i>Pleuronichthys ocellatus</i>	ocellated turbot		US	<i>P. platessa</i>	M?	n/a	n/a	
<i>Pleuronichthys ritteri</i>	spotted turbot		US	<i>P. platessa</i>	M?	n/a	n/a	
<i>Pleuronichthys verticalis</i>	hornyhead turbot		US	<i>P. platessa</i>	M?	n/a	n/a	
<i>Psettichthys melanostictus</i>	sand sole		US	<i>P. platessa</i>	M?	n/a	n/a	
<i>Pseudopleuronectes americanus</i>	winter flounder		US	<i>P. platessa</i>	M?	n/a	n/a	
<i>Reinhardtius hippoglossoides</i>	Greenland halibut		US	<i>P. platessa</i>	M?	n/a	n/a	

Appendix Table C-5 Worldwide listing of marine fish species (non-elasmobranch) for which information on sensitivity to electric or magnetic fields has been suggested or studied, along with related species from US waters and any federally listed threatened (T) or endangered (E) species. (continued)

^aSpecies listed alphabetically within Family. ^bStatus: federal threatened (T) or endangered (E) status; ^cUS?: US=species occurs in US waters, Not in US=species does not occur in US waters; ^dSensitivity: sensitivity findings, M=magnetosensitivity, E=electrosensitivity, none=species studied with no sensitivity reported. ^eShaded rows summarize findings for US species.

Appendix Table C-6

Natural history characteristics of priority fish species (non-elasmobranch) in US waters. Status= threatened (T) or endangered (E)

Species	Common Name	Status	EFH ^a	Habitat	Depth (m)	Movement	Seasonal Occurrence	Lifestage Occurrence	Citation
Superclass Agnatha, Class Cephalaspidomorphi, Order Petromyzontiformes, Family Petromyzontidae: lampreys									
<i>Lampetra ayresii</i>	river lamprey			demersal	n/a	migratory	Adults spawn during April and May in fresh water rivers and streams.	Adults found in estuaries and ocean, returning to freshwater to spawn. Juveniles reside in freshwater.	Miller and Lea 1972, Froese and Pauly 2010
<i>Lampetra camtschatica</i>	Arctic lamprey			demersal	0 to 50	migratory	Anadromous and freshwater resident populations. Adults spawn in freshwater streams and rivers from April through August depending on latitude.	Juveniles and resident populations live in freshwater. Anadromous forms migrate to sea and return to spawn.	Froese and Pauly 2010
<i>Lampetra tridentata</i>	Pacific lamprey			demersal	0 to 1100	migratory	Adults spawn in the spring and juveniles live in freshwater prior to emigrating to marine waters.	Adults migrate from Pacific Ocean during spring and summer and spawn the next spring. Juveniles reside in freshwater prior to emigrating to marine waters.	Miller and Lea 1972, Froese and Pauly 2010
<i>Petromyzon marinus</i>	sea lamprey			demersal	1 to 2200	migratory	Adults migrate to freshwater from Atlantic Ocean in spring to spawn.	Larvae spend 6 to 8 years in freshwater prior to emigrating to marine waters. Adults live 20 to 30 months in sea prior to returning to freshwater to spawn.	Froese and Pauly 2010, Collette and Klein-MacPhee 2002
Class Chondrichthyes, Subclass Holocephali, Order Chimaeriformes, Family Chimaeridae: shortnose chimaeras									
<i>Hydrolagus collieri</i>	spotted ratfish		P	demersal	shallow to 400		Spawning likely occurs year round.	Ratfish reside near the bottom, eggs can be found in benthic sediment.	Miller and Lea 1972, Froese and Pauly 2010

Appendix Table C-6 Natural history characteristics of priority fish species (non-elasmobranch) in US waters. Status= threatened (T) or endangered (E) (continued)

Species	Common Name	Status	EFH ^a	Habitat	Depth (m)	Movement	Seasonal Occurrence	Lifestage Occurrence	Citation
Class Actinopterygii: ray-finned fishes									
Class Actinopterygii, Subclass Chondrostei, Order Acipenseriformes, Family Acipenseridae: sturgeons									
<i>Acipenser brevirostrum</i>	shortnose sturgeon	E		benthic	primarily estuarine, occasional nearshore coastal	non-migratory	Spawning begins in late winter/early spring (southern rivers) to mid to late-spring (northern rivers).	Spawn in fresh water. Adults inhabit nearshore marine, estuarine and riverine habitat of large river systems. Juveniles (up to 10 yrs) are estuarine.	NMFS 1998, NMFS 2010a
<i>Acipenser medirostris</i>	green sturgeon	T		benthic	shallow to 122	migratory	Adult spawning migrations in late February; spawning from March-July.	Adults predominantly marine, found in nearshore oceanic waters, bays, and estuaries. Spawn in rivers (freshwater). Juveniles spend 1-4 years in fresh and estuarine waters before dispersal to marine waters.	NMFS 2010a, Miller and Lea 1972
<i>Acipenser oxyrinchus</i>	Atlantic sturgeon			benthic	shallow to 50	migratory	Adult spawning migrations into rivers in spring/early summer	Adults spawn in freshwater; juveniles in estuarine nurseries; adults in marine coastal waters	ASSRT 2007, Collette and Klein-MacPhee 2002
<i>Acipenser oxyrinchus desotoi</i>	Gulf sturgeon	T		benthic	shallow to 55	migratory	Adults enter rivers in February to April to spawn and return to marine waters in September to November.	Adults spawn in freshwater and migrate into marine waters to forage and overwinter. Juveniles remain in rivers for the first 2-3 years.	NMFS 2010a, USFWS and GSMFC 1995
<i>Acipenser transmontanus</i>	white sturgeon			benthic	shallow to 122	migratory	Adults move into large rivers in the early spring, and spawn May through June.	Adults predominantly marine, Juveniles in fresh and estuarine waters.	Miller and Lea 1972, PSMFC 2010

Appendix Table C-6 (continued)

Natural history characteristics of priority fish species (non-elasmobranch) in US waters. Status= threatened (T) or endangered (E)

Species	Common Name	Status	EFH ^a	Habitat	Depth (m)	Movement	Seasonal Occurrence	Lifestage Occurrence	Citation
Class Actinopterygii, Subclass Neopterygii, Infraclass Teleostei: teleost fishes									
Order Anguilliformes, Family Anguillidae: freshwater eels									
<i>Anguilla rostrata</i>	American eel			demersal	0 to 464	migratory	Common in streams, rivers, lakes, marshes, and estuaries. Adults migrate to Sargasso Sea in late summer and fall on spawning run.	Juveniles migrate from marine environment to freshwater in spring where they remain until sexually mature. Adults reside in fresh water and estuaries, migrating to Sargasso Sea in summer/fall to spawn.	Froese and Pauly 2010, Collette and Klein-MacPhee 2002
Order Siluriformes, Family Ariidae: sea catfishes									
<i>Bagre marinus</i>	gafftopsail catfish			demersal	0 to 50	non-migratory		Mainly marine, but will enter brackish estuaries with high salinities.	Froese and Pauly 2010
<i>Bagre panamensis</i>	chihuil			demersal	shallow	non-migratory		Generally found inshore near muddy bottoms.	Froese and Pauly 2010
Order Salmoniformes, Family Osmeridae: smelts									
<i>Thaleichthys pacificus</i>	eulachon	T		pelagic	shallow to 300	migratory	Adults spawn in large rivers and tributaries between March and May.	Adults primarily marine fish (typically nearshore), spawning in fresh water. Larvae carried downstream to estuaries soon after hatching.	Miller and Lea 1972, Froese and Pauly 2010
Order Salmoniformes, Family Salmonidae: trouts and salmon									
<i>Coregonus clupeaformis</i>	lake whitefish			demersal	18 to 128	migratory			Froese and Pauly 2010
<i>Oncorhynchus clarkii</i>	cutthroat trout			demersal	0 to 200	migratory	Adults conduct spawning migrations from marine waters to rivers and streams from February through July depending on range location.	Adults generally remain 80 km from natal river. Juveniles spend 1 to 3 years in freshwater streams before migrating to marine waters (March through June).	Behnke 2002, Froese and Pauly 2010

Appendix Table C-6 Natural history characteristics of priority fish species (non-elasmobranch) in US waters. Status= threatened (T) or endangered (E) (continued)

Species	Common Name	Status	EFH ^a	Habitat	Depth (m)	Movement	Seasonal Occurrence	Lifestage Occurrence	Citation
<i>Oncorhynchus gorbuscha</i>	pink salmon		P	demersal	shallow to 250	migratory	Spawning occurs from August through November in freshwater tributaries.	Adults spend 18 months at sea and spawn in freshwater rivers. Juveniles move downstream into estuarine areas immediately after hatching.	Miller and Lea 1972, Froese and Pauly 2010, NMFS 2010b
<i>Oncorhynchus keta</i>	chum salmon	T		benthopelagic	shallow to 250	migratory	Spawning occurs primarily in September and October in freshwater tributaries.	Juveniles migrate to estuaries soon after hatching in rivers. Juveniles spend a few months in estuaries prior to moving into ocean. Adults move from ocean to freshwater rivers and tributaries to spawn.	Miller and Lea 1972, Froese and Pauly 2010, NMFS 2010b
<i>Oncorhynchus kisutch</i>	coho salmon	E/T	NP, P	demersal	shallow to 250	migratory	Juveniles occur in rivers and near coast after migrating to ocean. Adults live in ocean returning to freshwater rivers to spawn.	eggs hatch in spring and juveniles spend as much as 4 years in tributaries prior to migrating downstream to estuaries. As juveniles grow to adults they move further offshore.	Miller and Lea 1972, Froese and Pauly 2010, NMFS 2010b
<i>Oncorhynchus mykiss</i>	steelhead trout	E/T		benthopelagic	shallow to 200	migratory	Spawning occurs in freshwater river from February through June.	Eggs hatch in spring and juveniles generally spend 2-3 years in freshwater prior to migrating to ocean. Adults live in ocean 1-2 years before returning in spring to spawn in rivers.	Froese and Pauly 2010, Collette and Klein-MacPhee 2002

Appendix Table C-6 Natural history characteristics of priority fish species (non-elasmobranch) in US waters. Status= threatened (T) or endangered (E) (continued)

Species	Common Name	Status	EFH ^a	Habitat	Depth (m)	Movement	Seasonal Occurrence	Lifestage Occurrence	Citation
<i>Oncorhynchus nerka</i>	sockeye salmon	E/T		pelagic	shallow to 250	migratory	Adults migrate to freshwater and spawn in lakes or rivers associated with lakes from July to December depending on range location	Juveniles usually spend 1-3 years in freshwater (usually lakes) before migrating to the Pacific Ocean. Adults move further off shore with growth and return to freshwater rivers to spawn.	Miller and Lea 1972, Froese and Pauly 2010
<i>Oncorhynchus tshawytscha</i>	Chinook salmon	E/T	NP, P	benthopelagic	shallow to 375	migratory	Adults migrate to freshwater in either March throughout the year depending on the specific run. Regardless of migration timing, all spawning occurs during the fall.	Juveniles emigrate to the ocean after an extended freshwater residence (typically 1 year). Two adult forms, a nearshore coastal oriented form and an offshore form exist in North American waters.	NMFS 2005 and Froese and Pauly 2010
<i>Salmo salar</i>	Atlantic salmon	E	NE/MA	benthopelagic	shallow to 210	migratory	Adults migrate to freshwater from April to October and spawn from late October through November.	Eggs hatch in the spring and juveniles spend 1-8 years in freshwater prior to emigrating to the Atlantic Ocean. There Atlantic salmon spend 1-2 years before returning to natal rivers to spawn.	Froese and Pauly 2010, Collette and Klein-MacPhee 2002
<i>Salvelinus alpinus</i>	Arctic char			benthopelagic	30 to 70	migratory	Anadromous forms migrate to salt water during spring and summer, returning to freshwater to spawn.		Froese and Pauly 2010
<i>Salvelinus confluentus</i>	bull trout			benthopelagic	n/a	migratory	Bull trout migrating to brackish water do so during spring and summer, returning to spawn. Adults spawn over gravel in freshwater streams and rivers from late summer to fall.	Mainly a freshwater species, rarely anadromous.	Froese and Pauly 2010

Appendix Table C-6 Natural history characteristics of priority fish species (non-elasmobranch) in US waters. Status= threatened (T) or endangered (E) (continued)

Species	Common Name	Status	EFH ^a	Habitat	Depth (m)	Movement	Seasonal Occurrence	Lifestage Occurrence	Citation
<i>Salvelinus fontinalis</i>	brook trout			demersal	15 to 27	migratory	Spawning occurs in rivers and stream from late August in the north and through late December in the extreme south of the brook trouts range.	Fish typically greater than 15 cm migrate from fresh to brackish water in April and May for periods of a few days to 4 months. Adults and juveniles return to freshwater in late summer or fall.	Froese and Pauly 2010, Collette and Klein-MacPhee 2002
<i>Salvelinus malma</i>	Dolly Varden			benthopelagic	0 to 200	migratory	Anadromous forms migrate to marine waters during summer, returning to freshwater for spawning (August through November).	Anadromous juveniles spend up to 3 years in freshwater streams before venturing into marine waters during spring/summer.	Froese and Pauly 2010
Order Perciformes, Family Scombridae: mackerels									
<i>Acanthocybium solandri</i>	wahoo		SA	pelagic	0 to 12	migratory	Spawning occurs March through October (peaking in June).	Eggs and larvae are pelagic, wahoo range expands to northern latitudes during warmer summer months.	Froese and Pauly 2010, NMFS 2010c.
<i>Auxis rochei</i>	bullet mackerel			pelagic	10+	migratory	Spawning occurs in open water at various times of the year depending on location.	Adults are pelagic and neritic.	Froese and Pauly 2010
<i>Auxis thazard</i>	frigate mackerel			pelagic	50+	migratory	Adult spawn in open water at various times of the year depending on location.	Adults are epipelagic and neritic.	Froese and Pauly 2010
<i>Euthynnus affinis</i>	kawakawa			pelagic	0 to 200	migratory	Adults spawn in open water throughout the year depending on range.	Adults remain in open water close to shoreline, juveniles may enter bays and harbors.	Miller and Lea 1972, Froese and Pauly 2010

Appendix Table C-6 Natural history characteristics of priority fish species (non-elasmobranch) in US waters. Status= threatened (T) or endangered (E) (continued)

Species	Common Name	Status	EFH ^a	Habitat	Depth (m)	Movement	Seasonal Occurrence	Lifestage Occurrence	Citation
<i>Euthynnus alletteratus</i>	little tunny		G, SA	pelagic	1 to 150	migratory	Adults spawn from April through November.	An inshore neritic fish in tropical/sub-tropical waters of the Atlantic Ocean. Eggs and larvae are pelagic.	Froese and Pauly 2010, Collette and Klein-MacPhee 2002
<i>Euthynnus lineatus</i>	black skipjack			pelagic	0 to 40	migratory	Occurs in tropical waters (rarely under 26°C). In the Gulf of California, adults spawn from October through December.	Inhabits surface of coastal and offshore waters, larvae confined to waters within 240 miles of mainland.	Froese and Pauly 2010
<i>Katsuwonus pelamis</i>	skipjack tuna		P, S	pelagic	0 to 260	migratory	Typically found offshore, adults spawn throughout year in tropical waters.	Found throughout tropical and warm temperate waters.	Froese and Pauly 2010, Collette and Klein-MacPhee 2002
<i>Sarda chiliensis</i>	Pacific bonito			pelagic	n/a	migratory	Spawning occurs between January through May in open waters.	Inshore species forming schools by size.	Froese and Pauly 2010
<i>Sarda sarda</i>	Atlantic bonito			pelagic	80 to 200	migratory	Adult spawn in open water during June and July.	Adults are epipelagic and neritic, moving north with warmer waters in summer.	Froese and Pauly 2010, Collette and Klein-MacPhee 2002
<i>Scomber colias</i>	Atlantic chub mackerel			pelagic	n/a		Adults can be found in shallow or deep water.	Typically found in warm neritic waters on both coasts.	Froese and Pauly 2010
<i>Scomber japonicus</i>	Pacific chub mackerel		P	pelagic	0 to 300	migratory	A nearshore species conducting diel migrations from deep to surface waters at night. Spawning occurs mainly from April through August.	Adults spawn in open water, eggs and larvae are pelagic.	Froese and Pauly 2010
<i>Scomber scombrus</i>	Atlantic mackerel			pelagic	0 to 183	migratory	Northern group spawns in Gulf of St. Lawrence during June and July, a southern group spawns in the Mid-Atlantic Bight during April and May.	Adults of northern and southern groups migrate extensively between summer and spawning grounds.	Froese and Pauly 2010, NMFS 2010c, Collette and Klein-MacPhee 2002

Appendix Table C-6 Natural history characteristics of priority fish species (non-elasmobranch) in US waters. Status= threatened (T) or endangered (E) (continued)

Species	Common Name	Status	EFH ^a	Habitat	Depth (m)	Movement	Seasonal Occurrence	Lifestage Occurrence	Citation
<i>Scomberomorus cavalla</i>	king mackerel		G, SA	pelagic	5 to 140 (usually 5 to 15)	migratory	Adults spawn May through October on the outer continental shelf.	A nearshore reef associated species moving north with warm water during the summer.	Froese and Pauly 2010, NMFS 2010c, Collette and Klein-MacPhee 2002
<i>Scomberomorus maculatus</i>	Spanish mackerel		G, SA	pelagic	10 to 35	migratory	Adult spawning occurs in open water (April through September) off the coasts of VA and NC as well as in the Gulf of Mexico.	Adult Spanish mackerel migrate north with warm waters in the summer returning south in the winter.	Froese and Pauly 2010, NMFS 2010c, Collette and Klein-MacPhee 2002
<i>Scomberomorus regalis</i>	cero		G, SA	pelagic	1 to 20	migratory	Abundant nearshore around coral reefs.	Spawns offshore throughout the year (mainly April and May).	Froese and Pauly 2010, NMFS 2010c, Collette and Klein-MacPhee 2002
<i>Scomberomorus sierra</i>	Pacific sierra			pelagic	0 to 12	migratory	Adults believed to spawn close to coast over much of range.	Occurs near coastal waters to over bottom of continental shelf	Froese and Pauly 2010, Miller and Lea 1972
<i>Thunnus alalunga</i>	albacore		P, S	pelagic	0 to 600	migratory	Albacore spawn in spring and summer in open sub-tropical waters. A highly migratory fish throughout its range.	Eggs and larvae or pelagic. Juveniles are typically found in warm water at surface while adults are in deeper cooler waters.	Froese and Pauly 2010, NMFS 2010c
<i>Thunnus albacares</i>	yellowfin tuna		P, S	pelagic	1 to 250 (usually 1 to 100)	migratory	Spawning occurs May through August in the Gulf of Mexico and throughout tropical waters in the Pacific mainly during spring and fall.	Juveniles typically restricted to warmer surface waters, adults can be found at various depths.	Froese and Pauly 2010, NMFS 2010c
<i>Thunnus atlanticus</i>	blackfin tuna			pelagic	50 and greater	migratory	Spawning occurs in open water from April through November, peaking in May.	Typically located well offshore, occasionally not far from coast.	Froese and Pauly 2010, NMFS 2010c

Appendix Table C-6 Natural history characteristics of priority fish species (non-elasmobranch) in US waters. Status= threatened (T) or endangered (E) (continued)

Species	Common Name	Status	EFH ^a	Habitat	Depth (m)	Movement	Seasonal Occurrence	Lifestage Occurrence	Citation
<i>Thunnus obesus</i>	bigeye tuna		P, S	pelagic	0 to 250	migratory	Adults spawn in open water throughout the year peaking in summer months.	Eggs are pelagic, larvae are found in tropical waters and as they grow fish move into temperate waters.	Froese and Pauly 2010, NMFS 2010c
<i>Thunnus orientalis</i>	Pacific bluefin tuna		P	pelagic	1 to 200	migratory	Fish migrate north along the West Coast from June through September.	Form schools by size, usually oceanic but seasonally coming close to shore.	Froese and Pauly 2010, NMFS 2010c
<i>Thunnus thynnus</i>	bluefin tuna		S	pelagic	0 to 985	migratory	Spawning occurs mid April through June in the Florida Straits and Gulf of Mexico.	Oceanic fish, seasonally coming close to shore. Migrate north with warmer summer temperatures.	Froese and Pauly 2010, NMFS 2010c

^aEFH=Essential Fish Habitat has been designated by the listed Fishery Management Council: NP=North Pacific, P=Pacific, NE/MA=New England/Mid-Atlantic, SA=South Atlantic, G=Gulf of Mexico, and S=Secretarial (NMFS 2010b).

Appendix Table C-7

Geographic range of priority fish species (non-elasmobranch) in US waters.

Species	Common Name	Geographic range	Critical/important areas	Citation
Superclass Agnatha, Class Cephalaspidomorphi, Order Petromyzontiformes, Family Petromyzontidae: lampreys				
<i>Lampetra ayresii</i>	river lamprey	Tea Harbor, Alaska south to Sacramento-San Joaquin drainage in California.		Miller and Lea 1972, Froese and Pauly 2010
<i>Lampetra camtschatica</i>	Arctic lamprey	Arctic region of Alaska south to Pacific coast of Canada.		Froese and Pauly 2010
<i>Lampetra tridentata</i>	Pacific lamprey	Central Baja California, Mexico to Bering Sea coast of Alaska.		Miller and Lea 1972, Froese and Pauly 2010
<i>Petromyzon marinus</i>	sea lamprey	In western Atlantic Ocean, from west coast of Greenland south to Florida and northern shore of Gulf of Mexico		Froese and Pauly 2010, Collette and Klein-MacPhee 2002
Class Chondrichthyes, Subclass Holocephali, Order Chimaeriformes, Family Chimaeridae: shortnose chimaeras				
<i>Hydrolagus coliei</i>	spotted ratfish	Tiburon Isl. Gulf of California (isolated population) and Sebastian Viscaino Bay, Baja California to S.E. Alaska.		Miller and Lea 1972, Froese and Pauly 2010
Class Actinopterygii: ray-finned fishes				
Class Actinopterygii, Subclass Chondrostei, Order Acipenseriformes, Family Acipenseridae: sturgeons				
<i>Acipenser brevirostrum</i>	shortnose sturgeon	St. John River, Canada to St. Johns River, Florida		NMFS 1998, NMFS 2010a
<i>Acipenser medirostris</i>	green sturgeon	Mexico to Alaska (Bering Sea)	Critical habitat has been designated within coastal marine waters within 60 fathoms (fm) depth, and certain estuaries and rivers from Monterey Bay, California, north to Cape Flattery, Washington.	NMFS 2010a, Miller and Lea 1972
<i>Acipenser oxyrinchus</i>	Atlantic sturgeon	St. Croix River, ME to the Saint Johns River, Florida		ASSRT 2007, Collette and Klein-MacPhee 2002
<i>Acipenser oxyrinchus desotoi</i>	Gulf sturgeon	River systems, nearshore bays, estuaries, and coastal areas in the Gulf of Mexico from Louisiana to Florida.	Critical habitat designated for Gulf sturgeon in spawning rivers and adjacent estuarine areas (14 geographic areas) from Florida and Louisiana.	NMFS 2010a, USFWS and GSMFC 1995

Appendix Table C-7 Geographic range of priority fish species (non-elasmobranch) in US waters. (continued)

Species	Common Name	Geographic range	Critical/important areas	Citation
<i>Acipenser transmontanus</i>	white sturgeon	Mexico to Alaska (Gulf of Alaska)		Miller and Lea 1972, PSMFC 2010
Class Actinopterygii, Subclass Neopterygii, Infraclass Teleostei: teleost fishes				
Order Anguilliformes, Family Anguillidae: freshwater eels				
<i>Anguilla rostrata</i>	American eel	Southern Greenland south along Canadian and US coast to northern South America, including Gulf of Mexico		Froese and Pauly 2010, Collette and Klein-MacPhee 2002
Order Siluriformes, Family Ariidae: sea catfishes				
<i>Bagre marinus</i>	gafftopsail catfish	Massachusetts to northern South America, including Gulf of Mexico		Froese and Pauly 2010
<i>Bagre panamensis</i>	chihuil	Santa Anna River, CA to Peru, including Gulf of California		Froese and Pauly 2010
Order Salmoniformes, Family Osmeridae: smelts				
<i>Thaleichthys pacificus</i>	eulachon	Monterey Bay, CA to Bering Sea west of St. Matthew Island and Kuskokwim Bay, AK		Miller and Lea 1972, Froese and Pauly 2010
Order Salmoniformes, Family Salmonidae: trouts and salmons				
<i>Coregonus clupeaformis</i>	lake whitefish	Populations along coasts in North America occur in Alaska and Canada south to New England.		Froese and Pauly 2010
<i>Oncorhynchus clarkii</i>	cutthroat trout	Found in Pacific Ocean tributaries from Prince William Sound, AK to Eel River, CA		Behnke 2002, Froese and Pauly 2010
<i>Oncorhynchus gorbuscha</i>	pink salmon	La Jolla, CA to Arctic Alaska		Miller and Lea 1972, Froese and Pauly 2010
<i>Oncorhynchus keta</i>	chum salmon	Del Mar, CA to Arctic Alaska	Critical habitat has been designated in parts of the Pacific Northwest	Miller and Lea 1972, Froese and Pauly 2010, NMFS 2010a
<i>Oncorhynchus kisutch</i>	coho salmon	Chamalu Bay, Baja California to Bearing Sea, Alaska	Critical habitat has been designated in parts of central and northern CA and the Pacific Northwest	Miller and Lea 1972, Froese and Pauly 2010, NMFS 2010a

Appendix Table C-7 Geographic range of priority fish species (non-elasmobranch) in US waters. (continued)

Species	Common Name	Geographic range	Critical/important areas	Citation
<i>Oncorhynchus mykiss</i>	steelhead trout	Southern California to Kuskokwim River, AK	Critical habitat has been designated in parts of CA and the Pacific Northwest	Froese and Pauly 2010, Collette and Klein-MacPhee 2002, NMFS 2010a
<i>Oncorhynchus nerka</i>	sockeye salmon	Sacramento River system to Bering Sea	Critical habitat has been designated in parts of the Pacific Northwest	Miller and Lea 1972, Froese and Pauly 2010, NMFS 2010a
<i>Oncorhynchus tshawytscha</i>	Chinook salmon	Arctic to Ventura River, CA	Critical habitat has been designated in parts of central and northern CA and the Pacific Northwest	NMFS 2010a, NMFS 2005, Froese and Pauly 2010
<i>Salmo salar</i>	Atlantic salmon	Northern Quebec to Connecticut	Critical habitat and HAPC designated for Maine rivers	NMFS 2010a, Froese and Pauly 2010, Collette and Klein-MacPhee 2002
<i>Salvelinus alpinus</i>	Arctic char	Anadromous populations in North America restricted to Canada and Alaska		Froese and Pauly 2010
<i>Salvelinus confluentus</i>	bull trout	Pacific coastal streams from Arctic to McCloud River drainage, CA		Froese and Pauly 2010
<i>Salvelinus fontinalis</i>	brook trout	Canada south to Georgia. Brook trout enter salt water in the northern parts of its range		Froese and Pauly 2010, Collette and Klein-MacPhee 2002
<i>Salvelinus malma</i>	Dolly Varden	Alaska to Puget Sound, WA (formerly to McCloud River CA)		Froese and Pauly 2010
Order Perciformes, Family Scombridae: mackerels				
<i>Acanthocybium solandri</i>	wahoo	Found in tropical and sub tropical waters worldwide including both Atlantic and Pacific Ocean.		Froese and Pauly 2010, NMFS 2010c.
<i>Auxis rochei</i>	bullet mackerel	World-wide distribution, primarily in coastal waters		Froese and Pauly 2010
<i>Auxis thazard</i>	frigate mackerel	World-wide distribution in warm waters		Froese and Pauly 2010
<i>Euthynnus affinis</i>	kawakawa	Indo-West Pacific, few specimens collected in Eastern Central Pacific (as far north as Los Angeles Harbor)		Miller and Lea 1972, Froese and Pauly 2010

Appendix Table C-7 Geographic range of priority fish species (non-elasmobranch) in US waters. (continued)

Species	Common Name	Geographic range	Critical/important areas	Citation
<i>Euthynnus alletteratus</i>	little tunny	Tropical and sub-tropical waters of the Atlantic Ocean including the Gulf of Mexico and Caribbean Sea.	HAPC designated in the Southeast	Froese and Pauly 2010, Collette and Klein-MacPhee 2002
<i>Euthynnus lineatus</i>	black skipjack	San Simeon, CA south to Peru		Froese and Pauly 2010
<i>Katsuwonus pelamis</i>	skipjack tuna	Tropical and temperate waters of the Atlantic and Pacific Oceans.		Froese and Pauly 2010, Collette and Klein-MacPhee 2002
<i>Sarda chiliensis</i>	Pacific bonito	Chile to the Gulf of Alaska		Froese and Pauly 2010
<i>Sarda sarda</i>	Atlantic bonito	Nova Scotia, Canada to Argentina, including northern Gulf of Mexico. Absent from much of Caribbean Sea.		Froese and Pauly 2010, Collette and Klein-MacPhee 2002
<i>Scomber colias</i>	Atlantic chub mackerel	South America north to Canada		Froese and Pauly 2010
<i>Scomber japonicus</i>	Pacific chub mackerel	South America north to the Gulf of Alaska		Froese and Pauly 2010
<i>Scomber scombrus</i>	Atlantic mackerel	Labrador Canada to North Carolina		Froese and Pauly 2010, NMFS 2010c, Collette and Klein-MacPhee 2002
<i>Scomberomorus cavalla</i>	king mackerel	Warm waters of the Atlantic Ocean occurring regularly to North Carolina and occasionally to southern Massachusetts.	HAPC designated in the Southeast	Froese and Pauly 2010, NMFS 2010c, Collette and Klein-MacPhee 2002
<i>Scomberomorus maculatus</i>	Spanish mackerel	Gulf of Mexico north to Chesapeake Bay. Summer visitors as far north as New York and occasionally New England.	HAPC designated in the Southeast	Froese and Pauly 2010, NMFS 2010c, Collette and Klein-MacPhee 2002
<i>Scomberomorus regalis</i>	cero	warm waters of the western Atlantic Ocean including the Gulf of Mexico north to Cape Cod, MA.	HAPC designated in the Southeast	Froese and Pauly 2010, NMFS 2010c, Collette and Klein-MacPhee 2002
<i>Scomberomorus sierra</i>	Pacific sierra	Peru to Santa Monica, CA		Froese and Pauly 2010, Miller and Lea 1972
<i>Thunnus alalunga</i>	albacore	Tropical through temperate waters in the Atlantic and Pacific Oceans		Froese and Pauly 2010, NMFS 2010c

Appendix Table C-7 Geographic range of priority fish species (non-elasmobranch) in US waters. (continued)

Species	Common Name	Geographic range	Critical/important areas	Citation
<i>Thunnus albacares</i>	yellowfin tuna	Warm water extending to approximately 40°N in the Pacific and in tropical and sub-tropical waters of the Atlantic		Froese and Pauly 2010, NMFS 2010c
<i>Thunnus atlanticus</i>	blackfin tuna	From South America north to Martha's Vineyard, MA		Froese and Pauly 2010, NMFS 2010c
<i>Thunnus obesus</i>	bigeye tuna	Canada to Argentina in the Atlantic Ocean and tropical/sub tropical waters in the Pacific Ocean.		Froese and Pauly 2010, NMFS 2010c
<i>Thunnus orientalis</i>	Pacific bluefin tuna	Baja California to the Gulf of Alaska		Froese and Pauly 2010, NMFS 2010c
<i>Thunnus thynnus</i>	bluefin tuna	Gulf of Mexico to Newfoundland Canada		Froese and Pauly 2010, NMFS 2010c

Appendix Table C-8

Worldwide listing of marine mammals for which information on sensitivity to magnetic fields has been suggested or studied, along with related species from US waters and any federally listed threatened (T) or endangered (E) species.

Species ^a	Common Name	Status ^b	US? ^c	Evidence Taxon	Sensitivity ^d	Sensory Range	Evidence Basis	Citation
Mysticeti								
<i>Balaena mysticetus</i>	bowhead whale	E	US					
<i>Balaenoptera borealis</i>	sei whale	E	US					
<i>Balaenoptera musculus</i>	blue whale	E	US					
<i>Balaenoptera physalus</i>	fin whale	E	US	direct	M	0.05 μ T; earth's magnetic field	theoretical	Kirschvink 1990; Walker et al. 1992
<i>Eschrichtius robustus</i>	gray whale		US					
<i>Eubalaena glacialis</i>	North Atlantic right whale	E	US					
<i>Eubalaena japonica</i>	North Pacific right whale	E	US					
<i>Megaptera novaeangliae</i>	humpback whale	E	US	direct	M	earth's magnetic field	anatomical-magnetite in dura matter	Bauer et al. 1985
Odontoceti								
<i>Delphinapterus leucas</i>	beluga whale	E	US					
<i>Delphinus capensis</i>	long-beaked common dolphin		US					
<i>Delphinus delphis</i>	common dolphin		US		M;M;M	earth's magnetic field;0.05 μ T	anatomical-magnetite in dura matter; theoretical; theoretical	Zoeger et al.1981; Kirschvink et al. 1986; Kirschvink 1990; Hui 1994
<i>Globicephala macrorhynchus</i>	short-fin pilot whale		US	direct	M	0.05 μ T	theoretical	Kirschvink et al. 1986; Kirschvink 1990
<i>Globicephala melaena</i>	long-fin pilot whale		US	direct	M	earth's magnetic field;0.05 μ T	theoretical	Kirschvink et al. 1986; Kirschvink 1990
<i>Grampus griseus</i>	Risso's dolphin				none		theoretical	Kirschvink 1990

Appendix Table C-8 Worldwide listing of marine mammals for which information on sensitivity to magnetic fields has been suggested or studied, along with related species from US waters and any federally listed threatened (T) or endangered (E) species. (continued)

Species ^a	Common Name	Status ^b	US? ^c	Evidence Taxon	Sensitivity ^d	Sensory Range	Evidence Basis	Citation
<i>Kogia breviceps</i>	pygmy sperm whale		US	direct	M	earth's magnetic field;0.05 μT	theoretical	Kirschvink et al. 1986; Kirschvink 1990
<i>Kogia simus</i>	dwarf sperm whale		US	direct	none			Kirschvink 1990
<i>Lagenorhynchus acutus</i>	Atlantic white-sided dolphin		US	direct	M	0.05 μT	theoretical	Kirschvink 1990
<i>Orcinus orca</i>	killer whale	E	US	direct				
<i>Phocoena phocena</i>	harbor porpoise		US		M	0.05 μT	theoretical	Kirschvink 1990
<i>Phocoenoides dalli</i>	Dall's porpoise		US		M		Anatomical - in dura matter	Bauer et al. 1985
<i>Physeter macrocephalus</i>	sperm whale	E	US	direct	M	earth's magnetic field;0.05 μT	theoretical	Kirschvink et al. 1986; Kirschvink 1990
<i>Stenella coeruleoalba</i>	striped dolphin				M	earth's magnetic field;0.05 μT	theoretical	Kirschvink et al. 1986; Kirschvink 1990
<i>Stenella plagidon/frontalis</i>	Atlantic spotted dolphin		US	direct	M	0.05 μT	theoretical	Kirschvink 1990
<i>Tursiops truncatus</i>	bottlenose dolphin		US		M; M; none	earth's magnetic field;0.05 μT	behavioral/physiological; anatomical - magnetite in dura matter; theoretical	Kuznetsov 1999; Bauer et al. 1985; Kirschvink 1990
<i>Ziphius cavirostris</i>	Cuvier's beaked whale		US		none			Kirschvink 1990
Order Sirenia								
<i>Trichechus manatus latirostris</i>	Florida manatee	E	US					

^aSpecies listed alphabetically within Family. ^bStatus: federal threatened (T) or endangered (E) status; ^cUS?: US=species occurs in US waters, Not in US=species does not occur in US waters; ^dSensitivity: sensitivity findings, M=magnetosensitivity, E=electrosensitivity, none=species studied with no sensitivity reported. Shaded rows summarize findings for US species.

Appendix Table C-9

Natural history characteristics of priority marine mammal species in US waters.

Species	Common Name	Status	Habitat	Depth (m)	Movement	Seasonal Occurrence	Lifestage Occurrence	Citation
Mysticeti								
<i>Balaena mysticetus</i>	bowhead whale	E	pelagic	cont. shelf and slope	migration			Allen and Angliss 2010
<i>Balaenoptera borealis</i>	sei whale	E	pelagic	nearshore to cont. shelf edge	migration			Waring et al. 2009; Carretta et al. 2009
<i>Balaenoptera musculus</i>	blue whale	E	pelagic	Pacific =near shore to EEZ; Atlantic = within EEZ	migration			Waring et al. 2009; Carretta et al. 2009
<i>Balaenoptera physalus</i>	fin whale	E	pelagic	Pacific =near shore to EEZ; Atlantic = nearshore to 1000	migration			Waring et al. 2009; Carretta et al. 2009
<i>Eschrichtius robustus</i>	gray whale		benthic	nearshore to 155	migration			Carretta et al. 2009; Cipriano 2009
<i>Eubalaena glacialis</i>	North Atlantic right whale	E	pelagic	coastal waters to >200	migration			Baumgartner and Wenzel 2005
<i>Eubalaena japonica</i>	North Pacific right whale	E	pelagic	cont. shelf <100	migration			Carretta et al. 2009
<i>Megaptera novaeangliae</i>	humpback whale	E	pelagic	Pacific = nearshore; Atlantic = nearshore to 1000	migration			Waring et al. 2009; Carretta et al. 2009
Odontoceti								
<i>Delphinapterus leucas</i>	beluga whale	E	benthic	shallow nearshore to 20	migration			NMFS 2009
<i>Delphinus capensis</i>	long-beaked common dolphin		pelagic	nearshore, within 50 nm of coast	migration			Carretta et al. 2009
<i>Delphinus delphis</i>	common dolphin		pelagic	Pacific = nearshore to EEZ; Atlantic =cont. shelf waters 200-2000	migration			Waring et al. 2009; Carretta et al. 2009
<i>Globicephala macrorhynchus</i>	short-fin pilot whale		pelagic	Pacific = within EEZ; Gulf of Mex. = 100-1000; Atlantic = 100-4000	migration			Waring et al. 2009; Carretta et al. 2009
<i>Globicephala melaena</i>	long-fin pilot whale		pelagic	100-4000	migration			Waring et al. 2009
<i>Kogia breviceps</i>	pygmy sperm whale		pelagic/ demersal	Pacific = cont. slope; Gulf of Mex. = 100-1000+; Atlantic = 100-4000	migration			Waring et al. 2009; Carretta et al. 2009
<i>Kogia simus</i>	dwarf sperm whale		pelagic/ demersal	Pacific = cont. slope; Gulf of Mex. = 100-1000+; Atlantic = 100-4000	migration			Waring et al. 2009; Carretta et al. 2009

Appendix Table C-9 Natural history characteristics of priority marine mammal species in US waters. (continued)

Species	Common Name	Status	Habitat	Depth (m)	Movement	Seasonal Occurrence	Lifestage Occurrence	Citation
<i>Lagenorhynchus acutus</i>	Atlantic white-sided dolphin		pelagic/bent hopelagic	nearshore to 100	movement/migration			Waring et al. 2009
<i>Lagenorhynchus obliquidens</i>	Pacific white-sided dolphin		pelagic/bent hopelagic	WA to CA = cont. shelf and slope; AK = inshore to shelf and slope				Carretta et al. 2009
<i>Orcinus orca</i>	killer whale	E	pelagic	Pacific = inshore to outer coastal waters; Gulf of Mex. = 1000+; Atlantic = within EEZ	migration			Allen and Angliss 2010; Waring et al. 2009; Carretta et al. 2009
<i>Phocoena phocena</i>	harbor porpoise		pelagic/benthic	20-60	movement between areas?			Carretta et al. 2001
<i>Phocoenoides dalli</i>	Dall's porpoise		pelagic/bent hopelagic	nearshore cont. shelf and slope waters to offshore	migration			Allen and Angliss 2010; Carretta et al. 2009
<i>Physeter macrocephalus</i>	sperm whale	E	pelagic/demersal	Pacific = cont. shelf and slope; Atlantic = 100 - 4000 and inshore of 100 south of New England; Gulf of Mex. = 1000+	migration			Allen and Angliss 2010; Waring et al. 2009; Carretta et al. 2009
<i>Stenella plagiodon/frontalis</i>	Atlantic spotted dolphin		pelagic/benthic	Gulf of Mex. = 10-200 to cont. slope <500; Atlantic = inshore and cont. shelf and slope	movement/migration			Waring et al. 2009
<i>Tursiops truncatus</i>	bottlenose dolphin		pelagic/benthic	inshore bays and estuaries to cont. shelf	migration			Waring et al. 2009; Carretta et al. 2009
Order Sirenia								
<i>Trichechus manatus longirostris</i>	Florida manatee	E	benthic	<50				USFWS 2007

Appendix Table C-10

Geographic range of priority marine mammal species in US waters.

Species	Common Name	US Geographic Range	Critical/important Areas	Citation
Mysticeti				
<i>Balaena mysticetus</i>	bowhead whale	AK (Aleutian Islands, Frontier, And Northslope)		Allen and Angliss 2010
<i>Balaenoptera borealis</i>	sei whale	North Atlantic And WA, OR, And CA		Waring et al. 2009; Carretta et al. 2009
<i>B. musculus</i>	blue whale	North Atlantic, AK (Aleutian Islands), WA, OR, And CA		Waring et al. 2009; Carretta et al. 2009; Allen and Angliss 2010
<i>B. physalus</i>	fin whale	North Atlantic, AK (Aleutian Islands And Frontier), WA, OR, And CA		Waring et al. 2009; Carretta et al. 2009; Allen and Angliss 2010
<i>Eubalaena glacialis</i>	North Atlantic right whale	North Atlantic To The Straits Of Florida	Bay of Fundy, Scotian Shelf, Cape Cod Bay, Massachusetts Bay, Great South Channel, southeastern U.S. coast (FL-GA)	NMFS 2009
<i>E. japonicus</i>	North Pacific right whale	AK (Aleutian Islands), WA, OR And CA	Bering Sea, Gulf of Alaska	Allen and Angliss 2010; Carretta et al. 2009
<i>Eschrichtius robustus</i>	gray whale	AK (Aleutian Islands, Frontier, And Northslope), WA, OR, And CA		Allen and Angliss 2010; Carretta et al. 2009
<i>Megaptera novaeangliae</i>	humpback whale	North Atlantic To The Straits Of Florida, AK (Aleutian Islands And Frontier), WA, OR, To Central CA		Waring et al. 2009; Carretta et al. 2009; Allen and Angliss 2010
Odontoceti				
<i>Delphinapterus leucas</i>	beluga whale	AK (Aleutian Islands, Frontier, And Northslope)	Cook Inlet, AK (NMFS proposed critical habitat December 2009)	NMFS 2009
<i>Delphinus capensis</i>	long-beaked common dolphin	Central To Southern CA		Carretta et al. 2009
<i>Delphinus delphis</i>	common dolphin	North To Mid-Atlantic, WA, OR, And CA		Waring et al. 2009; Carretta et al. 2009
<i>Globicephala macrorhynchus</i>	short-fin pilot whale	North Atlantic To Western Gulf Of Mexico, WA, OR, And CA		Waring et al. 2009; Carretta et al. 2009
<i>G. melaena</i>	long-fin pilot whale	North To Mid-Atlantic		Waring et al. 2009
<i>Kogia breviceps</i>	pygmy sperm whale	North Atlantic To Western Gulf Of Mexico, And CA		Waring et al. 2009; Carretta et al. 2009

Appendix Table C-10 Geographic range of priority marine mammal species in US waters. (continued)

Species	Common Name	US Geographic Range	Critical/important Areas	Citation
<i>K. simus</i>	dwarf sperm whale	North Atlantic To Western Gulf Of Mexico, And CA		Waring et al. 2009; Carretta et al. 2009
<i>Lagenorhynchus acutus</i>	Atlantic white-sided dolphin	North Atlantic		Waring et al. 2009
<i>Lagenorhynchus obliquidens</i>	Pacific white-sided dolphin	AK (Aleutian Islands), WA, OR, And CA		Carretta et al. 2009; Allen and Angliss 2010
<i>Orcinus orca</i>	killer whale	North Atlantic, Gulf Of Mexico, And AK (Aleutian Islands), WA, OR, And CA	WA : 1) Summer Core Area in Haro Strait and waters around San Juan Islands, 2) Puget Sound, and 3) Strait of San Juan de Fuca	NMFS 2009
<i>Phocoena phocoena</i>	harbor porpoise	North To Mid-Atlantic, AK (Frontier And Aleutian Islands), WA, OR, And CA		Waring et al. 2009; Carretta et al. 2009; Allen and Angliss 2010
<i>Phocoenoides dalli</i>	Dall's porpoise	AK (Aleutian Islands), WA, OR, And CA		Carretta et al. 2009; Allen and Angliss 2010
<i>Physeter macrocephalus</i>	sperm whale	North To Mid-Atlantic, AK (Frontier And Aleutian Islands), WA, OR, And CA		Waring et al. 2009; Carretta et al. 2009; Allen and Angliss 2010
<i>S. frontalis/plagidon</i>	Atlantic spotted dolphin	North Atlantic To Western Gulf Of Mexico	Pacific northeast offshore (depleted)	Waring et al. 2009
<i>Tursiops truncatus</i>	bottlenose dolphin	North Atlantic To Western Gulf Of Mexico, And Southern CA	Western North Atlantic (depleted)	Waring et al. 2009; Carretta et al. 2009
Order Sirenia				
<i>Trichechus manatus longirostris</i>	Florida manatee	Florida, As Far North As MA, As Far West As TX	multiple sites in northeast to southwest FL	USFWS 2007

Appendix Table C-11

Worldwide listing of sea turtles for which information on sensitivity to magnetic fields has been suggested or studied, along with related species from US waters and any federally listed threatened (T) or endangered (E) species.

Species ^a	Common Name	Status ^b	US? ^c	Evidence Taxon	Sensitivity ^d	Sensory range	Evidence Basis	Citation
Class Reptilia, Order Testudines								
	sea turtles		US	C. mydas, C. caretta	M	23-45 μ T	behavioral-field and lab controlled experiments	Courtillot et al. 1997
	sea turtles		US	C. mydas, C. caretta	M	geomagnetic field	behavioral; experimental	Lohmann et al. 2008a
Class Reptilia, Order Testudines, Family Cheloniidae								
<i>Caretta caretta</i>	loggerhead turtle	T	US	direct	M	4000 μ T	experimental	Avens and Lohmann 2003
<i>Caretta caretta</i>	loggerhead turtle	T	US	direct	M?	?	experimental-displacement	Avens and Lohmann 2004
<i>Caretta caretta</i>	loggerhead turtle	T	US	direct	M	geomagnetic field	experimental-displacement	Avens et al. 2003
<i>Caretta caretta</i>	loggerhead turtle	T	US	direct	M	geomagnetic field	experimental-displacement	Cain et al. 2005
<i>Caretta caretta</i>	loggerhead turtle	T	US	direct	M	4.69-4.71 nT; inclination angle 57.5°	experimental-wave tank	Goff et al. 1998
<i>Caretta caretta</i>	loggerhead turtle	T	US	direct	M	7400 μ T	experimental-arena	Irwin and Lohmann 2003
<i>Caretta caretta</i>	loggerhead turtle	T	US	direct	M	40 μ T	experimental-arena	Irwin and Lohmann 2005
<i>Caretta caretta</i>	loggerhead turtle	T	US	direct	M	horizontal component = 0.028 mT; vertical component = 0.039 mT; total field strength = 0.048 mT	experimental-arena	Light et al. 1993
<i>Caretta caretta</i>	loggerhead turtle	T	US	direct	M	geomagnetic field	experimental-arena	Lohmann 1991

Appendix Table C-11 Worldwide listing of sea turtles for which information on sensitivity to magnetic fields has been suggested or studied, along with related species from US waters and any federally listed threatened (T) or endangered (E) species. (continued)

Species ^a	Common Name	Status ^b	US? ^c	Evidence Taxon	Sensitivity ^d	Sensory range	Evidence Basis	Citation
<i>Caretta caretta</i>	loggerhead turtle	T	US	direct	M	horizontal component = 23,000-26,000 nT	experimental-arena	Lohmann and Lohmann 1994a
<i>Caretta caretta</i>	loggerhead turtle	T	US	direct	M	0.44-0.45 mT	experimental-arena	Lohmann and Lohmann 1994b
<i>Caretta caretta</i>	loggerhead turtle	T	US	direct	M	43,000-52,000 nT	experimental-displacement	Lohmann and Lohmann 1996
<i>Caretta caretta</i>	loggerhead turtle	T	US	direct	M	geomagnetic field	experimental	Lohmann et al. 1999
<i>Caretta caretta</i>	loggerhead turtle	T	US	direct	M	geomagnetic field	experimental	Lohmann et al. 2001
<i>Caretta caretta</i>	loggerhead turtle	T	US	<i>Caretta caretta</i>	M	geomagnetic field		
<i>Chelonia mydas</i>	green turtle	E/T	US	direct	M	geomagnetic field	experimental	Alerstam et al 2003
<i>Chelonia mydas</i>	green turtle	E/T	US	direct	M?	?	experimental-displacement	Avens and Lohmann 2004
<i>Chelonia mydas</i>	green turtle	E/T	US	direct	none	n/a	observation-satellite tracking	Hays et al. 2002
<i>Chelonia mydas</i>	green turtle	E/T	US	direct	none	n/a	experimental-displacement; observation-satellite tagging	Hays et al. 2003
<i>Chelonia mydas</i>	green turtle	E/T	US	direct	M	change in local intensity (39.7μT) =10.4μT	experimental-effects from metal cage	Irwin et al. 2004
<i>Chelonia mydas</i>	green turtle	E/T	US	direct	M	geomagnetic field	experimental	Lohmann et al. 1999
<i>Chelonia mydas</i>	green turtle	E/T	US	direct	M	45.4-49.3 μT	experimental-displacement	Lohmann et al. 2004

Appendix Table C-11 Worldwide listing of sea turtles for which information on sensitivity to magnetic fields has been suggested or studied, along with related species from US waters and any federally listed threatened (T) or endangered (E) species. (continued)

Species ^a	Common Name	Status ^b	US? ^c	Evidence Taxon	Sensitivity ^d	Sensory range	Evidence Basis	Citation
<i>Chelonia mydas</i>	green turtle	E/T	US	direct	M	geomagnetic field	experimental	Lohmann et al. 2008b
<i>Chelonia mydas</i>	green turtle	E/T	US	direct	none	n/a	experimental-displacement	Luschi et al. 2001
<i>Chelonia mydas</i>	green turtle	E/T	US	direct	M	200 µT	experimental-displacement	Luschi et al. 2007
<i>Chelonia mydas</i>	green turtle	E/T	US	direct	none	450,000-6,500,000 nT	experimental	Papi et al. 2000
<i>Chelonia mydas</i>	green turtle	E/T	US	<i>Chelonia mydas</i>	M	geomagnetic field		
<i>Eretmochelys imbricata</i>	hawksbill turtle	E	US	<i>C. mydas, C. caretta</i>	M	geomagnetic field		
<i>Lepidochelys kempii</i>	Kemp's ridley turtle	E	US	direct	M	geomagnetic field	theoretical	Putman and Lohmann 2008
<i>Lepidochelys kempii</i>	Kemp's ridley turtle	E	US	<i>Lepidochelys kempii</i>	M	geomagnetic field		
<i>Lepidochelys olivacea</i>	olive ridley turtle	E/T	US	<i>C. mydas, C. caretta</i>	M	geomagnetic field		
Class Reptilia, Order Testudines, Family Dermochelyidae								
<i>Dermochelys coriacea</i>	leatherback turtle	E	US	direct	M	geomagnetic field	experimental	Lohmann and Lohmann 1993
<i>Dermochelys coriacea</i>	leatherback turtle	E	US	<i>Dermochelys coriacea</i>	M	geomagnetic field		

^aSpecies listed alphabetically within Family. ^bStatus: federal threatened (T) or endangered (E) status; ^cUS?: US=species occurs in US waters, Not in US=species does not occur in US waters; ^dSensitivity: sensitivity findings, M=magnetosensitivity, E=electrosensitivity, none=species studied with no sensitivity reported. Shaded rows summarize findings for US species.

Appendix Table C-12

Natural history characteristics of sea turtles in US waters

Species	Common Name	Status	Habitat	Depth (m)	Movement	Seasonal Occurrence	Lifestage Occurrence	Citation
Class Reptilia, Order Testudines, Family Cheloniidae								
<i>Caretta caretta</i>	loggerhead turtle	T		*233	migratory		adults	Lutcavage and Lutz 1997
			open ocean/neritic	0 - >200	migratory		subadults	Lutcavage and Lutz 1997
<i>Chelonia mydas</i>	green turtle	E/T	nesting beaches	to shore	migratory		adults, hatchlings	
			coastal/benthic	0 - 20	migratory		adults, juveniles	Lutcavage and Lutz 1997
			convergence zones/open ocean	*110	migratory		adults, juveniles	Lutcavage and Lutz 1997
<i>Eretmochelys imbricata</i>	hawksbill turtle	E	Sargassum rafts	>100	migratory		post hatchlings	
			coastal/benthic	0 - 20	migratory		juveniles, adults	Lutcavage and Lutz 1997
<i>Lepidochelys kempii</i>	Kemp's ridley turtle	E	coastal/benthic	0 - 50	migratory		juveniles, adults	Lutcavage and Lutz 1997
<i>Lepidochelys olivacea</i>	olive ridley turtle	E/T	open ocean	*290	migratory		adults	Lutcavage and Lutz 1997
Class Reptilia, Order Testudines, Family Dermochelyidae								
	leatherback turtle	E	nesting beaches	to shore	migratory		adults, hatchlings	
<i>Dermochelys coriacea</i>			open ocean/seasonally coastal	*>1000/<200	migratory		adults	Lutcavage and Lutz 1997

Appendix Table C-13

Geographic range of sea turtles in US waters.

Species	Common Name	US Geographic range	Critical/important areas	Citation
Class Reptilia, Order Testudines, Family Cheloniidae				
<i>Caretta caretta</i>	loggerhead turtle	North Carolina to Florida (and minimally west to Texas and north to Virginia); Alaska to San Diego, California	Archie Carr National Wildlife Refuge, Florida	NMFS 2010c
<i>Chelonia mydas</i>	green turtle	Massachusetts to Texas, Caribbean; Alaska to San Diego, California	Puerto Rico; proposed South San Diego Bay National Wildlife Refuge	NMFS 2010a
<i>Eretmochelys imbricata</i>	hawksbill turtle	Massachusetts to Texas, Caribbean	Puerto Rico	NMFS 2010a
<i>Lepidochelys kempii</i>	Kemp's ridley turtle	New England to Texas		NMFS 2010a
<i>Lepidochelys olivacea</i>	olive ridley turtle	Southern California		NMFS 2010a
Class Reptilia, Order Testudines, Family Dermochelyidae				
<i>Dermochelys coriacea</i>	leatherback turtle	Maine to the Caribbean and the Gulf of Mexico; Washington to California	St. Croix, U.S. Virgin Islands; proposed Washington to Oregon and central to southern California	NMFS 2010a

Appendix Table C-14

Worldwide listing of marine invertebrates for which information on sensitivity to electric or magnetic fields has been suggested or studied, along with related species from US waters and any federally listed threatened (T) or endangered (E) species.

Species ^a	Common Name	Status ^b	US? ^c	Evidence Taxon	Sensitivity ^d	Sensory Range	Evidence Basis	Citation
Phylum Cnidaria, Class Anthozoa, Order Scleractinia, Family Acroporidae								
<i>Acropora cervicornis</i> ^e	staghorn coral	T	US					
<i>Acropora palmata</i>	elkhorn coral	T	US					
Phylum Mollusca, Class Gastropoda, Order Archaeogastropoda, Family Haliotidae								
<i>Haliotis cracherodii</i>	black abalone	E	US					
<i>Haliotis sorenseni</i>	white abalone	E	US					
Phylum Mollusca, Class Gastropoda, Order Opisthobranchia, Family Tritoniidae								
<i>Tritonia diomedea</i>	sea slug		US	direct	M	geomagnetic field	physiological: neural response	Cain et al 2006
<i>Tritonia diomedea</i>	sea slug		US	direct	M	geomagnetic field	behavioral: orientation	Lohmann and Willows 1987
<i>Tritonia diomedea</i>	sea slug		US	direct	M	geomagnetic field	physiological: neural response	Lohmann et al 1991
<i>Tritonia diomedea</i>	sea slug		US	direct	M	geomagnetic field	physiological: neural response	Popescu and Willows 1999
<i>Tritonia diomedea</i>	sea slug		US	direct	M	geomagnetic field	physiological: neural response	Wang et al 2003
<i>Tritonia diomedea</i>	sea slug		US	direct	M	geomagnetic field	physiological: neural response	Wang et al 2004
<i>Tritonia diomedea</i>	sea slug		US	direct	M	geomagnetic field	behavioral: orientation	Willows 1999
<i>Tritonia diomedea</i>	sea slug		US	<i>T. diomedea</i>	M	geomagnetic field	behavioral: orientation	
Phylum Mollusca, Class Bivalvia, Order Mytiloidea, Family Mytilidae								
<i>Mytilus edulis</i>	blue mussel		US	direct	none	n/a	none: toxicity study - no lethal effects from exposure to 3.7 mT DC fields for 7 weeks	Bochert and Zettler 2004
<i>Mytilus edulis</i>	blue mussel		US	<i>M. edulis</i>	none	n/a	none: toxicity study - no lethal effects from exposure to 3.7 mT DC fields for 7 weeks	
<i>Mytilus galloprovincialis</i>	Mediterranean mussel		Not in US	direct	M	300 – 600 μ T	physiological: changes to shape of immunocytes	Malagoli et al 2003

Appendix Table C-14 Worldwide listing of marine invertebrates for which information on sensitivity to electric or magnetic fields has been suggested or studied, along with related species from US waters and any federally listed threatened (T) or endangered (E) species. (continued)

Species ^a	Common Name	Status ^b	US? ^c	Evidence Taxon	Sensitivity ^d	Sensory Range	Evidence Basis	Citation
<i>Mytilus galloprovincialis</i>	Mediterranean mussel		Not in US	direct	M	400 μ T, 50 Hz	physiological: increased concentration of heat shock proteins	Malagoli et al 2004
<i>Mytilus galloprovincialis</i>	Mediterranean mussel		Not in US	direct	M	300-700 μ T	physiological: changes to shape of immunocytes	Ottaviani et al 2002
<i>Mytilus galloprovincialis</i>	Mediterranean mussel		Not in US	<i>M. galloprovincialis</i>	M	300-700 μ T	physiological	
Phylum Arthropoda, Subphylum Crustacea, Class Malacostraca								
Order Isopoda, Family Chaetiliidae								
<i>Saduria entomon</i>	glacial relict isopod		US	direct	none	n/a	none: toxicity study - no lethal effects from exposure to 3.7 mT DC fields for 7 weeks	Bochert and Zettler 2004
<i>Saduria entomon</i>	glacial relict isopod		US	<i>S. entomon</i>	none	n/a	none: toxicity study - no lethal effects from exposure to 3.7 mT DC fields for 7 weeks	
Order Isopoda, Family Idoteidae								
<i>Idotea baltica basteri</i>	marine isopod		Not in US	direct	M	geomagnetic field	behavioral: orientation	Ugolini and Pezzani 1995
<i>Idotea baltica basteri</i>	marine isopod		Not in US	<i>I. baltica basteri</i>	M	geomagnetic field	behavioral: orientation	
Order Amphipoda, Family Talitridae								
<i>Talorchestia martensii</i>	sandhopper		Not in US	direct	M	geomagnetic field	behavioral	Ugolini 2006
<i>Talorchestia martensii</i>	sandhopper		Not in US	<i>T. martensii</i>	M	geomagnetic field	behavioral	

Appendix Table C-14 Worldwide listing of marine invertebrates for which information on sensitivity to electric or magnetic fields has been suggested or studied, along with related species from US waters and any federally listed threatened (T) or endangered (E) species. (continued)

Species ^a	Common Name	Status ^b	US? ^c	Evidence Taxon	Sensitivity ^d	Sensory Range	Evidence Basis	Citation
Order Decapoda, Infraorder Caridea, Family Crangonidae								
<i>Crangon crangon</i>	North Sea prawn		Not in US	direct	none	n/a	none: toxicity study - no lethal effects from exposure to 3.7 mT DC fields for 7 weeks	Bochert and Zettler 2004
<i>Crangon crangon</i>	North Sea prawn		Not in US	<i>C. crangon</i>	none	n/a	none: toxicity study - no lethal effects from exposure to 3.7 mT DC fields for 7 weeks	
Order Decapoda, Infraorder Astacidea, Family Nephropidae								
<i>Homarus vulgaris</i>	European lobster		Not in US	direct	none	n/a	none: No neural response to 500 Hz 0.2 T or a 50 Hz 0.8 T magnetic field	Ueno et al 1986
<i>Homarus vulgaris</i>	European lobster		Not in US	<i>H. vulgaris</i>	none	n/a	none: No neural response to 500 Hz 0.2 T or a 50 Hz 0.8 T magnetic field	
Order Decapoda, Infraorder Astacidea, Family Cambaridae								
Order Decapoda	Crayfish		Not in US	direct	M	1-400 μ T, 0.001-100 Hz	physiological: neural response	Uzdensky et al 1997
Order Decapoda	Crayfish		Not in US	Crayfish	M	1-400 μ T, 0.001-100 Hz	physiological: neural response	
<i>Procambarus clarkii</i>	freshwater crayfish (Southeastern US)		Not in US	direct	M	frequency: <12 Hz magnetic	physiological: neural response; no response above 12 Hz	Delgado 1985
<i>Procambarus clarkii</i>	freshwater crayfish (Southeastern US)		Not in US	direct	E	20 mV/cm	behavioral: feeding response; weak response	Steullet et al 2007
<i>Procambarus clarkii</i>	freshwater crayfish (Southeastern US)		Not in US	direct	E	8.08 mT	physiological	Ye et al 2004
<i>Procambarus clarkii</i>	freshwater crayfish (Southeastern US)		Not in US	<i>P. clarkii</i>	E	20 mV/cm; 8.08 mT	behavioral/ physiological	

Appendix Table C-14 Worldwide listing of marine invertebrates for which information on sensitivity to electric or magnetic fields has been suggested or studied, along with related species from US waters and any federally listed threatened (T) or endangered (E) species. (continued)

Species ^a	Common Name	Status ^b	US? ^c	Evidence Taxon	Sensitivity ^d	Sensory Range	Evidence Basis	Citation
Order Decapoda, Infraorder Astacidea, Family Parastacidae								
<i>Cherax destructor</i>	Australian freshwater crayfish		Not in US	direct	E	current densities of 0.4 $\mu\text{A}/\text{cm}^2$	behavioral	Patullo and Macmillan 2007
<i>Cherax destructor</i>	Australian freshwater crayfish		Not in US	<i>C. destructor</i>	E	current densities of 0.4 $\mu\text{A}/\text{cm}^2$	behavioral	
Order Decapoda, Infraorder Palinura, Family Palinuridae								
<i>Justitia longimanus</i>	West Indian furrow lobster		US	<i>P. argus</i>	M?			
<i>Panulirus argus</i>	Caribbean spiny lobster		US	direct	M	geomagnetic field	behavioral: orientation	Boles and Lohmann 2003
<i>Panulirus argus</i>	Caribbean spiny lobster		US	direct	M	n/a	anatomical: magnetic material in body	Lohmann 1984
<i>Panulirus argus</i>	Caribbean spiny lobster		US	direct	M	geomagnetic field	behavioral: orientation	Lohmann 1985
<i>Panulirus argus</i>	Caribbean spiny lobster		US	direct	M	geomagnetic field	behavioral: orientation	Lohmann et al 1995
<i>Panulirus argus</i>	Caribbean spiny lobster		US	<i>P. argus</i>	M	geomagnetic field	behavioral/ anatomical	
<i>Panulirus guttatus</i>	spotted spiny lobster		US	<i>P. argus</i>	M?			
<i>Panulirus interruptus</i>	California spiny lobster		US	<i>P. argus</i>	M?			
<i>Panulirus laevicauda</i>	smoothtail spiny lobster		US	<i>P. argus</i>	M?			
<i>Panulirus longipes</i>	longlegged spiny lobster		US	<i>P. argus</i>	M?			

Appendix Table C-14 Worldwide listing of marine invertebrates for which information on sensitivity to electric or magnetic fields has been suggested or studied, along with related species from US waters and any federally listed threatened (T) or endangered (E) species. (continued)

Species ^a	Common Name	Status ^b	US? ^c	Evidence Taxon	Sensitivity ^d	Sensory Range	Evidence Basis	Citation
Order Decapoda, Infraorder Brachyura, Family Panopeidae								
<i>Rhithropanopeus harrisi</i>	round crab		US	direct	none	n/a	none: toxicity study - no lethal effects from exposure to 3.7 mT DC fields for 7 weeks	Bochert and Zettler 2004
<i>Rhithropanopeus harrisi</i>	round crab		US	<i>R. harrisi</i>	none	n/a	none: toxicity study - no lethal effects from exposure to 3.7 mT DC fields for 7 weeks	
Phylum Echinodermata, Class Echinoidea, Order Temnopleuroida, Family Toxopneustidae								
<i>Lytechinus pictus</i>	sea urchin		US	direct	M	30 mT	physiological: embryonic development	Levin and Ernst 1997
<i>Lytechinus pictus</i>	sea urchin		US	<i>L. pictus</i>	M	30 mT	physiological: embryonic development	
Phylum Echinodermata, Class Echinoidea, Order Echinoida, Family Strongylocentrotidae								
<i>Strongylocentrotus purpuratus</i>	purple sea urchin		US	direct	M	frequency: 60 Hz magnetic	physiological: embryonic development	Cameron et al 1993
<i>Strongylocentrotus purpuratus</i>	purple sea urchin		US	direct	M	30 mT	physiological: embryonic development	Levin and Ernst 1997
<i>Strongylocentrotus purpuratus</i>	purple sea urchin		US	<i>S. purpuratus</i>	M	30 mT	physiological: embryonic development	

^a Species listed alphabetically within Family. ^bStatus: federal threatened (T) or endangered (E) status; ^cUS?: US=species occurs in US waters, Not in US=species does not occur in US waters; ^dSensitivity: sensitivity findings, M=magnetosensitivity, E=electrosensitivity, none=species studied with no sensitivity reported.

^eShaded rows summarize findings for US species.

Appendix Table C-15

Natural history characteristics of priority invertebrate species in US waters.

Species	Common Name	Status	EFH ^a	Habitat	Depth (m)	Movement	Seasonal occurrence	Lifestage occurrence	Citation
Phylum Mollusca, Class Gastropoda, Order Opisthobranchia, Family Tritoniidae									
<i>Tritonia diomedea</i>	sea slug			benthic	shallow sublittoral to 750				Katz 2007
Phylum Arthropoda, Subphylum Chelicerata, Class Merostomata									
<i>Limulus polyhemus</i>	horseshoe crab			benthic	intertidal to 20	migratory	winter offshore, adults move inshore to spawn intertidally	planktonic larvae. Juveniles and adults benthic	ASFMC 2011
Phylum Arthropoda, Subphylum Crustacea, Class Malacostraca									
Order Decapoda, Infraorder Palinura, Family Palinuridae									
<i>Justitia longimanus</i>	West Indian furrow lobster			benthic	1 to 300 (usually between 50 and 100)			inhabits the outer edges of coral reef slopes	Holthuis 1991
<i>Panulirus argus</i>	Caribbean spiny lobster		G, SA	benthic	shallow water; occasionally to 90 m or more	migratory	Adults move along and offshore seasonally to avoid cold/turbid water. Spawning occurs year round in Caribbean and from April through September in southeast US	Larvae float in water column while post larvae inhabit dense vegetation near shore. Adults inhabit rocky areas and coral reefs.	Holthuis 1991 and NMFS 2010c
<i>Panulirus guttatus</i>	Spotted spiny lobster			benthic	shallow water		Mainly inhabits rocky areas and crevices.		Holthuis 1991
<i>Panulirus interruptus</i>	California spiny lobster			benthic	shallow to 65	migratory	Adults spawn May through August	Juveniles utilize shallow vegetated reefs and surfgrass beds. Adults occur mainly on rocky substrates, more common in deeper waters.	Holthuis 1991
<i>Panulirus laevicauda</i>	Smoothtail spiny lobster			benthic	shallow to 50			occurs on rock substrate or coral	Holthuis 1991
Order Decapoda, Infraorder Astacidea, Family Nephropidae									
<i>Homarus americanus</i>	American lobster			benthic	shallow to 40	migratory	onshore/offshore migration; prefers rocky habitat but can occupy all substrates; summer spawning	planktonic larvae; early benthic phase and juvenile lifestages exhibit strong habitat preferences	ASFMC 2011
Order Decapoda, Infraorder Brachyura, Family Cancridae									
<i>Metacarcinus magister</i>	Dungeness crab			benthic	up 100	migratory	onshore/offshore migration	planktonic larvae	Pauley et al. 1986

^a EFH=Essential Fish Habitat has been designated by the listed Fishery Management Council: NP=North Pacific, P=Pacific, NE/MA=New England/Mid-Atlantic, SA=South Atlantic, G=Gulf of Mexico, and S=Secretarial (NMFS 2010b).

Appendix Table C-16

Geographic range of priority invertebrate species in US waters.

Species	Common Name	Geographic Range	Critical/Important Areas	Citation
Phylum Mollusca, Class Gastropoda, Order Opisthobranchia, Family Tritoniidae				
<i>Tritonia diomedea</i>	sea slug	Alaska to California		Katz 2007
Phylum Arthropoda, Subphylum Chelicerata, Class Merastomata				
<i>Limulus polyphemus</i>	horseshoe crab	Gulf of Mexico to Maine	preserve designated in mid-Atlantic	ASFMC 2011
Phylum Arthropoda, Subphylum Crustacea, Class Malacostraca				
Order Decapoda, Infraorder Palinura, Family Palinuridae				
<i>Justitia longimanus</i>	West Indian furrow lobster	Bermuda, South Florida, Cuba south to Ilsa Margarita, Curacao, and E. Brazil.		Holthuis 1991
<i>Panulirus argus</i>	Caribbean spiny lobster	South America to North Carolina including Gulf of Mexico and Caribbean Islands	HAPC designated for spiny lobster in the Southeast	Holthuis 1991, NMFS 2010c
<i>Panulirus guttatus</i>	Spotted spiny lobster	South Florida, Bermuda and Caribbean Islands south to northern parts of South America		Holthuis 1991
<i>Panulirus interruptus</i>	California Spiny lobster	San Luis Obispo Bay, CA to Baja California, Mexico		Holthuis 1991
<i>Panulirus laevicauda</i>	Smoothtail spiny lobster	Florida, Bermuda to East Brazil including Caribbean Islands and Central America from Yucatan south.		Holthuis 1991

Appendix Table C-16 Geographic range of priority invertebrate species in US waters. (continued)

Species	Common Name	Geographic Range	Critical/Important Areas	Citation
Order Decapoda, Infraorder Astacidea, Family Nephropidae				
<i>Homarus americanus</i>	American lobster	Cape Hatteras NC to Labrador Canada		ASFMC 2011
Order Decapoda, Infraorder Brachyura, Family Cancridae				
<i>Metacarcinus magister</i>	Dungeness crab	California to Alaska		Pauley et al. 1986



The Department of the Interior Mission

As the Nation's principal conservation agency, the Department of the Interior has responsibility for most of our nationally owned public lands and natural resources. This includes fostering sound use of our land and water resources; protecting our fish, wildlife, and biological diversity; preserving the environmental and cultural values of our national parks and historical places; and providing for the enjoyment of life through outdoor recreation. The Department assesses our energy and mineral resources and works to ensure that their development is in the best interests of all our people by encouraging stewardship and citizen participation in their care. The Department also has a major responsibility for American Indian reservation communities and for people who live in island territories under U.S. administration.