



**Proposed
Wave Energy Technology
Project**

MARINE CORPS BASE HAWAII, KANEOHE BAY, HAWAII

Department of the Navy

January 2003

DEPARTMENT OF DEFENSE
DEPARTMENT OF THE NAVY

FINDING OF NO SIGNIFICANT IMPACT FOR THE PROPOSED WAVE ENERGY
TECHNOLOGY TEST PROJECT AT MARINE CORPS BASE HAWAII, KANEOHE BAY,
OAHU, HAWAII

Pursuant to Section 102(2)(c) of the National Environmental Policy Act (NEPA) of 1969 and the Council of Environmental Quality regulations (40 CFR Parts 1500-1508) implementing the procedural provisions of NEPA, the Department of the Navy gives notice that an Environmental Assessment (EA) has been prepared, and that an Environmental Impact Statement is not required for the proposed installation and testing of a Wave Energy Technology project at Marine Corps Base Hawaii, Kaneohe Bay (MCBH Kaneohe Bay).

The Navy proposes the phased installation and operational testing of up to six Wave Energy Conversion (WEC) buoys off of North Beach at MCBH Kaneohe Bay, over a two to five year period. Operational testing of the buoys at MCBH Kaneohe Bay would provide data to validate the WEC technology developed by Ocean Power Technologies, Inc. This innovative, non-polluting energy technology, if demonstrated to be efficient, reliable, and cost-effective, could be used to provide supplemental electrical power to suitable coastal Department of Defense sites. Congressional appropriation language stipulates that this testing is to occur in Hawaii.

The EA evaluates and compares the potential environmental impacts of: (1) the Proposed Action, which is to conduct field tests of the WEC buoy system at North Beach, MCBH Kaneohe Bay; (2) an alternative site at Pearl Harbor; and (3) a No Action alternative. After considering the alternatives for the Proposed Action, the Pearl Harbor site was rejected because it has only a minimal wave energy environment and would not adequately meet the objectives of the project. The No Action alternative (i.e., not testing the WEC system in Hawaii) would not meet any of the objectives, and, therefore, was also rejected.

The first two buoys, to be installed no earlier than Spring 2003, would be anchored in about 100 feet (30.5 meters) of water at a distance from shore of approximately 3,900 feet (1,189 meters). Mechanical energy generated from the up and down motion of the buoy would be converted into electrical energy. The power would be transmitted to shore via an armored and shielded undersea power cable connected to a land transmission cable and routed to the existing MCBH Kaneohe Bay electrical grid system. Submerged equipment would be weighted down and secured to the seafloor with rock bolts and protective split pipe sufficient for maintaining system integrity in a 500-yr storm event. The land cable would be elevated above grade by a pedestal support system across sensitive areas of the Mokapu Burial Area. Each WEC buoy is expected to produce an average of 20 kW of power (sufficient to power approximately four to six typical, single-family residences), with 40 kW as the peak output for each buoy.

Ten potentially affected resources were identified for this project and none were found to be significantly impacted by the proposed installation and operational testing of the WEC buoy and ancillary equipment. These resources are: shoreline physiography, oceanographic conditions, marine biological resources, terrestrial biological resources, land and marine resource use

compatibility, cultural resources, infrastructure, recreation, public safety, and visual resources. Installation procedures would be designed to minimize impacts to living coral and benthic communities by avoiding areas of rich biological diversity and high coral coverage. The undersea cable would be laid with adequate tension to follow the contour of the seafloor and to resist forming loops that could otherwise entangle marine mammals. Entrapment of marine mammals and sea turtles within the buoy is unlikely because the interior of the structure is without obstructions, sharp edges, or corners and the opening in the bottom provides a path for ready egress.

Potential impacts on marine biota from operation of the WEC system would not be significant. Organisms sensitive to electric or magnetic fields may be able to detect emissions when very close to the undersea cable. However, the effects would be minor and temporary. In the unlikely event that damage to the cable causes an electrical fault or short, transient effects on marine organisms and divers (mild discomfort) may be experienced. Installation noise produced by drilling holes for installing rock bolts would be intermittent and of short duration. Operation of the WEC system is expected to produce a continuous acoustical output similar to low-grade noise associated with light to normal ship traffic. Noise from system installation or operational testing is not likely to adversely affect humpback whales, dolphins, and green sea turtles that may happen to be in the immediate area.

Growth of benthic organisms, such as corals and sponges, on the new substrate provided by the undersea cable, buoy anchor base, concrete moorings may end up benefiting the ecosystem. At close of the testing period, the Navy will meet with the Hawaii Department of Land and Natural Resources, U.S. Fish and Wildlife Service (USFWS), and the National Marine Fisheries Service (NMFS) to decide whether this equipment should be removed as planned or left in place. The buoys, equipment canister, and all onshore equipment would be removed at the close of the testing period.

In informal consultation under Section 7 of the Endangered Species Act, the USFWS and NMFS have both concurred with the Navy that the Proposed Action is not likely to adversely affect the threatened green sea turtle, endangered humpback whale, endangered hawksbill turtle, endangered Hawaiian monk seal or any other listed species. The taking of any marine mammal covered under the Marine Mammal Protection Act of 1972, as amended, is not likely to occur under the Proposed Action. Best Management Practices to avoid "taking" of threatened and endangered marine species that may enter the area during installation of the cable, buoys, and mooring will be developed and implemented.

There will be no significant impacts to recreation and public safety, although recreational activities in the immediate vicinity of the buoy array would be somewhat curtailed for the two to five-year test period. Access to the area around the buoy array will not be restricted, but signage will be installed advising of the dangers associated with the equipment. Potential hazards to mariners at the buoy array site would be mitigated by installing navigational aids and safety lights on the mast of the WEC buoys, filing a Notice to Mariners with the United States Coast Guard, and issuing additional public announcements. At the proposed distance from shore, impacts on the view plane by the buoy mast assembly (i.e., superstructure extending above the waterline) on each buoy would not be significant.

There would be no significant impact on land use. Under the Proposed Action a utility vault would be installed within the "clear zone" of a runway at MCBH Kaneohe Bay. The "clear zone" is an area adjacent to the runway with special restrictions to provide aircraft overrun areas and unobstructed visibility of airfield lighting. Since the vault would be in a low spot such that it would not be an obstruction, a waiver was approved by the Navy's airfield safety office.

Under Section 106 of the National Historic Preservation Act, the State Historic Preservation Officer has concurred with the Navy's determination that no historic properties would be affected.

The Hawaii Department of Business, Economic Development and Tourism, Office of Planning, has accepted under its Coastal Zone Management Program the Navy's Notice of Negative Determination.

Based on information gathered during preparation of the EA, the Navy finds that the proposed phased installation and operational testing of up to six WEC buoys at MCBH Kaneohe Bay, Oahu, Hawaii will not significantly impact human health or the environment. No significant socioeconomic impacts are anticipated, and there should be no disproportionately high and adverse human health or environmental effects from the Proposed Action on minority or low-income populations or children. There will be no cumulative impacts from the Proposed Action.

The Environmental Assessment addressing this action may be obtained from: Commander, Pacific Division, Naval Facilities Engineering Command (PACNAVFACENGCOM), 258 Makalapa Dr., Suite 100, Pearl Harbor, Hawaii 96860-3134. Attention: Ms. Connie Chang (PLN231), telephone (808) 471-9338, facsimile transmission (808) 474-5909. A limited number of the EA on compact disc is available to fill single-unit requests.

4/10/03

Ronald E. Tickle

Date

Ronald E. Tickle
Head, Operational Environmental Compliance and Planning Branch
Environmental Readiness Division (OPNAV N45)
Deputy Chief of Naval Operations (Logistics)

4/15/03

J.C. McABEE

Date

J.C. McABEE
Brigadier General, U.S. Marine Corps
Commanding General, Marine Corps Base Hawaii

COVER SHEET

Proposed Action: Installation and Operational Testing of Wave Energy Converter Buoys at Marine Corps Base Hawaii, Kaneohe Bay, Hawaii

Lead Agency: Department of the Navy

Coordinating Agency: Pacific Division, Naval Facilities Engineering Command

Contact: Mr. Gary Kasaoka, PLN231GK
PACNAVFACENGCOM
258 Makalapa Dr STE 100
Pearl Harbor, Hawaii 96860-3134
Telephone (808) 471-9338; Fax (808) 474-5909

This Environmental Assessment (EA) evaluates the potential environmental impacts of the proposed phased installation and operational testing of up to six Wave Energy Conversion (WEC) buoys off North Beach at Marine Corps Base Hawaii (MCBH) Kaneohe Bay (the Proposed Action). The EA has been prepared in accordance with the National Environmental Policy Act of 1969 (NEPA), 42 USC §4321 et seq.; regulations promulgated by the Council on Environmental Quality (CEQ) (40 CFR §§1500-1508); Chief of Naval Operations Instruction (OPNAVINST 5090.1B CH-2); and U.S. Marine Corps Order (MCO P5090.2A).

In addition to the Proposed Action, two alternatives were evaluated: No Action, where the wave energy technology test would not be implemented in Hawai'i, and an alternative site at a location outside the entrance to Pearl Harbor, Hawai'i.

The potential impacts of each alternative were analyzed for the following resources/issues: shoreline physiography, oceanographic conditions, marine biological resources, terrestrial biological resources, land and marine resource use compatibility, cultural resources, infrastructure, recreation, public safety, and visual resources. The analyses indicate that there would be no impacts from the No Action alternative, and that the potential impacts from having the project at MCBH Kaneohe Bay or at the Pearl Harbor site would be similar and not significant for the following areas: coral and benthic communities, potential entanglement of marine life with the undersea cable, potential entrapment of marine mammals and sea turtles within the buoy, electromagnetic radiation, potential electrical leakage, installation and operational noise, and views. There would be only temporary impacts to recreation and public safety at North Beach, in areas not currently restricted by MCBH Kaneohe Bay in the vicinity of the buoy array. No cumulative impacts from the WET (Wave Energy Technology) test would occur.

The Navy has completed informal consultation under Section 7 of the Endangered Species Act (ESA) with the U.S. Fish and Wildlife Service and the National Marine Fisheries Service regarding threatened and endangered species at the project area off MCBH Kaneohe Bay. The Navy also consulted with the State Historic Preservation Officer (SHPO), native Hawaiian organizations, and some individuals known to attach religious and cultural significance to that part of the base. Informal consultation with SHPO was carried out under Section 106 of the National Historic Preservation Act (NHPA) and its implementing regulations in 36 CFR Part 800.

Should the Pearl Harbor site be chosen for the project instead of the MCBH Kaneohe Bay location, the Navy would at that time initiate informal consultation under ESA and NHPA for siting the project at Pearl Harbor.

Table of Contents

ACRONYMS AND ABBREVIATIONS..... viii

EXECUTIVE SUMMARY ES-1

CHAPTER 1

PURPOSE OF AND NEED FOR THE PROPOSED ACTION

1.1	Proposed Action.....	1-1
1.2	Need for the Action.....	1-1
1.3	Objectives of the Action	1-2
1.4	Scope of This Environmental Analysis.....	1-3
1.4.1	Agency Scoping	1-3
1.4.2	Issues Studied in Detail.....	1-3
1.5	Decisions That Must Be Made.....	1-5
1.6	Applicable Legal and Regulatory Requirements and Coordination	1-5
1.6.1	Legal Requirements	1-5
1.6.1.1	NEPA of 1969, as amended (42 USC §4321 <i>et seq.</i>)	1-6
1.6.1.2	Clean Water Act (CWA) of 1977, as amended (33 USC §§1251–1387 <i>et seq.</i>).....	1-6
1.6.1.3	Rivers and Harbors Act (33 USC §403)	1-6
1.6.1.4	Coastal Zone Management Act (CZMA) of 1972 (16 USC §§1451–1465 <i>et seq.</i>).....	1-6
1.6.1.5	Endangered Species Act (ESA) of 1973 (16 USC §§1531–1544 <i>et seq.</i>).....	1-7
1.6.1.6	Fish and Wildlife Coordination Act (FWCA) of 1934, as amended (16 USC §§661–666[c] <i>et seq.</i>).....	1-7
1.6.1.7	Magnuson-Stevens Fishery Conservation and Management Act (16 USC §1801 <i>et seq.</i>)	1-7
1.6.1.8	Marine Mammal Protection Act (MMPA) of 1972, as amended (16 USC §§1361–1421(h) <i>et seq.</i>)	1-8
1.6.1.9	Migratory Bird Treaty Act (MBTA) of 1918, as amended (16 USC §§703– 712 <i>et seq.</i>).....	1-8
1.6.1.10	National Historic Preservation Act (NHPA) of 1966 (16 USC §470 <i>et seq.</i>).....	1-8
1.6.1.11	Native American Graves Protection and Repatriation Act (NAGPRA) of 1990 (25 USC §3001).....	1-8
1.6.1.12	EO 13089, Coral Reef Protection (63 FR 32701).....	1-9
1.6.1.13	EO 13186, Responsibilities of Federal Agencies to Protect Migratory Birds (16 USC §§ 703–711) (66 FR 3853)	1-9
1.6.1.14	EO 12898, Environmental Justice.....	1-9

1.6.1.15	EO 13045, Protection of Children from Environmental Health Risks and Safety Risks	1-10
1.6.1.16	EO 13123, Greening the Government Through Efficient Energy Management (65 FR 24595).....	1-10
1.6.2	Regulatory Requirements.....	1-10
1.6.3	Coordination Requirements	1-11
1.7	Consistency With Land Use Plans, Policies, and Controls.....	1-11

CHAPTER 2
ALTERNATIVES INCLUDING THE PROPOSED ACTION

2.1	Introduction.....	2-1
2.2	Process Used to Formulate the Alternatives	2-1
2.3	Alternatives Considered but Eliminated From Detailed Study.....	2-2
2.3.1	PMRF (Makaha Point, Kaua‘i).....	2-5
2.3.2	PMRF (Nohili Point, Kaua‘i).....	2-5
2.3.3	Bellows AFS (Waimanalo, O‘ahu).....	2-6
2.4	Description of Proposed Alternatives	2-7
2.4.1	Alternative A: Proposed Action.....	2-7
2.4.1.1	General Description and Site Selection Factors.....	2-7
2.4.1.2	WEC System Components.....	2-8
2.4.1.3	Installation Procedures.....	2-11
2.4.1.4	System Monitoring and Protection	2-13
2.4.1.5	System Removal	2-14
2.4.2	Alternative B: Pearl Harbor	2-14
2.4.2.1	General Description and Site Selection Factors.....	2-14
2.4.2.2	WEC System Components.....	2-15
2.4.2.3	Installation Procedures.....	2-15
2.4.2.4	System Monitoring.....	2-16
2.4.2.5	System Removal	2-16
2.4.3	Alternative C: No Action	2-16
2.5	Summary of the Predicted Environmental Effects of the Proposed Alternatives.....	2-16

CHAPTER 3
AFFECTED ENVIRONMENT

3.1	Introduction.....	3-1
3.2	Description of Relevant Affected Resources – Alternative A: Proposed Action	3-1
3.2.1	Shoreline Physiography	3-1
3.2.2	Oceanographic Conditions.....	3-1
3.2.3	Marine Biological Resources.....	3-2

3.2.3.1	Sand-Boulder Zone	3-3
3.2.3.2	Sand Channel Zone	3-3
3.2.3.3	Reef Flat Zone.....	3-4
3.2.3.4	Escarpment Zone	3-4
3.2.3.5	Deep Reef Platform Zone	3-5
3.2.3.6	Undercut Ledges	3-5
3.2.3.7	Threatened or Endangered Species.....	3-5
3.2.3.8	Commercial, Subsistence, and Recreational Species.....	3-6
3.2.3.9	Marine Mammals	3-6
3.2.4	Terrestrial Biological Resources.....	3-6
3.2.4.1	Flora	3-6
3.2.4.2	Fauna.....	3-6
3.2.4.3	Threatened or Endangered Species.....	3-7
3.2.5	Land and Marine Resource Use Compatibility.....	3-7
3.2.6	Cultural Resources	3-8
3.2.7	Infrastructure.....	3-9
3.2.8	Recreation	3-9
3.2.9	Public Safety	3-10
3.2.10	Visual Resources.....	3-11
3.3	Description of Relevant Affected Resources – Alternative B: Pearl Harbor.....	3-11
3.3.1	Shoreline Physiography	3-11
3.3.2	Oceanographic Conditions.....	3-11
3.3.3	Marine Biological Resources.....	3-12
3.3.3.1	Channel Bottom	3-12
3.3.3.2	Channel Slope	3-13
3.3.3.3	Channel Wall	3-13
3.3.3.4	Fossilized Reef Platform.....	3-13
3.3.3.5	Sand-Rubble Zone	3-14
3.3.3.6	Threatened or Endangered Species.....	3-14
3.3.3.7	Commercial and Recreational Species.....	3-14
3.3.3.8	Marine Mammals	3-14
3.3.4	Terrestrial Biological Resources.....	3-15
3.3.4.1	Flora	3-15
3.3.4.2	Fauna.....	3-15
3.3.4.3	Threatened or Endangered Species.....	3-15
3.3.5	Land and Marine Resource Use Compatibility.....	3-16
3.3.6	Cultural Resources	3-16
3.3.7	Infrastructure.....	3-16
3.3.8	Recreation	3-16
3.3.9	Public Safety	3-17
3.3.10	Visual Resources.....	3-17

3.4	Description of Relevant Affected Resources – Alternative C: No Action	3-17
3.5	Description of Relevant Non-Affected Resources – Alternative A: Proposed Action.....	3-18
3.5.1	Climate and Air Quality.....	3-18
3.5.2	Currents and Tides	3-18
3.5.3	Tsunamis	3-19
3.5.4	Hurricanes	3-19
3.5.5	Geology and Soils.....	3-19
3.5.6	Water Quality.....	3-20
3.5.7	Noise	3-20
3.5.8	Electromagnetic Radiation (EMR)	3-20
3.5.9	Ordnance Material	3-21
3.6	Description of Relevant Non-Affected Resources – Alternative B: Pearl Harbor	3-21
3.6.1	Climate and Air Quality.....	3-21
3.6.2	Currents and Tides	3-21
3.6.3	Tsunamis.....	3-21
3.6.4	Hurricanes	3-21
3.6.5	Geology and Soils.....	3-22
3.6.6	Water Quality.....	3-22
3.6.7	Noise	3-22
3.6.8	Electromagnetic Radiation.....	3-22
3.6.9	Ordnance Material	3-23
3.7	Relevant Non-Affected Resources –Alternative C: No Action	3-23

CHAPTER 4
ENVIRONMENTAL CONSEQUENCES

4.1	Introduction.....	4-1
4.2	Predicted Effects on Relevant Affected Resources From Alternative A: Proposed Action.....	4-1
4.2.1	Predicted Effects on Shoreline Physiography.....	4-1
4.2.2	Predicted Effects on Oceanographic Conditions	4-2
4.2.3	Predicted Effects on Marine Biological Resources	4-2
4.2.3.1	Installation of the Undersea Cable.....	4-3
4.2.3.2	Installation of the Buoy.....	4-4
4.2.3.3	Operation of the WEC System.....	4-4
4.2.3.4	Removal of the WEC System	4-8
4.2.4	Predicted Effects on Terrestrial Biological Resources	4-8

4.2.5	Predicted Land and Marine Resource Use Compatibility Effects	4-8
4.2.6	Predicted Effects on Cultural Resources.....	4-9
4.2.7	Predicted Effects on Infrastructure	4-10
4.2.8	Predicted Effects on Recreation.....	4-10
4.2.9	Predicted Effects on Public Safety.....	4-11
4.2.10	Predicted Effects on Visual Resources	4-11
4.3	Predicted Effects on Relevant Affected Resources From Alternative B: Pearl Harbor	4-12
4.3.1	Predicted Effects on Shoreline Physiography.....	4-12
4.3.2	Predicted Effects on Oceanographic Conditions	4-12
4.3.3	Predicted Effects on Marine Biological Resources	4-12
4.3.3.1	Installation of the Undersea Cable.....	4-13
4.3.3.2	Installation of the Buoy.....	4-13
4.3.3.3	Operation of the WEC System.....	4-14
4.3.3.4	Removal of the WEC System	4-14
4.3.4	Predicted Effects on Terrestrial Biological Resources	4-15
4.3.5	Predicted Land and Marine Resource Use Compatibility Effects	4-15
4.3.6	Predicted Effects on Cultural Resources.....	4-15
4.3.7	Predicted Effects on Infrastructure	4-16
4.3.8	Predicted Effects on Recreation.....	4-16
4.3.9	Predicted Effects on Public Safety.....	4-16
4.3.10	Predicted Effects on Visual Resources	4-17
4.4	Predicted Effects On Relevant Affected Resources From Alternative C: No Action.....	4-17
4.5	Energy Requirements and Conservation Potential	4-17
4.6	Cumulative Impacts	4-17
4.6.1	Alternative A: Proposed Action.....	4-17
4.6.2	Alternative B: Pearl Harbor Alternative	4-18
4.6.3	Alternative C: No Action	4-18
4.7	Irreversible and Irretrievable Commitments of Resources	4-18
4.8	Unavoidable Adverse Effects	4-18
4.9	Conclusion	4-18

CHAPTER 5
LIST OF PREPARERS 5-1

CHAPTER 6
REFERENCES..... 6-1

Appendices

Appendix A A-1 Copies of Scoping Letters for the Proposed Action
 A-2 Agency Responses for the Proposed Action
 A-3 CZMA Negative Determination Notice for the Proposed Action
 A-4 ESA Section 7 Correspondence for the Proposed Action
 A-5 NHPA Section 106 Correspondence for the Proposed Action

Appendix B B-1 Copies of Scoping Letters for the Pearl Harbor Site Alternative
 B-2 Agency Responses for the Pearl Harbor Site Alternative
 B-3 CZMA Negative Determination Notice for the Pearl Harbor Site Alternative

Appendix C Navy Responses to Agency Comments on the Draft EA

Appendix D “Marine Natural Resources Insert for the WET EA.” July 2002. Prepared by Steve Smith, PACDIV, Pearl Harbor, O’ahu, Hawai‘i.

Appendix E *Coastal And Oceanographic Setting For WEC Buoy Site Marine Corps Base Hawaii.* May 2002. Sea Engineering Inc.

Appendix F *Wave Energy Technology (WET) Project Environmental Impacts of Selected Components.* July 2002. Sound & Sea Technology.

Appendix G Material Safety Data Sheets

Appendix H *Wave Energy Technology (WET) Marine Corps Base Hawaii Marine Environmental Assessment.* May 2002. Marine Research Consultants.

Appendix I *Marine Public Safety and Recreational Uses Report for the Wave Energy Technology (WET) Test Environmental Assessment (EA).* May 2002. Ocean Recreation Consultant, John Clark.

Appendix J *Wave Energy Conversion (WEC) Buoy Impact on a Wave Field.* May 2002. Sea Engineering Inc.

List of Tables

Table 1-1 Summary of Possible Government Permits and Consultations 1-11

Table 2-1 Site Selection Matrix..... 2-3

Table 2-2 Comparison of Predicted Environmental Effects 2-17

Table 4-1 Comparison of Predicted Environmental Effects 4-19

List of Figures

Figure 1-1 Regional Location..... 1-13

Figure 1-2 Project Vicinity, North Beach, MCBH Kaneohe Bay 1-15

Figure 2-1 Alternative Sites Considered..... 2-23

Figure 2-2 Undersea Cable Route and Wave Buoy Array, North Beach,
 MCBH Kaneohe Bay 2-25

Figure 2-3 Land Transmission Cable Route, North Beach, MCBH Kaneohe Bay 2-27

Figure 2-4 Buoy, Anchor, and Canister Configuration 2-29

Figure 2-5 Cross-section of WEC Buoy 2-31

Figure 2-6a Grouted Rock Bolt 2-33

Figure 2-6b Cable Sled 2-33

Figure 2-7 Proposed 4 Point Boat Mooring Location 2-35

Figure 2-8 Work Boat Mooring Configuration 2-37

Figure 2-9 Cable Landing and Staging Area, North Beach, MCBH Kaneohe Bay 2-39

Figure 2-10 Location of Cable Beach Anchor, North Beach, MCBH Kaneohe Bay 2-41

Figure 2-11 Undersea Cable Route and Wave Buoy Array, Pearl Harbor 2-43

Figure 3-1 WET Buoy/Cable Route Benthic Zonation, North Beach,
 MCBH Kaneohe Bay 3-25

Figure 3-2 Benthic Zones, North Beach, MCBH Kaneohe Bay..... 3-27

Figure 3-3 View to the North, North Beach, MCBH Kaneohe Bay 3-29

Figure 3-4 Land Use Compatibility and Recreation, North Beach,
 MCBH Kaneohe Bay 3-31

Figure 3-5 View to the Northwest, North Beach, MCBH Kaneohe Bay 3-33

Figure 3-6 Pearl Harbor Alternative Land Cable Route 3-35

Figure 3-7 Pearl Harbor Alternative Cable Landing Site 3-37

Acronyms and Abbreviations

°	degree
A	amperes
A/m	amps per meter
AC	alternating current
ACHP	Advisory Council on Historic Preservation
AFB	Air Force Base
AFS	Air Force Station
APE	area of potential effect
AUVs	Autonomous Underwater Vehicles
dB	decibel(s)
BMPs	Best Management Practices
C	Celsius
CAA	Clean Air Act
CEQ	Council on Environmental Quality
CFR	Code of Federal Regulations
cm	centimeter(s)
CRAMP	Coral Reef Assessment and Monitoring Program
CWA	Clean Water Act of 1977
CZM	Coastal Zone Management
CZMA	Coastal Zone Management Act of 1972
CZMP	Coastal Zone Management Program
DA	Department of the Army
DAR	Division of Aquatic Resources (State of Hawaii, Department of Land and Natural Resources)
dB	decibels
DBEDT	Department of Business, Economic Development and Tourism (State of Hawaii)
DC	direct current
DGPS	Differential Global Positioning System
DLNR	Department of Land and Natural Resources (State of Hawaii)
DoD	Department of Defense
DOH	Department of Health (State of Hawaii)
EA	Environmental Assessment
EFH	Essential Fish Habitat
EIS	Environmental Impact Statement
EM	electric and magnetic
EMR	electromagnetic radiation

EO	Executive Order
EPA	Environmental Protection Agency
ESA	Endangered Species Act of 1973
ESQD	explosive safety quantity distance
F	Fahrenheit
FAD	fish aggregating device
FIP	Federal Implementation Plan
FMP	Fisheries Management Plan
FONSI	Finding of No Significant Impact
ft	feet
FWCA	Fish and Wildlife Coordination Act of 1934
FWPCA	Federal Water Pollution Control Act of 1948
GPS	Global Positioning System
h	hour(s)
HAPC	Habitat Areas of Particular Concern
HAR	Hawaii Administrative Rules
HECO	Hawaiian Electric Company
HERF	EMR hazards to fuel
HERO	EMR hazards to ordnance
HERP	EMR hazards to personnel
HFD	Honolulu Fire Department
HRS	Hawaii Revised Statutes
in	inches
ICRMP	Integrated Cultural Resources Management Plan
INRMP	Integrated Natural Resources Management Plan
kg	kilogram(s)
km	kilometer(s)
km/h	kilometer(s) per hour
kW	kilowatt(s)
kV	kilovolt(s)
kVA	kilovolt-amperes
lb	pound(s)
Ldn	day-night equivalent sound levels in units of the decibel or dB
m	meter(s)
MBA	Mokapu Burial Area
MBTA	Migratory Bird Treaty Act of 1918
MCBH	Marine Corps Base Hawaii
mi	mile(s)
MILCON	military construction

mm	millimeter(s)
MMPA	Marine Mammal Protection Act of 1972
MOA	Memorandum of Agreement
MOU	Memorandum of Understanding
ms	millisecond(s)
MSDS	Material Safety Data Sheet
mV	millivolt(s)
mV/m	millivolt per meter
MV	megavolt(s)
MVA	megavolt-amperes
mW	milliwatt(s)
NAF	Non-Appropriated Fund
NAGPRA	Native American Graves Protection and Repatriation Act
NAAQS	National Ambient Air Quality Standards
NAVMAG	Naval Magazine
Navy	U.S. Department of the Navy
NDSA	Naval Defensive Sea Area
NEPA	National Environmental Policy Act of 1969
NHPA	National Historic Preservation Act of 1966
NMFS	National Marine Fisheries Service
NRHP	National Register of Historic Places
OA/FA	oil-cooled ambient/forced air
ONR	Office of Naval Research
OPNAVINST	Office of the Chief of Naval Operations Instruction
OPT	Ocean Power Technologies, Inc.
PA	Programmatic Agreement
PACDIV	Pacific Division (U.S. Navy)
PAR	Precision Approach Radar
PBZ	Prohibited Buffer Zone
PMRF	Pacific Missile Range Facility
PVC	polyvinyl chloride
s	second(s)
SCUBA	self-contained underwater breathing apparatus
SHPO	State Historic Preservation Officer
SIP	State Implementation Plan
sq	square
State	State of Hawaii
U.S.	United States
USACE	United State Army Corps of Engineers

USC	United States Code
USCG	United States Coast Guard
USFWS	United States Fish and Wildlife Service
v	volt(s)
W	watt(s)
WEC	Wave Energy Conversion
WET	Wave Energy Technology
WPRFMC	Western Pacific Regional Fishery Management Council
yd	yard(s)

Executive Summary

EXECUTIVE SUMMARY

PURPOSE AND NEED

The Office of Naval Research proposes the phased installation and operational testing of Wave Energy Conversion (WEC) buoys off North Beach, Marine Corps Base Hawaii, Kaneohe Bay (MCBH Kaneohe Bay). This action is being proposed to test wave energy as a renewable, non-polluting power source. Department of Defense (DoD) installations are vulnerable during times of national conflict due to their reliance on conventional fuels for electrical power generation. Coastal DoD sites with suitable wave energy potential could obtain supplemental power using wave energy if it can be demonstrated to be efficient, reliable, and cost-effective. Testing is needed to obtain operational data to validate the WEC technology developed by Ocean Power Technologies, Inc. The Congressional appropriation to conduct this test stipulates that testing is to occur in Hawai'i, which has coastal locations with high wave energy potential.

The objectives of the Proposed Action are the following:

Objective 1. Conduct the test in a high wave energy density environment, characterized by an average annual wave height of 3 feet (ft) or 1.0 meter (m) (minimum) to 5 ft or 1.5 m (optimum), which is a likely characteristic of the environment for future operational use of the WEC technology at other locations.

Objective 2. Challenge the system under variable conditions, such as winter storms, to investigate the survivability of the system.

Objective 3. Collect statistically significant data sets to validate assumptions and findings. Increasing the period of collection, e.g., up to five years, would increase the likelihood of obtaining statistically significant data sets for various test parameters, such as seasonal changes and their effects on the system.

Objective 4. Observe the effect on system performance when more than one buoy is present.

Objective 5. Use a test site for the system that minimizes the costs of installation, operations, and maintenance.

Objective 6. Minimize the risk of system failure, to optimize the collection of data, by maximizing the survivability of the system.

PROPOSED ACTION AND ALTERNATIVES

WEC system components include the buoy, anchor base, hydraulic lines, equipment canister, undersea cable, land cable, utility vault to house the connection of the undersea and land cables, and equipment shelter. In addition to the WEC system, the project proposes the installation of four mooring clumps within the buoy field for anchoring workboats. Installation and operational testing would occur over a two- to five-year time period with the first two buoys installed no earlier than the beginning of calendar year 2003.

Alternative A: Proposed Action. This alternative is the phased installation and operational testing of up to six WEC buoys off North Beach, MCBH Kaneohe Bay. The undersea cable would enter the water east of the main runway and extend approximately 3,900 ft (1,189 m) to the approximate depth of 100 ft (30.5 m), the site of the proposed buoy array. On shore, the utility vault would be located above the high water mark and Battery French, located on a hillside behind the Officers' Family Housing area, would serve as the equipment shelter. The land cable would be secured to the utility vault, encased in a conduit, and be elevated on pedestals along its route to Battery French. This site location meets all of the project objectives.

Alternative B: Pearl Harbor. This alternative is the phased installation and operational testing of up to six WEC buoys outside the entrance channel to Pearl Harbor. The undersea cable (approximately 12,000 ft [3,658 m]) would be installed on the western side of the Pearl Harbor entrance channel along the junction of the channel slope and bottom. The proposed buoy array would be in the open coastal waters outside the channel in the approximate area of the 100-ft (30.5-m) contour. The cable landing site would be located on the shoreline adjacent to Building 562, just northeast of the Iroquois Point housing. The utility vault would be placed on the lawn of Building 562, which would serve as the equipment shelter. This site meets the project objectives but would provide only a minimal wave energy environment to test the WEC technology.

Alternative C: No Action. The No Action alternative would not implement the proposed Wave Energy Technology (WET) test in Hawai'i. The operational test data would not be obtained and the objectives of the WET test would not be achieved.

ENVIRONMENTAL CONSEQUENCES

This document evaluates and compares the potential environmental impacts of the three alternatives. The affected resources or issues analyzed in detail include: shoreline physiography, oceanographic conditions, marine and terrestrial biological resources, land and marine resource use compatibility, cultural resources, infrastructure, recreation, public safety, and visual resources. The findings for Alternatives A and B are summarized below. Alternative C: No Action would not implement the proposed WET test in Hawai'i. Therefore, no affected resources or impacts to affected resources would result from this alternative.

Shoreline Conditions. Minimal impacts would occur to shoreline conditions at North Beach, MCBH Kaneohe Bay and the Pearl Harbor site due to the proposed installation. The WEC system would not alter currents or wave directions, and there would be no effects on shoreline erosion or change in sand deposition patterns. At the end of the test period, land equipment would be removed.

Oceanographic Conditions. No impacts on oceanographic conditions are expected. Implementing the WET test would not affect wave scattering and energy absorption.

Marine Biological Resources. Minor impacts would occur to marine biological resources along the cable route and buoy array site at North Beach, MCBH Kaneohe Bay, and the Pearl Harbor site. Installation of the WEC system at the two sites would avoid areas of rich biological diversity and high percentages of coral coverage. No Habitat Areas of Particular Concern (HAPC) have been identified or designated at either site.

Marine species listed under the Endangered Species Act as threatened or endangered and that are known to occur at North Beach include the green sea turtle, hawksbill turtle, Hawaiian monk seal, and humpback whale. The U.S. Fish and Wildlife Service (USFWS) and National Marine Fisheries Service (NMFS) concur with the Navy that the Proposed Action is not likely to adversely affect threatened and endangered species under their jurisdictions. The taking of marine mammals protected under the Marine Mammal Protection Act (MMPA) is unlikely during the installation and operation of the WEC system. The potential growth of benthic organisms such as corals on the WEC cable and anchor during the test period would be a beneficial impact.

A biological monitoring plan for fish and benthic organisms will be developed, as part of the Navy's Best Management Practices (BMPs). In consultation with the NMFS, USFWS and State of Hawaii (State) Department of Land and Natural Resources, Division of Aquatic Resources (DAR), the Navy would determine at the end of the test period whether equipment installed on the seafloor (i.e., cable, buoy anchor system from the universal joint down, mooring clump base and anchoring system) should be removed or left in place. All other WEC equipment such as the buoys and equipment canisters would be removed following completion of the test.

The following potential effects from entanglement, entrapment, electromagnetic radiation (EMR), electrical current leakage, heat release, and noise from installation and operation of the WEC system would be similar for the MCBH Kaneohe Bay and Pearl Harbor sites.

- **Entanglement.** Entanglement would be a minimal concern, as installation would occur in shallow water with adequate tension to allow the cable to resist forming loops and contour to the seafloor. Divers would inspect the cable route once it is in place. There would be no risk of entanglement once the cable is rock-bolted to the seafloor. Mooring lines and anchor chains for the four mooring clumps would be pulled taut during installation, minimizing risks of entanglement.

- **Entrapment.** There is minimal potential for entrapment of marine mammals or sea turtles within the buoy since the interior of the structure is free of obstructions, sharp edges, or corners. The size of the opening in the bottom of the WEC buoy provides a ready egress path. As part of the Navy's systems monitoring plan, the system will be examined for entrapment of marine species.
- **EMR.** The small scale and limited area of disturbance indicate that impacts from EMR on marine organisms would be minor and temporary. Impacts of EMR on marine organisms can be expected to range from no impact to avoidance (for bottom-dwelling organisms only) of the vicinity of the WEC cable.
- **Electrical Leakage.** In the unlikely event that damage to the cable causes an electrical fault or short, transient effects on marine organisms and divers (mild discomfort) could occur. Electroreceptive species would likely detect the field and be diverted away from the vicinity of the fault during the short period that the ground fault system actuates.
- **Heat Release.** There would be no impacts to marine life from potential heat release.
- **Noise.** Installation noise produced by drilling holes for rock bolts would be localized, intermittent, and of short duration. Operation of the WEC system is expected to produce a continuous acoustic output similar to that of ship traffic. It is unlikely that noise from system installation or operation would have adverse effects on humpback whales, dolphins, and green sea turtles.

Terrestrial Biological Resources. No Federally listed threatened or endangered terrestrial species occur at the North Beach, MCBH Kaneohe Bay, and Pearl Harbor sites. The land cable routes would traverse environmentally non-sensitive areas, and existing structures would be used as equipment shelters.

Land and Marine Resource Use Compatibility. Land use incompatibilities are not anticipated at North Beach, MCBH Kaneohe Bay, and the Pearl Harbor site where sitting on military property minimizes security risks. At Pearl Harbor, the offshore component of the project is located within restricted waters. At MCBH Kaneohe Bay, incompatible marine resource uses where the buoy array would be installed include limited subsistence fishing, commercial fishing, and recreational boating and fishing.

The proposed WET test project would not interfere with mission operations at MCBH Kaneohe Bay or the Pearl Harbor site.

Cultural Resources. Although the land based segment of the WEC system would be sited within the Mokapu Burial Area, the State Historic Preservation Officer (SHPO) concurred with the Navy that the project would have no effect on historic properties. There would be no effect on cultural resources at the Pearl Harbor site.

Infrastructure. There would be no adverse impacts to existing infrastructure resulting from the installation and operation of the WEC system at North Beach, MCBH Kaneohe Bay, or at the Pearl Harbor site.

Recreation. At MCBH Kaneohe Bay, there would be no impacts on recreation within the 500-yd (457-m) buffer zone. There would be impacts to recreational activities presently conducted outside the 500-yd (457-m) buffer zone in the vicinity of the buoy array for the two- to five-year duration of the WET test, but these impacts would not be significant. At the Pearl Harbor site, there would be no impacts to recreation because the area is off-limits to public access and recreational activities.

Public Safety. At MCBH Kaneohe Bay, there would be no impacts on public safety within the 500-yd (457-m) buffer zone. There would be potential impacts to public safety outside the 500-yd (457-m) buffer zone due to the presence of the buoy array over the two- to five-year duration of the WET test. The potential hazards will be mitigated by providing appropriate markings on the buoys, implementing a plan to respond to system failures, and implementing communication procedures to increase public awareness of the WET system. At the Pearl Harbor site, there would be no impacts to public safety because the area is off-limits to public access.

Visual Resources. Impacts on scenic views would be minimal at both North Beach, MCBH Kaneohe Bay, and the Pearl Harbor site. Navigational aids from the buoys would extend approximately 30 ft (9 m) above sea level. At night, safety lights on the navigational aids would be visible in the distance.

Cumulative Impacts. No cumulative impacts are anticipated at the North Beach, MCBH Kaneohe Bay and Pearl Harbor sites.

Chapter 1

Purpose of and Need for the Proposed Action

CHAPTER 1

PURPOSE OF AND NEED FOR THE PROPOSED ACTION

This Environmental Assessment (EA) for the Wave Energy Technology (WET) test project was prepared in accordance with the National Environmental Policy Act of 1969 (NEPA), as amended, 42 United States Code (USC) §4321 *et seq.*; regulations of the Council on Environmental Quality (CEQ) (40 Code of Federal Regulations [CFR] §§1500–1508) implementing NEPA; *Environmental and Natural Resources Program Manual*, Chief of Naval Operations Instruction (OPNAVINST) 5090.1B, Chapter 2; and *Environmental Compliance and Protection Manual*, Chapter 12, Marine Corps Order P5090.2A.

Identified in this EA are the need for installation and operational testing of up to six Wave Energy Conversion (WEC) buoys off the coast of Hawai‘i for the WET project, existing environmental conditions at the proposed site and an alternative site, potential environmental impacts, and mitigation measures to avoid or minimize these potential impacts. The document provides the U.S. Department of the Navy (Navy) decision makers with information needed to determine whether to prepare an Environmental Impact Statement (EIS) or issue a Finding of No Significant Impact (FONSI).

1.1 PROPOSED ACTION

The Office of Naval Research (ONR) proposes the phased installation and operational testing of up to six WEC buoys off North Beach, Marine Corps Base Hawaii, Kaneohe Bay (MCBH Kaneohe Bay) (Figures 1-1 and 1-2). The project would occur over a two- to five-year time period, with the first two buoys installed no earlier than the beginning of calendar year 2003.

1.2 NEED FOR THE ACTION

The Navy is operating coastal facilities using electrical power from conventional diesel-powered generators. These facilities use fossil fuels that are subject to fluctuations in availability and price, and require relatively large storage/supply areas. Dependencies on fossil fuels make the operation of coastal Department of Defense (DoD) facilities vulnerable, particularly during times of national conflict. To reduce this vulnerability, alternative power sources are being sought and include the generation of supplemental power harnessed from the energy of waves. Coastal DoD sites with suitable wave energy potential could obtain supplemental power with this innovative, non-polluting power source if it can be demonstrated to be efficient, reliable, and cost-effective.

Previous to the Proposed Action, Ocean Power Technologies Inc. (OPT) developed and refined their power conversion technology under the Small Business Innovation Research program sponsored by ONR. Early efforts included investigating the feasibility of efficiently transforming

the mechanical energy in ocean waves into electrical power to be used by the Navy to recharge the batteries of Autonomous Underwater Vehicles (AUVs). A series of analyses and experiments led to preliminary design of a buoy-like WEC system that produced up to 1 kilowatt (kW) of electrical power. Subsequent efforts evaluated various technologies for efficiently converting wave energy on a large scale. A single first-generation WEC buoy deployed off Tuckerton, New Jersey, produced an average of 250 watts (W) of power. Further refinements to the technology resulted in a design for more efficient extraction of the energy from a wider range of wave conditions. The increase in efficiency resulted in expansion of the WEC's capability from AUVs recharging to mission-critical large power output. The Proposed Action would be the first deployment of a fully instrumented, full-scale buoy designed for large power output. Preliminary performance data gathered during this action would be used to base engineering models for operational availability and hydrodynamic analyses. In addition, this action would demonstrate the survivability and maintainability of the system.

The Proposed Action is needed to obtain operational data to validate the WEC technology developed by OPT. The Congressional appropriation to conduct this test stipulates that testing is to occur in Hawai'i, which has coastal locations with high wave energy potential.

1.3 OBJECTIVES OF THE ACTION

The objectives of the Proposed Action are as follows:

Objective 1. Conduct the test in a high wave energy density environment, characterized by an average annual wave height of 3 feet (ft) or 1.0 meter (m) (minimum) to 5 ft or 1.5 m (optimum), which is a likely characteristic of the environment for future operational use of the WEC technology at other locations.

Objective 2. Challenge the system under variable conditions, such as winter storms, to investigate the survivability of the system.

Objective 3. Collect statistically significant data sets to validate assumptions and findings. Increasing the period of collection, e.g., up to five years, would increase the likelihood of obtaining statistically significant data sets for various test parameters, such as seasonal changes and their effects on the system.

Objective 4. Observe the effect on system performance when more than one buoy is present.

Objective 5. Use a test site for the system that minimizes the costs of installation, operations, and maintenance.

Objective 6. Minimize the risk of system failure, to optimize the collection of data, by maximizing the survivability of the system.

1.4 SCOPE OF THIS ENVIRONMENTAL ANALYSIS

1.4.1 Agency Scoping

Scoping letters were forwarded to the following Federal and State of Hawai‘i agencies to solicit their comments regarding the Proposed Action and the Pearl Harbor alternative:

- United States (U.S.) Army Corps of Engineers (USACE),
- U.S. Department of Commerce – National Marine Fisheries Service (NMFS),
- U.S. Fish and Wildlife Service (USFWS),
- U.S. Coast Guard (USCG),
- State Department of Land and Natural Resources – Division of Aquatic Resources (DLNR-DAR),
- State Department of Business, Economic Development and Tourism (DBEDT), State Office of Planning, Coastal Zone Management Program (CZMP),
- State DLNR – Division of Boating and Ocean Recreation, and
- U.S. Air Force – Hickam Air Force Base.

Copies of the scoping letters and agency responses on the Proposed Action are provided in Appendix A, and on the Pearl Harbor alternative, in Appendix B.

Additionally, this EA provides agency comments on the Draft EA, along with the Navy's responses to these comments. These correspondences are provided in Appendix C.

1.4.2 Issues Studied in Detail

The scoping process, which included input by regulatory agencies listed above and MCBH Kaneohe Bay environmental staff, revealed that environmental concerns focus on the protection of marine biota and habitats, as well as preservation of cultural resources present within the project area. The potential issues and concerns are summarized below.

- **Shoreline Physiography**

Assess impacts to the shoreline caused by altered wave and current patterns that may result from installation of the buoys.

- **Installation and Anchorage Effects on Coral and Benthic Communities**

Evaluate impacts of the buoy anchors, moorings, and undersea cable on the substrate, including possible damage to coral communities should one or more of the buoys be cast adrift during winter storms.

- **Habitat Areas of Potential Concern**

Determine the presence of Habitat Areas of Particular Concern (HAPC) within the proposed project site. HAPC are a subset of Essential Fish Habitat (EFH), which are areas considered “rare, particularly susceptible to human-induced degradation, especially ecologically important, or located in an environmentally stressed area” (50 CFR 600.815(A)(9)).¹

- **Threatened and Endangered Species**

Evaluate the potential for adverse effects on threatened and endangered species within the proposed project site.

- **Marine Mammals and Marine Turtles**

Assess project impacts on marine mammals and marine turtles within the proposed project area.

- **Entanglement/Entrapment**

Assess whether the presence of WEC equipment and cables in the marine environment would pose a potential risk to marine life by entanglement with the cables or entrapment within the buoy.

- **Electromagnetic Radiation**

Analyze whether electric or magnetic fields created by the WET project have the potential to adversely impact marine life in the vicinity of the project.

- **Potential Electrical Current Leakage**

Assess the impacts of potential electrical current leakage from the undersea cable on marine biota.

- **Potential Heat Release**

Evaluate the potential for heat to be released by the generator contained in the equipment canister and by the undersea transmission cable, and the possible impact of heat release on marine biota.

- **Noise**

Assess the impacts of potential acoustic emissions from the system on marine biota.

- **Recreation**

Assess potential impacts to recreational users of the project area such as fishers, boaters, and self-contained underwater breathing apparatus (SCUBA) divers.

¹ NMFS EFH Web site <http://www.nmfs.noaa.gov/habitat/habitatprotection/essentialfishhabitat5.htm>; accessed July 25, 2002.

- **Public Safety**

Provide for public safety associated with the placement of the buoy array, and high voltage undersea and land based cables.

- **Visual Resources**

Assess visual impacts of placing the buoys off shore where nothing like it currently exists.

- **Cultural Resources**

Evaluate impacts to cultural resources within the proposed project area.

1.5 DECISIONS THAT MUST BE MADE

The ONR, as the action proponent, is responsible for the preparation of this EA in compliance with NEPA. ONR and MCBH Kaneohe Bay (the potential Host Installation) are responsible for ensuring that the project is executed in compliance with all applicable environmental laws and regulations including NEPA. Therefore, both agencies must make decisions based on the outcome of this EA.

The decisions to be made by the Navy are whether to:

- issue a FONSI;
- direct the preparation of an EIS for the Proposed Action; or
- take no action (i.e., do not proceed with the installation and testing of the WEC technology).

The decisions to be made by the Commanding General, MCBH Kaneohe Bay are whether to:

- endorse and co-sign the FONSI issued by the Navy or recommend the preparation of an EIS;
- approve installation and testing of the WEC system at North Beach, MCBH Kaneohe Bay.

1.6 APPLICABLE LEGAL AND REGULATORY REQUIREMENTS AND COORDINATION

1.6.1 Legal Requirements

Executive Orders² (EO) and Federal laws applicable to this project are described below.

² Executive Orders are regulations issued by the president, governor, or other chief executive and having the force of law.

1.6.1.1 NEPA of 1969, as amended (42 USC §4321 *et seq.*)

NEPA requires Federal agencies to prepare an EA or EIS for Federal actions that have the potential to significantly affect the quality of the human environment, including both natural and cultural resources. The Act establishes Federal agency procedures for preserving important aspects of the national heritage and enhancing the quality of renewable resources. This document has been prepared in compliance with NEPA and CEQ regulations (40 CFR §§1500–1508).

1.6.1.2 Clean Water Act (CWA) of 1977, as amended (33 USC §§1251–1387 *et seq.*)

The CWA is a compilation of decades of Federal water pollution control legislation. In 1987, the Act amended the Federal Water Pollution Control Act (FWPCA) requiring Federal agency consistency with state nonpoint source pollution abatement plans, and strengthening enforcement mechanisms and regulations for storm water runoff. Sections 401, 402, and 404 of the Act require permits for Proposed Actions that involve wastewater discharges or discharge of dredged or fill material into waters of the United States.

Wastewater discharges and discharge of dredged or fill material into waters of the U.S. would not occur with the testing of the WEC technology at either North Beach, MCBH Kaneohe Bay, or the Pearl Harbor site .

1.6.1.3 Rivers and Harbors Act (33 USC §403)

In accordance with Section 10 of the Rivers and Harbors Act, 33 USC §403, a Department of the Army (DA) permit is required for any activity that obstructs or alters navigable waters of the U.S., or the course, location, condition, or capacity of any port, harbor, refuge, or enclosure within the limits of any breakwater, or of the channel of any navigable water.

Both the Proposed Action and Pearl Harbor site would require a DA permit.

1.6.1.4 Coastal Zone Management Act (CZMA) of 1972 (16 USC §§1451–1465 *et seq.*)

To the maximum extent practicable, Federal actions affecting any land/water use or coastal zone natural resources, must be consistent with the enforceable policies of an approved state coastal zone management program. The CZMA requires a consistency determination from DBEDT for actions within the coastal zone, as defined by Hawai‘i Revised Statutes (HRS) §205A-1. Coastal Zone Management (CZM) consistency determinations are not required for actions on Federal property that would not have reasonably foreseeable direct and indirect effects on any use or resource in the coastal zone.

The DBEDT, State Office of Planning, CZMP has accepted the Navy’s Negative Determination Notices that consistency determinations are not required under the CZMA for the Proposed Action (Appendix A-3), and Pearl Harbor alternative (Appendix B-3).

1.6.1.5 Endangered Species Act (ESA) of 1973 (16 USC §§1531–1544 *et seq.*)

The ESA requires Federal agencies to assure that their actions are not likely to jeopardize the continued existence of any threatened or endangered species, or result in destruction or adverse modifications of habitat critical to those species. Federal agencies are required to consult with the USFWS and NMFS wherever they propose actions that may affect listed species or their habitat.

The Navy and MCBH Kaneohe Bay have completed an informal consultation under Section 7 of the ESA. The USFWS and NMFS concur with the Navy that the Proposed Action is not likely to adversely affect threatened and endangered species under their jurisdictions (Appendix A-4). Should the Pearl Harbor alternative be selected, the Navy would initiate an informal Section 7 consultation for that site.

1.6.1.6 Fish and Wildlife Coordination Act (FWCA) of 1934, as amended (16 USC §§661–666[c] *et seq.*)

The FWCA provides for consultation with the USFWS and other relevant agencies when a Federal action proposes to modify or control U.S. waters for any purpose. The reports and recommendations of the head of the state agency exercising administration over the wildlife resources of the state are to be made an integral part of any report prepared or submitted by a Federal agency.

The Proposed Action at MCBH Kaneohe Bay and Pearl Harbor alternative, if selected, would consider recommendations made by appropriate agencies.

1.6.1.7 Magnuson-Stevens Fishery Conservation and Management Act (16 USC §1801 *et seq.*)

The Magnuson-Stevens Act (16 USC §1801 *et seq.*), as amended by the Sustainable Fisheries Act, PL 104-297, calls for action to stop or reverse the loss of marine fish habitat. The waters out to 200 miles (mi) (321.80 kilometers [km]) around the Hawaiian Islands are under the jurisdiction of the Western Pacific Regional Fishery Management Council (WPRFMC). The WPRFMC has approved Fisheries Management Plans (FMPs) designating EFHs and HAPC. WPRFMC has designated all the ocean waters surrounding O‘ahu, from the shore to depths of over 100 ft (30.5 m) as EFH. As defined in the 1996 amendments to the Act, HAPC are a subset of EFH which are habitat areas that are "rare, particularly susceptible to human-induced degradation, especially ecologically important, or located in an environmentally stressed area."

No HAPC are designated at either MCBH Kaneohe Bay or the Pearl Harbor sites.

1.6.1.8 Marine Mammal Protection Act (MMPA) of 1972, as amended (16 USC §§1361–1421(h) *et seq.*)

Reauthorized in 1994, the MMPA establishes a moratorium, with certain exceptions, on the taking of marine mammals in U.S. waters and by U.S. citizens on the high seas, and on importing of marine mammals and marine mammal products into the U.S.

The project has been designed in a manner that complies with the MMPA. Design of the WEC buoys and associated equipment incorporated input from marine scientists to minimize risks to marine mammals.

1.6.1.9 Migratory Bird Treaty Act (MBTA) of 1918, as amended (16 USC §§703–712 *et seq.*)

The MBTA is a bilateral migratory bird treaty with Canada, Mexico, Japan, and Russia. Sections 703 to 712 of the Act prohibit the taking of migratory birds in the absence of a permit.

No bird takes are anticipated due to the proposed WET test; therefore, a permit under the MBTA is not required.

1.6.1.10 National Historic Preservation Act (NHPA) of 1966 (16 USC §470 *et seq.*)

The Proposed Action has been evaluated for potential effects on historic properties. Section 106 of the NHPA of 1966, 16 USC §470(f), as amended, requires Federal agencies having direct or indirect jurisdiction over a Federal undertaking to take into account effects on any district, site, building, structure, or object that is included or is eligible for inclusion in the National Register of Historic Places (NRHP), prior to the approval of expenditure of any funds or issuance of any license or permit.

In accordance with the regulations implementing Section 106 of the NHPA, 36 CFR Part 800, the Hawaii State Historic Preservation Officer (SHPO) was consulted on the Proposed Action and concurred with the Navy's finding of "no historic properties affected." Notification of this finding was also provided to Native Hawaiian organizations and individuals that have previously expressed an interest in actions involving the Mokapu Burial Area. Section 106 correspondence are provided in Appendix A-5.

1.6.1.11 Native American Graves Protection and Repatriation Act (NAGPRA) of 1990 (25 USC §3001)

NAGPRA provides for the protection and repatriation of Native American and Native Hawaiian human remains and cultural items discovered on Federal lands. The Proposed Action was reviewed and determined unlikely to result in the discovery of Native Hawaiian human remains or cultural items. Should such items be discovered during project implementation, NAGPRA regulations pertaining to inadvertent discoveries (43 CFR 10.4) will be followed.

1.6.1.12 EO 13089, Coral Reef Protection (63 FR 32701)

EO 13089, dated June 11, 1998, directs all Federal agencies whose actions may affect U.S. coral reef ecosystems to:

- identify their actions that may affect U.S. coral reef ecosystems;
- utilize programs and authorities to protect and enhance the condition of such ecosystems; and
- to the extent permitted by law, ensure that any actions they authorize, fund, or carry out will not degrade the conditions of such ecosystems.

Marine biological consultants and agency personnel conducted underwater site assessments for the Proposed Action to identify suitable cable routes and locations for the buoy array to minimize impacts to coral reefs. This document discloses the finding from these site assessments.

1.6.1.13 EO 13186, Responsibilities of Federal Agencies to Protect Migratory Birds (16 USC §§ 703–711) (66 FR 3853)

Under EO 13186, dated January 10, 2001, all Federal agencies taking actions that have, or are likely to have, a measurable negative impact on migratory bird populations are directed to develop and implement a Memorandum of Understanding (MOU) with USFWS that promotes the conservation of migratory bird populations.

The Proposed Action would avoid interaction with habitat used by migratory bird populations; hence, testing of the WEC system is not anticipated to have a measurable negative impact on those populations.

1.6.1.14 EO 12898, Environmental Justice

Under EO 12898, dated February 11, 1994, Federal agencies are required to address the potential for disproportionately high and adverse environmental effects of their actions on minority and low-income populations. Agencies are required to ensure that their programs and activities that affect human health or the environment do not directly or indirectly use criteria, methods, or practices that discriminate on the basis of race, color, or national origin. NEPA documents are specifically required to analyze effects of Federal actions on minority and low-income populations and, whenever feasible, to develop mitigation measures to address significant and adverse effects on such communities. The EO states that the public, including minority and low-income communities, should have adequate access to public information relating to human health or environmental planning, regulation, and enforcement.

With both sites, the land component of the proposed WET test would be located on military property where access and use of resources are restricted. At Pearl Harbor, the offshore component of the project is located within restricted waters. At MCBH Kaneohe Bay, the WEC buoy array would be located outside the 500-yard (yd) (457-m) buffer zone within the Naval Defensive Sea Area (NDSA) established by EO 8681. Although the area outside the buffer zone

is subject to access limitation, there are no plans to restrict public access into the area, which includes the proposed buoy area.

If the restricted area off MCBH Kaneohe Bay were to be extended to provide security for the WEC buoy array, there would be loss of access to the area and use of the resources for the two- to five-year duration of the project. The impacts of the temporary closure of a relatively small area are not anticipated to be significant. Therefore, the project would not impose disproportionately high, adverse effects on minority or low-income populations that may use the area.

1.6.1.15 EO 13045, Protection of Children from Environmental Health Risks and Safety Risks

Under EO 13045, dated April 21, 1997, Federal agencies are required to address the potential for disproportionately high and adverse environmental effects of their actions on children. Agencies are required to identify and, if necessary, mitigate health and safety risks with the potential to disproportionately affect children. The EO requires that agencies ensure that their policies, programs, activities, and standards address such risks.

Testing of the WEC system would not disproportionately affect children. The sites being considered do not contain schools, playgrounds, or similar areas where children are frequently present. Recreational areas where children may be present are at MCBH Kaneohe Bay. Because no significant health and safety risks are anticipated from the proposed WET test, and the affected areas are not frequented by children, no mitigation is needed.

1.6.1.16 EO 13123, Greening the Government Through Efficient Energy Management (65 FR 24595)

EO 13123, Part 2, Section 204, dated April 21, 2000, states “each agency shall strive to expand the use of renewable energy within its facilities and in its activities by implementing renewable energy projects and by purchasing electricity from renewable energy sources.” The WET test would be consistent with this goal and with the policy mandated by the Energy Policy Act of 1992, which states that “it is the goal of the U.S. to carry out energy supply and energy conservation research and development to meet a number of goals, including the strengthening of national energy security by reducing the dependence on imported oil.”

1.6.2 Regulatory Requirements

Government permits and consultations identified during the scoping process and development of this document are identified in Table 1-1. This table provides a quick reference but is not meant to be a comprehensive listing of all approvals that may be eventually required.

The Navy will be responsible for obtaining permits and completing consultations for work at MCBH Kaneohe Bay or Pearl Harbor. Any necessary consultations associated with the MCBH

Kaneohe Bay site will be conducted in conjunction with the MCBH Kaneohe Bay. The project is being proposed within Federally owned submerged property; therefore, State permits are not applicable.

Table 1-1. Summary of Possible Government Permits and Consultations

Permit, Consultation, or Concurrence	Regulatory Agency
DA Permit as required by Section 10 of the Rivers and Harbors Act	USACE
Negative Determination under the CZMP	DBEDT, State Office of Planning, CZMP
Informal consultation in accordance with Section 7 ESA	U.S. Department of Commerce, NMFS U.S. Department of the Interior, USFWS
Consultation in accordance with Section 106 of the NHPA	State DLNR, SHPO
Local Notice to Mariners	USCG
Navigational aids on buoys	USCG
Site approvals from MCBH Kaneohe Bay	U.S. Marine Corps

1.6.3 Coordination Requirements

Applicable requirements for this project include coordination with NMFS, USFWS, and State DLNR regarding protection and conservation of fish and wildlife resources.

1.7 CONSISTENCY WITH LAND USE PLANS, POLICIES, AND CONTROLS

Planning documents that were used as reference material in this EA for the Proposed Action include the following: *Marine Corps Base Hawaii Integrated Natural Resources Management Plan and Environmental Assessment* (Marine Corps November 2001); *Marine Corps Base Hawaii Master Plan, Volume I* (Marine Corps June 1999); and *A Natural Resources Survey of the Nearshore Waters of Mokapu Peninsula, Kaneohe Marine Corps Air Station* (Marine Corps Air Station 1992). Documents used as reference material for the Pearl Harbor alternative include the *Final Environmental Impact Statement, Outfall Replacement for Wastewater Treatment Plant at Fort Kamehameha, Navy Public Works Center, Pearl Harbor, Hawaii* (Navy March 2001); *Pearl Harbor Naval Complex Integrated Natural Resource Management Plan* (Navy October 2001); and “Marine Natural Resources Insert for the WET EA” (Navy July 2002a) (Appendix D). Full citations for these documents can be found in Chapter 6, References.

Applicable land use plans, policies, and controls are those required for Federal lands, specifically MCBH Kaneohe Bay, and Naval Magazine (NAVMAG) Pearl Harbor, West Loch Branch. Each alternative will comply with base specific land use plans, policies, and controls. State and City and County of Honolulu land use plans, policies, and controls are not applicable because all project alternatives are on Federal property.

Land use documents consulted for preparation of this EA include the MCBH and Pearl Harbor Integrated Natural Resource Management Plans (INRMPs). These were prepared in cooperation with USFWS, NMFS, and State DLNR as required by the Sikes Act Improvement Act of 1997.

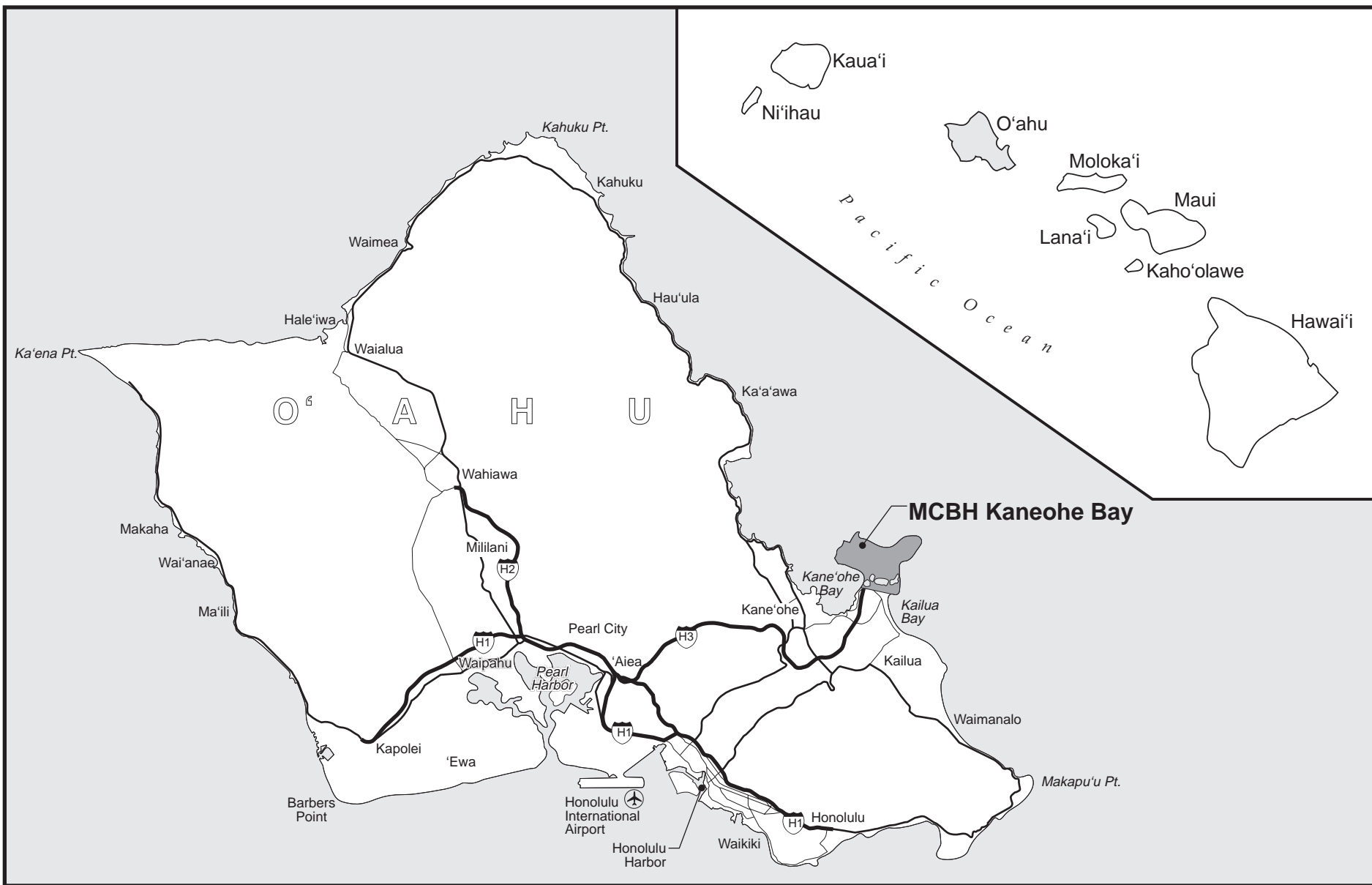

NORTH

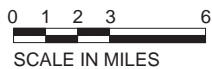
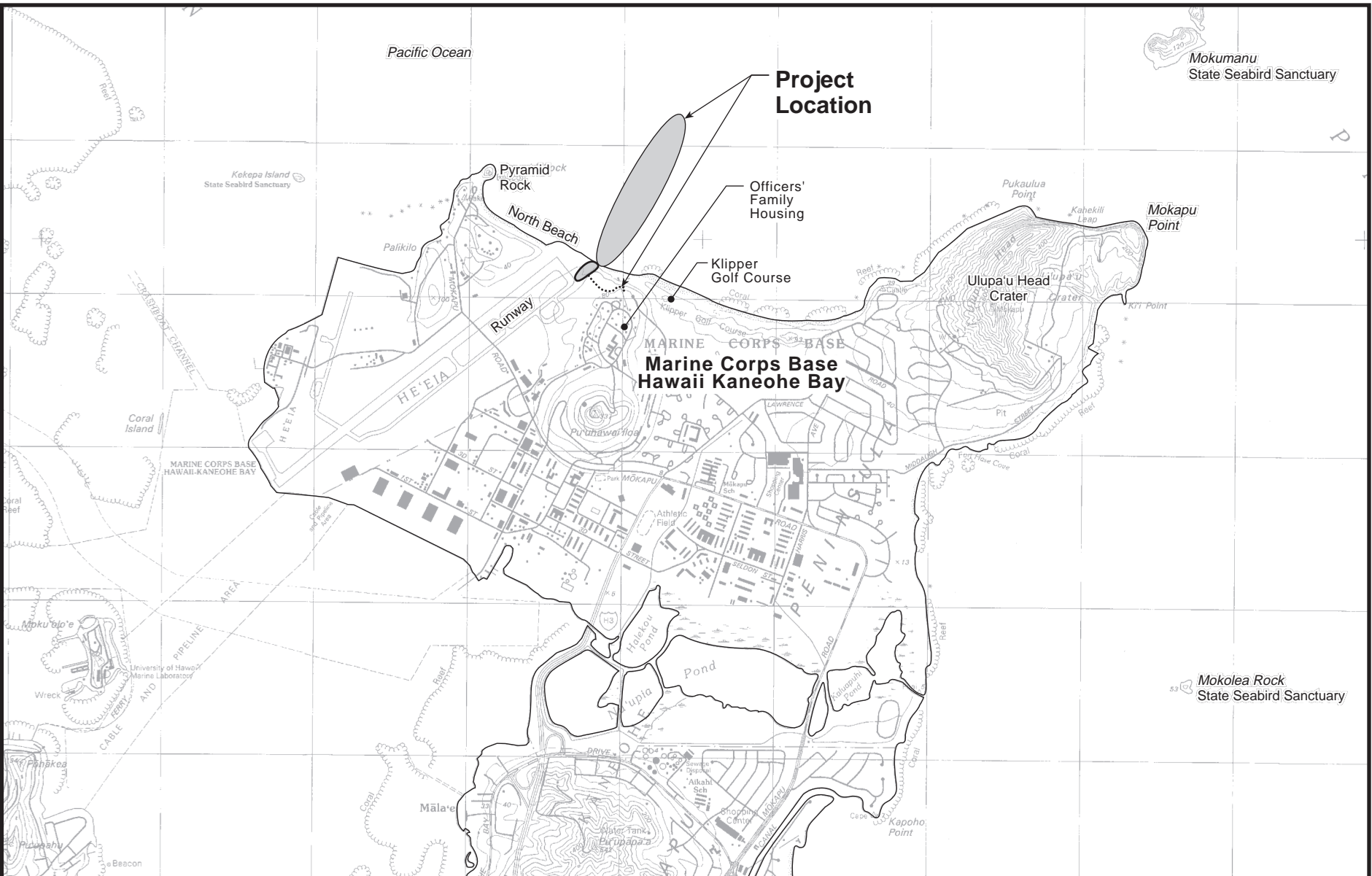

Figure 1-1
REGIONAL LOCATION

Environmental Assessment
Wave Energy Technology Project



0 500 1000
SCALE IN METERS

0 1000 2000 3000
SCALE IN FEET

Source: NAVFAC Dwg.No. 7,011,984

Legend

--- Proposed Land Cable Route

Figure 1-2
PROJECT VICINITY
North Beach, MCBH Kaneohe Bay

Environmental Assessment
Wave Energy Technology Project

Chapter 2

Alternatives Including the Proposed Action

CHAPTER 2

ALTERNATIVES INCLUDING THE PROPOSED ACTION

2.1 INTRODUCTION

This chapter describes the Proposed Action (the preferred alternative) and alternatives, including the screening process used to determine which alternative sites would be evaluated in detail. The Congressional appropriation to conduct the WET test stipulates that testing is to occur in Hawai‘i, which has coastal locations with high wave energy potential. To minimize security risks to the WEC system and maximize system survivability, only coastal DoD sites were considered. The screening process focused on comparing the objectives of the Proposed Action with alternative site locations in the state. Information on these alternative sites is summarized from the report, *A Preliminary Site Assessment of Wave Power Buoy Locations* (Sea Engineering, Inc. and Makai Ocean Engineering 2000). This report reviewed wave climate, suitability of the sites relative to the cost of installation, operations and maintenance, and potential conflicts.

2.2 PROCESS USED TO FORMULATE THE ALTERNATIVES

Various locations at coastal DoD installations within the state of Hawai‘i were identified during the planning phase of the project. Sites selected for preliminary screening included the Pacific Missile Range Facility (PMRF) at Nohili Point and Makaha Point, Kaua‘i; Bellows Air Force Station (AFS), Waimanalo, O‘ahu; and NAVMAG Pearl Harbor, West Loch Branch, O‘ahu (Figure 2-1). A preliminary screening of the physical characteristics of these locations was completed relative to their ability to fulfill the objectives outlined in Section 1.3 (Sea Engineering and Makai Ocean Engineering 2000).

Sites were reviewed for their wave energy characteristics, costs associated with installation considerations (such as cable length, shore side grid connection, and proximity to initial staging area), and land use compatibility to optimize data collection and minimize the risk of system failure. An additional objective of site selection was the need to challenge the WEC system under winter storm conditions while providing some shelter or reduced exposure to Kona storm³ or hurricane waves to avoid excessive maintenance. Although the system was designed to a 500-year storm, extreme Kona storm and hurricane waves could exceed the design capability of the system, increasing concerns about public safety and system survivability. Kona storm waves can

³ Kona storms are low pressure areas (cyclones) of subtropical origin which usually develop northwest of Hawai‘i in winter and move slowly eastward, accompanied by southerly winds, from whose direction the storm derives its name (Kona means “leeward” in Hawaiian) and by the clouds and rain that have made Kona storms synonymous with bad weather in Hawai‘i (Atlas of Hawaii 1983).

occur throughout the year but are most common from October through April. Typical wave heights are from 10 to 15 ft (3 to 4.5 m) with periods from 8 to 10 seconds.⁴

Hurricanes, while infrequent in Hawai‘i, can produce extremely high winds and wave conditions. Hurricane Nina brought surf conditions of 35 ft (10.7 m) to Kaua‘i’s southern coast in late November 1957.⁵ An analysis of waves generated by two recent hurricanes that impacted O‘ahu (Hurricane ‘Iniki in 1992 and Hurricane ‘Iwa in 1982) indicates that the waves approached from the southeast through west directions. While the WEC system has been designed to withstand the maximum conditions of a design scenario hurricane, exposure to Kona storm and hurricane waves is not a desired objective of the proposed test. The model hurricane developed for the WET test is defined as the probable hurricane that will strike the Hawaiian Islands and is based on the characteristics of hurricanes Dot (1959) and ‘Iwa, both of which impacted the islands. For this project, the hurricane’s approach is assumed to be from the east through southeast direction. The calculated maximum deepwater wave height is 48.9 ft (14.9 m), and the associated maximum height in 98.4 ft (30 m) of water is 44.6 ft (13.6 m) (Appendix E).

Results of the initial screening of coastal DoD installations with the project’s objectives (Section 1.3) are summarized in Table 2-1. Based on the results of Table 2-1, three sites were eliminated from further detailed study. These sites are discussed in the following section.

2.3 ALTERNATIVES CONSIDERED BUT ELIMINATED FROM DETAILED STUDY

The following alternative site locations were eliminated from further detailed study:

- PMRF (Makaha Point, Kaua‘i),
- PMRF (Nohili Point, Kaua‘i), and
- Bellows AFS (Waimanalo, O‘ahu).

The advantages and disadvantages of each of these sites are discussed below, relative to their ability to fulfill the objectives of the Proposed Action identified in Section 1.3. Because the wave energy density objective is fulfilled at all alternative site locations, it is not discussed.

⁴ Hawaii Coral Reef Assessment and Monitoring Program (CRAMP) Web site. <http://cramp.wcc.hawaii.edu/Results/Forcing_Functions/Wave_Energy/Kona_Storm_Waves>; accessed August 23, 2002.

⁵ Hawaii Coral Reef Assessment and Monitoring Program (CRAMP) Web site. <http://cramp.wcc.hawaii.edu/Results/Forcing_Functions/Wave_Energy/Hurricane_Waves>; accessed August 23, 2002.

Table 2-1. Site Evaluation Matrix

Factor	Threshold (minimum requirement)	Objective (optimal requirement)	PMRF Nohili Point, Kaua'i	PMRF Makaha Point, Kaua'i	Bellows AFS, Oah'u	NAVMAG Pearl Harbor, West Loch Branch	MCBH Kaneohe Bay
Wave Climate Conditions							
Nominal operating wave climate (frequency/ amplitude)	6- to 12-s period 3.3-ft (1.0-m) wave height or greater all year	5- to 10-s period 4.9-ft (1.5-m) wave height or greater all year	Poor	Reasonable waves in late fall, winter	Excellent	Partially sheltered from prevailing trade wind waves. Marginal wave conditions.	Excellent
Hurricane/ Kona exposure	Limited exposure	Sheltered from hurricane swells	Direct exposure	Partial exposure/ Direct exposure	Sheltered	Full exposure	Direct approach of hurricane waves unlikely/ Sheltered
Cost Considerations—Installation, Operations, and Maintenance							
Bottom conditions	Minor relief or irregularities, minimum coral that can be avoided	Relatively flat sandy bottom with little to no relief or irregularities	Flat bottom with some vertical relief up to 3 to 5 ft (0.9 to 1.5 m)	Unknown	Mix of sand and hard limestone bottom with some coral. Need to find suitable passage through the fringing reef 1.23 mi (1.1 NM) offshore.	Central portions of the entrance channel are flat and composed primarily of sand and rubble. Channel edges include areas with high relief and coral.	Relatively flat bottom, 3 to 4 ft (0.9 to 1.2 m) irregularities between approximately 15 to 35 ft (4.6 to 10.7 m) depths
Length to run cable	3.79 mi (6.1 km)	Max 0.95 mi (1.5 km)	1.4 mi (2.2 km)	4.03 mi (6.5 km)	3.03 mi (4.9 km)	2.41 mi (3.9 km)	0.74 mi (1.2 km)
Proximity to initial staging area (Honolulu Harbor)	Less than 1-day transit time	Less than 1-hr transit time	138.1 mi (222 km) 24 hrs for barge; 17 hrs for workboat	143.8 mi (231 km) 25 hrs for barge; 18 hrs for workboat	21.9 mi (35.2 km) 5 hrs for barge; 3 hrs for workboat	1.2 mi (1.9 km) 1 hr each for barge or workboat	28.8 mi (46.3 km) 7 hrs for barge, 5 hrs for workboat

Table 2-1. Site Evaluation Matrix *(continued)*

Factor	Threshold (minimum requirement)	Objective (optimal requirement)	PMRF Nohili Point, Kaua'i	PMRF Makaha Point, Kaua'i	Bellows AFS, Oah'u	Pearl Harbor (NAVMAG West Loch), Oah'u	MCBH Kaneohe Bay
Cost Considerations—Installation, Operations, and Maintenance <i>(continued)</i>							
Shoreside grid connection	Must be easily accessible by vehicle without damage to environment	Must be accessible by vehicle without damage to environment and in close proximity to facilities	Acceptable	Unknown, probably difficult	Acceptable	Excellent	Excellent
Accessibility to ocean site for visual inspection and maintenance	Accessible for visual inspection and less than 1-day transit time	Personnel available for visual inspection and less than 1-hr transit time	Moderately difficult for inspection, very difficult for maintenance	Moderately difficult for inspection, very difficult for maintenance	Acceptable	Acceptable	Acceptable
System Survivability							
Compatibility with current operations and activities	Such that other activities will not impact schedule or equipment	No other activities in immediate area	High risk for schedule delays	High risk for schedule delays	Amphibious landing exercises, high risk for schedule delays	Acceptable	Acceptable

ft = feet
 hr(s) = hour(s)
 km = kilometer
 mi = mile(s)
 s = second(s)

2.3.1 PMRF (Makaha Point, Kaua‘i)

An approximate 2-mi (3.2-km) long sector off the west coast of Kaua‘i, about 4 to 5 mi (6.4 to 8.0 km) north of the PMRF, was considered in the preliminary screening process (Figure 2-1). PMRF is the world’s largest instrumented, multi-environment, military test range capable of collecting data on the performance of a variety of weapons systems that operate underwater, on the surface, in the atmosphere, and in space. The shoreline and offshore areas at PMRF contain an extensive offshore test range and hydrophone array. This military testing environment is not duplicated anywhere in the world. The location would allow favorable exposure to waves during the late fall and winter, increasing the potential for testing the system’s operation under variable conditions. Despite this favorable condition, the PMRF Makaha Point alternative was eliminated for reasons summarized in the following paragraphs.

- The site provides partial exposure to trade wind generated waves and full exposure to the winter season north Pacific swells that create very rough coastline conditions in the winter. It has a high probability of being directly exposed to Kona storm waves and has been at least partially exposed to hurricane waves during the last two major hurricanes to hit Hawai‘i. While the site would challenge the system under winter storm conditions, the exposure to both Kona storm waves and hurricane waves could exceed the design capability of the system and hence, reduce the suitability of the site for operational use of the WEC technology.
- Due to the military testing environment of PMRF, there is very little certainty that WEC system testing could occur for up to a five-year period. Similarly, there is little certainty that there would be an opportunity to deploy more than one buoy.
- The required length of undersea cable, 4.03 mi (6.5 km), and the distance from the initial staging area at Honolulu Harbor or Barbers Point would raise the costs of installation to prohibitive levels. In addition, access to the site for maintenance would be very difficult.
- Incompatible land uses in the project area, such as recreation, would jeopardize the security of the system and threaten system survivability. Offshore, tour boats of up to 50 ft (15 m) in length, pass during the summer months on sightseeing tours of the Na Pali coastline. Near shore and onshore activities include swimming, surfing, and camping.

2.3.2 PMRF (Nohili Point, Kaua‘i)

Nohili Point is located on the west coast of Kaua‘i, directly off PMRF (Figure 2-1). While this location is sheltered from much of the trade wind energy, it would allow favorable exposure to waves during the late fall and winter, increasing the potential for testing the system’s operation under variable conditions. Installation considerations are acceptable relative to seafloor conditions and an undersea cable length of approximately 1.4 mi (2.2 km). Accessibility to a shoreside grid connection is unknown, but power poles should be accessible in the immediate area of Nohili Point. Despite these favorable conditions, the PMRF Nohili Point alternative was eliminated from further study for the following reasons.

- As with PMRF Makaha Point, a high probability of having direct exposure to both Kona storm and hurricane wave conditions reduces the suitability of the area.
- Due to the sensitivity of the existing cables at PMRF, installation of the WEC cable could create the potential for cross-talk that could impact range activities. Such impacts would not be tolerated by the range and could result in schedule delays or project cancellation. Delays or cancellations would reduce the potential for consistent data collection and could preclude installation of more than one buoy during the five-year testing period.
- The distance from the initial staging area at Honolulu Harbor or Barbers Point would raise the costs of installation to prohibitive levels. Access to the site for inspection and maintenance is considered difficult.
- Incompatible land uses in the project area, such as recreation, would jeopardize the security of the system and threaten system survivability. Offshore, tour boats of up to 50 ft (15 m) in length pass during the summer months on sightseeing tours of the Na Pali coastline. Nearshore and onshore activities include swimming, surfing, and camping.

2.3.3 Bellows AFS (Waimanalo, O‘ahu)

On the windward coast of O‘ahu, Bellows AFS (Figure 2-1) provides excellent wave climate conditions, especially during the winter months, thus enabling the WEC system to be challenged under variable conditions. The site is sheltered from both Kona storm and hurricane waves, promoting survivability of the system. It has good access for installation, operations, and maintenance activities, as well as power grid connections, and is located within one day of travel time from the initial staging area of Honolulu Harbor or Barbers Point. Despite these favorable conditions, Bellows AFS was eliminated from further study for the following reasons.

- Marine Corps training could interfere with data collection over a two- to five-year period and the installation of more than one buoy. Marine Corps units use some of the joint-use public beach for amphibious training on weekdays. Assault on the beachhead exercises are conducted on the more southern part of the beach. Water parachute drops and helicast (the use of helicopters to drop swimmers and equipment into the water for clandestine beach entry) by reconnaissance swimmers are additional means of assault beach entry. These activities would threaten WEC system survivability, especially in the area of the buoy array.
- The required length of undersea cable, 3.03 mi (4.9 km), would raise the costs of installation to prohibitive levels.
- Incompatible land use in the project area, such as Marine Corps amphibious landing exercises, could be hampered by the presence of the WEC buoy array.

2.4 DESCRIPTION OF PROPOSED ALTERNATIVES

2.4.1 Alternative A: Proposed Action

2.4.1.1 General Description and Site Selection Factors

The Proposed Action is the phased installation and operational testing of up to six WEC buoys off of North Beach, MCBH Kaneohe Bay, over an approximate time frame of two to five years. Figure 2-2 depicts the proposed undersea cable route and buoy array. The buoys would be anchored in approximately 100 ft (30.5 m) of water using a heavily ballasted anchor base, rock-bolted to the seafloor. A nearby equipment canister, fixed to the seafloor, would convert the mechanical energy into electrical energy for the first two buoys. It is anticipated that the last four buoys would be connected to a second canister. If design improvements do not provide this efficiency, a maximum of three canisters would be required, each serving two buoys. Hydraulic lines would run from each buoy and have separate designated attachment points to the equipment canister. An armored and shielded undersea power cable, connected to the canister(s), would transmit electrical power to land. The cable would be stabilized on the seafloor using grouted rock bolts and protective split pipe (Figure 2-2).

On shore, the undersea cable would be spliced to a land transmission cable inside a concrete utility vault, located above the high water mark. From the utility vault, the land cable contained in a conduit would be elevated off the ground using pedestals placed at intervals. The cable would be routed to Battery French, located on the side of the hill behind the Officers' Family Housing area. Figure 2-3 shows the proposed land cable route. From Battery French, used to house the onshore electrical power and control equipment, the power cable would be routed to the base electrical grid system using an existing underground duct system. Each WEC buoy is expected to produce an average of 20 kW of power (sufficient to power approximately four to six single-family residences). The peak output for each buoy is 40 kW.

Installation of the first two buoys, scheduled for no earlier than the beginning of calendar year 2003, is intended to verify the installation procedures and operational performance characteristics of the WEC system. If funding availability allows, additional buoy installation would focus on ongoing design upgrades and on performance and reliability testing. A potentially beneficial impact would result from the growth of benthic organisms such as corals on the WEC cable and anchor during the test period. In consultation with NMFS and DLNR, the Navy will determine at the end of the test period whether the material installed on the seafloor should be removed or left in place. Land equipment would be removed.

The MCBH Kaneohe Bay site is best suited to accomplish the project objectives. The site provides a high wave energy density environment to test the WEC technology (the site is exposed to waves with average heights greater than the minimum 3 ft [1 m], and optimum 5 ft [1.5 m], required for testing); is periodically exposed to winter storms but completely sheltered from Kona storms; and the direct approach of hurricane waves is unlikely. The site is conducive to installation of multiple buoys, presenting the opportunity to observe the effects of more than

one buoy on system performance. It also provides good access for installation, operations and maintenance activities, and power grid connections. Part of the undersea cable route and the land based components would be within a restricted area minimizing risks to WEC system security and optimizing data collection. Onshore and nearshore recreational activities within the restricted area include beachcombing, surfing, swimming, fishing, and SCUBA diving. The proposed buoy array site is currently open to public access, and incompatible activities include fishing, boating, and diving.

2.4.1.2 WEC System Components

WEC Buoy

The WEC buoy is comprised of a cylinder, buoyancy tank, and central rigid spar buoy (Figures 2-4 and 2-5), which are described below. The buoyancy tank and its attached cylinder are designed to float 3 to 13 ft (1 to 3.9 m) below the surface.

Buoyancy Tank. The buoyancy tank, attached to the top of the buoy cylinder, is the same diameter as the cylinder and approximately 11 ft (3.4 m) in length. It is designed to provide enough buoyancy to float itself and the attached cylinder.

Buoy Cylinder. The buoy cylinder is a hollow steel unit approximately 15 ft (4.6 m) in diameter and 39 ft (11.9 m) long. It moves up and down the spar buoy, creating motion that is converted to useable energy. The buoy cylinder is connected to a hydraulic cylinder. As the buoy cylinder oscillates on the spar buoy, the hydraulic cylinder acts as a hydraulic pump. Pressurized fluid is passed from the cylinder to a power conversion module located in the equipment canister. The hydraulic system converts the linear motion of the buoy to rotary motion to spin the generator, housed in the equipment canister.

The interior structure of the buoy is comprised of conventional round, cross-section circumferential rib stiffeners that are approximately 4 inches (in) (100 millimeters [mm]) in diameter, and round, cross-section vertical stringer assemblies approximately 3 in (75 mm) in diameter (Figure 2-5 and Appendix F). Three-arm spider assemblies with arms approximately 6 in (150 mm) in diameter support the skin of the buoy at three locations, and the buoy head assembly at the top of the buoy. The interior of the buoy is free of obstructions, sharp edges, or corners. A minimum water depth of 90 ft (28 m) would be required to accommodate the required length and stroke of the oscillation section of the buoy.

Spar Buoy. The spar buoy, constructed of steel, is positively buoyant. Fixed to a ballasted anchor, it keeps the system upright while swaying back and forth with the motion of the waves. A universal joint located at the bottom of the spar buoy allows motion of the buoy on two axes.

An antifouling finish would be used on the exterior of the buoys, applied from the universal joint to the top of the system, to prevent accumulation of marine organism deposits. No ecological hazards are indicated post-application. The Material Safety Data Sheet (MSDS) provided in Appendix G, states that there is no marine pollution hazard from the applied product. The antifouling finish would not be applied to the anchor base.

Wave Buoy Array

The configuration and proposed location of the wave buoy array would be chosen such that the effect of energy extraction from the waves by the seaward buoys on the shoreward buoys could be investigated (Figure 2-2). This would demonstrate the effect of buoy placement on WEC power generation.

Buoy Anchor

Each WEC buoy would be anchored using a heavily ballasted anchor assembly consisting of two components: an anchor base plate and anchor weights (Figure 2-4). The anchor base plate would be ringed by a flange frame that would be rock-bolted to the sea floor (Figure 2-6a). The anchor base plate would be loaded with 35 to 75 tons (32 to 68 metric tons) of anchor weights. The anchor weights would prevent vertical movement of the base, and the rock bolts on the anchor base plate would prevent horizontal movement under design wave conditions with a holding force up to 100 tons (91 metric tons). The anchor assembly would be designed to resist the hurricane scenario described in Section 2.2 in order to prevent the buoy from detaching from the moorings and creating a public safety hazard.

Mooring Clumps

In addition to the buoy anchors, four “mooring clumps” would be placed on the sea floor to allow stable mooring of the workboats required for installation and periodic inspection of the WEC system (Figure 2-7). Each mooring would consist of a 7,000-pound (lb) (3,175.1-kilogram [kg]) maximum concrete block, attached to a 100-ft (30.5-m) maximum length of anchor chain secured taut to a grouted rock bolt sunk into the substratum (Figure 2-8). The chain and rock bolts are safety measures to prevent the mooring from being dragged long distances across the bottom if extreme loads are applied to the mooring lines. Calculated maximum area of movement of the anchor chain is about 1 ft (0.3 m) in the unlikely event that the concrete block is moved.

During installation, and every other month after installation for the duration of the test period, an 80-ft (24.4-m) boat would transit to the site and attach mooring lines to each of the four floats. This configuration would provide stability for use of the vessel as a dive platform. The mooring would ensure that there is no contact with the WEC boys during installation and maintenance.

Equipment Canister

The equipment canister (Figure 2-4) is a conventional underwater pressure vessel that contains components to produce and control power, including hydraulics, generator, resistors, transformers, circuit breaker, and computer and data acquisition equipment. Its dimensions are 9 by 7 by 7 ft (2.7 by 2.1 by 2.1 m). The equipment canister would be attached to a base that would be rock-bolted to the seafloor in a central location between buoys number 1 and 2 (Figure 2-2), and would have attachment points for the first and second buoys. If required, up to three canisters would be installed for service to all six buoys, with two buoys attached to each canister.

Power generated by the components of the equipment canister would be transmitted to shore via the undersea transmission cable.

The working fluid for the buoy's power generating system would be a biodegradable hydraulic fluid consisting of a chemically stable, vegetable oil based liquid. There would be approximately 13.2 to 26.4 gallons (50 to 100 liters) of hydraulic fluid per buoy. The MSDS for the hydraulic fluid is provided as Appendix G. Antifouling finish would be applied to portions of the equipment canister including its base.

Undersea Transmission Cable

The generator and high-voltage transformer would be connected to a waterproof and electrically insulated undersea power transmission cable with an outside diameter of approximately 2.6 in (66.4 mm). The cable would be enclosed in armoring and covered with an outer sheathing made of synthetic materials. The cable materials are inert or non-toxic.

In addition to transmitting power to the utility vault, the cable would contain fiber optic or twisted pair communication lines to transfer data to and from shore equipment. The undersea cable would be designed to carry 250 kW and transmit power for up to six buoys, as well as resist the design scenario hurricane described in Section 2.2.

Utility Vault

An onshore concrete utility vault would serve as a junction box between the undersea transmission cable and the land transmission cable. The vault would be approximately 4 ft wide by 2 ft long by 3 ft high (1.2 m wide by 0.6 m long by 0.9 m high), maximum size, and weigh 450 lb (204 kg). The cables would be bolted to the utility vault at the entrance and exit points to prevent movement or tampering. The vault would be placed on a bed of gravel or other porous material to provide a level surface and adequate drainage.

Land Transmission Cable

The land transmission cable would be encased in a polyvinyl chloride (PVC) conduit and elevated off the ground using pedestals placed at intervals along the cable route. The conduit would run from the utility vault to the equipment shelter at Battery French, following the route shown in Figure 2-3. The route proceeds east over the slope of the hill behind the Officers Family Housing area. Where it crosses the dirt path, the conduit would be protected by either gravel or concrete.

Equipment Shelter

The cable would enter Battery French through a hole cut into an existing wire mesh screen and doorway. It would be mounted along the length of the main interior corridor wall and exit through an existing doorway. Battery French would serve as the land based equipment shelter containing onshore electrical power and control equipment comprised of a computer, transformer, alternate current/direct current (AC/DC) and DC/DC converters, capacitor bank,

battery bank and an inverter. Power would be transmitted to the existing electrical grid system via a cable, which could be installed in existing underground duct banks. Modifications to Battery French, expected to be minimal, would consist of installing air conditioning, replacing existing air ducts and improving ventilation, providing access to the shore-based transmission cable, providing EXIT signs, and reinstalling 115-volt (v) power outlets and lighting. General cleaning of floors and walls, and the removal of abandoned furnishings, equipment, and fixtures will occur in the rooms to be used. Interior doors and associated hardware may be replaced to ensure security.

2.4.1.3 Installation Procedures

Undersea Transmission Cable

Cable installation procedures are described for the entire cable route with detailed description provided for the shore-based activities and the first 700 feet. The day before laying the undersea cable, divers will lay a wire rope along the proposed cable route, determined by previous surveys, from about the 18- to the 30-ft (5.5- to 9.1-m) water depth, a distance of 700 ft (213.4 m). Using a Differential Global Positioning System (DGPS), the rope will be placed along the pre-surveyed cable route. Divers will reposition the wire rope, as needed, to avoid as much vertical relief and live coral as possible. The wire rope will serve to guide the divers in positioning the main cable during installation.

The proposed landing point for the cable is adjacent to the northeast corner of the shoreline revetment at North Beach (Figure 2-9). On the day of installation, a vessel would be anchored with a four-point mooring directly off the landing site as close as the surf permits (10- to 15-ft [3- to 4.6-m] water depth, approximately 450 ft [137 m] off shore). The land end of the cable would be fastened to a cable sled to protect the cable from entangling with undersea boulders while transiting through the surf zone (Figure 2-6b). The floats on either side of the sled would assure that the end of the cable floats on the surface as it is pulled to shore. The skid plate on the bottom of the sled would assist in pulling the cable over the exposed rip-rap and boulders that are in shallow water. Small floats would be attached to the cable along its length as it is pulled toward shore to assure that the cable does not contact or drag along the bottom. The sled would be pulled to shore with a wire winched from the cable-laying vessel and guided by the long arm of a crane positioned on the revetment. After successful transit through the surf zone, the sled would be removed and the wire attached directly to the cable.

A turning sheave (right-angle guide), consisting of a 4-ft (1.2-m) wide by 1-ft (0.3-m) high concrete block, would be placed on shore one day prior to installation. The turning sheave allows the cable to turn through the angle from the landing point to the utility vault. Once the cable is temporarily secured at the anchor block, a crew at the vault would strip the armor layer from the cable and anchor it to the interior of the vault. Simultaneously, two other activities would occur: (1) a stopper would be placed on the cable to hold the cable and the first section of split pipe, and (2) divers would inspect the cable from the shoreline to approximately 500 ft (152.4 m) seaward of the initial mooring. The divers would remove the floats and guide the cable to the bottom, positioning it along the previously laid guide wire to assure that no living coral are damaged.

The vessel would then move seaward from the shore, deploying the cable as it follows the pre-planned cable route. The vessel's linear cable winch would allow the cable to be laid with either tension or slack to assist the divers in guiding the cable into position along the route marked by the wire rope. Once the vessel has reached the site of buoy number 1, the end of the cable would be lowered to the bottom.

The undersea cable would be anchored along its entire length by either rock bolts or protective split pipe, with the type of anchoring and spacing dependent upon the environmental conditions (e.g., the substrate) (Figure 2-2). The route selected avoids areas of vertical relief to the maximum extent practicable and utilizes branches of sand deposit that extend seaward from the beach through the sand channel zone whenever possible (Appendix E).

Divers would set the bolts and encase the cable in the split pipe depending upon seafloor conditions. The hollow, self-securing rock bolts would be filled with water-sealing grout which would set within 24 hours. No trenching is required. Anchoring of the cable along its entire route may be completed following the initial day of installation. During installation, excess cable would be placed on the seafloor in a figure eight configuration between buoys number 1 and 2 and secured with rock bolts.

Cable Beach Anchor

Once on shore, the cable would be anchored in the natural basalt outcropping using rock bolts and secured to the entrance of the utility vault (Figures 2-9 and 2-10).

Utility Vault

The utility vault would be constructed off site and trucked in using an existing dirt roadway leading from the runway. A crane would be used to place the vault onto a maximum 6-in (152-mm) thick gravel bed covering a maximum 8- by 8-ft (2.5- by 2.5-m) area. The vault box would be installed shoreward of the beach area, above the high water mark, in the location shown in Figure 2-9.

Land Transmission Cable

No heavy equipment (e.g., crane and backhoe loader) would be used to lay the land transmission cable. To avoid sensitive resources in the project area, equipment would be confined to the existing dirt roadway to the staging area and proposed staging platform.

Buoy, Anchor, and Canister Installation

The final assembly of the WEC buoys and anchors would occur on O'ahu at either Honolulu Harbor or Barbers Point, which would serve as the initial staging area; all deployment activities and vessels would start out from this point. The selected site at MCBH Kaneohe Bay for the buoys and anchors would be pre-marked with a marking buoy and identified with latitude and longitude coordinates. The location would be pinpointed with Global Positioning System (GPS) navigational systems for accuracy. The actual method of deployment of the buoys and anchors is dependent on final design considerations and vessel capabilities.

The buoy and anchor would be ocean-towed, barged, or trucked from Honolulu Harbor or Barbers Point. The anchor may be trucked to Kaneʻohe Bay, as opposed to towed or barged, to avoid risk of damage to the buoy and anchor during towing and to avoid higher costs. After transport to Kaneʻohe Bay, the buoy and anchor may remain in the Bay overnight prior to installation. Prior to deployment, divers will choose the buoy and anchor locations and mark the sites with rock bolts that will be used to secure the anchors. At the deployment site, the ballast tanks in the anchor would be flooded with water and the anchor lowered to a pre-determined location on the seafloor. Tag lines running from the anchor to the rock bolts would be used to guide the anchor into position at the pre-selected site. Upon satisfactory positioning of the anchor base, a vessel would lower additional mass down onto the gravity base, and the anchor frame would be rock-bolted to the seafloor. Following anchor installation, the buoy column would be winched down from the deployment vessel and connected to the anchor base. Divers would assist in attaching the buoy column to the anchor.

The canister would be deployed separately from the anchor and buoy. It would be lowered with a winch to the seafloor and secured with rock bolts. Divers would connect electrical cables and hydraulic hoses to the canister.

2.4.1.4 System Monitoring and Protection

A monitoring plan would be developed for the project, subject to approval by the Navy. The WEC system would be monitored through a combination of automated systems and visual observations. An automated GPS system within each buoy would continuously provide location information and alert appropriate personnel if a buoy moves outside of a designated watch circle. The system would be automatically shut down by an on-board computer system should an electrical fault occur. The power system of the WEC system would be monitored through a variety of sensors allowing monitoring of key variables at the shore stations or via a modem. Presence of the system would be verified at least once every 24 hours through a visual inspection of the system and its navigational features. Each WEC buoy would have signage normally used by the USCG indicating, 'Government Property, Submerged Obstruction.' Buoys for the mooring clumps would likely be submerged.

Approximately once every two months, a diving inspection of the undersea systems would be conducted to observe and record system wear and to note potential safety issues not apparent from other visual and automated monitoring. The WEC system would also be inspected if the data acquisition and monitoring system indicates any abnormal operational parameters regardless of the time interval since the last inspection. Land based electrical equipment would be inspected on a routine basis, once per month or bi-monthly. Procedures for responding to critical alerts, in the case of a mooring break, electrical fault, or other alerts or maintenance observations, will be identified. Monitoring, protection, and response procedures will be identified in the WEC system operational monitoring and response plan to be approved by the Navy.

Finally, a Memorandum of Agreement (MOA) would be established between the ONR and MCBH Kaneohe Bay encompassing the WET project.

2.4.1.5 System Removal

Upon completion of the WEC system test, the equipment would be removed using operations similar to those used for installation. If the “ocean-towed” buoy and anchor system is used, the ballast tanks in the anchor would be filled with air and the buoy and anchor floated off the sea floor and towed to the staging area. If a non-floating gravity anchor is used, a barge or vessel with winches, a crane, or lift bags would be used to lift the system out of the water and return it to the staging area. A beneficial impact would result from the growth of benthic organisms such as corals on the WEC cable and anchor during the test period. In consultation with NMFS, USFWS, and DLNR, the Navy will determine at the end of the testing period whether the cable, buoy anchor system (from the universal joint down), and mooring clump base and anchoring system should be removed or left in place. All other WEC equipment (i.e., buoys, equipment canisters, and land based components) would be removed following completion of the test.

2.4.2 Alternative B: Pearl Harbor

Information for this alternative site was obtained from the following reports: *Final Environmental Impact Statement, Outfall Replacement for Wastewater Treatment Plant at Fort Kamehameha, Navy Public Works Center, Pearl Harbor, Hawaii* (Navy March 2001); *Pearl Harbor Naval Complex Integrated Natural Resource Management Plan* (Navy October 2001); and “Marine Natural Resources Insert for the WET EA” (Navy 2002a) (Appendix D).

2.4.2.1 General Description and Site Selection Factors

The Pearl Harbor site meets all of the project objectives identified in Section 1.3 and Table 2-1. As with MCBH Kaneohe Bay, this site is conducive to installation of multiple buoys, presenting the opportunity to observe the effects of more than one buoy on system performance. It provides good access for installation, operations, and maintenance activities, as well as power grid connections. The site, which is not a popular recreation area because of its location off of the Pearl Harbor entrance channel, is used primarily for military ship ingress and egress. The entire WEC system, including the buoy array, transmission cable, and shoreside equipment, would be within a restricted area, minimizing risks to system security.

Despite these favorable conditions, the Pearl Harbor site was not selected because it would provide only a minimal wave energy environment to test the WEC technology and is considered impractical. The site is exposed to waves with average heights in the range of the minimum 3 ft (1 m) and less than the optimum 5 ft (1.5 m). In addition, the site is relatively sheltered from winter storms, and the likelihood that the system would be challenged by storm conditions within the two- to five-year test period is low.

At the Pearl Harbor site, the undersea cable would be secured to the western side of the Pearl Harbor entrance channel along the side of the channel (Figure 2-11). The landing site would be located on the shoreline adjacent to Building 562. Installation of the buoy system would be conducted over a two- to five-year period, as described in Sections 1.1 and 1.3.

2.4.2.2 WEC System Components

The system components would essentially remain the same as those described in Section 2.4.1.2. There could be modifications to the design of certain components such as the anchoring of the undersea cable, buoys, and equipment canister relative to substrate found at the site. The equipment shelter would be housed at Building 562, on the west shore of the entrance channel.

2.4.2.3 Installation Procedures

Installation procedures would be similar to those described in Section 2.4.1.3. Installation operations would be coordinated with the appropriate authorities to avoid interference with harbor operations.

Undersea Transmission Cable

Installation procedures for the undersea transmission cable would be similar to those described in Section 2.4.1.3, however, they would be modified for site requirements unique to the Pearl Harbor location (e.g., type of anchoring and spacing needed to secure the cable).

Cable Beach Anchor

A concrete block would be placed on the lawn of Building 562 near the cable landing site to anchor the cable.

Utility Vault

The prefabricated concrete utility vault would be housed near Building 562.

Land Transmission Cable

The land transmission cable would be encased in a PVC conduit and follow the perimeter of Building 562 from the utility vault to the area designated as the equipment shelter (Figure 3-6). Heavy equipment would be used for installation as described in Section 2.4.1.3.

Buoy, Anchor, and Canister Installation

The final assembly of the WEC buoys and anchors would occur on O‘ahu at either Honolulu Harbor or Barbers Point, which would serve as the initial staging area; all deployment activities and vessels would start out from this point. The proposed buoy array site at Pearl Harbor would be pre-marked with marking buoys and identified with latitude and longitude coordinates. The location would be pinpointed with GPS navigational systems for accuracy. The actual method of deployment of the buoys and anchors is dependent on final design considerations and vessel capabilities.

The buoy and anchor would be ocean-towed, barged, or trucked from Honolulu Harbor or Barbers Point. Installation procedures would be similar to those described for the Proposed Action.

2.4.2.4 System Monitoring

Monitoring of the system components would be conducted as described in Section 2.4.1.4.

2.4.2.5 System Removal

System removal would be conducted as described in Section 2.4.1.5.

2.4.3 Alternative C: No Action

The No Action alternative would not implement the proposed WET test in Hawai‘i. With the No Action alternative, the Navy would neither satisfy stipulations of the Congressional appropriation nor meet the stated objectives (purpose) of the Proposed Action in Section 1.3. The No Action alternative would not prohibit testing of the WEC system elsewhere in the world. However, OPT would have to find another location, outside of Hawai‘i, to test the WEC system in a high average annual wave density environment.

2.5 SUMMARY OF THE PREDICTED ENVIRONMENTAL EFFECTS OF THE PROPOSED ALTERNATIVES

Table 2-2 presents a summary of project alternatives that were considered and their predicted environmental effects.

Table 2-2. Comparison of Predicted Environmental Effects

Potential Issue/ Impact	Alternatives		
	MCBH Kaneohe Bay Alternative A	Pearl Harbor Alternative B	No Action Alternative C
SHORELINE PHYSIOGRAPHY			
Impacts of installation and operation	No significant impacts are expected. The WEC system would not alter currents or wave directions and there would be no effects on shoreline erosion or sand deposition patterns. Mitigation: none proposed.	Same as Alternative A	No Impacts
Impacts of system removal	No significant impacts are expected. In consultation with the NMFS, USFWS, and DLNR, the Navy would determine at the end of the test period whether equipment installed on the seafloor should be removed or left in place. Land equipment would be removed. Mitigation: none proposed.	Same as Alternative A	No Impacts
OCEANOGRAPHIC CONDITIONS			
	No significant impacts are expected. Implementing the WET test would not affect wave scattering and energy absorption. Mitigation: none proposed.	Same as Alternative A	No Impacts
MARINE BIOLOGICAL RESOURCES			
Impacts to threatened and endangered species and marine mammals protected under the MMPA during installation and operation of the WEC system	No significant impacts are expected. The USFWS and NMFS concur that the Proposed Action is not likely to adversely affect threatened (green sea turtle) and endangered species (hawksbill turtle, humpback whale, and Hawaiian monk seal) under their jurisdictions. Protocols for avoiding impacts to listed protected species during installation activities would be specified in the construction contractor's Best Management Practices (BMPs). The taking of marine mammals protected under the MMPA is unlikely. Mitigation: none proposed.	If selected, the Navy would initiate informal Section 7 ESA consultation. The taking of marine mammals protected under the MMPA is unlikely. Mitigation: none proposed.	No Impacts

Table 2-2. Comparison of Predicted Environmental Effects *(continued)*

Potential Issue/ Impact	Alternatives		
	MCBH Kaneohe Bay Alternative A	Pearl Harbor Alternative B	No Action Alternative C
MARINE BIOLOGICAL RESOURCES <i>(continued)</i>			
Impacts of installation and anchoring on coral and benthic communities	No significant impacts are expected. Minor impacts would occur on coral and benthic communities along the proposed cable route and at the buoy array site. However, installation of the WEC system has been planned to avoid areas with high percentages of coral coverage. Mitigation: none proposed.	Minor impacts on coral and benthic communities would occur along the cable route. Installation would avoid areas with a high percentage of coral coverage. The buoy array site is essentially devoid of live coral. Mitigation: none proposed.	No Impacts
Impacts to HAPC	The site is not within an HAPC. Mitigation: none proposed.	Same as Alternative A	No Impacts
Impacts to marine mammals or turtles from the risk of entanglement with the cable and entrapment within the buoy	No significant impacts are expected. Entanglement would be a minimal concern as cable installation would occur in shallow water with adequate tension to allow the torque-balanced cable to resist forming loops and contour to the seafloor. Divers would inspect the cable route once it is placed. Entrapment of marine mammals or turtles within the buoy would be of minimal concern since the interior of the structure is free of obstructions, sharp edges or corners. As part of the systems monitoring plan to be developed by the Navy, the system will be examined for entrapment of marine species. Mitigation: none proposed.	Same as Alternative A	No Impacts
Impacts to marine life from exposure to EMR	No significant impacts are expected. The small scale and limited area of disturbance indicate that impacts from EMR on marine organisms would be minor. Impacts of EMR on marine organisms can be expected to range from no impact to avoidance (for bottom-dwelling organisms only) of the vicinity of the WEC cable. Mitigation: none proposed.	Same as Alternative A	No Impacts

Table 2-2. Comparison of Predicted Environmental Effects *(continued)*

Potential Issue/ Impact	Alternatives		
	MCBH Kaneohe Bay Alternative A	Pearl Harbor Alternative B	No Action Alternative C
MARINE BIOLOGICAL RESOURCES <i>(continued)</i>			
Impacts to marine life and divers from potential electrical current leakage	No significant impacts are expected. In the unlikely event that damage to the cable causes an electrical fault, transient effects to marine organisms and divers (mild discomfort) could occur. Electroreceptive species would likely detect the field and be diverted away from the vicinity of the fault during the short period while the ground fault system actuates. Mitigation: none proposed.	Same as Alternative A	No Impacts
Impacts to marine life from potential heat release	There would be no impacts to marine life from potential heat release. Mitigation: none proposed.	Same as Alternative A	No Impacts
Impacts to marine life from noise generated by the system	No significant impacts are expected. Installation noise produced by drilling holes for rock bolts would be localized, intermittent, and of short duration. Operation of the WEC system is expected to produce a continuous acoustic output similar to, but in a higher frequency of, ship traffic. It is unlikely that noise from system installation or operation would have adverse impacts on humpback whales, dolphins, and green sea turtles. The USFWS and NMFS concur with the Navy that the Proposed Action is not likely to adversely affect threatened or endangered species. The taking of marine mammals protected under the MMPA is unlikely during the installation and operation of the WEC system. Mitigation: none proposed.	Same as Alternative A	No Impacts
TERRESTRIAL BIOLOGICAL RESOURCES			
	No threatened or endangered species exist on the proposed project site. Mitigation: none proposed.	Same as Alternative A	No Impacts

Table 2-2. Comparison of Predicted Environmental Effects *(continued)*

Potential Issue/ Impact	Alternatives		
	MCBH Kaneohe Bay Alternative A	Pearl Harbor Alternative B	No Action Alternative C
LAND AND MARINE RESOURCE USE COMPATIBILITY			
	No significant impacts to land and marine resource use are anticipated. Marine resource use incompatibility at the offshore buoy array may result in system security risks. The area is currently open to public access for fishing, boating, and diving. Presently, there are no plans to restrict public access to the buoy array site. The project would not interfere with mission operations at MCBH Kaneohe Bay Mitigation: none proposed.	No significant impacts to land and marine resource use are anticipated. The proposed project would not interfere with mission operations at Pearl Harbor. Mitigation: none proposed.	No Impacts
CULTURAL RESOURCES			
	There would be no effect on historic properties and no impacts to areas within the Mokapu Burial Area (MBA), NRHP Site 50-80-11-1017, where Native Hawaiian human remains are likely to be found. The Hawaii SHPO was consulted on the Proposed Action and concurred with the Navy's finding of no historic properties affected. Mitigation: none proposed.	No impacts on the Pearl Harbor National Historic Landmark. No other cultural resources present. Mitigation: none proposed.	No Impacts
INFRASTRUCTURE			
	No impact Mitigation: none proposed.	Same as Alternative A	No Impacts
RECREATION			
	There would be impacts to recreation outside the 500-yd (457-m) buffer imposed by the presence of the buoy array during the two- to five-year project duration. These impacts would not be significant. Mitigation: none proposed.	No impacts to recreation because the area is used primarily for military ship ingress and egress and the area is off-limits to public access. Mitigation: none proposed.	No Impacts

Table 2-2. Comparison of Predicted Environmental Effects *(continued)*

Potential Issue/ Impact	Alternatives		
	MCBH Kaneohe Bay Alternative A	Pearl Harbor Alternative B	No Action Alternative C
PUBLIC SAFETY			
	<p>There would be potential impacts to public safety outside the 500-yd (457-m) buffer imposed by the presence of the buoy array during the two- to five-year test period.</p> <p>Mitigation: Each buoy would have safety lights and standard USCG signage. The system would be monitored through a combination of automated system and visual observations. A response plan would be developed.</p>	<p>No impacts to public safety because the area is off-limits to public access.</p> <p>Mitigation: similar to Alternative A.</p>	No Impacts
VISUAL RESOURCES			
	<p>Impacts on scenic views would be minimal. Navigational aids from the buoys would extend approximately 30 ft (9 m) above sea level. At night, safety lights on the navigational aids would be visible in the distance.</p> <p>Mitigation: none proposed.</p>	Same as Alternative A	No Impacts

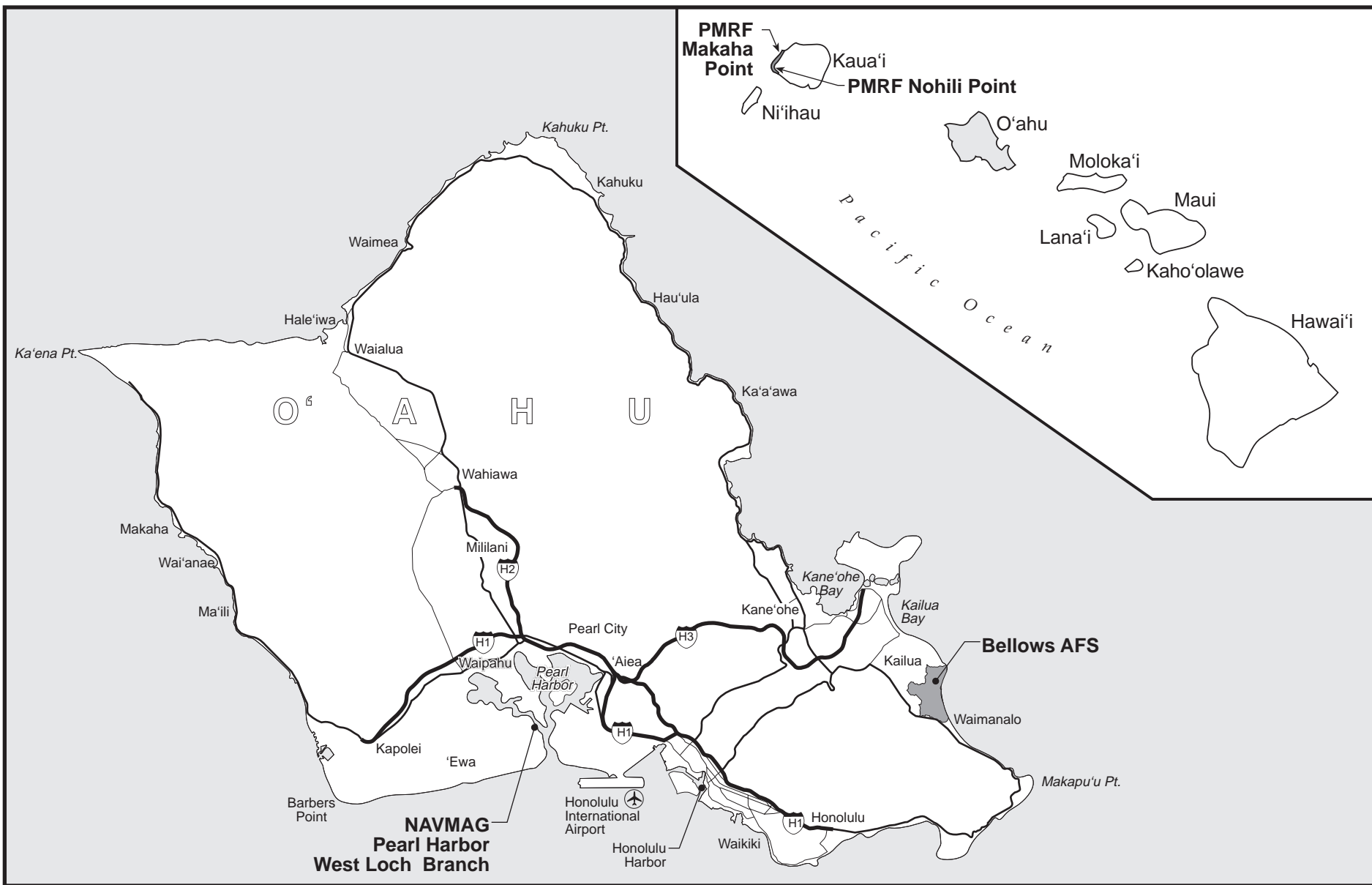

0 1 2 3 4 8
 SCALE IN KILOMETERS

0 1 2 3 6
 SCALE IN MILES

Figure 2-1
ALTERNATIVE SITES CONSIDERED

Environmental Assessment
 Wave Energy Technology Project

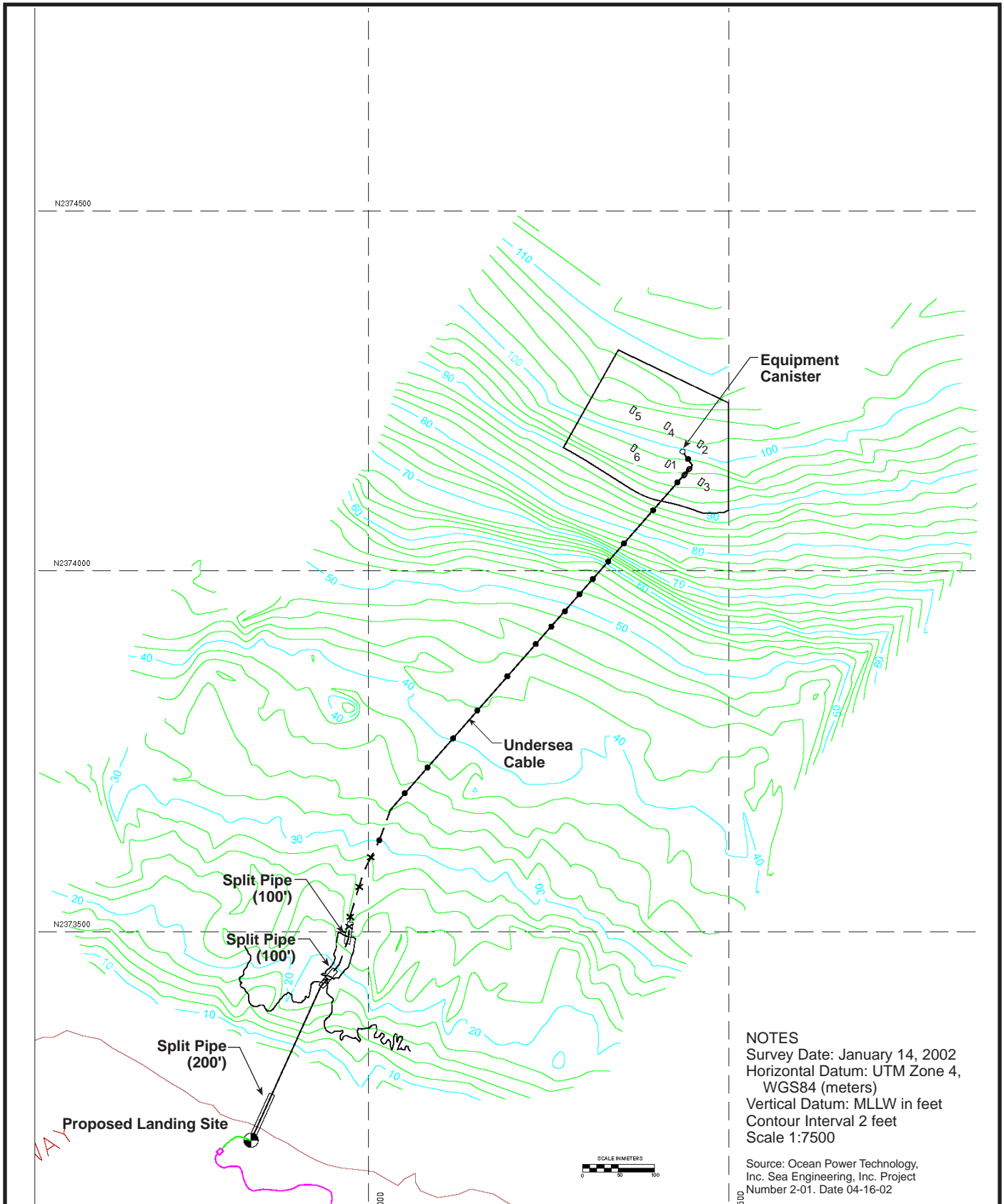

NOTES
 Survey Date: January 14, 2002
 Horizontal Datum: UTM Zone 4,
 WGS84 (meters)
 Vertical Datum: MLLW in feet
 Contour Interval 2 feet
 Scale 1:7500

Source: Ocean Power Technology,
 Inc. Sea Engineering, Inc. Project
 Number 2-01. Date 04-16-02

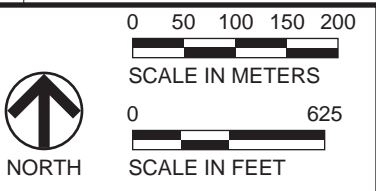

LEGEND
 Rectangles represent the approximate anchor base.
 Numbers indicate order in which buoys would be installed.

Figure 2-2
UNDERSEA CABLE ROUTE AND
WAVE BUOY ARRAY
North Beach, MCBH Kaneohe Bay
 Environmental Assessment
 Wave Energy Technology Project

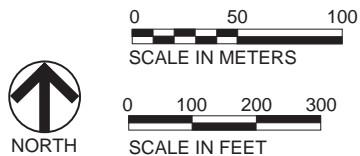
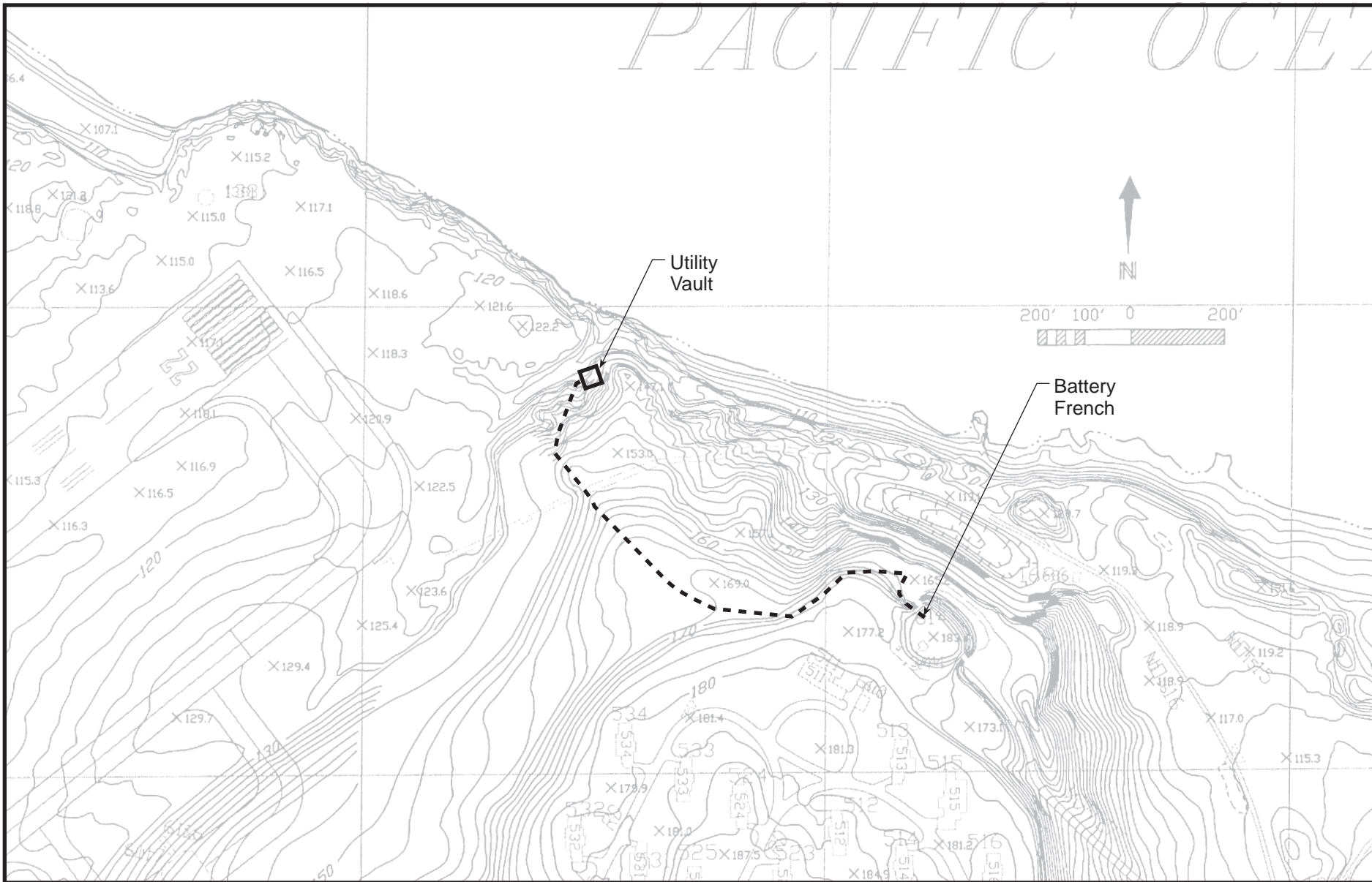

Figure 2-3
LAND TRANSMISSION CABLE ROUTE
North Beach, MCBH Kaneohe Bay

Environmental Assessment
 Wave Energy Technology Project

MAIN FEATURES

CYLINDRICAL STEEL BUOY
MASS 24-TON (22 METRIC TONS)
TO 35-TONS (32 METRIC TONS)

OPERATES 3 FEET (1.0 m) TO 13 FEET
(4.0 m) BELOW SURFACE

NOMINAL SYSTEM OUTPUT: 20kW

MOORING
RIGID SPAR BUOY WITH UNIVERSAL
JOINT AT BASE

DEADWEIGHT AND GROUTED ROCK
ANCHORS PROVIDE UP TO 100-TON
(91 METRIC TONS) HOLDING FORCE

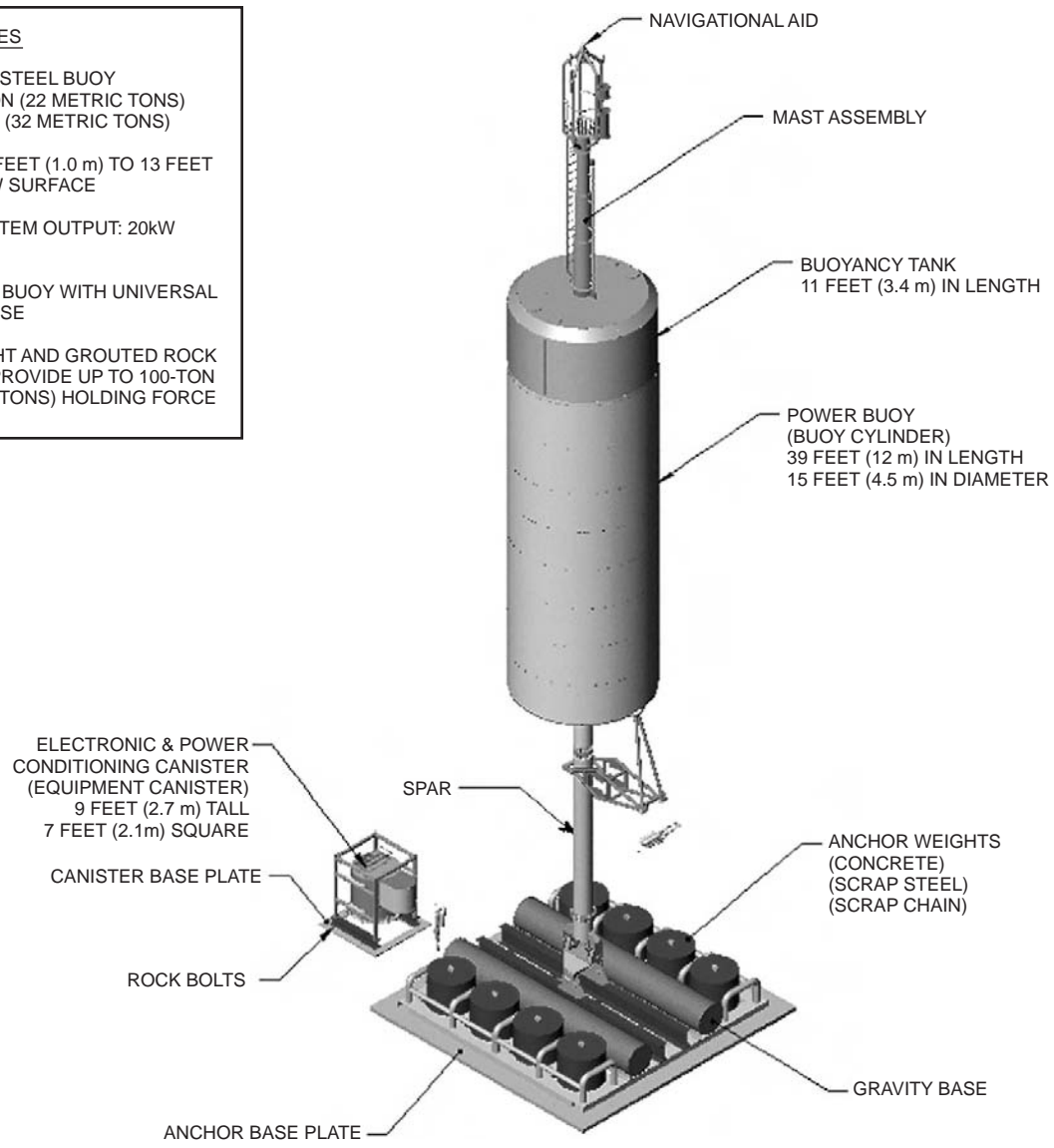

Figure 2-4
BUOY, ANCHOR AND CANISTER CONFIGURATION

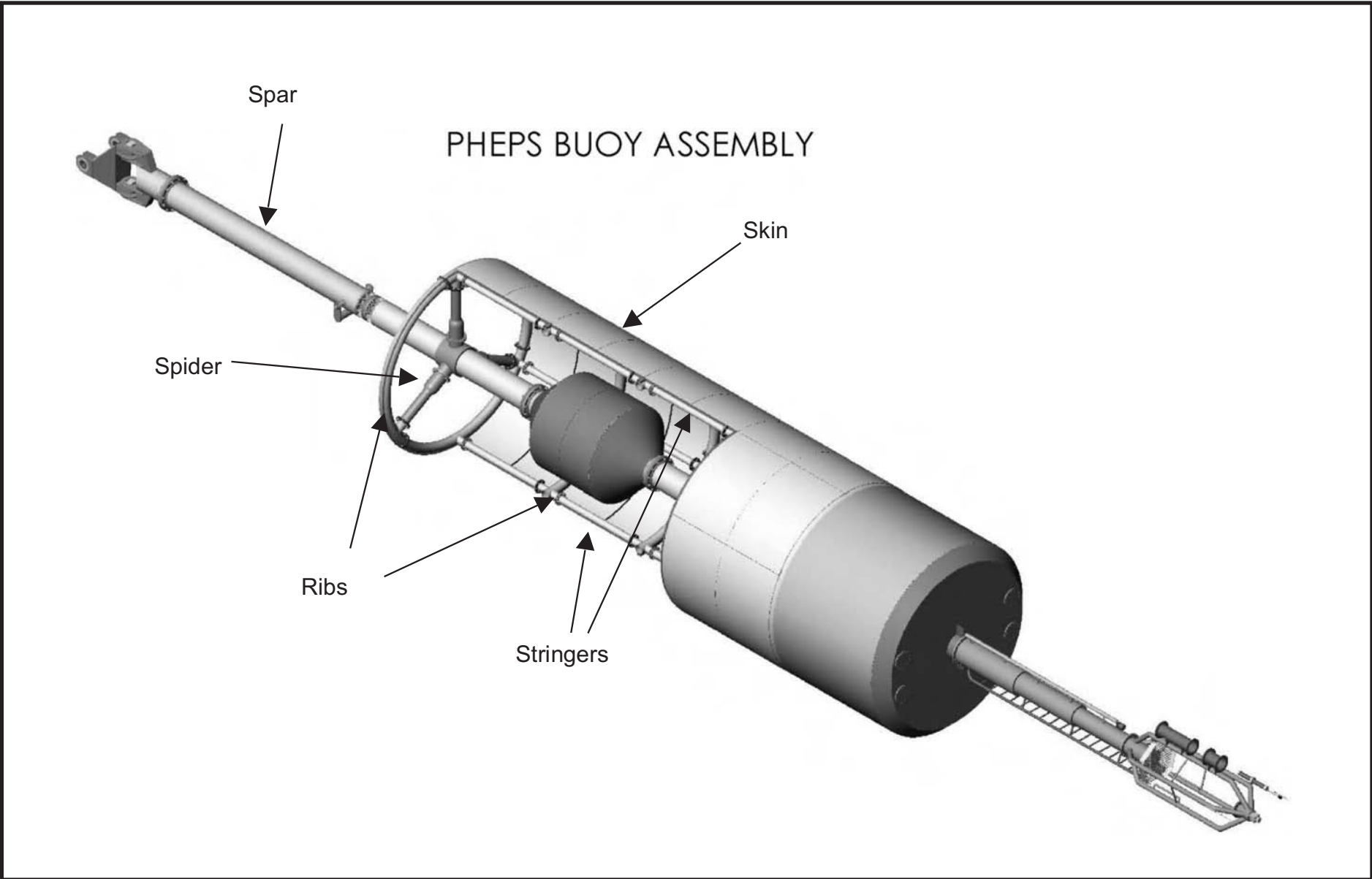
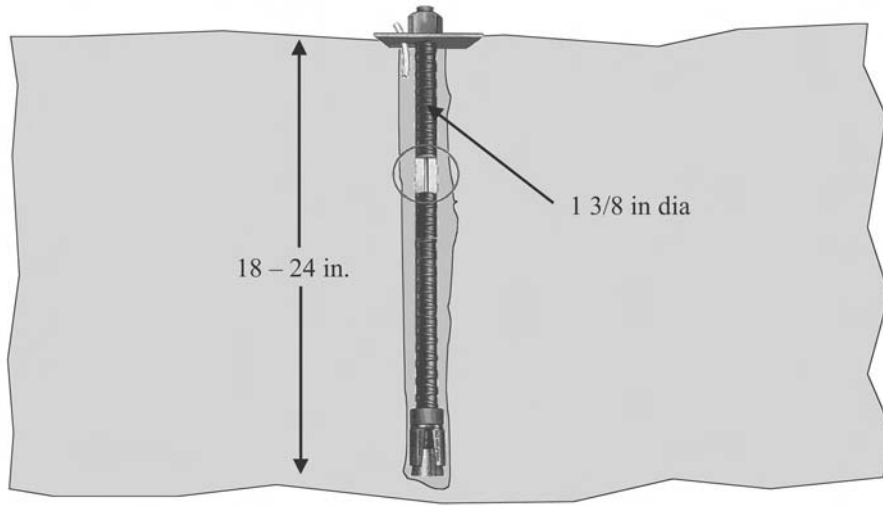

Figure 2-5
CROSS-SECTION OF WEC BUOY

GROUTED ROCKBOLT



CABLE SLED

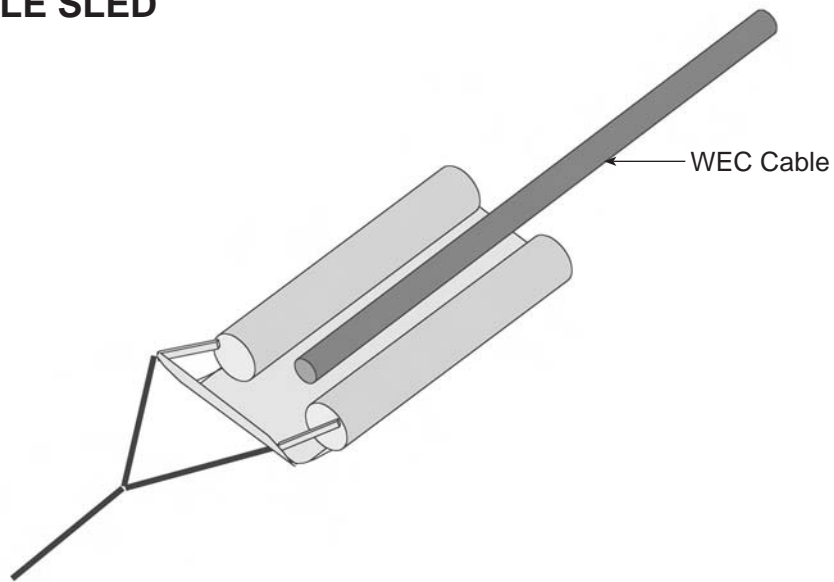
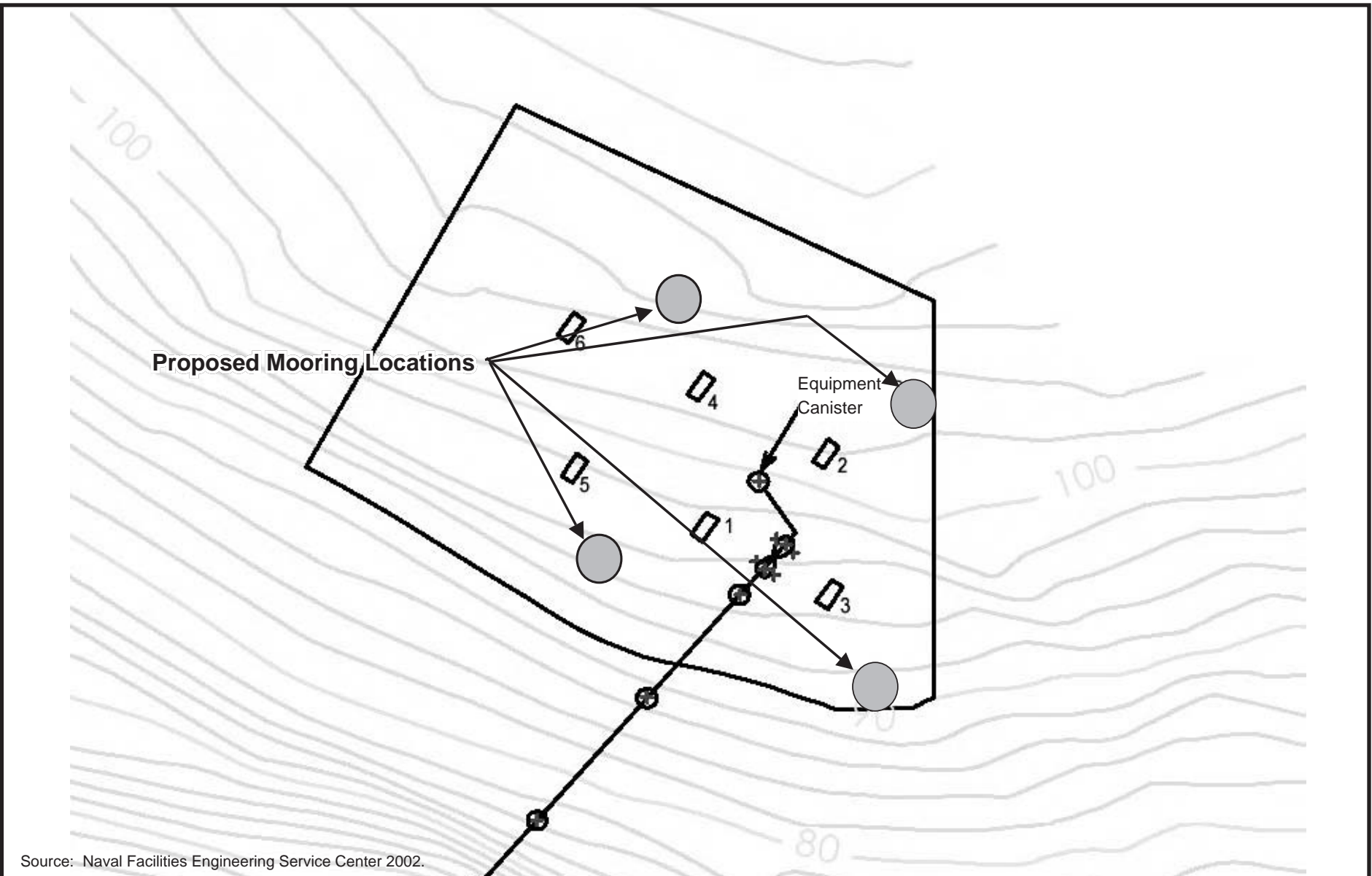

Figure 2-6
GROUTED ROCKBOLT AND CABLE SLED



Source: Naval Facilities Engineering Service Center 2002.

LEGEND

- Rectangles represent the approximate anchor base.
- Numbers indicate order in which buoys would be installed.

Figure 2-7
PROPOSED 4 POINT BOAT MOORING LOCATION

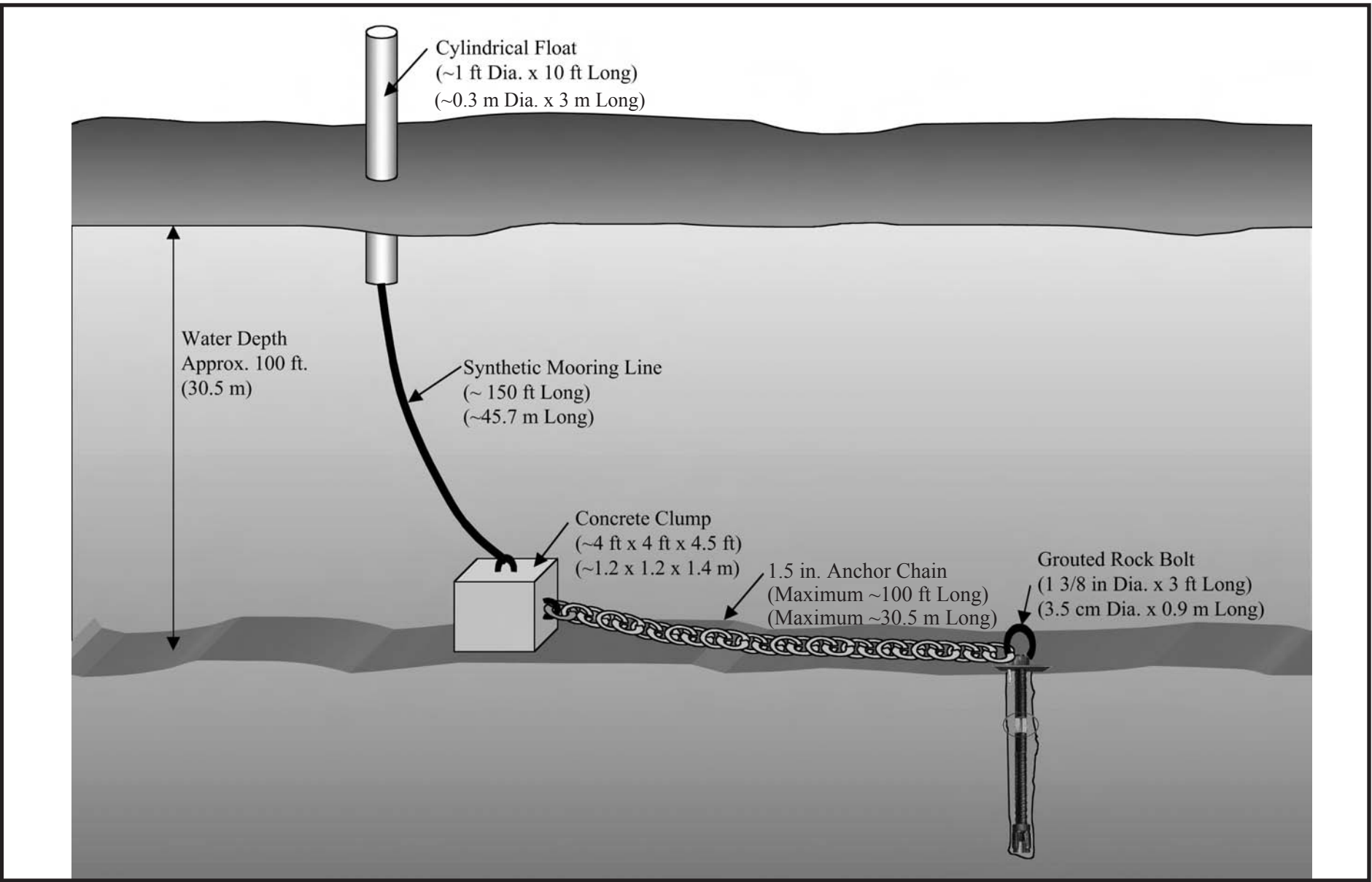

Source: Naval Facilities Engineering Service Center 2002.

Figure 2-8
WORK BOAT MOORING CONFIGURATION

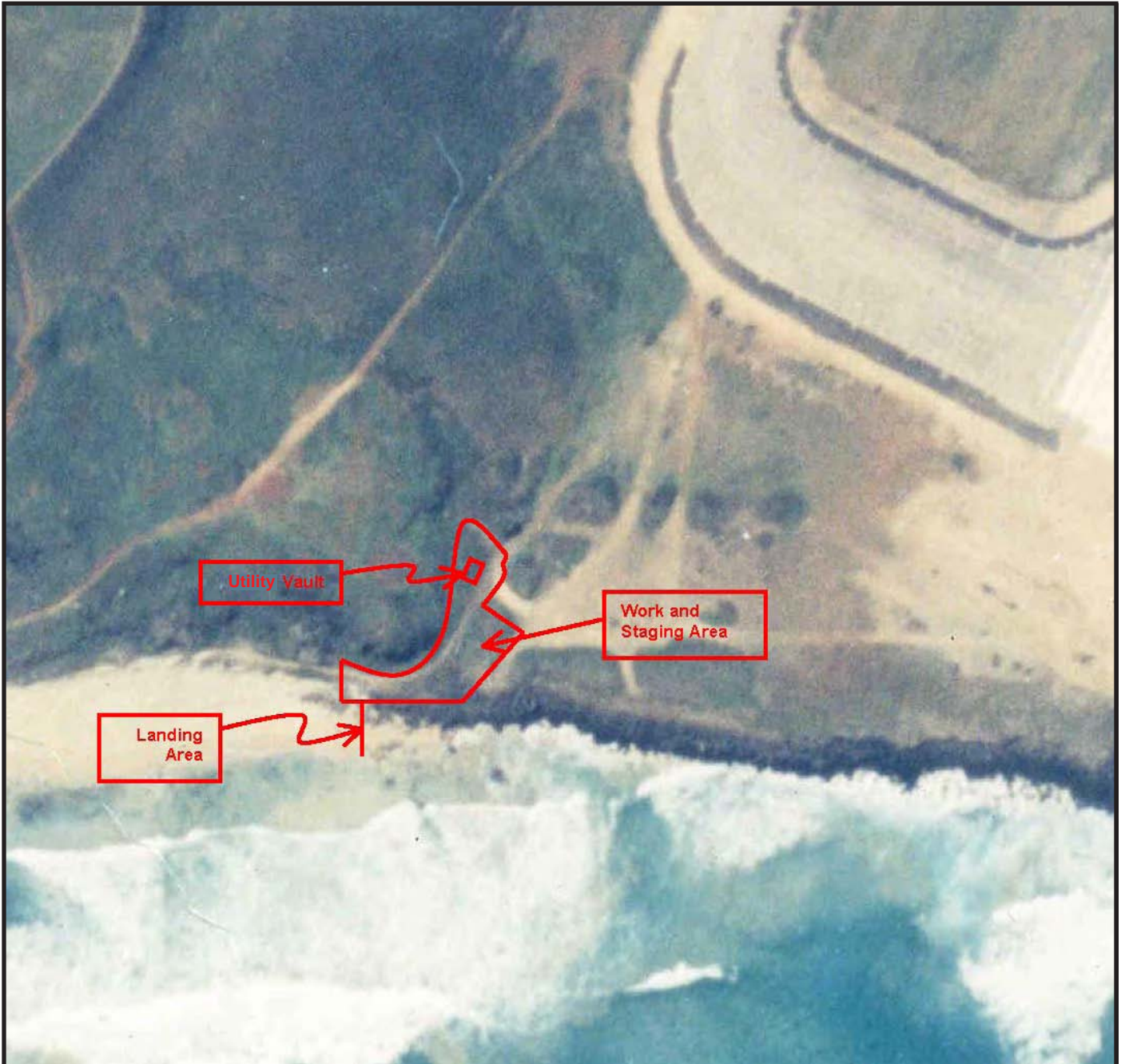

Utility Vault

Work and Staging Area

Landing Area



NORTH

0 25 50
APPROX. SCALE IN METERS

0 80 160
APPROX. SCALE IN FEET

Figure 2-9
CABLE LANDING AND STAGING AREA
North Beach, MCBH Kaneohe Bay

Environmental Assessment
Wave Energy Technology Project



Cable will be anchored
using rock bolts in the
natural basalt

Figure 2-10
LOCATION OF CABLE BEACH ANCHOR
North Beach, MCBH Kaneohe Bay

Environmental Assessment
Wave Energy Technology Project

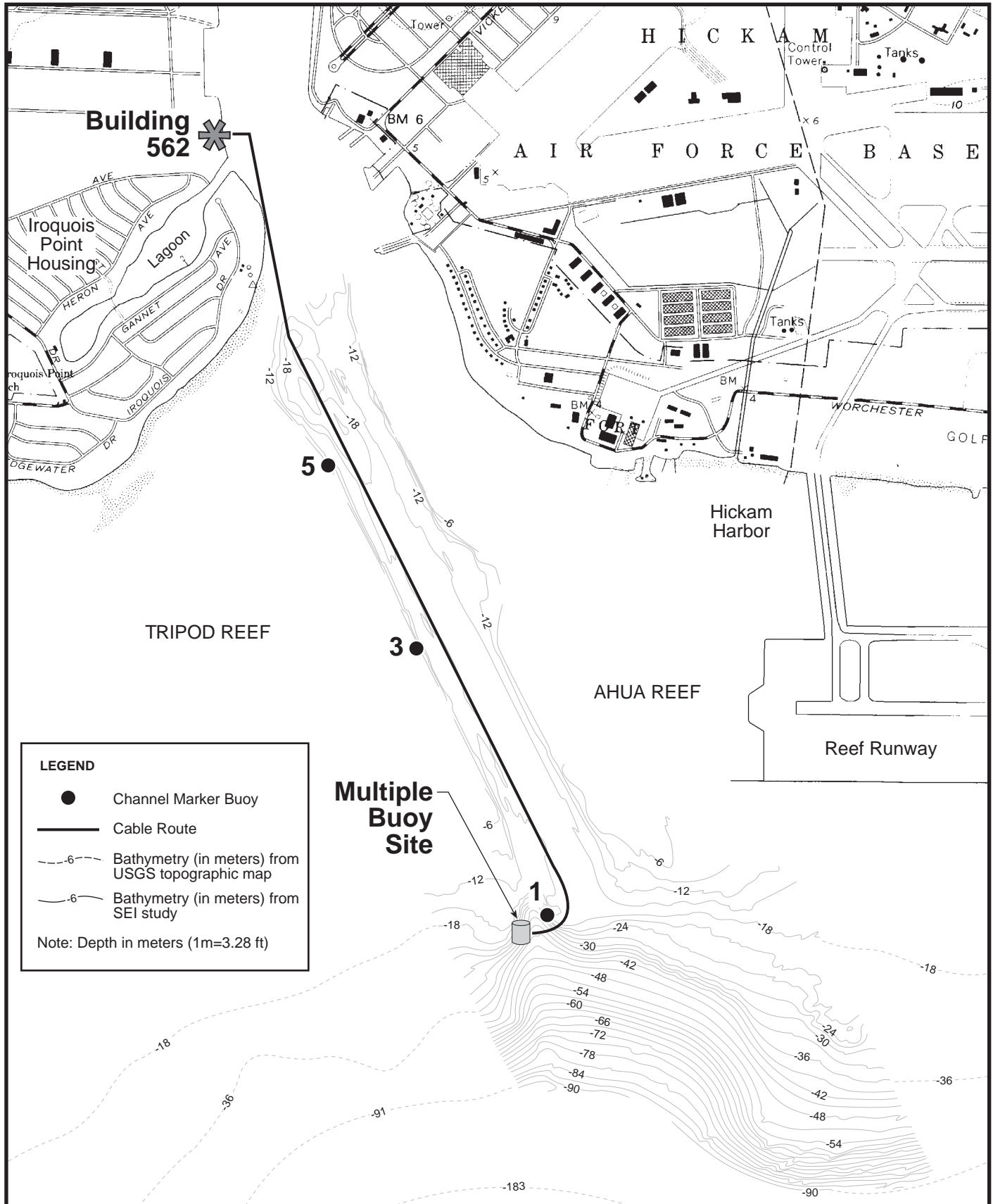

LEGEND

- Channel Marker Buoy
- Cable Route
- - -6 Bathymetry (in meters) from USGS topographic map
- 6 Bathymetry (in meters) from SEI study

Note: Depth in meters (1m=3.28 ft)

0 250 500
 SCALE IN METERS

0 500 1000 2000
 SCALE IN FEET

NORTH

Sources:
 Base map from Pearl Harbor 7.5 minute Quadrangle (USGS, 1983), Bathymetry from MCON Project P-497 Oceanographic Study for Outfall Expansion for Wastewater Treatment Plant at Fort Kamehameha (SEI, 1996)

Figure 2-11
UNDERSEA CABLE ROUTE AND
WAVE BUOY ARRAY
Pearl Harbor
 Environmental Assessment
 Wave Energy Technology Project

Chapter 3

Affected Environment

CHAPTER 3

AFFECTED ENVIRONMENT

3.1 INTRODUCTION

Chapter Three describes the affected environment and establishes baseline conditions that are compared to the alternatives in order to identify environmental consequences (Chapter 4). Relevant affected and non-affected resources are described for Alternative A: Proposed Action, Alternative B: Pearl Harbor, and Alternative C: No Action. Relevant affected resources include shoreline physiography, oceanographic conditions, marine biological resources, terrestrial biological resources, land and marine resource use compatibility, cultural resources, infrastructure, recreation, public safety, and visual resources. Relevant non-affected resources include climate and air quality, currents and tides, tsunamis, hurricanes, geology and soils, water quality, noise, electromagnetic radiation, and ordnance material.

3.2 DESCRIPTION OF RELEVANT AFFECTED RESOURCES – ALTERNATIVE A: PROPOSED ACTION

3.2.1 Shoreline Physiography

The proposed project area comprises a portion of MCBH Kaneohe Bay known as “North Beach” (Figure 1-2). The 8,000-ft (2,439-m) long beach is continuous except for a rock revetment protecting the seaward end of the main base runway. The 1,100-ft (335-m) revetment protrudes past the strip of sand beach into the ocean. West of the revetment, the 2,000-ft (610-m) shoreline is generally undeveloped. East of the revetment, North Beach extends 5,500 ft (1,676 m) east to the base of the cliffs of Ulupa‘u Head Crater. The average width of the beach is 50 to 60 ft (15 to 18 m). A band of sand dunes line the shore side of the beach, extending to a military housing development situated on a bluff over the easternmost 1,000 ft (305 m) of the beach. A 600-ft (183-m) rock and concrete revetment has been built at the east end of this section.

3.2.2 Oceanographic Conditions

Hawaiian waters consistently have some of the highest wave energy measured in the world. Four primary wave types are used to characterize Hawai‘i’s wave climate: (1) northeast trade wind waves, (2) north Pacific swell, (3) south swell, and (4) Kona storm waves.

Northeast trade wind waves are present throughout the year but are most frequent in summer months (May to October). They result from steady trade winds which blow from the northeast

over long stretches of ocean. Deepwater trade wind waves typically have periods⁶ of 5 to 8 seconds (s) and heights of 3 to 10 ft (1 to 3 m). The proposed project site is fully exposed to trade wind waves.

The north Pacific swell is produced by severe winter storms in the Aleutian area of the north Pacific and by mid-latitude, low-pressure atmospheric systems. North swells may arrive in Hawaiian waters throughout the year but are largest and most frequent during the winter months of October through March. These swells approach from the sector west through north, with periods of 13 s to 20 s and typical deepwater heights of 4.9 to 9.8 ft (1.5 to 3 m). The proposed project site is partially sheltered from the approach of the north Pacific swell and only the more northerly of these swells influence the area.

In addition to the two predominate wave types affecting Hawai'i's waters, tropical cyclones or hurricanes generate large waves that impact Hawai'i. Although infrequent, these waves present the worst-case conditions for most coastal areas. Analysis of the waves generated by two recent hurricanes that impacted O'ahu (Hurricane 'Iniki in 1992 and Hurricane 'Iwa in 1982) indicates that the waves approached from the southeast through west directions. The project site was relatively sheltered from severe waves during these two hurricanes.

Less intense low-pressure systems (cyclones) of subtropical origin, which usually develop northwest of Hawai'i in winter and move slowly eastward, are Kona storms. They are accompanied by southerly winds, from which the storm derives its name (Kona means "leeward" in Hawaiian), and by the clouds and rain that have made Kona storms synonymous with bad weather in Hawai'i (Atlas of Hawaii 1983). The project site is sheltered from direct Kona storm waves.

Wave heights measured during a 10-month period between August 2000 and June 2001 were extrapolated to the approximate conditions in 100 ft (30.5 m) of water at the project site (see Appendix E). The largest significant wave height was calculated to be 13.8 ft (4.2 m), with no severe storms or hurricanes occurring during the study period.

Estimates of extreme wave conditions, resulting from extreme wind waves and hurricane waves, predict maximum wave heights at the project site (a 100-ft [30.5-m] water depth) of 15.7 ft (4.8 m) and 44.6 ft (13.6 m), respectively.

Further information about the oceanographic conditions pertinent to the proposed installation of the WET system is provided in Appendix E.

3.2.3 Marine Biological Resources

The physical characteristics and associated marine biological resources of the nearshore ocean bottom off North Beach can be described by several bands, or zones, which approximately parallel the shoreline and are defined by water depth. The marine biological resources in the

⁶ A wave period is defined as the duration between two up- or two down-crossings of the mean sea level, e.g., the duration between two successive troughs or two successive crests.

nearshore ocean zones are described herein. Figure 3-1 provides a cross-sectional depiction of these zones. The general area of these zones relative to the depth contours are depicted in Figure 3-2. Further information regarding marine biota is provided in Appendices F and H.

3.2.3.1 Sand-Boulder Zone

The ocean bottom just seaward of the beach, from a depth of zero to approximately 12 to 15 ft (3.7 to 4.6 m), consists of a bed of coarse-grain carbonate sand that is kept in a state of continual resuspension by wave energy (see Appendix H, Figure 3). Interspersed on the sand bed are boulders that are continually swept by resuspended sand. Some of the boulder riprap that was used to construct the revetment securing the end of the runway has separated from the structure and is submerged in the nearshore area. The sandy area immediately off the base runway may shift seasonally, with the limestone outcrops alternately being buried and exposed. This zone ranges from a width of 400 ft (122 m) at the east end of the beach to 700 ft (213 m) near Pyramid Rock. As a result of continuous resuspension of sand with passing waves, the substrate from the shoreline through the sand-boulder zone contains little marine vegetation or coral.

No fish or other marine vertebrates were observed residing in the sand-boulder zone during the underwater site assessment. Green sea turtles (*Chelonia mydas*) are known to inhabit the waters around the project area and feed on *limu* (seaweed) growing near the shore. False green sea turtle nests (unfinished nest cavities) have been discovered in this zone. A dead hawksbill turtle (*Eretmochelys imbricata*) was reported on shore near the proposed project area. Hawaiian monk seals (*Monachus schauinslandi*) are occasionally sighted in the water and on shore near the project area. Humpback whales (*Megaptera novaeangliae*) have been observed in waters as shallow as 15 ft (4.6 m) and throughout the project area from November through April. Tail slapping, breaching, and pods are routinely observed off MCBH Kaneohe Bay shores. As many as 15 individuals have been observed at one time. On occasion, humpback whales have been observed in less than 15 ft (4.6 m) of water along the MCBH Kaneohe Bay coastline (MCBH 2002).

3.2.3.2 Sand Channel Zone

Farther offshore from the sand-boulder zone, the ocean bottom consists of consolidated limestone bisected by small channels, which vary in width and eventually end in ridge formations. These spur and groove formations are generally oriented perpendicular to the bottom contours and the shoreline. Generally 3 to 4 ft (0.9 to 1.2 m) of relief is present between the bottom of the channels and the adjacent ridges. While the channel bottoms typically consist of flat and scoured limestone with a thin veneer of sand, some live coral is present on the ridges. The sand channel zone transitions from the sand-boulder zone at approximately 12 to 18 ft (3.6 to 5.5 m) and extends to a depth of 30 to 35 ft (9 to 11 m).

The constant state of resuspension in the sand channel zone restricts settlement of bottom dwelling organisms on both the sand and limestone surfaces. Macrobiota observed in this zone were scattered heads of the branching coral *Pocillopora meandrina*, which grow along the vertical sides of the reef channels (see Appendix H, Figure 4).

3.2.3.3 Reef Flat Zone

Offshore from the sand channel zone, the emergent reef platform becomes more solid as sand cover decreases. The spur and groove formations end around the 30- to 35-ft (9- to 11-m) water depth, and the bottom from that point to approximately the 50-ft (15-m) depth is a wide plateau of relatively solid, flat limestone. Some scattered areas of vertical relief exist, generally due to potholing, coral growth, or the presence of small limestone ridges and ledges. The bottom slope in this zone is approximately 1 to 70 (rise to run).

The surface of the limestone reef flat consists of a short algal turf that binds a thin layer of carbonate sediment. Macrobiota in this zone include sporadic heads of the coral *P. meandrina* and flat encrustations of the corals *Porites lobata*, *Montipora capitata*, *Montipora patula*, and *Montipora flabellate* (see Appendix H, Figures 5 and 6). The dominant algae on the platform are clumps of the genera *Porolithon*. Coral growth is greater along the edge of the ledges than the flat areas, and fish are more likely to frequent the areas of coral growth. Colonies of the coral *Pocillopora eydouxi* up to 2 ft (0.6 m) in height occur infrequently in this zone; schools of alo‘ilo‘i or damselfish (*Dascyllus albisella*) reside within the coral. Damselfish are endemic to the Hawaiian Islands.

3.2.3.4 Escarpment Zone

The escarpment zone can be defined from the 50-ft (15-m) contour to approximately the 90- to 95-ft (27- to 29-m) depth contour. At a depth of 50 to 65 ft (15 to 20 m), the angle of the bottom increases 25 to 30 degrees. While there are bottom slopes (rise to run) as steep as 1 to 7, no prominent vertical ledges or wave-cut notches are present in the project area. The bottom is relatively flat limestone with widely scattered areas of vertical relief.

In many areas around O‘ahu, wave-cut notches at the 60-ft (18-m) depth, created during a lower stand of sea level, serve as preferred habitat for fish and turtles. These areas are considered HAPC. However, as described above, the project site seafloor at this depth (escarpment zone) does not have the characteristics of a wave-cut notch. Hence, the escarpment zone is not considered an HAPC.

The primary macrobiota on the escarpment is the flat encrusting coral *M. capitata*. In some localized areas, this species covers up to 50 percent of the substrate (see Appendix I, Figures 7 and 8). The following fish were observed in the escarpment zone during the underwater site assessments: ta‘ape or blue-lined snapper (*Lutjanus kasmira*), ala‘ihi or crown squirrelfish (*Sargocentron diadema*), yellowstripe squirrelfish (*Sargocentron ensiferum*), ‘u‘u or bigscale soldierfish (*Myripristis berndti*), kumu or whitesaddle goatfish (*Parapeneus porphyreus*), lauwiwili or milletseed butterflyfish (*Chaetodon miliaris*), kikakapu or multiband or pebbled butterflyfish (*Chaetodon multicinctus*), lau‘i pala or yellow tang (*Zebrasoma flavescens*), papio or ‘omilu or bluefin trevally (*Caranx melampygus*), and damselfish. Of these species, the milletseed butterflyfish, multiband butterflyfish, and damselfish are known to be endemic to the Hawaiian Islands.

3.2.3.5 Deep Reef Platform Zone

From the bottom of the escarpment zone, the bottom slopes gradually to a depth of approximately 100 ft (30.5 m) where it becomes almost featureless (Appendix H, Figure 9). There is a thin veneer of sand 1 to 2 in (25.4 to 50.8 mm) thick bound to the pitted, flat limestone surface by a thin veneer of algal turf in some areas. The bottom topography remains relatively constant and barren through the depth range of the zone.

The predominant macrobiota are scattered heads of the coral *P. meandrina* and flat encrustations of the coral *M. capitata*. Macrobiotic composition varies from relatively high coral cover above the 95-ft (29-m) depth contour to relatively little cover below this boundary. Other species known to transit the area at this depth include humpback whales, green sea turtles, and Hawaiian monk seals. Fish and turtle species tend to aggregate in areas of higher relief than that found in the proposed project area.

3.2.3.6 Undercut Ledges

At several locations at the eastern end of the deep reef platform, a system of small undercut ledges runs parallel to the depth contours (Figure 3-2). A ledge with an approximate length of 25 ft (7.6 m) exists at the 93-ft (28.3-m) depth and a 150-ft (45.7-m) long ledge system exists around the 100-ft (30.5-m) depth contour.

Increased populations of fish and coral occur around the ledges (Appendix H, Figure 10). Species of reef fish observed during the underwater site assessments included blue-lined snapper, squirrelfish, goatfish, milletseed butterflyfish, multiband butterflyfish, and yellow tang. The predominant coral was the encrusting form of *M. capitata*, which covered large areas of the upper lips of the undercut ledges.

Undercut ledges can be designated as HAPC; however, based on the relatively small size of these ledges, they would not fall under this classification (Appendix H). While several species of sea urchins are present along these undercut ledges, other invertebrates have not been identified in the area.

3.2.3.7 Threatened or Endangered Species

Species listed under the ESA as threatened or endangered, and listed as threatened or endangered by the State, include the threatened green sea turtle, endangered hawksbill turtle, endangered humpback whale, and endangered Hawaiian monk seal.

The green sea turtle occurs commonly throughout the Hawaiian Islands. While no turtles were observed during the underwater site assessments, existence of the green sea turtle and hawksbill turtle in the waters and nearshore areas around the project area has been documented (MCBH 2002; MCBH 2001). Preferred forage species of algae were not found in the proposed project area, and the physical structures of the reef surface in the project area are not considered preferred resting habitat for turtles.

Endangered humpback whales transit the project area seasonally. Humpback whale activity in the project area is described in Section 3.2.3.1.

Endangered Hawaiian monk seals have infrequently been observed near the project area. An average of three sightings a year occur on the shoreline and in nearshore waters. No monk seals were observed during the underwater site assessments for this proposed project.

3.2.3.8 Commercial, Subsistence, and Recreational Species

Fish such as ono or wahoo (*Acanthocybium solandri*), aku or skipjack tuna (*Katsuwonus pelamis*), and moano ukali-ulua or goat fish (*Parupeneus cyclostomus*) typically occur along the 100-ft (30.5-m) depth contour in the project area. For this reason, commercial, limited subsistence, and recreational fishing is conducted near the project area at this depth. The bottom conditions at the proposed project site do not offer unique habitat for species occurring in the area, and the site is not considered highly productive for spear fishing or uniquely attractive for SCUBA diving (Appendix I).

3.2.3.9 Marine Mammals

The MMPA protects any ocean dwelling mammal that primarily inhabits the marine environment. Within the proposed project area, Kaneohe Bay, mammals possibly present in the area and protected under the MMPA include the endangered Hawaiian monk seal, the endangered humpback whale, and various species of dolphin, as identified in Table 7-1 of Appendix F.

3.2.4 Terrestrial Biological Resources

3.2.4.1 Flora

Native seastrand vegetation and non-native koa haole (*Leucaena leucocephala*) shrub land are dominant plant communities along the proposed onshore cable route. Native sea strand vegetation occupies the undeveloped shorelines of North Beach and the cable landing site shoreward of the sandy beach. Native coastal plants such as naupaka (*Scaevola sericea*), pa'uohi'iaka (*Jacquemontia ovalifolia*), 'ilima (*Sida fallax*), hinahina (*Heliotropium anomalum* var. *argenteum*), and non-native species such as silky jackbean (*Canavalia sericea*) exist at the cable landing site. The primary vegetation along the length of the proposed route comprises koa haole shrub land (Figure 3-3) (MCBH June 1999 and 2001), which includes introduced grasses, koa haole, Christmas berry (*Schinus terebinthifolius*), sourbush (*Pluchea indica*), and Chinese violet (*Asystasia gangetica*).

3.2.4.2 Fauna

Waterbirds, migratory shorebirds, and seabirds frequent the shoreline of North Beach. 'Ua'u kani or wedge-tailed shearwater (*Puffinus pacificus chlororhynchus*) frequent the project area and

seasonally use the area for nesting burrows (MCBH 2002). Wedge-tailed shearwaters have been observed in the general vicinity of the cable route.

While wetlands and Wildlife Management Areas on the peninsula provide breeding habitat for waterbirds, no such habitat exists within the narrow corridor of the land cable route. Species of migratory birds observed along the project area shoreline include 'iwa or great frigate (*Fregata minor palmerstoni*), 'auku'u or black-crowned night heron (*Nycticorax nycticorax hoactli*), and kolea or Pacific golden plover (*Pluvialis fulva*).

Terrestrial mammals known to transit the project site include feral cats, dogs, mongoose, and rats.

3.2.4.3 Threatened or Endangered Species

Natural occurrences of plants currently listed or pending listing as threatened or endangered under the ESA or State law have not been observed on the proposed route for the land cable.

Several wetlands at MCBH Kaneohe Bay provide habitat for threatened and endangered waterbirds, including the ae'o or Hawaiian stilt (*Himantopus mexicanus knudseni*), 'alae 'ula or common moorhen (*Gallinule chloropus sandvicensis*), 'alae ke'oke'o or Hawaiian coot (*Fulica alai*), and koloa or Hawaiian duck (*Anas wyvilliana*). However, no threatened or endangered waterbirds have been identified in the proposed project area.

3.2.5 Land and Marine Resource Use Compatibility

The MCBH Kaneohe Bay property surrounding the proposed project area is varied in use and development. Along the shore, land use is designated as recreational with areas of open space and constrained open space along the onshore cable route. Existing uses include a golf course to the southeast of the project site, Officers' Family Housing atop the hillside directly south of the project area, and an aircraft runway to the south/southwest.

The offshore part of the proposed project area is located within the NDSA established by Executive Order 8681. MCBH Kaneohe Bay restricts access and use from shore to about 500 yards (457 m), an area designated as a Security Buffer Zone (hereinafter referred to as the 500-yd buffer zone). This zone is off-limits to public access (MCBH 1999). Active duty military personnel, MCBH civilian employees, retired members of the U.S. armed forces, reservists, families and sponsored guests are authorized to use North Beach, Pyramid Rock Beach, and the waters off the beach with the exception of a 300-ft (91-m) area on each side of the main runway. Other individuals or organizations must seek authorization from the Commanding General prior to accessing the area. Recreation along the shore and within the restricted access area is regulated by *MCBH Kaneohe Bay Base Regulations*, Chapter 11 Recreational Activities (MCBH 1999).

The area outside the 500-yd (457-m) buffer zone is subject to access limitation, but at the present time public access is unrestricted. Fishers, boaters, and divers currently use the area at which the buoy array is proposed.

The area outside the 500-yd (457-m) buffer zone is considered unrestricted waters open to public access. The proposed WEC buoy array site is currently used by fishermen, boaters, and divers.

3.2.6 Cultural Resources

Cultural resources the Proposed Action project area include one archaeological site, the Mokapu Burial Area, and one historic structure, Battery French. Much of the information provided below and additional information on these resources can be found in the Cultural Resource Management Plan for Marine Corps Base Hawaii, Kaneohe Bay (Schilz 1996).

Archaeological. The Mokapu Burial Area (Site 50-80-11-1017) is an extensive subsurface archaeological site containing ancient burials and funerary items. The site is listed in the NRHP and is recognized as being of religious and cultural significance to Native Hawaiians. The site is significant for its association with traditional Hawaiian burial practices, which occurred at this site over several hundred years and involved the interment of over 500 individuals. The site is also significant for the information it has yielded and is likely to yield that is important to understanding the prehistory of Mokapu and Hawai'i in general. The Mokapu Burial Area is situated on North Beach in a coastal dune setting that extends from Pyramid Rock in the west to Ulupa'u Head Crater in the east (Figure 3-4).

Projects involving excavation, archaeological testing, and archival research have identified certain clusters or loci within the NRHP boundary where native Hawaiian human remains were buried over a period of several hundred years (Tuggle 1999; Prishmont 2000, Figure 13). In addition, ground-penetrating radar technologies have identified areas within and beyond the NRHP boundary that are likely to contain archaeological deposits (Williams and Patolo 1998). Based on these studies, a revised site boundary has been proposed (Williams and Patolo 1998; Prishmont 2000).

The Proposed Action is partially located within the boundary of the Mokapu Burial Area site, although outside the identified burial clusters and outside the proposed revised site boundary. A portion of the project area crosses the west end of an area with low to moderate potential for human burials (Prishmont 2000, Figure 13). Dunes in this area that have potential for human burials are deep and covered by fill. The fill in this area is about 2 ft (0.6 m) deep and composed of sand mixed with basalt gravel, pebbles, cobbles, and boulders. The material has become cemented, creating a firm ground surface, rocky near the shore, with an overlying thin layer (3/4 to 2-1/3 in or 19.1 to 58.4 mm) of loose sand. The fill is thought to be associated with construction of the runway and revetment.

Historical. Battery 301 Forrest J. French (Site 50-80-11-1432) is a concrete structure built during World War II. The structure is partly covered by earth and has two turrets for 6-in guns. This structure is eligible for listing in the NRHP. It is significant for its indirect association to the December 7, 1941 attack and possibly as a distinct type of architecture (Schilz 1996). The interior was modified during the late 1960s and early 1970s to provide offices for the Naval Ocean Systems Center Laboratory. Battery French is currently not used, and the modified

interior has deteriorated. The basic structure and two gun turret foundations remain intact (Tuggle and Hommon 1986).

3.2.7 Infrastructure

The existing Battery French would be used to house the onshore electrical power and control equipment (see Section 2.5.1.1). The Battery has been tested for lead based paint and asbestos. A negative determination was provided for lead paint. Asbestos was detected only in the floor tiles and not in areas where project use is anticipated.

MCBH Kaneohe Bay purchases commercial power from the Hawaiian Electric Company (HECO). The Mokapu Substation is located near the main gate and contains two 10/12 megavolt-amperes (MVA) OA/FA⁷ (Delta-Wye) transformers, which step down a sub transmission voltage 46 kilovolts (kV) to the on-base primary distribution voltage of 11.5 kV.

MCBH Kaneohe Bay's primary electrical distribution system is operated as a radial power system. Each 10/12 MVA transformer supplies power to a single bus in each switching station located on base. There are four switching stations referred to as the Main Substation and Substation Nos. 1, 2, and 3.

The Main Substation, located next to the Mokapu Substation, contains three switchgear busses referred to as A, B, and C. Only A and B busses are being utilized; C bus is provided for future expansion in the event a third 10/12 MVA (HECO) transformer is required. All three busses can be connected in parallel via tiebreakers. HECO's transformers and the Main Substation's busses are normally not operated in parallel. From the Main Substation, power is distributed radially to three downstream switching stations via dedicated circuits, referred to as tie circuits. There are two tie circuits between the Main Substation and each downstream substation. Also, there are tie circuits between the substations that are normally opened.

Current billing shows that the peak load demand is 17,971 kW or 18,917 kilovolt-amperes (kVA) at 95 percent power factor on the Mokapu Substation. Analyzing the future worst-case scenario, where all the planned Military Construction (MILCON) and Non-Appropriated Fund (NAF) projects are constructed by FY2009, another 4,634 kVA is added to the existing peak load to estimate a future peak load demand of 23,551 kVA.

3.2.8 Recreation

Interviews with resident and military recreational users of the project area were used to characterize existing recreation. The survey area comprises the shore of MCBH Kaneohe Bay including North Beach, the seaward edge of the MCBH Kaneohe Bay main runway, Pyramid Rock Beach, and the waters approximately 1 mi (1.6 km) off this shore. Further details of recreational activities near MCBH Kaneohe Bay are provided in Appendix I.

⁷ OA/FA. Oil-cooled ambient/forced air (10 megavolt [MV] rating at OA, 12 MVA at FA)

Recreational activities in the vicinity of the project area include beachcombing, boating, bodysurfing, bottom fishing, jet skiing, kayaking, outrigger canoe paddling, sailing, trolling, surfing, swimming, sunbathing, pole fishing, thrownet fishing, spear fishing, and SCUBA diving (Figure 3-4). Commercial fishing within the restricted access area (500-yd [457-m] buffer zone) is prohibited unless approved by the Commanding General, MCBH Kaneohe Bay. Active duty military personnel and MCBH civilian employees may boat within the restricted area without written approval from the Commanding General, but all boats are subject to inspection.

The waters near the project area are also the primary transit corridor for boats traveling between Kaneohe Bay and Kailua Bay (two of the largest ocean recreation sites on windward Oahu). The area is also used by boats traveling to Kaneohe Bay from other parts of Oahu (Figure 3-4).

Trolling and bottom fishing are popular in the project area outside the restricted access area. The area around the 100-ft (30.5-m) depth contour is known as “Ono Run” for the ono, or wahoo, that are attracted to the ledge. Fishing also occurs for skipjack tuna, uku or gray snapper (*Aprion virescens*), goat fish, and other species.

The channel between Mokumanu (an island off Ulupa'u Head Crater) and Mokapu Peninsula is known as “The Slot.” It is a preferred route by boats transiting between the bays through the Sampan Channel. SCUBA diving boats frequently transit through the project area from Kaneohe Bay to dive locations in the waters off Mokumanu (Figure 3-4).

3.2.9 Public Safety

The following discussion on public safety is summarized from the public safety and recreational uses report provided in Appendix I. This report discusses interviews with emergency service providers and ocean users. The survey area comprises the area described for recreational activities.

Public safety considerations along the shore and within the nearshore portions of the project area are covered by *MCBH Kaneohe Bay Base Regulations*, Chapter 11 Recreational Activities (MCBH 1999). Lifeguards, security personnel from Waterfront Operations, and other security personnel from MCBH Kaneohe Bay enforce security in the restricted areas. Weather permitting, MCBH Kaneohe Bay lifeguards are on duty at North Beach and Pyramid Rock beach from 11:00 a.m. to 5:30 p.m. each day. Lifeguards have the authority to enforce laws and regulations pertaining to beach safety and patronage by authorized persons.

Public safety concerns are primarily related to poor signage identifying restricted areas and occasional high surf conditions. At present, this situation contributes to beachcombers, fishers, and surfers periodically entering the zone. During periods of high surf, powerful longshore currents, especially at Pyramid Rock Beach, occasionally sweep swimmers and surfers into the 300-ft (91-m) zone and off the rock revetment lining the main runway before lifeguards can reach them. High surf occurs during winter months when large north Pacific swells generate high surf conditions. High surf is also generated by less frequent large swells from the east or northeast.

Jurisdiction over marine safety issues in the offshore areas of the project area is shared between the Honolulu Fire Department (HFD) and the USCG. Generally, HFD responds to incidents within 3 mi (4.8 km) offshore, and USCG is responsible for emergencies beyond 3 mi (4.8 km) miles. However, the two agencies coordinate responses to public safety incidents. MCBH Kaneohe Bay lifeguards or Waterfront Operations personnel respond, if advised by HFD or USCG of a marine emergency.

3.2.10 Visual Resources

The Mokapu Peninsula is a very scenic and photogenic landscape, and the views from North Beach are quite remarkable. To the northeast, lies the Ulupa'u Head Crater (Figure 2-10). To the north is a view of unobstructed ocean (Figure 3-3). From the Officers' Family Housing area there is an impressive view of North Beach and Pyramid Rock (Figure 3-5).

3.3 DESCRIPTION OF RELEVANT AFFECTED RESOURCES – ALTERNATIVE B: PEARL HARBOR

Information in the sections below is based on the following reports: *Final Environmental Impact Statement, Outfall Replacement for Wastewater Treatment Plant at Fort Kamehameha, Navy Public Works Center, Pearl Harbor, Hawaii* (Navy March 2001); *Pearl Harbor Naval Complex Integrated Natural Resource Management Plan* (Navy October 2001); and “Marine Natural Resources Insert for the WET EA” (Navy 2002a) (Appendix D).

3.3.1 Shoreline Physiography

General site information for the WEC system at the Pearl Harbor location is shown in Figure 2-11. As shown in Figure 2-1, NAVMAG Pearl Harbor, West Loch Branch, fronts the Pearl Harbor entrance channel at the cable landing site for this alternative. The terrain is generally flat, ranging in ground elevation from 10 to 30 ft (3 to 9 m) above sea level, with a few sharp changes in grade occurring in abandoned quarry pits and local sinkholes. Much of the surface consists of broken to intact limestone.

Behind Building 562, the transition from groomed lawn to shoreline is delineated by a concrete berm. From the berm to the high tide line, the shoreline consists of a 10-ft (3-m) band of riprap covered with primarily non-native coastal vegetation. The proposed point of entry for the cable is adjacent to a dirt parking area and a concrete slab at the southern edge of the lawn.

3.3.2 Oceanographic Conditions

The open coastal waters in the vicinity of Pearl Harbor are subject to three types of large waves: southern swells, Kona storm waves, and hurricane-generated waves. However, Pearl Harbor is protected from ocean waves and swells because wave propagation through the 15,000-ft (4,570-m) long entrance channel is fully attenuated.

Southern swells generally occur in summer and early autumn and are generated by Antarctic winter storms. Wave heights are typically between 1 and 4 ft (.3 and 1.2 m), with periods of 14 s to 22 s (Atlas of Hawaii 1983). A description of Kona storm and hurricane-generated waves is provided in Section 2.2. At the proposed buoy location, wave heights are approximately 3 ft (1.5 m) for the majority of the year; however, heights of approximately 7 ft (2 m) do occur and are most frequent during the summer months (Navy 2002b).

3.3.3 Marine Biological Resources

The major components or zones of the Pearl Harbor entrance channel used to characterize marine biological resources are the channel bottom, channel slope, channel wall, fossilized reef platform, and sand-rubble zone, although components of the channel wall and fossilized reef platform are not present along the entire entrance channel. The proposed undersea cable route would be along the junction of the channel bottom and slope. The proposed location of the buoy array would be outside the entrance channel in the sand-rubble zone.

Marine biological resources in the Pearl Harbor entrance channel zones are described herein. Further information regarding marine biological resources is summarized in Appendix D.

3.3.3.1 Channel Bottom

The channel bottom is generally flat. From the mouth of the entrance channel seaward to approximately the #1 Channel Marker Buoy, depths increase gradually from about 45 ft (14 m) to 60 ft (18 m) (Figure 2-11). Southwest of the #1 Channel Marker Buoy, depths increase from about 60 ft (18 m) to 115 ft (35 m) over a distance of approximately 330 ft (100 m). The seafloor is comprised of calcareous sand and rubble, even along the steep slope. Moving farther offshore, the seafloor becomes coarser with increasing amounts of rubble. No cliffs or ledges are present in the areas proposed for the cable route and buoy array.

Naturally occurring sedimentation influences the composition of the Pearl Harbor benthic community. Reef building corals occur on the channel bottom; however, they are extremely sparse and cover only 0.13 percent (less than 1/7th of one percent) of the seabed (Appendix D). Ongoing studies being performed as part of the DoD Coral Reef Protection Implementation Plan appear to show that similar, very sparse coral development and algal growth are present on the west side of the channel bottom.

The total number of fish and diversity of species is low along the channel bottom. Sea grass is the most prominent channel bottom feature, primarily *Halophila decipiens*. Predominant invertebrates include the sea cucumber (*Ophiodesoma spectabilis*), sabellid or feather duster worms, serpulid worm tubes, and various benthic crabs and shrimp. Along the channel bottom, crab and shrimp burrows are present. Spotted eagle rays and schools of yellowfin goatfish (*Mulloidichthys vanicolensis*) have been observed feeding on the seafloor.

3.3.3.2 Channel Slope

The slope of the entrance channel varies throughout the length of the channel. Dead coral rubble and coarse calcareous sand dominate the slope. At the innermost portions of the channel's west slope, dead coral rubble and sand are overlain by substantial amounts of terrigenous material, such as leaf litter and mangrove propagules. Live coral cover in this area is extremely sparse. Sea urchins appear to be the dominant benthic invertebrate on most sections of the slope. The diversity of fish species is greater along the channel slope than on the bottom.

3.3.3.3 Channel Wall

The top of the channel wall begins at a depth of 6 ft (2 m) and runs to a depth of 20 ft (6 m). The wall occurs intermittently along the length of the entrance channel. The junction of the base of the wall and slope is generally less than 43 ft (13 m) in depth.

The wall is better developed on the west side of the channel than on the east, with many parts containing grottos and deep undercuts near its base. In some cases, these indentations extend back for over 6 ft (2 m). Large formations (up to 16 by 13 by 13 ft [5 by 4 by 4 m]) have broken off in some areas and settled less than 6 ft (2 m) from the wall, creating narrow passageways between the wall and the pieces of debris. Green sea turtles have been observed resting in recessions in the wall structure. Whitetip reef sharks (*Triaenodon obesus*) and reef blacktip sharks (*Carcharhinus melanopterus*) have also been observed in these grottos and undercuts along the channel wall.

Coral cover on the western channel wall increases dramatically in a seaward progression from the entrance channel. *M. patula* is the dominant coral growing in this zone (Navy 2002a). Additional coral species present include *P. lobata*, *Porites compressa*, *P. meandrina*, *Pavona varians*, *Montipora verrucosa*, *Montipora verrilli*, *Psammocora stellata*, *Fungia scutaria*, and *Leptastrea purpurea* (Navy March 2001, Appendix VII). The wall also provides substrate for a variety of sponges, alcyonarians, polychaete and sipunculid worms, and bivalve mollusks. The abundance and diversity of the flora and fauna increase in a seaward direction. The major families of Hawaiian reef fishes are represented in this zone.

3.3.3.4 Fossilized Reef Platform

The fossilized reef platform extends farther offshore on the west side of the entrance channel than on the east side. On the west side, the depth of the platform ranges from 6 to 20 ft (2 to 6 m), with modest spur and groove development on top of the platform at depths below 13 ft (5 m). On the east side, parts of the reef are exposed above the water at low tide, and introduced algae are dominant. Live coral cover is modest on most portions of the reef, although small areas on the west side support dense coral development. The dominant species are *P. meandrina*, *Montipora spp.* and *P. lobata*. Sessile and benthic invertebrate species are well represented. The major families of Hawaiian reef fishes are also represented in this zone; however, fish were not abundant in the area during previous surveys.

3.3.3.5 Sand-Rubble Zone

At depths below approximately 82 ft (25 m), the seafloor outside the entrance channel consists of loose sand deposits 10- to 30-ft (3- to 9-m) thick with occasional rubble outcrops. This sand-rubble zone is relatively devoid of living coral and algae. Fish observed in the sand-rubble zone include goatfish (*Mullidae*), wrasses (*Laborides phthirophagus*, *Pseudocheilinus octotaenia*, *Pseudojuloides cerasinus*), damselfish, and mackerel scad (*Decapterus macarellus*). Outer portions of this zone experience periodic scouring from the forces of storm waves acting on loose bottom rubble, with subsequent impacts on sessile organisms. The area considered for placement of the buoy array is within the sand-rubble zone and comprised almost entirely of coarse sand.

3.3.3.6 Threatened or Endangered Species

Species at the Pearl Harbor site listed as threatened or endangered under the ESA and State law include the threatened green sea turtle and endangered Hawaiian monk seal. Green sea turtles have been observed along the channel wall and fossilized reef platform. The Hawaiian monk seal has been recorded at Iroquois Point, located at the Pearl Harbor entrance channel. No observances of endangered hawksbill turtles have been reported.

An adult humpback whale and a calf were reported to have entered Pearl Harbor on March 21, 1998. However, this was a single and unusual event.

No HAPC are designated in the vicinity of the Pearl Harbor alternative location. Areas of rich biological diversity exist along the proposed cable route but these are localized and easily avoidable.

3.3.3.7 Commercial and Recreational Species

The native anchovy or nehu (*Encrasicholina purpurea*) is primary bait used in commercial aku fishing. The Navy issues permits for insured commercial aku boats to collect the nehu from certain regions of the harbor. Because the demand for nehu has decreased in recent years due to changes in the fishing industry, few fishermen or vessels use live bait for the capture of aku, and bait fishing in Pearl Harbor occurs on a reduced scale. The population status of nehu in Pearl Harbor is not known.

3.3.3.8 Marine Mammals

The MMPA protects any ocean dwelling mammal that primarily inhabits the marine environment. Within the proposed project area, Pearl Harbor entrance channel, mammals possibly present in the area and protected under the MMPA include the endangered Hawaiian monk seal, the endangered humpback whale, and various species of dolphin, as identified in Table 7-1 of Appendix F.

3.3.4 Terrestrial Biological Resources

3.3.4.1 Flora

The majority of terrestrial plant species that have been surveyed at the Pearl Harbor site are introduced or alien species. Several introduced plants have become common at Pearl Harbor, primarily low-growing species such as California grass (*Brachiaria mutica*) and pickleweed (*Batis maritima*). Original low-growing native vegetation, primarily sedges, herbs, and small shrubs, has been replaced by dense, woody stands of mangrove in the less developed areas of the estuary.

Native plant species observed along the shoreline at the Pearl Harbor site are milo (*Thespesia populnea*) and sea purslane (*Sesuvium portulacastrum*). Non-native vegetation includes sourbush (*Pluchea indica*), kiawe (*Prosopis pallida*), and mangrove (*Rhizophora mangle*).

3.3.4.2 Fauna

Two observed species of birds resident at the Pearl Harbor site are native, Pacific golden plover or kolea and the short-eared owl or pueo (*Asio flammeus sandwichensis*). Other observed resident species were introduced to the islands within the last century, including the red-vented bulbul (*Pycnonotus cafer*), chestnut mannikin (*Lonchura malacca*), spotted dove (*Streptopelia chinensis*), zebra dove (*Geopelia striata*), and Japanese white-eye (*Zosterops japonicus*).

The black-crowned night heron or 'auku'u is the only indigenous waterbird occurring at the Pearl Harbor West Loch area. Extensive mangrove and kiawe stands on the shorelines of West Loch provide potential nesting habitat for herons (Navy 1993). Migratory waterbirds and waterfowl considered indigenous to Hawai'i and associated with the Pearl Harbor Honouliuli Refuge include the green-winged (American) teal (*Anas crecca*), northern pintail (*Anas acuta*), northern shoveler (*Anas clypeata*), and lesser scaup (*Aythya affinis*).

Migratory shorebirds that seasonally occur in the area are the Pacific golden plover, sanderling (*Calidris alba*), ruddy turnstone (*Arenaria interpres*), and wandering tattler (*Heteroscelus incanus*). At least 30 additional species of straggler and vagrant shorebirds may occasionally occur in the area. The majority of birds found in developed areas, grasslands, and disturbed secondary forests are exotic or introduced (non-native) species. Among the most common species are the common myna (*Acridotheres tristis*), red-vented bulbul, Japanese white-eye, house finch (*Carpodacus mexicanus*), zebra dove, and cattle egret (*Bubulcus ibis*).

Species of mammals that exist at the Pearl Harbor site include the mongoose, rat, house mouse, and feral dogs and cats.

3.3.4.3 Threatened or Endangered Species

No Federally listed threatened or endangered flora have been reported in the area of Building 562, where the land cable route is proposed. Four Federally listed endangered waterbirds, the

Hawaiian stilt (ae‘o), common moorhen (‘alae ‘ula), Hawaiian coot (‘alae ke‘o ke‘o), and the Hawaiian duck (koloa), are observed regularly at the Honouliuli Unit of the Pearl Harbor Wildlife Refuge, located on the northwest tip of West Loch Branch. No critical habitat has been designated for these species.

Two additional bird species listed as threatened or endangered by the State but not the Federal government are occasionally found in the Pearl Harbor vicinity: the threatened white tern (*Gygis alba rothschildi*) or manu-o-Ku, and the endangered short-eared owl or pueo.

3.3.5 Land and Marine Resource Use Compatibility

The State classifies land at the Pearl Harbor site in the Agricultural and Urban Districts. Surrounding land use districts are Agriculture, Urban, and Conservation. The offshore area of the project site is restricted and off-limits to the public.

3.3.6 Cultural Resources

The Pearl Harbor site is situated within the Pearl Harbor National Historic Landmark boundary. The land segment of the project is in an area designated in the Pearl Harbor Naval Complex Integrated Cultural Resources Management Plan (ICRMP) as having no or low potential for archaeological deposits (Commander Navy Region Hawaii 2001, Figure 2).

Building 562, proposed as the shore-based equipment shelter, was constructed in 1980 and is, therefore, not considered to be a historic facility.

3.3.7 Infrastructure

The equipment shelter would be located in Building 562 on the west shore of the entrance channel (Figure 2-11). Electrical power is provided by the HECO Iroquois Point Substation, located at the entrance to the Iroquois Point Housing along Iroquois Drive. The electrical distribution system is at its capacity. The 10-MVA Iroquois Point Substation steps the 46-kV transmission voltage to 11.5-kV distribution voltage. The capacity of the main feeders is not documented. The recloser breakers at the substation are rated at 560 amperes (A). It is standard practice to set breakers to a rating equal or less than the capacity of the feeder line for the breakers to be effective; thus, it is likely that the feeders also have the same 10 MVA capacity of the substation. Voltage is further stepped down by individual transformers in the Iroquois Point distribution system to provide 277/480 and 120/208 voltage AC for user consumption. Power is distributed via overhead lines on power/telephone poles.

3.3.8 Recreation

Recreational use of the land portion of the Pearl Harbor site is limited to casual bird watching and nature study. Ocean activities at this alternative site include netting, fishing, trapping, tropical fish collecting, surfing, scuba diving, paddling, kayaking, and shelling. In 1999,

shoreline fishing at NAVMAG Pearl Harbor, West Loch Branch was banned and the permit system then in place was halted indefinitely. However, persistent subsistence fishing exists for several species of finfish and shellfish.

The Pearl Harbor entrance channel and the waters within the harbor are restricted to vessels owned and operated by military or DoD personnel under EO 8143, which prohibits civilian watercraft within Pearl Harbor unless authorized by the Navy. Authorized tour boats and military recreational boating are allowed in Pearl Harbor. The Pearl Harbor site is adjacent to the Iroquois Point Marina, which is for the exclusive use of Navy families residing at Iroquois Point housing.

3.3.9 Public Safety

Although a nearby refuge is periodically used for bird watching by Federal and State wildlife officials, as well as by members of the Hawaii Audubon Society, additional public access is discouraged for security and safety reasons. Shoreline fishing was banned at Pearl Harbor West Loch after the State Department of Health (DOH) issued: (1) an advisory warning against the consumption of fish and shellfish obtained from the Pearl Harbor Estuary, and (2) posted warning signs along the entire estuary shoreline alerting fishers of the advisory. Areas of Pearl Harbor have public use restrictions because of naval navigational concerns, explosive hazards, or security requirements.

3.3.10 Visual Resources

The Pearl Harbor site offers partial views of the Pearl Harbor Complex, Pearl City, 'Aiea, Halawa Heights, and the Honolulu skyline. The view outside the entrance channel to the south is open ocean. To the east are views of Hickam Air Force Base (AFB) and Honolulu International Airport, with the skyline of Honolulu in the distance. Northern views include the Pearl Harbor Complex, urban areas of 'Aiea, Halawa Heights, and Pearl City, with the Ko'olau Mountains in the distance. To the west the views include the 'Ewa Plain and the Wai'anae Mountains in the distance.

3.4 DESCRIPTION OF RELEVANT AFFECTED RESOURCES – ALTERNATIVE C: NO ACTION

As the test would not be conducted in Hawai'i, there would be no affected resources with this alternative.

3.5 DESCRIPTION OF RELEVANT NON-AFFECTED RESOURCES – ALTERNATIVE A: PROPOSED ACTION

3.5.1 Climate and Air Quality

The climate of Hawai‘i is influenced by its subtropical location, topography, and the surrounding Pacific Ocean. On O‘ahu, precipitation is primarily associated with the prevailing moisture-laden northeasterly trade winds that are intercepted and forced upwards at the Ko‘olau Range. Average annual rainfall at MCBH Kaneohe Bay is 40 in (1,016 mm), and the period of highest rainfall occurs between the months of October and April. Monthly average rainfall varies from 0.1 to 3.9 in (2.5 to 99.1 mm). Winds are predominantly northeast trade winds. During significant meteorological events such as tropical storms, winds of 25 knots (23.5 kilometers per hour [km/h]) or greater may occur (MCBH 2001).

Average temperatures on O‘ahu range from 72 degrees Fahrenheit (° F) (22 degrees Celsius [° C]) in January to 78.5°F (26° C) in August. Relative humidity ranges from a mean of 71.8 percent in December to a mean of 78.8 percent in March (MCBH 2001).

The U.S. Environmental Protection Agency (EPA) characterizes air quality by comparing concentrations of criteria pollutants to established National Ambient Air Quality Standards (NAAQS). The DOH has established ambient air quality standards similar to the NAAQS. Criteria pollutants at the national level include carbon monoxide, nitrogen dioxide, sulfur dioxide, particulate matter less than 10 microns in aerodynamic diameter, ozone, and lead. Based on ambient air monitoring data, EPA has classified the state as being in attainment of the Federal standards. In addition, pollutant concentrations within the state comply with State standards, which are more stringent than NAAQS.

Section 176(c) Conformity. This section of the Federal Clean Air Act (CAA) prohibits any Federal agency from engaging in, supporting, providing financial assistance for, licensing, permitting or approving any activity which does not conform to an applicable Federal Implementation Plan (FIP) or State Implementation Plan (SIP). Section 176(c) does not apply to the action being proposed in this EA because Section 176(c) does not apply to NAAQS attainment areas.

3.5.2 Currents and Tides

Tides in Hawai‘i are semi-diurnal with pronounced diurnal inequalities: two tidal cycles per day with unequal water level ranges. The mean tide range for Kane‘ohe Bay is 1.4 ft (0.43 m) with a diurnal range of 2.2 ft (0.67 m).

The semi-diurnal tide, the underlying large-scale oceanic current, and wind on the upper ocean layers all influence the currents around Hawai‘i; the tide is the dominant influence in most areas. The underlying oceanic flow approaches O‘ahu from the northeast and diverges between Mokapu Peninsula and Makapu‘u. Tidal currents parallel the ocean bottom contours and reverse

with the stage of the tide. The reversing tidal currents are superimposed on the oceanic flow, with flood tide currents generally moving to the east and ebb tide currents to the west. The resultant net transport of water is to the northwest. Currents associated with the semi-diurnal tide are approximately 0.5 to 1.0 knot (0.9 to 1.8 km/h), with the maximum predicted flood tide current speed of 1.2 knots (2.2 km/h) and maximum ebb tide current speed of 1.0 knot (1.9 km/h). Wind typically influences the upper 15 ft (4.6 m) of the water column during trade wind conditions.

3.5.3 Tsunamis

Since 1819, 22 severe tsunamis have occurred in the Hawaiian Islands, with runup (maximum wave height on shore) elevations ranging from 4 to 60 ft (1.2 to 18.3 m). Tsunami runup in Hawai'i during a given occurrence varies greatly with location. The elevation reached by the waves is affected by a number of factors including offshore bathymetry, coastal configuration and exposure to the generating area. The predicted 10-year wave height for the project area is 2.5 ft (0.76 m) above mean sea level, at a point 200 ft (61 m) inland of the coastline. The calculated 25-year height is 6.8 ft (2.1 m). There is no record of bore formation (tidal water that rises abruptly to form a wave as it moves inland) in this area of O'ahu, so a tsunami wave can be expected to take a form of a rapidly rising and falling tide, with a wave period of approximately 10 to 15 minutes.

3.5.4 Hurricanes

Although hurricanes occur infrequently in the immediate vicinity of Hawai'i, they do occasionally pass near the islands. Notable recent examples are Hurricane 'Iwa, which passed within 30 mi (49 km) of Kaua'i in 1982, and Hurricane 'Iniki, which passed directly over Kaua'i in 1992. Because hurricanes directly impact the Hawaiian Islands at such infrequent intervals, there is no realistic method to calculate a return period. Hurricane wave conditions at the project site are described in Section 3.2.2.

3.5.5 Geology and Soils

Mokapu Peninsula was created by volcanic activity building cones of molten rock, or lava, and steam-broken ash. Fluctuations in sea level caused by glacial activities alternately flooded and exposed the coastline, allowing thick limestone platforms and sediments to form from coral reefs that developed during lower sea levels. These platforms and sediments make up much of the relatively porous, calcareous land surface existing at Mokapu Peninsula today. The white sand of North Beach area is remnant of hard-shelled marine organisms and the erosion of coral reef structures. Heleloa sand dunes, created by the prevailing trade winds blowing beach sand inland, fringe the North Beach shore. The hillside along the onshore cable route is comprised of rock land, and a majority of the terrestrial soils in the project area consists of Molokai silty clay loam.

3.5.6 Water Quality

The waters off North Beach are classified as “A” by the DOH. Hawaii Administrative Rules (HAR) §11-54-03 state that the objective of Class A waters is to protect their use for recreational purposes and aesthetic enjoyment. Any other use shall be permitted as long as it is compatible with the protection and propagation of fish, shellfish, and wildlife, and with recreation in and on these waters.

3.5.7 Noise

Sources of ambient noise at North Beach include wind and wave noise (MCBH 2001). Wave noise is a strong contributor to ambient noise especially when large swells emanating from winter storms impinge on the beach. Intermittent passing motorboats also contribute to noise at North Beach.

Biological sounds from marine animals are another source of noise as sounds are widely used by marine mammals in their everyday survival including foraging, detecting predators, finding mates, and caring for young. Some sounds produced by humpback whales include songs, shrieks, grunts, and clicks. Dolphins emit whistles as well as barks and screams. Further information about marine mammal noises are provided in Appendix F.

Point sources of sound occur from military operations such as aircraft activities. Noise contours developed for the 1995 *Aircraft Noise Study for Marine Corps Air Facilities, Kaneohe Bay*, show that only a very narrow band of area immediately adjacent to the main runway experience noise levels above 65 decibels (dB) (MCBH 2001). Noise Zone 1 (less than 65 Ldn [day-night equivalent sound levels in units of the decibel or dB]) is an area of no impact. Noise Zone 2 (65-75 Ldn) is an area of moderate impact where some land use controls are needed. Noise Zone 3 (75 Ldn) is the most severely impacted area and requires the greatest degree of land controls. The Ldn is an average sound level generated by all aviation-related operations during an average busy-day 24-hour period, with nighttime noise levels (10:00 p.m. to 7:00 a.m.) increased by 10 dB prior to computing the 24-hour average to account for nighttime sensitivity.

3.5.8 Electromagnetic Radiation (EMR)

EMR zones are established around transmitting facilities when high-density electromagnetic power is a potential hazard to ordnance, personnel, and fuels or other volatile liquids. No EMR zones are located within the project area. Two major sources of EMR exist at MCBH Kaneohe Bay (MCBH 1999). The airport surveillance radar at the top of Pu‘u Hawai‘i Loa radiates 1.4 milliwatts (mW). The Precision Approach Radar (PAR), located in Building 5036 adjacent to the runway, radiates 80 kW at peak power. The base does not have unmitigated EMR hazards to ordnance (HERO), personnel (HERP), or fuel (HERF).

3.5.9 Ordnance Material

In the unlikely event that ordnance material is encountered that cannot be safely removed or avoided, the Navy will, as appropriate, confer with NMFS before proceeding with construction in the area of the discovered ordnance material.

The proposed project area falls outside existing Explosive Safety Quantity Distance (ESQD) arcs at MCBH Kaneohe Bay. The ESQD arcs represent hazard zones that are established by DoD for various quantities and types of explosives used by the military.

3.6 DESCRIPTION OF RELEVANT NON-AFFECTED RESOURCES – ALTERNATIVE B: PEARL HARBOR

3.6.1 Climate and Air Quality

Daytime average temperatures at Pearl Harbor range from lows of 76° F (24° C) during winter to highs of 87° F (30.5° C) in summer. Average annual humidity ranges from 58 to 80 percent. Average annual rainfall at Pearl Harbor is between 14.5 and 17.8 in (368.3 and 452.1 mm). Most of this rainfall occurs during Kona storms or rainstorms that cover the entire island.

As discussed in Section 3.4.1, areas within the state of Hawai‘i are in attainment of the NAAQS and comply with more stringent state standards.

3.6.2 Currents and Tides

The Pearl Harbor waters are influenced by a two-layer circulation system resulting from the large influx of fresh stream water to the harbor. The boundary between the two layers occurs at about the 5-ft (1.5-m) water depth in the entrance channel, but is seasonally variable. The bottom seawater layer reverses with the tide. Tides, winds, fresh water inflow, and ship-induced turbulence all affect water circulation in the harbor. Tidal currents are relatively mild, with the strongest occurring at the entrance to the harbor.

3.6.3 Tsunamis

As described in Section 3.5.3, tsunami runup in Hawai‘i during a given occurrence varies greatly with location. At the Pearl Harbor alternative site, a 100-year tsunami elevation would be 5 to 6 ft (1.5 to 1.8 m) at the harbor entrance.

3.6.4 Hurricanes

Hurricanes occur infrequently in the vicinity of the Hawaiian Islands. While the waters within Pearl Harbor are generally protected from large waves by the narrow entrance channel, the open coastal waters in the vicinity of Pearl Harbor are subject to hurricane-generated waves.

3.6.5 Geology and Soils

The ground surface of the area is the top of a fossil reef which has consolidated into limestone. This ancient reef grew when the sea level was up to 100 ft (30.5 m) higher than present. The fossil reef is highly permeable and serves as an aquifer and filter.

Below the reef, caprock consisting of a sequence of terrestrial and marine sediments extends to the top of the parent material, the Ko‘olau basalt. Overall permeability of the caprock is very low, preventing upward seepage of groundwater from the Ko‘olau basalt aquifer. The predominant soils of the West Loch area are the Mamala series or coral outcrop. Other general soil associations found in the Pearl Harbor area include the Lualualei-Fill Land-‘Ewa associations. This soil association is described as deep, nearly level to moderately sloping, well-drained soils that have a fine textured or moderately fine subsoil or underlying material, and areas of fill land on coastal plains.

3.6.6 Water Quality

Inland waters located within the Pearl Harbor entrance channel are known as the Pearl Harbor Estuary. DOH classifies these waters as Class 2, protected for recreational purposes, support and propagation of aquatic life, agricultural and industrial water supplies, shipping, and navigation. These uses are required to be compatible with the protection and propagation of fish, shellfish, and wildlife (HAR 11-54-03(b)(2)). Pearl Harbor waters and nearshore waters to 30 ft (9 m) from Keehi Lagoon (east of Honolulu International Airport) to Oneula Beach (west of NAVMAG West Loch) are listed on the State’s draft list of impaired waters under the Federal Clean Water Act Section 303(d) as “high priority” for Total Maximum Daily Load development for nutrients, turbidity, and suspended solids.⁸

DOH classifies marine waters outside the entrance channel to a depth of 600 ft (183 m) as Open Coastal Waters, designated Class A.

3.6.7 Noise

Sources of ambient noise at the Pearl Harbor site are shipping from military transit, wind and wave noise, and biological noise. The site is subject to aviation influences from the runways at both Hickam AFB and Honolulu International Airport.

3.6.8 Electromagnetic Radiation

At Pearl Harbor, potential EMR sources are individually evaluated for possible impact on personnel, fuel, ordnance, and interference. There are no major sources of EMR at the Pearl Harbor site alternative (Navy 1993).

⁸ <http://www.hawaii.gov/doh/eh/epo/303dpcdraft.pdf>

3.6.9 Ordnance Material

In the unlikely event that ordnance material is encountered that the Navy cannot safely remove or avoid, the Navy will, as appropriate, confer with NMFS before proceeding with construction in the area of the discovered ordnance material.

The project area falls just outside the ESQD arcs generated from ammunition handling wharves at NAVMAG Pearl Harbor, West Loch Branch. The risks associated with these ESQD arcs exist only when a loaded ammunition ship is at a wharf, or ammunition or explosives are staged on the wharves at NAVMAG Pearl Harbor, West Loch Branch.

3.7 RELEVANT NON-AFFECTED RESOURCES – ALTERNATIVE C: NO ACTION

With the No Action alternative, there would be no relevant non-affected resources because the WET test would not be implemented in Hawai‘i.

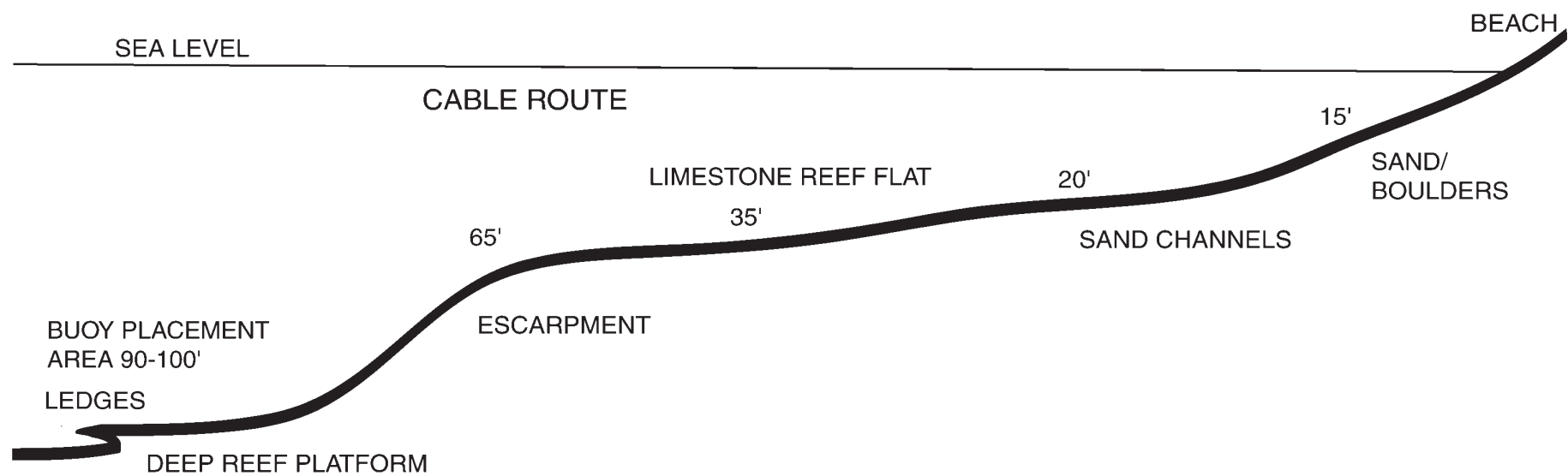

Note: Figure is not to scale horizontally or vertically.

Figure 3-1
WET BUOY/CABLE ROUTE BENTHIC ZONATION
North Beach, MCBH Kaneohe Bay

Environmental Assessment
Wave Energy Technology Project

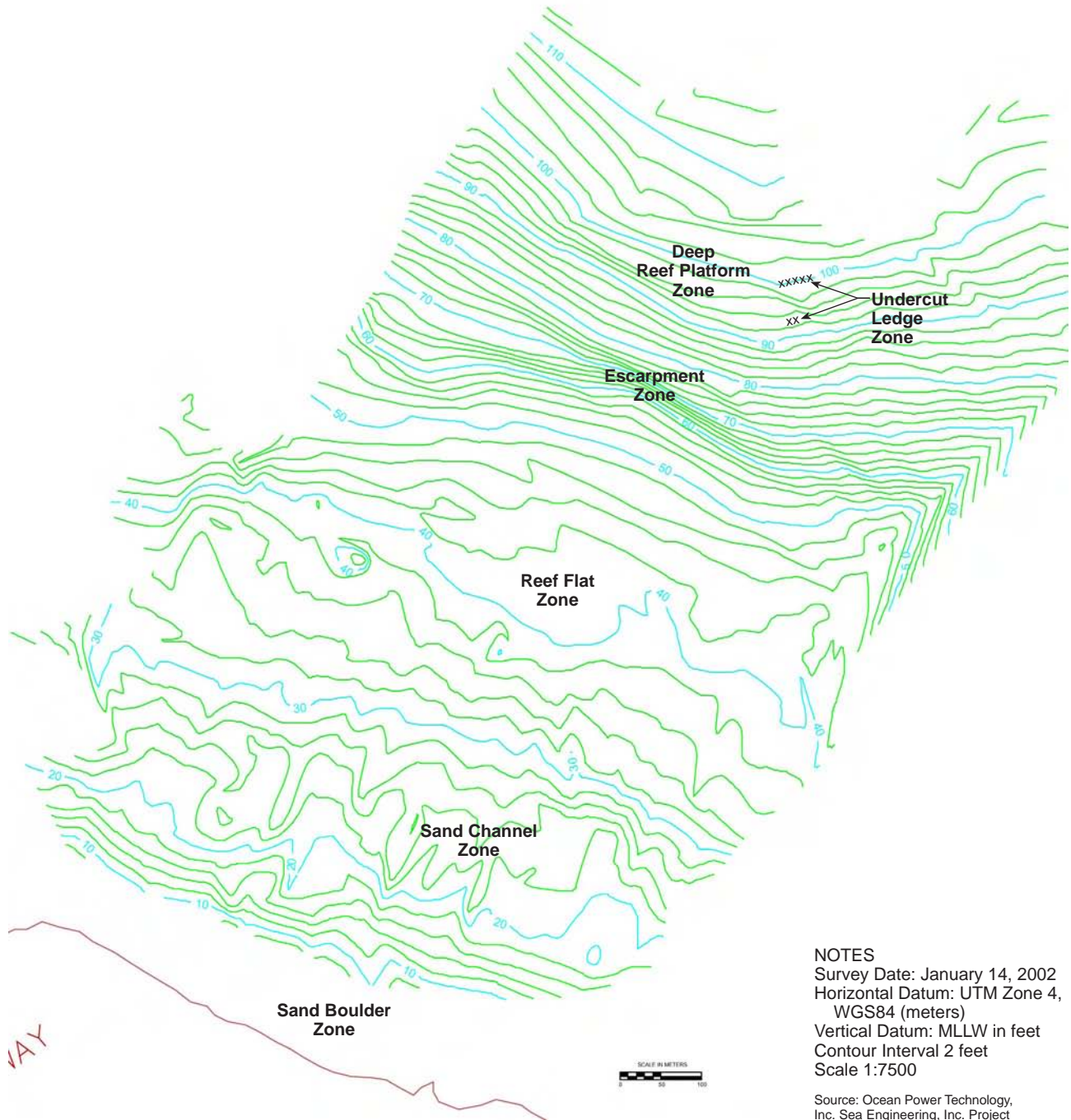

NOTES
 Survey Date: January 14, 2002
 Horizontal Datum: UTM Zone 4,
 WGS84 (meters)
 Vertical Datum: MLLW in feet
 Contour Interval 2 feet
 Scale 1:7500

Source: Ocean Power Technology,
 Inc. Sea Engineering, Inc. Project
 Number 2-01. Date 04-16-02

0 50 100 150 200
 SCALE IN METERS

0 625
 SCALE IN FEET

 NORTH

Note: Labeling of zones is approximate and not meant to depict full area of each zone.

Figure 3-2
BENTHIC ZONES
North Beach, MCBH Kaneohe Bay

Environmental Assessment
 Wave Energy Technology Project



Unobstructed view of open ocean to the north and of coastal plants such as naupaka.

Figure 3-3
VIEW TO THE NORTH
North Beach, MCBH Kaneohe Bay

Environmental Assessment
Wave Energy Technology Project



1999.82.0624/006-2.K09.09.02.4

View of North Beach looking to the northwest and Pyramid Rock.

Figure 3-5
VIEW TO THE NORTHWEST
North Beach, MCBH Kaneohe Bay

Environmental Assessment
Wave Energy Technology Project



Land cable route, Pearl Harbor Alternative.



Building 562. Equipment shelter located inside double doors to the right of the group of people visible in the photograph.

Figure 3-6
PEARL HARBOR ALTERNATIVE
LAND CABLE ROUTE

Environmental Assessment
Wave Energy Technology Project



Cable would come onshore to the left of the thick vegetation.



Cable would run along the concrete slab.

Figure 3-7
PEARL HARBOR ALTERNATIVE
CABLE LANDING SITE

Environmental Assessment
Wave Energy Technology Project

Chapter 4

Environmental Consequences

CHAPTER 4

ENVIRONMENTAL CONSEQUENCES

4.1 INTRODUCTION

Chapter 4 identifies the environmental consequences of implementing Alternative A: Proposed Action, Alternative B: Pearl Harbor, and Alternative C: No Action. It provides the scientific and analytic basis for comparing the alternatives, and presents direct, indirect, short-term, and long-term impacts on relevant resources. Direct impacts are a result of project implementation and may be short-term (temporary) or long-term. Indirect impacts are those caused by the action but occur later in time or are further removed from the action. Short-term impacts are interim changes in the local environment caused by project installation and would not extend beyond project associated activities, in this case a two- to five-year period. Long-term impacts may result in irreversible damage to resources. Cumulative impacts, discussed in Section 4.6 are those resulting from incremental impacts of the Proposed Action when added to other past, present, and future actions within an identified region of influence.

4.2 PREDICTED EFFECTS ON RELEVANT AFFECTED RESOURCES FROM ALTERNATIVE A: PROPOSED ACTION

Ten affected resources were identified in Chapter 3: shoreline physiography, oceanographic conditions, marine biological resources, terrestrial biological resources, land and marine resource use compatibility, cultural resources, infrastructure, recreation, public safety, and visual resources.

4.2.1 Predicted Effects on Shoreline Physiography

Potential impacts on shoreline conditions are dependent on the extent to which features such as vegetation or sand deposition patterns could be damaged or altered by the proposed project during installation and operation.

Impacts to the shoreline from the proposed installation would be minimal. A backhoe loader and hydraulic crane would be used to pull the undersea transmission cable ashore and assist with its placement on land. Heavy equipment activities would be specified to minimize disturbance to the shoreline and would be restricted to the end of the runway or the dirt roadway near the runway.

The prefabricated, concrete utility vault would be lifted into place with a crane and placed onto a gravel bed. Use of a gravel bed would promote drainage and ground water infiltration.

The presence of the WEC system would not alter currents or wave directions (Section 4.2.2), so shoreline physiography would not be affected. The WEC buoys would have only a very localized effect on currents and the affected area would not extend more than a few buoy diameters. There would be no effects on shoreline erosion or sand deposition patterns. Upon completion of the system test, the land based cable and equipment would be removed.

4.2.2 Predicted Effects on Oceanographic Conditions

Potential impacts on oceanographic conditions are dependent on the extent or degree to which the WEC buoys affect wave scattering or reflection and energy absorption.

The WEC buoys would not impact oceanographic conditions. This determination is based on analyses of (1) wave height reduction due to wave scattering and (2) wave height reduction due to energy absorption. Using a numerical solution to evaluate wave scattering caused by a wave passing through an infinite grating of circular cylinders, results indicate that the effects of six WEC buoys on wave transmission and reflection would be negligible. This is due to the relatively large design spacing between the buoy cylinders, 169 ft (51.5 m), as compared to the buoy diameter of 15 ft (4.5 m). Potential effects on wave heights due to energy absorption were analyzed by running a wave refraction-diffraction model. Results estimated that wave heights near the shoreline would be reduced by 0.5 percent for a wave period of 9 s, and less than 0.3 percent for a period of 15 s. The impact of six WEC buoys on a wave field would be minimal and would not be noticeable or quantifiable given the randomness of the wave action.

Appendix J provides details of the inputs, methodology, and findings of the analyses used to evaluate the predicted effects of the buoys on oceanographic conditions.

4.2.3 Predicted Effects on Marine Biological Resources

Potential impacts on marine biological resources are dependent on the extent or degree to which installation and operation of the WEC system would: (1) impact any marine mammal species or species listed as threatened or endangered under Federal or State law, (2) affect sensitive habitat or habitat critical to the continued existence of any threatened or endangered species, (3) affect HAPC, or (4) change the distribution or reduce the population of other marine species.

No significant impacts would occur to marine biological resources from installation and operation of the WEC system. The USFWS and NMFS concur with the Navy that the Proposed Action is not likely to adversely affect threatened or endangered species under their jurisdictions. The Proposed Action is not within an HAPC.

Protocols for avoiding impacts to listed protected species during installation of the buoys and undersea cable at the active site would be specified in the construction contractor's Best Management Practices (BMPs). Such protocols would address the protection of mammals protected under the MMPA, including the endangered Hawaiian monk seal, the endangered humpback whale, and various species of dolphin, as identified in Table 7-1 of Appendix F.

Protection under the MMPA would be provided in accordance with Navy policy documented in the Chief of Naval Operations Instruction (OPNAVINST 5090.1B). Considering the proposed project activities, evaluation of potential impacts (presented herein), and the protections afforded by law and Navy policy, the taking of marine mammals under the MMPA is unlikely during the installation and operation of the WEC system.

Predicted effects on marine biological resources are discussed relative to undersea cable installation, buoy installation, operation, and removal of the WEC system in the following sections.

4.2.3.1 Installation of the Undersea Cable

Potential impacts on marine species from installation of the undersea cable include: (1) noise impacts due to the installation of rock bolts, (2) damage to corals within the narrow corridor of the undersea cable, and (3) entanglement of marine mammals with the cable.

The noise produced by drilling holes for the rock bolts would be localized, intermittent, and of short duration. Humpback whales, dolphins, and green sea turtles would be able to sense the sound produced by the drills but neither the amplitude nor the frequencies of noise produced would be sufficient to constitute an impact on these animals. It is unlikely that the noise would adversely impact marine species by disrupting feeding or other behaviors. Turtles and fish, in particular, may be attracted to the activity, possibly by the bottom biota stirred up by the drilling. Appendix F provides further discussion on this subject.

Installation of the cable would minimize interactions with biota by avoiding areas of rich biological diversity and high percentages of coral coverage. The selected cable route follows cracks and sand channels, most of which are filled with a layer of sand, precluding settlement of biota (Appendix E).

While unlikely, there is potential for entanglement of marine mammals and sea turtles with the undersea cable. Historically, problems with entanglement were due primarily to the lack of technology available to precisely place and secure a cable or control the amount of tension. This resulted in spanning or bridging of the cable, and loops developing over time. In contrast to these early systems, the WEC undersea cable would have the following characteristics:

- Installation would occur in shallow water (i.e., depths to approximately 100 ft [30.5 m]).
- Installation would occur with adequate tension to allow the cable to contour to the seafloor without suspensions or forming loops. Divers would inspect the cable route once it is placed.
- The length of the cable is relatively short compared to trans-oceanic undersea cables, about 3,900 ft (1,190 m).

No significant impacts to marine species would occur with installation of the undersea cable. The noise produced from drilling is unlikely to adversely impact humpback whales, dolphins, or green sea turtles. The limited duration of the cable installation and placement of the cable flat on the seafloor would minimize the risk of listed species encountering or becoming entangled in the

cable. There would be no risk of entanglement once the cable is rock-bolted to the seafloor. Mooring lines and anchor chains for the four mooring clumps would be pulled taut during installation, minimizing risks of entanglement.

4.2.3.2 Installation of the Buoy

No significant impacts to marine species would occur with installation of the buoys. In the area of the deep reef platform selected for the buoy array (the 95- to 104-ft [29.0- to 31.7-m] depth), the composition of the bottom is very homogeneous, consisting of limestone covered with a thin veneer of algal turf. The placement of the buoy anchors on the seafloor would impact the biota directly beneath each anchor, an area approximately 30 by 30 ft (9.1 by 9.1 m). The total area of the seafloor ultimately covered by six anchors would be 5,400 sq f. (497 sq m). Holes would be drilled to rock-bolt the anchors to the seafloor. Buoy installation and anchoring would cause only minor, localized turbidity as the seafloor at the site is relatively devoid of sand or sediment. The heavy ballast of the anchors and the installation of rock bolts on the flange frames would restrict movement of the anchors and scouring of the seafloor. Impacts on marine biota would be minimized by avoiding areas containing live corals.

The noise produced by drilling holes for the rock bolts would be localized, intermittent, and of short duration, as discussed in Section 4.2.3.1. Pelagic fish such as wahoo and skipjack tuna are highly mobile and, therefore, would not be affected during installation of the buoys and associated hardware. Bottom-dwelling fish such as goatfish are not abundant in the project site, and those that may be present would be displaced to nearby areas.

4.2.3.3 Operation of the WEC System

The potential for adverse impacts on marine biological resources during WEC system operations is minimal and not significant. However, as part of the Navy's BMPs, a biological monitoring plan for fish and benthic organisms will be developed. Analyses conducted for the project indicate that there could be short-term direct impacts resulting from entrapment, exposure to EMR, and electrical leakage. No long-term direct or indirect effects are anticipated. Potential impacts due to heat and noise exposure were also analyzed and found to be negligible. Findings are summarized herein.

Entrapment. The potential for entrapment of marine species such as sea turtles within the WEC buoy structure is minimal (refer to Figure 2-5, Section 2.4.1.2, and Appendix F). The top of the buoy is closed, and the bottom is open, allowing ingress and egress through only one end. Although the possibility exists for an animal to enter and become disoriented, the size of the opening in the bottom of the WEC buoy provides a ready egress path. There are no entanglement or snagging obstructions within the interior of the structure to prevent egress. No horizontal flat surfaces exist within the buoy to provide resting habitat for marine species such as turtles.

EMR. In the natural environment, marine organisms are exposed to, and influenced by, electric and magnetic (EM) fields. Species with developed sensory receptors that can detect

electric or magnetic fields can use this information for various behaviors. The sensing of electric fields by organisms is termed electroreception. The sensing of magnetic fields is magnetoreception. Exposure to EM fields has the potential to affect marine organisms in a variety of ways. The analysis conducted for the WET test considered only the potential for behavioral effects (Appendix F).

Power cables generate both electric and magnetic fields. The flow of seawater across the electric field of a power cable generates a weak magnetic field. Potential electric and magnetic fields surrounding the WEC undersea cable have been calculated for a range of electrical currents through the cable.

Based on the anticipated current passing through the WEC cable, the electric field strength at the surface of the cable would range from approximately 1.5 to a maximum of 10.5 millivolts per meter (mV/m) and would decrease exponentially with distance from the cable. The magnetic field strength at the surface of the cable would range from approximately 0.1 amperes (amps [A]) per meter (A/m) to a maximum of 0.8 A/m and would decrease exponentially with distance from the cable.

Organisms sensitive to magnetic fields may exhibit one of three behaviors: (1) detection and no effect, (2) detection and confusion or avoidance, or (3) attraction. These different behavioral patterns are discussed below.

- *Detection and no effect.* The first scenario is highly probable since the cable would be carrying alternating current rather than polarized direct current. The organism would detect the magnetic field but not exhibit any response.
- *Detection and confusion or avoidance.* In the second scenario, the organism may disrupt its current behavior while it “reanalyzes” the situation. The expected outcome is for the organism to assess the information from other sensory cues, ignore the anomalous magnetic perception, and continue its previous behavior. Avoidance would be the worst-case situation because it would mean that organisms were intimidated or uncomfortable within the magnetic field.

The magnetic field resulting from the proposed WEC cable may affect the magnetoreception sensors of fish, including sharks, rays, and skates, in the vicinity of the cable and cause these animals to be temporarily confused. The impact on sharks would be minimal based on research studies with other undersea cables. Bottom-dwelling organisms would be the most likely to show avoidance behavior, while pelagic species (fish that spend most of their life swimming in the open area of the ocean) could readily swim over the magnetic field.

Studies have demonstrated that sea turtles, whales, dolphins, porpoises, sharks, and rays are capable of following geomagnetic contours along the ocean floor, indicating a sensitivity to magnetic sources. Since the cable occupies a small area of the seafloor, the impact of avoidance behavior that could be potentially exhibited by marine organisms, in response to the presence of the WEC cable, would be minimal.

The cable does not cross any known critical migratory paths for threatened or endangered species.

- *Attraction.* Behavioral attraction of marine mammals to magnetic fields has not been recorded (Appendix F). The effects of attraction on marine mammals or other marine organisms are not possible to predict due to the lack of knowledge about factors such as the species attracted, number attracted, species behavior in the vicinity of the cable, reactions of other species in response to an aggregation, and numerous other factors.

Based on the available data as described in Chapter 4 and cited in Appendix F, impacts of electric and magnetic fields on marine organisms can be expected to range from no impact to avoidance of the vicinity of the WEC cable. Organisms sensitive to electric or magnetic fields may detect emissions near the WEC cable; however, the effects would be temporary. Since the cable occupies a small area of the seafloor, the impact of avoidance behavior would be minimal. The cable route would not occupy any unique feeding, breeding, birthing, or egg-laying areas. The analysis provided in Appendix F found no evidence in the literature of either short- or long-term effects of electric or magnetic fields from cables similar to the WEC cable on marine organisms, other than the possible behaviors described. Although there have been numerous inconclusive studies of the effects of electromagnetic fields on animals in air, no similar studies have been found of the effects of EMR on marine animals in seawater.

Electrical Leakage. During operation, the WEC system could possibly experience an electrical fault or short due to damage to the cable. In the event of an electrical fault, there is a short period of time during which the electrical current generated by the WEC system would leak to seawater. However, the computer-controlled electrical fault detection and circuit interruption system would shunt the electrical current to the load resistors within 6 to 20 milliseconds (ms), limiting the duration of the electrical field. If the fault persists, an electric field would develop in the vicinity of the fault. The voltage gradient would depend on the fault current and the distance from the fault.

A series of Navy studies on the effects of electrical fields found that fault durations of less than 20 ms and fault currents of less than 5 mV had only transient effects on marine life or divers (Appendix F). For divers, effects were generally described as a mild discomfort. The studies found no short or long-term effects from transient fields less than 20 ms and 5 mV; the only effects were transient. No other literature was found directly describing the effects of this type of highly transient electrical field on marine life. It is likely that electroreceptive species would simply detect the field and be diverted away from the vicinity of the fault during the brief period while the ground fault system actuates. With the WEC system, this period of exposure would be 20 ms or less. To prevent electrical faults or shorts from occurring, the WEC undersea cable would be armored with steel wires and an external jacket that make it highly resistant to damage. In addition, protection from leakage has been designed into the system. A computer-controlled fault detection and interruption system would divert the electric current from the cable and store it in load resistors in the event of a fault.

Heat. The effects of heating on marine organisms can be expected to reflect the Van't Hoff-Arrhenius relationship between temperature and metabolism, that a 50° F (10° C) increase in temperature would approximately double the metabolism of the organism, within the limits of ambient temperatures. Small temperature changes within ambient conditions have correspondingly small effects on metabolism. The average ambient temperature of the seawater surrounding the WEC undersea cable is 78.8° F (25.6° C), with a range of 75.9 to 80.4° F (24.4 to 26.9°C). The water in the relatively shallow depth at the site is in constant motion due to the wave action and currents.

The energy loss from resistance in an undersea cable results in the generation of heat and dissipation of this heat to the surrounding environment. The resistive losses in the WEC cable are calculated to range from 20 mW per foot (0.9 m) of cable for a single buoy generating 20 kW of power, to approximately 1.4 W per foot of cable (0.9 m) in the case of up to six buoys generating 250 kW. Based on the calculated resistive losses, the temperature rise in the cable is estimated to range from less than 0.018° F (0.01° C) for a single buoy to less than 0.025° F (0.023° C) for six buoys.

Heat losses from the WEC undersea transmission cable would have negligible impacts on seawater temperature in the vicinity of the cable, due to immediate dissipation by the natural flow of seawater. The large volume of seawater around the cable would keep temperature differences less than the natural differences due to solar heating, upwelling, and current-induced mixing. Although the WEC cable is in contact with the seafloor, the thermal resistance of the sediments or other seafloor material is substantially higher than that of the seawater. Hence, the heat transferred directly into the seabed materials would be negligible.

Heat released from the equipment canister, load resistors, and hydraulic fluid heat exchanger into the surrounding water is anticipated to be similar in nature to heat released from the undersea cable. The resulting temperature increase for a single buoy would be approximately 0.07° F (0.02° C). For six buoys, the resulting temperature rise would be 0.42° F (0.12° C), and in the constantly moving water at the project site, this change would be negligible.

Noise. There are no field data available on the acoustic output of the WEC system during operation. The WEC system is expected to produce a continuous acoustic output with an amplitude approximately similar to that of light to normal ship traffic, with a spectral content shifted to frequencies somewhat higher than shipping (Appendix F). Humpback whales, dolphins, and green sea turtles can sense acoustic energy of this amplitude and frequency content. However, no adverse impact on these species are anticipated because (1) there is no evidence in the literature that the amplitude and frequency of the noise expected to be produced by the WET system during operation will constitute an impact on these species, and (2) no other continuous sounds with a similar frequency, which could contribute to additive effects, were identified in the area. The taking of marine mammals, as defined under the MMPA, is unlikely. Refer to Appendix F for a more detailed discussion.

Potentially beneficial direct impacts on marine biological resources associated with the presence of the WEC system could occur. The WEC cable, anchor, and mooring block and chain could promote settlement of benthic organisms such as corals, which is validated by the observation of

the high colonization rate of a discarded track from an amphibious vehicle in the reef flat zone.¹ As a result of coral growth on the cable and buoy anchor, a new fish habitat may be created. In addition, the buoys, anchors, and associated structures are anticipated to act as a Fish Aggregating Device (FAD).

There would be no indirect impacts to marine species such as the triggering of algal blooms or other negative shifts in biotic composition, particularly by the introduction of alien species. It is likely that alien species presently considered a nuisance within Kane‘ohe Bay are restricted to the particular oceanographic conditions and habitat that are unique to the Inner Bay. As the oceanographic climate at the wave-exposed project site varies greatly from the Inner Bay, the spread of alien algal species is unlikely (refer to Appendix H).

4.2.3.4 Removal of the WEC System

At the end of the test period, the Navy in conjunction with NMFS, USFWS, and the State DLNR, would determine whether equipment installed on the seafloor (i.e., the cable, buoy anchor system from the universal joint down, mooring clump base and anchoring system) should be removed or left in place. This material would not be considered “fill” under Section 10 of the Rivers and Harbors Act. Equipment such as the buoys and equipment canisters would be removed at the end of the test period.

4.2.4 Predicted Effects on Terrestrial Biological Resources

Potential impacts on terrestrial biological resources are dependent on the extent or degree to which the installation and operation of the WEC system would: (1) impact any species listed as threatened or endangered under Federal or State law, (2) affect sensitive habitat or habitat critical to the continued existence of any threatened or endangered species, or (3) change the distribution or reduce the population of other flora and fauna species.

Impacts on terrestrial biota would be minimal and not significant. There are no Federally or State-listed species found along the route proposed for the land cable. Wedge-tailed shearwater burrows exist in the vicinity of the proposed cable route; however, these sites will be avoided by placing the land cable, utility vault, and equipment shelter in previously disturbed areas and in existing facilities such as Battery French. The proposed project would not adversely affect native flora along the proposed land cable route.

4.2.5 Predicted Land and Marine Resource Use Compatibility Effects

Potential impacts on land and marine resource use are dependent on the extent or degree to which the proposed project would interfere with mission operations and/or compromise the integrity of land and marine resource uses in the area.

¹ Furthermore, the presence of the metal tank track has not resulted in the growth of any biota on the surrounding reef that could be construed as a negative feature, such as blue-green algae (see Appendix H).

No significant impacts to land and marine resource use are expected with implementation of the WET test. Conflicts in marine resource use (e.g., conflicts with recreational activities such as fishing, boating, and diving) are anticipated from installation of the buoy array 1,200 yds (1,097 m) offshore, well outside the 500-yd (457-m) buffer zone. The proposed buoy array site is currently open to the public for fishing, boating, and diving. Although the area is subject to access limitations, at the present time public access is unrestricted. Therefore, no mitigation measures are proposed. To ensure public safety (refer to section 4.2.9) warning signs would be installed on each buoy to warn boaters and other recreational users of the area about the submerged obstruction and high voltage electric cable.

The WET test would not interfere with mission operations at MCBH Kaneohe Bay.

4.2.6 Predicted Effects on Cultural Resources

Potential impacts on cultural resources include the degree to which an alternative results in a change in the characteristics that qualify a historic property for listing in the NRHP. The Proposed Action will occur partially within the boundaries of the Mokapu Burial Area and will involve the modification and use of a historic structure, Battery French. The Proposed Action is not expected to alter the characteristics qualifying these properties for inclusion in the NRHP.

Adverse impacts on the Mokapu Burial Site would be avoided. Previous studies have identified certain loci within the boundaries of the MBA that are known or likely to contain human remains or archaeological deposits. Activities associated with the Proposed Action would occur outside these loci.

If human remains or archaeological deposits were to be found in the project area, it is expected that they would be fairly deep below the ground surface. Investigations conducted for this project found that this area was covered with at least two feet of fill. Activities associated with the project would cause minimal ground disturbance and would be unlikely to encounter such deposits. Heavy equipment would access the project area using the taxiway and an existing dirt roadway in an area capped by fill. Movement of the equipment would be limited to placing the utility vault with a crane and staging the equipment near the ingress of the undersea cable to the shore for emergency support.

Should human remains or archaeological deposits be unexpectedly encountered, the appropriate provisions of NAGPRA and the NRHP will be followed.

Impacts on Battery French would be confined to the interior of the structure, which has been previously modified. The exterior of the structure, including the turret foundations, and its settings would not be altered.

In accordance with the regulations implementing Section 106 of the NHPA, 36 CFR Part 800, the Hawaii SHPO was consulted on the Proposed Action and the agency concurred with the Navy's determination of "no historic properties affected" (see Appendix A-5). Notification of this finding was also provided to Native Hawaiian organizations and individuals that have

previously expressed an interest in actions involving the Mokapu Burial Area. One organization, the Office of Hawaiian Affairs, and two of the consulted individuals provided comments on the Proposed Action. Their views are provided in Appendix A-5.

4.2.7 Predicted Effects on Infrastructure

Potential impacts on the electrical utility system include the extent or degree to which the proposed project would affect the quality of the electrical utility system.

No significant impacts are expected to occur on infrastructure. Modifications to Battery French would be minimal and limited to the interior (Section 2.4.1.2). Connection to the MCBH Kaneohe Bay power grid would supplement the existing base power. Moreover, the MCBH Kaneohe Bay electrical system would not be adversely affected by the WET project. Capacitors, the main inverter, and grid-side switchgear would protect the MCBH Kaneohe Bay electrical system. Power from the individual wave energy converters (up to six) feed a central DC bus and capacitor bank. The capacitors would absorb power surges from one or more of the wave energy converters. Power from the DC bus would then be transferred to the MCBH Kaneohe Bay power grid via a surge-protected DC/AC inverter.

4.2.8 Predicted Effects on Recreation

Potential impacts on recreation are dependent on the extent or degree to which the proposed project would interfere with the use and enjoyment of facilities and resources within the study area.

The undersea cable would cross the beach and connect to the utility vault within the 300-ft (91.4-m) restricted zone adjacent to the main runway. This zone is controlled by flight operations and is off limits to all recreational users. Information on regulations is made available to all residents, employees, and the general public; enforcement is provided by lifeguards, security personnel from Waterfront Operations, and base security personnel.

Recreation in the vicinity of the buoy array would be impacted for the two- to five-year project duration, however, the impact would not be significant. At present, there are no plans to restrict public access to the buoy array site. Warning signs would be installed on each buoy to warn boaters and recreational users of the area about the submerged obstruction and high voltage electric cable. Spear fishers, trollers, bottom-fishers, and boaters would have to detour around the buoys in transit to other sites. If public access to the WEC buoy array is not restricted, bottom-fishing, trolling, and SCUBA diving may increase, as the buoys would act as a FAD.

4.2.9 Predicted Effects on Public Safety

Potential impacts on public safety are determined by the extent or degree to which the project would interfere with enforcement of existing public safety regulations or cause harm to the public.

The buoy array would lie within a relatively heavily traveled corridor. Marine recreation user interviews (Appendix I) reveal that many local users of the area believe that potential adverse impacts would occur, regardless of safety precautions. Concerns on safety include recreational divers exploring the buoy system components and the possibility of a buoy breaking loose and creating a hazard to navigation. Another concern is the heightened danger of transiting watercraft colliding with the buoys, compounded by the possibility that the buoy would draw boaters and fishers to the area by its ability to attract and aggregate fish.

In response to the concerns identified above, potential hazards to public safety would need to be mitigated by installing appropriate markings on the buoy, implementing a response plan for reacting to system failures, and establishing communication procedures to promote public awareness of the WET system. Each buoy will be equipped with USCG-approved safety lights and standard USCG signage, such as ‘Government Property, Submerged Obstruction.’ An emergency response plan will be developed for mooring break and electrical fault alerts and for responding to other emergencies. In addition to filing a USCG Notice to Mariners to advise boaters on the location and dangers of venturing too close to the buoy array, press releases and community briefings are planned by the Navy to promote project awareness. Removal of the WET system at the end of the five-year test period would eliminate the aforementioned public safety concerns.

4.2.10 Predicted Effects on Visual Resources

Potential impacts on visual resources include the extent or degree to which the project would: (1) degrade the quality of an identified visual resource, including but not limited to a unique topographic feature, undisturbed native vegetation, or surface waters, or (2) obstruct public views of a scenic vista.

Impacts on scenic views would be minimal and temporary. Navigational aids on the buoys would extend approximately 30 ft (9 m) above sea level. At a distance of approximately 3,900 ft (1,220 m) from shore, the impact of the navigational aids would be minimal during both daytime and nighttime hours. At night, safety lights on the navigational aids would be visible in the distance.

4.3 PREDICTED EFFECTS ON RELEVANT AFFECTED RESOURCES FROM ALTERNATIVE B: PEARL HARBOR

4.3.1 Predicted Effects on Shoreline Physiography

Potential impacts on shoreline conditions are dependent on the extent or degree to which features such as vegetation or sand deposition patterns could be damaged or altered.

Installing the land cable, utility vault, and equipment shelter in previously disturbed areas (e.g., along the paved parking lot border) and in existing facilities (Building 562) would minimize impacts. The WEC system during operation would not alter currents or wave directions. Hence, there would be no effect on shoreline physiography during operation. Upon completion of the system tests, the land based cable and equipment would be removed.

4.3.2 Predicted Effects on Oceanographic Conditions

Potential impacts on oceanographic conditions are dependent on the extent or degree to which the WEC buoys affect wave scattering or reflection and energy absorption.

There would be no impacts on oceanographic conditions for the same reasons presented in Section 4.2.2.

4.3.3 Predicted Effects on Marine Biological Resources

Potential impacts on marine biological resources are dependent on the extent or degree to which installation and operation of the WEC system would: (1) impact any marine mammal species or species listed as threatened or endangered under Federal or State law, (2) affect sensitive habitat or habitat critical to the continued existence of any threatened or endangered, (3) affect HAPC, or (4) change the distribution or reduce the population of other marine species.

Predicted effects on marine biological resources are discussed relative to undersea cable installation, buoy installation, operation, and removal of the WEC system.

No significant impacts would occur to marine biological resources from installation and operation of the WEC system. The Pearl Harbor site is not within an HAPC. Based on recommendations for aquatic resources management in the Pearl Harbor INRMP, installation and operation of the WEC system at this alternative site would not impact aquatic resources management objectives. If the Pearl Harbor site is selected, the Navy would initiate an informal Section 7 ESA consultation for that site.

The Pearl Harbor entrance channel is designated as an aquatic resources management area. This designation directs the Navy to protect, conserve and manage aquatic resources as vital elements

of the natural resources program. In addition, the Navy is to obtain and maintain baseline information on aquatic resources and fisheries at Pearl Harbor in order to facilitate effective resource management, monitor and track changes in the quality of the marine environment over time, and protect threatened and endangered marine species that may occasionally occur in the harbor waters.

Protocols for avoiding impacts to listed protected species during installation of the buoys and undersea cable at the active site would be specified in the construction contractor's BMPs. Such protocols would address the protection of mammals protected under the MMPA, including the endangered Hawaiian monk seal, the endangered humpback whale, and various species of dolphin, as identified in Table 7-1 of Appendix F. Protection under the MMPA would be provided in accordance with Navy policy documented in the Chief of Naval Operations Instruction (OPNAVINST 5090.1B). Considering the proposed project activities, evaluation of potential impacts (presented herein), and the protections afforded by law and Navy policy, the taking of marine mammals under the MMPA is unlikely during the installation and operation of the WEC system.

4.3.3.1 Installation of the Undersea Cable

Adverse impacts on marine species from installation of the undersea cable could include: (1) noise impacts due to the installation of rock bolts, (2) damage to corals within the narrow corridor of the undersea cable, and (3) entanglement of marine mammals with the cable. The potential effects of noise and entanglement on marine organisms are similar to those presented in Section 4.2.3.1.

Installation of the WEC system would minimize interactions with biota by avoiding areas of rich biological diversity and high percentages of coral coverage.

The limited duration of the cable installation and use of modern cable laying techniques would minimize the risk of Hawaiian monk seals and green sea turtles becoming entangled in the cable. There would be no risks of entanglement once the cable is secured to the junction of the channel slope and bottom.

4.3.3.2 Installation of the Buoy

Impacts on marine biological resources during installation of the buoy array would be minimal, similar to those described in Section 4.2.3.2. In the area of the sand-rubble zone selected for the buoy array, the composition of the bottom is very homogeneous, consisting of loose sand deposits with occasional rubble outcrops. As the seafloor in this area is relatively devoid of living coral or algae, initial placement of the buoy anchor on the seafloor would have minimal impact on biota. Fish may be temporarily disturbed but would likely swim away from the area. For these reasons no significant impacts would occur to marine biological resources from installation of the WEC system.

4.3.3.3 Operation of the WEC System

The potential for adverse impacts on marine biological resources during WEC system operations is minimal and not significant. Impacts due to entrapment within the buoy and exposure to EMR, electrical leakage, heat, and noise are summarized below. For a more in-depth analysis, refer to Section 4.2.3.3 and Appendix F.

Entrapment. There is minimal potential for entrapment of marine animals such as turtles within the WEC buoy structure. The interior of the buoy is free of obstructions, sharp edges, or corners, and the open bottom of the buoy provides a ready egress path. No horizontal flat surfaces exist within the structure to provide resting habitat for marine species such as turtles.

EMR. Based on the available data as described in Chapter 4 and cited in Appendix F, impacts of electric and magnetic fields on marine organisms can be expected to range from no impact to avoidance of the vicinity of the WEC cable. The analysis provided in Appendix F found no evidence in the literature of either short- or long-term effects of electric or magnetic fields from cables similar to the WEC cable on marine organisms other than the possible behaviors described in Section 4.2.3.3.

Electrical Leakage. There is potential for a very short-term electrical current leakage within the WEC system. It is likely that electroreceptive species would detect the field and be diverted away from the vicinity of the fault during the brief period while the ground fault system actuates. Studies have found that no short- or long-term effects in divers from transient fields less than 20 ms and 5 mV; the only effect observed were transient in nature (mild discomfort) (Appendix F).

Heat. Heat losses from the WEC undersea transmission cable would have negligible impacts on seawater temperature and seabed materials in the vicinity of the cable and hence, there would be no effects on marine biota. There would be no effects from heat on marine species.

Noise. There are no field data available on the acoustic output of the WEC system during operation. As explained in section 4.2.3.3, there is no evidence that the amplitude and frequency of the noise produced by the WEC system operation would impact humpback whales, dolphins, or green sea turtles (Appendix F).

Potentially beneficial direct impacts on marine biological resources would be associated with the presence of the WEC system, and creation of fish habitat given coral growth on the cable, anchor, mooring clump and anchor chain.

There would be no indirect impacts to marine species such as the triggering of algal blooms or other negative shifts in biotic composition, particularly by the introduction of alien species.

4.3.3.4 Removal of the WEC System

At the end of the test period, the Navy in conjunction with NMFS, USFWS, and DLNR would determine whether equipment installed on the seafloor (i.e., the cable, buoy anchor system from

the universal joint down, mooring clump base and anchoring system) should be removed or left in place. This material would not be considered “fill” under Section 10 of the Rivers and Harbors Act. Other equipment such as the buoys and equipment canisters would be removed at the end of the test period.

4.3.4 Predicted Effects on Terrestrial Biological Resources

Potential impacts on terrestrial biological resources are dependent on the extent or degree to which the installation and operation of the WEC system would: (1) impact any species listed as threatened or endangered under Federal or State law, (2) affect sensitive habitat or habitat critical to the continued existence of any endangered or threatened species, or (3) change the distribution or reduce the population of other flora and fauna species.

No species listed under the ESA as threatened or endangered were found along the proposed land cable route. Two State-listed birds, the threatened white tern and endangered short-eared owl, are occasionally found in the Pearl Harbor vicinity; however, these species have not been identified in the area of the proposed land cable route. The land cable route and proposed site for the utility vault would be sited on previously disturbed areas along the paved parking lot border and the lawn of Building 562. Equipment would be sheltered in Building 562. Use of disturbed areas and existing facilities would minimize potential effects on terrestrial biota. The proposed project would not create changes in local populations of flora and fauna at the Pearl Harbor site.

4.3.5 Predicted Land and Marine Resource Use Compatibility Effects

Potential impacts on land and marine resource uses are dependent on the extent or degree to which the proposed project would interfere with mission operations and/or compromise the integrity of land and marine resource uses in the area.

No significant impacts to land and marine resource uses are anticipated from the WET project. The entire WEC system would be within a restricted area minimizing security risks, which would help to maintain system survivability over the two- to five-year test period. The proposed project would not interfere with mission operations at NAVMAG Pearl Harbor, West Loch Branch.

4.3.6 Predicted Effects on Cultural Resources

Potential impacts on cultural resources include the extent or degree to which an alternative results in a change in the characteristics that qualify an historic property for listing in the NRHP.

Although the Proposed Action at this alternative site would occur within the boundaries of the Pearl Harbor National Historic Landmark, no impacts on the Landmark are anticipated. The Proposed Action would not cause effects on any listed, contributing, or eligible historic properties within the landmark. The land segment of the project is in an area designated in the

Pearl Harbor Naval Complex Integrated Cultural Resources Management Plan as having no or low potential for archaeological deposits (Commander Navy Region Hawaii 2001).

4.3.7 Predicted Effects on Infrastructure

Potential impacts on the electrical utility system include the extent or degree to which the proposed project would affect the quality of the electrical utility system.

The wave energy converters would be connected to the electrical grid system. Power from the energy converters would be routed through a central DC bus and capacitor bank that could absorb power surges. The power from the DC bus would then be transferred to the Puuloa/Iroquois Housing area power grid via a surge-protected DC/AC inverter. The addition of isolation transformers may also be considered during the system design if necessary to provide additional protection to the power grid.

4.3.8 Predicted Effects on Recreation

Potential impacts on recreation are dependent on the extent or degree to which the proposed project would interfere with the use and enjoyment of facilities and resources within the study area.

Impacts to recreation within the Pearl Harbor entrance channel would be minimal since the area is largely restricted to boats owned and operated by military or DoD personnel. Direct impacts to recreation would occur at the location of the proposed buoy array, but public access is already limited in this area for fishing, boating, diving and other recreational activities. Impacts to recreation from the buoy array would be similar to those described in Section 4.2.8.

4.3.9 Predicted Effects on Public Safety

Potential impacts on public safety are dependent on the extent or degree to which the project would interfere with enforcement of existing public safety regulations or potentially cause harm to the public.

The buoy array would lie within a relatively heavily traveled corridor. Potential short-term impacts on public safety include increased use of the area by boaters and fishers if the buoys act as FADs, boat collisions with the buoys, concerns due to divers choosing to explore the buoys, and buoys breaking loose and becoming a hazard to navigation. Promoting public awareness of the project could mitigate some of these impacts, which could lessen over the test period as awareness increases. Removal of the system at the end of the test period would eliminate these potential impacts. Impacts to public safety from the system and proposed mitigation would be similar to that described in Section 4.2.9.

4.3.10 Predicted Effects on Visual Resources

Potential impacts on visual resources include the extent or degree to which the project would: (1) degrade the quality of an identified visual resource, including but not limited to, a unique topographic feature, undisturbed native vegetation, or surface waters, or (2) obstruct public views of a scenic vista.

Impacts on views would be minimal and temporary. Navigational aids from the buoys would extend 30 ft (9 m) above sea level. The impact would be minimal during both daytime and nighttime hours. At night, safety lights on the navigational aids would be visible in the distance.

4.4 PREDICTED EFFECTS ON RELEVANT AFFECTED RESOURCES FROM ALTERNATIVE C: NO ACTION

As the WET test would not be implemented in Hawai‘i, there would be no impacts on affected resources.

4.5 ENERGY REQUIREMENTS AND CONSERVATION POTENTIAL

Energy requirements for Alternative A: Proposed Action and Alternative B: Pearl Harbor include fuel for installation and maintenance vehicles and equipment. The proposed WET test may contribute energy to the installation electric grid, providing a means of conserving or reducing use of fossil fuels.

4.6 CUMULATIVE IMPACTS

Cumulative impacts are effects on the environment that result from the incremental impact of the action when added to other past, present, and reasonably foreseeable future actions, regardless of what entity undertakes such actions. Cumulative impacts can result from individually minor but collectively significant actions taking place over a period of time.

4.6.1 Alternative A: Proposed Action

Cumulative impacts are not anticipated from implementation of the Proposed Action. No present or future projects are planned for the project area other than the Proposed Action. As presented in Section 4.2.3.3, no cumulative noise impacts are anticipated because of the lack of existing sounds with frequencies characteristic of the WEC system in the project area.

4.6.2 Alternative B: Pearl Harbor Alternative

Cumulative impacts are not anticipated for the alternative site at Pearl Harbor. No present or future projects are planned for the project area other than the proposed WET test. The Pearl Harbor site has restricted public access and is used primarily for ingress and egress of military ships. The entrance channel is dredged approximately every eight years for maintenance. A new effluent outfall in the open coastal waters offshore of Fort Kamehameha will be constructed; however, this would occur east of the Pearl Harbor alternative site. The effluent outfall would not contribute to cumulative impacts pertaining to implementation of the WET test at this site.

4.6.3 Alternative C: No Action

This alternative would not contribute to cumulative impacts.

4.7 IRREVERSIBLE AND IRRETRIEVABLE COMMITMENTS OF RESOURCES

Irreversible commitments are those that cannot be reversed, except perhaps in the extreme long term. Irretrievable commitments are those that are lost for a period of time.

The Navy would commit the resources necessary to complete the installation and testing of up to six WEC buoys in waters with suitable wave energy conditions. There would be an incremental loss of resource materials used in construction of the buoys and transmission cable (e.g., steel and copper). The WET test would not result in an irretrievable loss of resources.

4.8 UNAVOIDABLE ADVERSE EFFECTS

No unavoidable adverse effects would be associated with implementation of the WET project.

4.9 CONCLUSION

Table 4-1 presents a summary of the predicted environmental effects for Alternative A: Proposed Action, Alternative B: Pearl Harbor, and Alternative C: No Action.

Table 4-1. Comparison of Predicted Environmental Effects

Potential Issue/ Impact	Alternatives		
	MCBH Kaneohe Bay Alternative A	Pearl Harbor Alternative B	No Action Alternative C
SHORELINE PHYSIOGRAPHY			
Impacts of installation and operation	No significant impacts are expected. The WEC system would not alter currents or wave directions and there would be no effects on shoreline erosion or sand deposition patterns. Mitigation: none proposed.	Same as Alternative A	No Impacts
Impacts of system removal	No significant impacts are expected. In consultation with the NMFS, USFWS, and DLNR, the Navy would determine at the end of the test period whether equipment installed on the seafloor should be removed or left in place. Land equipment would be removed. Mitigation: none proposed.	Same as Alternative A	No Impacts
OCEANOGRAPHIC CONDITIONS			
	No significant impacts are expected. Implementing the WET test would not affect wave scattering and energy absorption. Mitigation: none proposed.	Same as Alternative A	No Impacts
MARINE BIOLOGICAL RESOURCES			
Impacts to threatened and endangered species and marine mammals protected under the MMPA during installation and operation of the WEC system	No significant impacts are expected. The USFWS and NMFS concur that the Proposed Action is not likely to adversely affect threatened (green sea turtle) and endangered species (hawksbill turtle, humpback whale, and Hawaiian monk seal) under their jurisdictions. Protocols for avoiding impacts to listed protected species during installation activities would be specified in the construction contractor's BMPs. The taking of marine mammals protected under the MMPA is unlikely. Mitigation: none proposed.	If selected, the Navy would initiate informal Section 7 ESA consultation. The taking of marine mammals protected under the MMPA is unlikely. Mitigation: none proposed.	No Impacts

Table 4-1. Comparison of Predicted Environmental Effects *(continued)*

Potential Issue/ Impact	Alternatives		
	MCBH Kaneohe Bay Alternative A	Pearl Harbor Alternative B	No Action Alternative C
MARINE BIOLOGICAL RESOURCES <i>(continued)</i>			
Impacts of installation and anchoring on coral and benthic communities	No significant impacts are expected. Minor impacts would occur on coral and benthic communities along the proposed cable route and at the buoy array site. However, installation of the WEC system has been planned to avoid areas with high percentages of coral coverage. Mitigation: none proposed.	Minor impacts on coral and benthic communities would occur along the cable route. Installation would avoid areas with a high percentage of coral coverage. The buoy array site is essentially devoid of live coral. Mitigation: none proposed.	No Impacts
Impacts to HAPC	The site is not within an HAPC. Mitigation: none proposed.	Same as Alternative A	No Impacts
Impacts to marine mammals or turtles from the risk of entanglement with the cable and entrapment within the buoy	No significant impacts are expected. Entanglement would be a minimal concern as cable installation would occur in shallow water with adequate tension to allow the torque-balanced cable to resist forming loops and contour to the seafloor. Divers would inspect the cable route once it is placed. Entrapment of marine mammals or turtles within the buoy would be of minimal concern since the interior of the structure is free of obstructions, sharp edges or corners. As part of the systems monitoring plan to be developed by the Navy, the system will be examined for entrapment of marine species. Mitigation: none proposed.	Same as Alternative A	No Impacts
Impacts to marine life from exposure to EMR	No significant impacts are expected. The small scale and limited area of disturbance indicate that impacts from EMR on marine organisms would be minor. Impacts of EMR on marine organisms can be expected to range from no impact to avoidance (for bottom-dwelling organisms only) of the vicinity of the WEC cable. Mitigation: none proposed.	Same as Alternative A	No Impacts

Table 4-1. Comparison of Predicted Environmental Effects *(continued)*

Potential Issue/ Impact	Alternatives		
	MCBH Kaneohe Bay Alternative A	Pearl Harbor Alternative B	No Action Alternative C
MARINE BIOLOGICAL RESOURCES <i>(continued)</i>			
Impacts to marine life and divers from potential electrical current leakage	No significant impacts are expected. In the unlikely event that damage to the cable causes an electrical fault, transient effects to marine organisms and divers (mild discomfort) could occur. Electroreceptive species would likely detect the field and be diverted away from the vicinity of the fault during the short period while the ground fault system actuates. Mitigation: none proposed.	Same as Alternative A	No Impacts
Impacts to marine life from potential heat release	There would be no impacts to marine life from potential heat release. Mitigation: none proposed.	Same as Alternative A	No Impacts
Impacts to marine life from noise generated by the system	No significant impacts are expected. Installation noise produced by drilling holes for rock bolts would be localized, intermittent, and of short duration. Operation of the WEC system is expected to produce a continuous acoustic output similar to, but in a higher frequency of, ship traffic. It is unlikely that noise from system installation or operation would have adverse impacts on humpback whales, dolphins, and green sea turtles. The USFWS and NMFS concur with the Navy that the Proposed Action is not likely to adversely affect threatened or endangered species. The taking of marine mammals protected under the MMPA is unlikely during the installation and operation of the WEC system. Mitigation: none proposed.	Same as Alternative A	No Impacts
TERRESTRIAL BIOLOGICAL RESOURCES			
	No threatened or endangered species exist on the proposed project site. Mitigation: none proposed.	Same as Alternative A	No Impacts

Table 4-1. Comparison of Predicted Environmental Effects *(continued)*

Potential Issue/ Impact	Alternatives		
	MCBH Kaneohe Bay Alternative A	Pearl Harbor Alternative B	No Action Alternative C
LAND AND MARINE RESOURCE USE COMPATIBILITY			
	No significant impacts to land and marine resource use are anticipated. Marine resource use incompatibility at the offshore buoy array may result in system security risks. The area is currently open to public access for fishing, boating, and diving. Presently, there are no plans to restrict public access to the buoy array site. The project would not interfere with mission operations at MCBH Kaneohe Bay Mitigation: none proposed.	No significant impacts to land and marine resource use are anticipated. The proposed project would not interfere with mission operations at Pearl Harbor. Mitigation: none proposed.	No Impacts
CULTURAL RESOURCES			
	There would be no effect on historic properties and no impacts to areas within the Mokapu Burial Area (MBA), NRHP Site 50-80-11-1017, where Native Hawaiian human remains are likely to be found. The Hawaii SHPO was consulted on the Proposed Action and concurred with the Navy's finding of no historic properties affected. Mitigation: none proposed.	No impacts on the Pearl Harbor National Historic Landmark. No other cultural resources present. Mitigation: none proposed.	No Impacts
INFRASTRUCTURE			
	No impact Mitigation: none proposed.	Same as Alternative A	No Impacts
RECREATION			
	There would be impacts to recreation outside the 500-yd (457-m) buffer imposed by the presence of the buoy array during the two- to five-year project duration. These impacts would not be significant. Mitigation: none proposed.	No impacts to recreation because the area is used primarily for military ship ingress and egress and the area is off-limits to public access. Mitigation: none proposed.	No Impacts

Table 4-1. Comparison of Predicted Environmental Effects *(continued)*

Potential Issue/ Impact	Alternatives		
	MCBH Kaneohe Bay Alternative A	Pearl Harbor Alternative B	No Action Alternative C
PUBLIC SAFETY			
	<p>There would be potential impacts to public safety outside the 500-yd (457-m) buffer imposed by the presence of the buoy array during the two- to five-year test period.</p> <p>Mitigation: Each buoy would have safety lights and standard USCG signage. The system would be monitored through a combination of automated system and visual observations. A response plan would be developed.</p>	<p>No impacts to public safety because the area is off-limits to public access.</p> <p>Mitigation: similar to Alternative A.</p>	No Impacts
VISUAL RESOURCES			
	<p>Impacts on scenic views would be minimal. Navigational aids from the buoys would extend approximately 30 ft (9 m) above sea level. At night, safety lights on the navigational aids would be visible in the distance.</p> <p>Mitigation: none proposed.</p>	Same as Alternative A	No Impacts

Chapter 5

List of Preparers

CHAPTER 5

LIST OF PREPARERS

Listed below are the identities and backgrounds of the principal preparers who contributed to this EA.

U.S. NAVY

Gary Kasaoka. Planner-in-Charge. B.A. degree in zoology and M.S. degree in science and technology.

Jeannette Simons. Archaeologist. B.A. and M.A. degrees in anthropology.

Stephen Smith. Biologist. B.S. and M.S. degrees in biology.

Julie Rivers. Biologist. B.S. degree in biology.

William Kramer. Biologist. B.S. degree in wildlife biology and M.S. degree in public policy.

BELT COLLINS HAWAII

Lesley Matsumoto, Principal-in-Charge. B.S., atmospheric science. Ms. Matsumoto has over 14 years of environmental consulting experience including environmental planning and feasibility studies. She was responsible for overall project organization and quality control.

Judith Charles, Project Manager. M.P.A., public administration and policy; M.S., soil science; B.S., botany. Ms. Charles' 19 years of multidisciplinary experience encompasses a technical background, environmental planning experience, and knowledge of natural resource policy. She was responsible for project organization and coordination and prepared all sections of the EA.

Sue Sakai, Quality Assurance and Quality Control. M.A. degree in political science. Reviewed document for accuracy, completeness, and consistency.

Maura Mastriani, Associate Environmental Scientist. B.S. degree in environmental science. Contributed to all sections of the EA.

SUBCONSULTANTS

John Clark, Ocean Water Recreation and Safety Consultant. B.A. in Hawaiian studies and Masters in public administration (M.P.A.); prepared ocean activities survey report.

Steve Dollar, Ph.D., Marine Research Consultants. Ph.D. and M.S. degrees in oceanography; conducted surveys and reported on marine biological resources.

Dallas Meggitt, Technical Director of Sound and Sea Technology. B.S. and M.S. degrees in aeronautical engineering, M.S. environmental engineering science; prepared technical report describing the potential impacts of entanglement, entrapment, electromagnetic radiation, heat release, electrical leakage, and noise.

Robert Rocheleau, Ocean Engineer, Sea Engineering Inc. M.S. in Ocean Engineering; prepared technical reports on the coastal and oceanographic setting, and wave energy conversion buoy impact on a wave field.

Chapter 6

References

CHAPTER 6

REFERENCES

- Clark, John (ocean recreation consultant). May 2002. *Marine Public Safety and Recreational Uses Report for the Wave Energy Technology (WET) Test Environmental Assessment*. Prepared for Belt Collins Hawaii Ltd.
- Hawaii Coral Reef Assessment and Monitoring Program (CRAMP). Web site. <http://cramp.wcc.hawaii.edu/Results/Forcing_Functions/Wave_Energy/Hurricane_Waves>; accessed August 23, 2002.
- _____. Web site. <http://cramp.wcc.hawaii.edu/Results/Forcing_Functions/Wave_Energy/Kona_Storm_Waves>; accessed August 23, 2002.
- Marine Research Consultants (MRC). May 2002. *Wave Energy Technology (WET) Marine Corps Base Hawaii Marine Environmental Assessment*. Prepared for Belt Collins Hawaii Ltd.
- National Marine Fisheries Services (NMFS) <<http://www.nmfs.noaa.gov/habitat/habitatprotection/essentialfishhabitat5.htm>>; accessed July 25, 2002.
- Prishmont, L.A. 2000. *Archaeological Subsurface Testing in Conjunction with the Airfield Runway Repairs Project (AARP) in the Mokapu Burial Area, Marine Corps Base Hawaii, Kaneohe Bay*. Prepared by Ogden Environmental and Energy Services Co., Inc. for Pacific Division, Naval Facilities Engineering Command.
- Sea Engineering Inc. (SEI). May 2002a. *Coastal and Oceanographic Setting for WEC Buoy Site Marine Corps Base Hawaii*. Prepared for Belt Collins Hawaii Ltd.
- _____. May 2002b. *Wave Energy Conversion (WEC) Buoy Impact on a Wave Field*. Prepared for Belt Collins Hawaii Ltd.
- Sea Engineering Inc. (SEI) and Makai Ocean Engineering. 2000. *Preliminary Site Assessment of Wave Power Buoy Locations*. Prepared for Ocean Power Technologies, Pennington, New Jersey. July 20, 2000.
- Schilz, A. 1996. *Final Report: Cultural Resources Management Plan, MCBH Kaneohe Bay, Island of Oahu, Hawaii*. Prepared by Ogden Environmental and Energy Services Co., Inc. for Pacific Division, Naval Facilities Engineering Command.
- State of Hawaii Department of Health, Environmental Planning Office Web site. <<http://www.hawaii.gov/doh/eh/epo/303dpcdraft.pdf>> accessed October 4, 2002.
- Sound and Sea Technology Ocean Engineering. July 2002. *Wave Energy Technology (WET) Project Environmental Impacts of Selected Components*. Prepared for Belt Collins Hawaii Ltd.

- Tuggle, H.D. 1999. *A Preliminary Summary of the Bowles Records Concerning Mokapu Excavations, Oahu*. Prepared by International Archaeological Research Institute, Inc. for U.S. Army Engineering District, Honolulu, Hawaii.
- Tuggle, H. David and Robert J. Hommon. 1986. *Historic Property Inventory, Marine Corps Air Station, Kaneohe Bay: History, Survey, and Site Descriptions*. U.S. Naval Facilities Engineering Command, Pacific Division, Pearl Harbor, Hawaii.
- University of Hawaii at Manoa. 1983. *Atlas of Hawaii, Second Edition*. University of Hawaii, Department of Geology, Honolulu.
- U.S. Department of the Navy, Pacific Division. July 2002a. "Marine Natural Resources Insert for the WET EA." Prepared by Steve Smith for Belt Collins Hawaii Ltd.
- _____. October 2001. *Pearl Harbor Naval Complex Integrated Natural Resources Management Plan (INRMP)*. Final. Prepared for Commander Navy Region Hawaii, by Helber Hastert and Fee, Planners
- _____. March 2001. *Final Environmental Impact Statement Outfall Replacement for Wastewater Treatment Plant at Fort Kamehameha, Navy Public Works Center, Pearl Harbor, Hawaii*.
- _____. August 1993. *Draft Final Environmental Assessment For the Construction of a Housing Project at West Loch, Oahu, Hawaii*.
- U.S. Department of the Navy, Pacific Division, Office of Naval Research. July 2002b. *Wave Energy Technology Program Update – Briefing*. Presented by Ron Brackett, Office of Naval Research for Belt Collins Hawaii Ltd.
- U.S. Marine Corps Air Station 1992. *A Natural Resources Survey of the Nearshore Waters of Mokapu Peninsula, Kaneohe Marine Corps Air Station*. Prepared by R. Scott Henderson.
- U.S. Marine Corps Base (MCBH), Kaneohe Bay, Hawaii. May 31, 2002. Personal communication with Gordon Olayvar, Environmental Department.
- _____. November 2001. *Marine Corps Base Hawaii Integrated Natural Resources Management Plan/Environmental Assessment (MCBH INRMP/EA) (2002-2006)*. Volumes 1 and 2. Prepared by Diane C. Drigot, Bruce A. Wilcox, and Kristin N. Duin.
- _____. June 1999. *Final Master Plan. Volume 1 Land Use Plan*. Prepared by Wilson Okamoto and Associates, Inc.
- _____. 1999. MCBH Kaneohe Bay Base Regulations, Chapter 11 Recreational Activities.
- Williams, Scott and Tomasi Patolo. 1998. *Subsurface Survey and Boundary Delimitation of the Mokapu Burial Area, Marine Corps Base Hawaii Kaneohe Bay, Oahu*. Prepared by Ogden Environmental and Energy Services Co., Inc. for Naval Facilities Engineering Command, Pacific Division, Pearl Harbor, Hawaii.

Appendix A-1

Copies of Scoping Letters
for the Proposed Action



DEPARTMENT OF THE NAVY
 PACIFIC DIVISION
 NAVAL FACILITIES ENGINEERING COMMAND
 256 MAKALAPA DR., STE. 100
 PEARL HARBOR, HI 96860-3134

5090P.1F13B
 Ser PLN231/ 624

5090P.1F13B
 Ser PLN231/ 624

Mr. Douglas Tom
 Office of Planning/Coastal Zone Management Program
 Dept of Business, Economic Development and Tourism
 P.O. Box 2359
 Honolulu, HI 96804

Dear Mr. Tom:

The Office of Naval Research (ONR) and Ocean Power Technologies, Inc. (OPT) propose to install, in phases, up to six buoys in approximately 100 feet of water off North Beach at Marine Corps Base Hawaii (MCBH), Kaneohe Bay, to conduct a full-scale ocean test of OPT's wave energy converter (WEC) technology. The objective of the study is to collect data and to demonstrate the technology of using ocean wave power to produce useful amounts of electricity. The project also includes the installation of a power cable from the buoys to the shore to allow the power to be integrated into an existing power grid. All equipment would be removed upon completion of the five-year test period.

The Navy is preparing an Environmental Assessment (EA) for the installation of the buoys and undersea cable that would transmit the generated power to land. As part of the scoping process under the National Environmental Policy Act, we are soliciting your comments on the proposed project, which is described in greater detail in enclosures (1) and (2). A map of the project area is provided as enclosure (3).

In addition to your comments on the scope of this test project, the Navy would appreciate your input on the following questions, as follows:

- a. Does your agency have any natural resources plan or projects that might be directly or indirectly affected by the ONR project?
- b. Are there opportunities for partnering or other associations that would result in improving interagency coordination and cooperation relating to the project?
- c. Do you have relevant baseline information that can be utilized in this project?
- d. Does your agency have any special concerns that you feel should be addressed by the EA?

Please provide your comments to this office by March 22, 2002, using any of the means mentioned to ensure that your input arrives in time to be considered in the project.

Should you have any questions, please contact Mr. Gary Kasaoka (PLN231GK), Navy Environmental Planner, by voice at 471-9338, by facsimile transmission at 474-5909, or via E-Mail at: KasaokaGS@efdpac.navfac.navy.mil.

Sincerely,

MELVIN N. KAKU
 Director
 Environmental Planning Division

Encl:

- (1) General Description of WEC Buoy
- (2) Installation Site Plan at MCBH
- (3) Map of the Project Area off MCBH Kaneohe Bay

General Description and Operation of Wave Energy Converter Buoy

Ocean Power Technology's offshore power system consists of a buoy, equipment canister, undersea power transmission cable, and on-shore electrical power conversion equipment. The up and down motion of the waves propels the buoy in a likewise manner. The power conversion system on the buoy converts the up and down motion into fluid power which is converted to rotary power by means of a hydraulic motor, located on the sea floor below the buoy in the equipment canister. The hydraulic motor spins a generator to produce electrical power, and this power is sent to shore via an undersea transmission cable. On shore, the power is converted to an electric utility grid compatible form. The WEC Buoy design shown below is expected to produce about 25 kilowatts of power. Preliminary estimates of the size of buoy needed to produce this amount of power are about 4.6 meters in diameter and approximately 14.9 m in height.

Main Features:

- Cylindrical, Steel Buoy.
 - Diameter – about 4.6 m,
 - Length – about 14.9 m,
 - Mass – 24 to 35 ton.
- Operates 1.0 - 4.0 meters below surface.
- Nominal System Output: 20 kW.
- Mooring:
 - Rigid spar buoy with universal joint at base.
 - Deadweight and 3 grouted rock anchors provide up to 100-ton holding force.

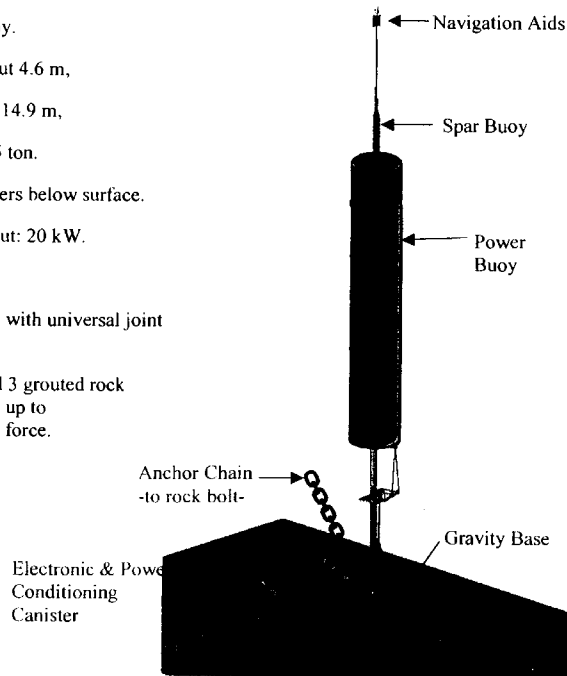

Figure 1. WEC Buoy Configuration

Enclosure (1)

Installation Site Plan at Marine Corps Base Hawaii

The buoy, positioned about 1 meter below the ocean surface, will be anchored in approximately 33 meters of water using a combination of gravity anchor and grouted rock anchors connected to the gravity base with anchor chain. An armored and shielded undersea power cable will transmit electrical power from the buoy to land. The cable will be stabilized on the seafloor using grouted rock bolts and will terminate at a concrete vault that will be placed back from the beach area and above the high water mark. From the vault, a land power cable contained in a conduit will be placed above ground and routed to a bunker located on the side of a hill behind the Officers Housing area. The bunker will house the on-shore electrical power and control equipment consisting of a computer, transformer, AC/DC and DC/DC converters, capacitor bank, battery bank and inverter. From the bunker, power cable will be routed to a grid connection utilizing existing base underground cableways.

Figure 1, below, shows the proposed position of the buoy approximately 3,900 feet from the northeast end of the runway at MCBH. The path of the undersea power transmission cable, shown in yellow, is only approximate at this time. Additional site survey dives will identify the most appropriate route to take advantage of natural crevices in the limestone formation and avoid live coral formations. The land cable route, shown in red, will run from the cable splice vault near the beach to the bunker at the top of the bluff behind the Officers Housing area. From the bunker, the cable will run through existing underground ducts to one of three power substations in the built-up areas.

Figure 1. MCBH Buoy and Cable Installation Site Plan

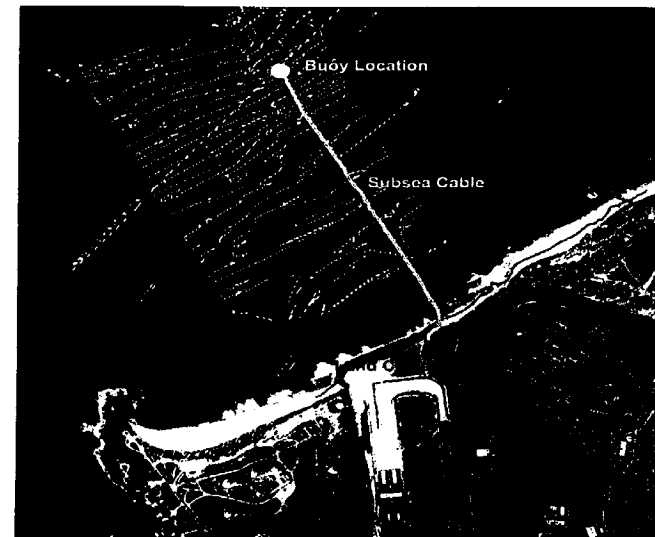

Enclosure (2)

WAVE ENERGY TECHNOLOGY (WET) TEST PROJECT
MCBH Kaneohe Bay, Hawaii

ENCLOSURE (3)

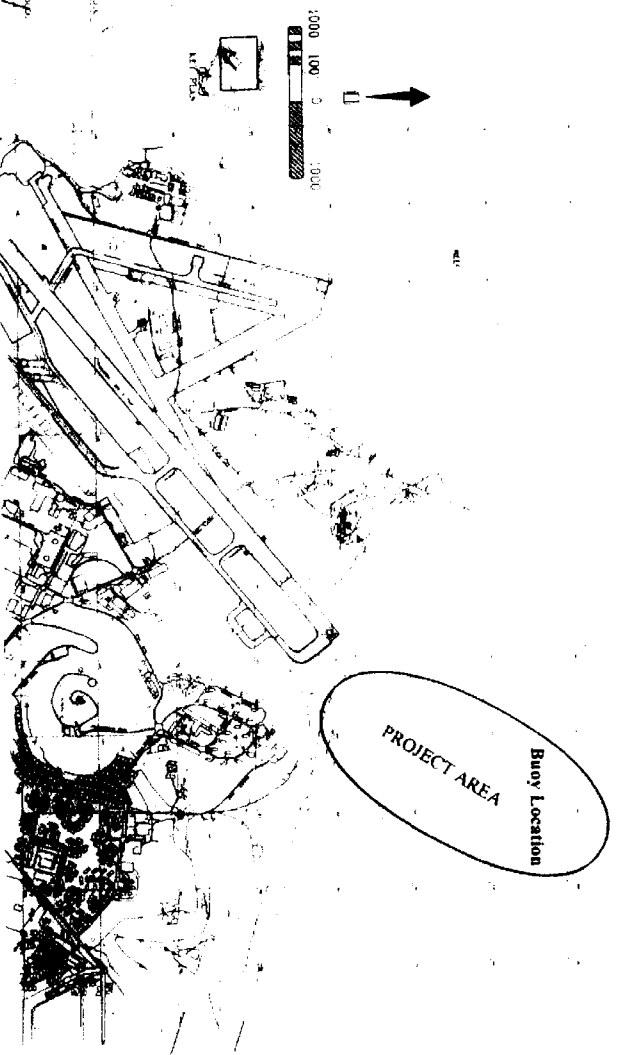



DEPARTMENT OF THE NAVY
 PACIFIC DIVISION
 NAVAL FACILITIES ENGINEERING COMMAND
 258 MAKALAPA DR., STE. 100
 PEARL HARBOR, HI 96860-3134

5090P.1F13B
 Ser PLN231/ 625
 14 MAR 2002

5090P.1F13B
 Ser PLN231/ 625

Dr. Charles Kamella, Administrator
 Pacific Islands Area Office
 National Marine Fisheries Service
 1601 Kapiolani Boulevard, Suite 1110
 Honolulu, HI 96814-4700

Dear Dr. Kamella:

The Office of Naval Research (ONR) and Ocean Power Technologies, Inc. (OPT) propose to install, in phases, up to six buoys in approximately 100 feet of water off North Beach at Marine Corps Base Hawaii (MCBH), Kaneohe Bay, to conduct a full-scale ocean test of OPT's wave energy converter (WEC) technology. The objective of the study is to collect data and to demonstrate the technology of using ocean wave power to produce useful amounts of electricity. The project also includes the installation of a power cable from the buoys to the shore to allow the power to be integrated into an existing power grid. All equipment would be removed upon completion of the five-year test period.

The Navy is preparing an Environmental Assessment (EA) for the installation of the buoys and undersea cable that would transmit the generated power to land. As part of the scoping process under the National Environmental Policy Act, we are soliciting your comments on the proposed project, which is described in greater detail in enclosures (1) and (2). A map of the project area is provided as enclosure (3).

In addition to your comments on the scope of this test project, the Navy would appreciate your input on the following questions, as follows:

- a. Does your agency have any natural resources plan or projects that might be directly or indirectly affected by the ONR project?
- b. Are there opportunities for partnering or other associations that would result in improving interagency coordination and cooperation relating to the project?
- c. Do you have relevant baseline information that can be utilized in this project?
- d. Does your agency have any special concerns that you feel should be addressed by the EA?

Please provide your comments to this office by March 22, 2002, using any of the means mentioned to ensure that your input arrives in time to be considered in the project.

Should you have any questions, please contact Mr. Gary Kasaoka (PLN231GK), Navy Environmental Planner, by voice at 471-9338, by facsimile transmission at 474-5909, or via E-Mail at: KasaokaGS@efdpac.navfac.navy.mil.

Sincerely,

 MELVIN N. KAKU
 Director
 Environmental Planning Division

Encl:

- (1) General Description of WEC Buoy
- (2) Installation Site Plan at MCBH
- (3) Map of the Project Area off MCBH Kaneohe Bay



DEPARTMENT OF THE NAVY
PACIFIC DIVISION
NAVAL FACILITIES ENGINEERING COMMAND
258 MAKALAPA DR., STE. 100
PEARL HARBOR, HI 96860-3134

5090P.1F13B
Ser PLN231/ 623

14 MAR 2002

Mr. Robert Smith *Paul Henson*
U.S. Fish and Wildlife Service
Pacific Islands Ecoregion
300 Ala Moana Blvd., Room 6307
Honolulu, HI 96813

Dear Mr. *Henson* Smith:

The Office of Naval Research (ONR) and Ocean Power Technologies, Inc. (OPT) propose to install, in phases, up to six buoys in approximately 100 feet of water off North Beach at Marine Corps Base Hawaii (MCBH), Kaneohe Bay, to conduct a full-scale ocean test of OPT's wave energy converter (WEC) technology. The objective of the study is to collect data and to demonstrate the technology of using ocean wave power to produce useful amounts of electricity. The project also includes the installation of a power cable from the buoys to the shore to allow the power to be integrated into an existing power grid. All equipment would be removed upon completion of the five-year test period.

The Navy is preparing an Environmental Assessment (EA) for the installation of the buoys and undersea cable that would transmit the generated power to land. As part of the scoping process under the National Environmental Policy Act, we are soliciting your comments on the proposed project, which is described in greater detail in enclosures (1) and (2). A map of the project area is provided as enclosure (3).

In addition to your comments on the scope of this test project, the Navy would appreciate your input on the following questions, as follows:

- a. Does your agency have any natural resources plan or projects that might be directly or indirectly affected by the ONR project?
- b. Are there opportunities for partnering or other associations that would result in improving interagency coordination and cooperation relating to the project?
- c. Do you have relevant baseline information that can be utilized in this project?
- d. Does your agency have any special concerns that you feel should be addressed by the EA?

Please provide your comments to this office by March 22, 2002, using any of the means mentioned to ensure that your input arrives in time to be considered in the project.

5090P.1F13B
Ser PLN231/ 623

Should you have any questions, please contact Mr. Gary Kasaoka (PLN231GK), Navy Environmental Planner, by voice at 471-9338, by facsimile transmission at 474-5909, or via E-Mail at: KasaokaGS@efdpac.navfac.navy.mil.

Sincerely,

Melvin N. Kaku
MELVIN N. KAKU
Director
Environmental Planning Division

Encl:

- (1) General Description of WEC Buoy
- (2) Installation Site Plan at MCBH
- (3) Map of the Project Area off MCBH Kaneohe Bay



DEPARTMENT OF THE NAVY
PACIFIC DIVISION
NAVAL FACILITIES ENGINEERING COMMAND
258 MAKALAPA DR., STE. 100
PEARL HARBOR, HI 96860-3134

5090P.1F13B
Ser PLN231/ 622
14 MAR 2002

5090P.1F13B
Ser PLN231/ 622

Mr. William Devick
Division of Aquatic Resources
Department of Land and Natural Resources
1151 Punchbowl Street, Room 330
Honolulu, HI 96813

Dear Mr. Devick:

The Office of Naval Research (ONR) and Ocean Power Technologies, Inc. (OPT) propose to install, in phases, up to six buoys in approximately 100 feet of water off North Beach at Marine Corps Base Hawaii (MCBH), Kaneohe Bay, to conduct a full-scale ocean test of OPT's wave energy converter (WEC) technology. The objective of the study is to collect data and to demonstrate the technology of using ocean wave power to produce useful amounts of electricity. The project also includes the installation of a power cable from the buoys to the shore to allow the power to be integrated into an existing power grid. All equipment would be removed upon completion of the five-year test period.

The Navy is preparing an Environmental Assessment (EA) for the installation of the buoys and undersea cable that would transmit the generated power to land. As part of the scoping process under the National Environmental Policy Act, we are soliciting your comments on the proposed project, which is described in greater detail in enclosures (1) and (2). A map of the project area is provided as enclosure (3).

In addition to your comments on the scope of this test project, the Navy would appreciate your input on the following questions, as follows:

- a. Does your agency have any natural resources plan or projects that might be directly or indirectly affected by the ONR project?
- b. Are there opportunities for partnering or other associations that would result in improving interagency coordination and cooperation relating to the project?
- c. Do you have relevant baseline information that can be utilized in this project?
- d. Does your agency have any special concerns that you feel should be addressed by the EA?

Please provide your comments to this office by March 22, 2002, using any of the means mentioned to ensure that your input arrives in time to be considered in the project.

Should you have any questions, please contact Mr. Gary Kasaoka (PLN231GK), Navy Environmental Planner, by voice at 471-9338, by facsimile transmission at 474-5909, or via E-Mail at: KasaokaGS@efdpac.navfac.navy.mil.

Sincerely,

MELVIN N. KAKU
Director
Environmental Planning Division

Encl:

- (1) General Description of WEC Buoy
- (2) Installation Site Plan at MCBH
- (3) Map of the Project Area off MCBH Kaneohe Bay



DEPARTMENT OF THE NAVY
PACIFIC DIVISION
NAVAL FACILITIES ENGINEERING COMMAND
258 MAKALAPA DR., STE. 100
PEARL HARBOR, HI 96860-3134

5090P.1F13B
Ser PLN231/ 627

14 MAR 2002

From: Commander, Pacific Division, Naval Facilities Engineering Command
To: Commander, U.S. Army Corps of Engineers District, Honolulu (CEPOH-EC-R)
Fort Shafter, HI 96858-5440

Subj: WAVE ENERGY TECHNOLOGY (WET) TEST PROJECT AT MCBH KANEOHE
BAY, HAWAII -- SCOPING FOR AN ENVIRONMENTAL ASSESSMENT

Encl: (1) General Description of WEC Buoy
(2) Installation Site Plan at MCBH
(3) Map of Project Area off MCBH Kaneohe Bay

1. The Office of Naval Research (ONR) and Ocean Power Technologies, Inc. (OPT) propose to install, in phases, up to six buoys in approximately 100 feet of water off North Beach at Marine Corps Base Hawaii (MCBH), Kaneohe Bay, to conduct a full-scale ocean test of OPT's wave energy converter (WEC) technology. The objective of the study is to collect data and to demonstrate the technology of using ocean wave power to produce useful amounts of electricity. The project also includes the installation of a power cable from the buoys to the shore to allow the power to be integrated into an existing power grid. All equipment would be removed upon completion of the five-year test period.
2. The Navy is preparing an Environmental Assessment (EA) for the installation of the buoys and undersea cable that would transmit the generated power to land. As part of the scoping process under the National Environmental Policy Act, we are soliciting your comments on the proposed project, which is described in greater detail in enclosures (1) and (2). A map of the project area is provided as enclosure (3).
3. In addition to your comments on the scope of this test project, the Navy would appreciate your input on the following questions, as follows:
 - a. Does your agency have any natural resources plan or projects that might be directly or indirectly affected by the ONR project?
 - b. Are there opportunities for partnering or other associations that would result in improving interagency coordination and cooperation relating to the project?
 - c. Do you have relevant baseline information that can be utilized in this project?
 - d. Does your agency have any special concerns that you feel should be addressed by the EA?

Subj: WAVE ENERGY TECHNOLOGY (WET) TEST PROJECT AT MCBH KANEOHE
BAY, HAWAII -- SCOPING FOR AN ENVIRONMENTAL ASSESSMENT

4. Please provide your comments to this office by 22 March 2002, using any of the means mentioned below to ensure that your input arrives in time to be considered in the project.
5. Should you have any questions, please contact Mr. Gary Kasaoka (PLN231GK), Navy Environmental Planner, by voice at 471-9338, by facsimile transmission at 474-5909, or via E-Mail at: KasaokaGS@efdpac.navfac.navy.mil.

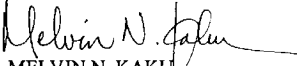
MELVIN N. KAKU
By direction



DEPARTMENT OF THE NAVY
PACIFIC DIVISION
NAVAL FACILITIES ENGINEERING COMMAND
258 MAKALAPA DR., STE. 100
PEARL HARBOR, HI 96860-3134

5090P.1F13B
Ser PLN231/ 626

14 MAR 2002

From: Commander, Pacific Division, Naval Facilities Engineering Command
To: Commander, U.S. Coast Guard, 14th Coast Guard District, 300 Ala Moana Blvd.,
Honolulu, HI 96850

Subj: WAVE ENERGY TECHNOLOGY (WET) TEST PROJECT AT MCBH KANEHOHE
BAY, HAWAII - SCOPING FOR AN ENVIRONMENTAL ASSESSMENT

Encl: (1) General Description of WEC Buoy
(2) Installation Site Plan at MCBH
(3) Map of Project Area off MCBH Kaneohe Bay

1. The Office of Naval Research (ONR) and Ocean Power Technologies, Inc. (OPT) propose to install, in phases, up to six buoys in approximately 100 feet of water off North Beach at Marine Corps Base Hawaii (MCBH), Kaneohe Bay, to conduct a full-scale ocean test of OPT's wave energy converter (WEC) technology. The objective of the study is to collect data and to demonstrate the technology of using ocean wave power to produce useful amounts of electricity. The project also includes the installation of a power cable from the buoys to the shore to allow the power to be integrated into an existing power grid. All equipment would be removed upon completion of the five-year test period.

2. The Navy is preparing an Environmental Assessment (EA) for the installation of the buoys and undersea cable that would transmit the generated power to land. As part of the scoping process under the National Environmental Policy Act, we are soliciting your comments on the proposed project, which is described in greater detail in enclosures (1) and (2). A map of the project area is provided as enclosure (3).

3. In addition to your comments on the scope of this test project, the Navy would appreciate your input on the following questions, as follows:

a. Does your agency have any natural resources plan or projects that might be directly or indirectly affected by the ONR project?

b. Are there opportunities for partnering or other associations that would result in improving interagency coordination and cooperation relating to the project?

c. Do you have relevant baseline information that can be utilized in this project?

d. Does your agency have any special concerns that your feel should be addressed by the EA?

Subj: WAVE ENERGY TECHNOLOGY (WET) TEST PROJECT AT MCBH KANEHOHE
BAY, HAWAII -- SCOPING FOR AN ENVIRONMENTAL ASSESSMENT

4. Please provide your comments to this office by 22 March 2002, using any of the means mentioned below to ensure that your input arrives in time to be considered in the project.

5. Should you have any questions, please contact Mr. Gary Kasaoka (PLN231GK), Navy Environmental Planner, by voice at 471-9338, by facsimile transmission at 474-5909, or via E-Mail at: KasaokaGS@efdpac.navfac.navy.mil.

MELVIN N. KAKU
By direction



DEPARTMENT OF THE NAVY
PACIFIC DIVISION
NAVAL FACILITIES ENGINEERING COMMAND
258 MAKALAPA DR., STE. 100
PEARL HARBOR, HI 96860-3134

5090P.1F13B
Ser PLN231/ 761

2 8 MAR 2002

Mr. W. Mason Young, Administrator
Boating and Ocean Recreation Division
Department of Land and Natural Resources
333 Queen Street, Suite 300
Honolulu, HI 96813

Dear Mr. Young:

The Office of Naval Research (ONR) and Ocean Power Technoligics, Inc. (OPT) propose to install, in phases, up to six buoys in approximately 100 feet of water off North Beach at Marine Corps Base Hawaii (MCBH), Kaneohe Bay, to conduct a full-scale ocean test of OPT's wave energy converter (WEC) technology. The objective of the study is to collect data and to demonstrate the technology of using ocean wave power to produce useful amounts of electricity. The project also includes the installation of a power cable from the buoys to the shore to allow the power to be integrated into an existing power grid. All equipment would be removed upon completion of the five-year test period.

The Navy is preparing an Environmental Assessment (EA) for the installation of the buoys and undersea cable that would transmit the generated power to land. As part of the scoping process under the National Environmental Policy Act, we are soliciting your comments on the proposed project, which is described in greater detail in enclosures (1) and (2). A map of the project area is provided as enclosure (3).

In addition to your comments on the scope of this test project, the Navy would appreciate your input on the following questions, as follows:

- a. Does your agency have any natural resources plan or projects that might be directly or indirectly affected by the ONR project?
- b. Are there opportunities for partnering or other associations that would result in improving interagency coordination and cooperation relating to the project?
- c. Do you have relevant baseline information that can be utilized in this project?
- d. Does your agency have any special concerns that you feel should be addressed by the EA?

Please provide your comments to this office by April 5, 2002, using any of the means mentioned below to ensure that your input arrives in time to be considered in the project.

5090P.1F13B
Ser PLN231/ 761

Should you have any questions, please contact Mr. Gary Kasaoka (PLN231GK), Navy Environmental Planner, by voice at 471-9338, by facsimile transmission at 474-5909, or via E-Mail at: KasaokaGS@efdpac.navfac.navy.mil.

Sincerely,

MELVIN N. KAKU
Director
Environmental Planning Division

Encl:

- (1) General Description of WEC Buoy
- (2) Installation Site Plan at MCBH
- (3) Map of the Project Area off MCBH Kaneohe Bay

Appendix A-2

Agency Responses for the Proposed Action

BENJAMIN J. CAYetano
GOVERNOR OF HAWAII



STATE OF HAWAII
DEPARTMENT OF LAND AND NATURAL RESOURCES
DIVISION OF AQUATIC RESOURCES
1161 PUNCHBOWL STREET
HONOLULU, HAWAII 96813

GILBERT S. COLOMA-AGARAN
CHAIRPERSON
BOARD OF LAND AND NATURAL RESOURCES

DEPUTY DIRECTOR
ERIC T. HIRANO

DEPUTY DIRECTOR
FOR THE COMMISSION ON
WATER RESOURCES MANAGEMENT
LINNEL T. NISHIOKA

AQUATIC RESOURCES
BOATING AND OCEAN RECREATION
COMMISSION ON WATER RESOURCES
MANAGEMENT
CONSERVATION AND RESOURCES
ENFORCEMENT
CONVEYANCES
FORESTRY AND WILDLIFE
HISTORIC PRESERVATION
KAWAII OLYMPIC ISLAND RESERVE
COMMISSION
LAND
STATE PARKS

4/01/02

Melvin Kaku, Director, Environmental Planning Division
Department of the Navy, Pacific Division
Naval Facilities Engineering Command
258 Makalapa Dr., Ste. 100
Pearl Harbor, HI 96860-3134

Post-it* Fax Note	7671	Date	6/20	# of pages	2
To	Gary Kasaoka	From	Dave Gulko		
Co./Dept.		Co.	DLNR/DAR		
Phone #		Phone #	587-0318		
Fax #	474-5909	Fax #	587-0115		

Mr. Kaku:

Thank you for the opportunity to comment on the proposal to install up to six buoys in approximately 100 feet of water off North Beach at the Marine Corps Base Hawai'i (MCBH), Kane'oh'e Bay. We have a number of preliminary concerns regarding the proposed project which are outlined below.

1. Kane'oh'e Bay is currently one of the greatest problem spots in the entire State for invasive and/or alien seaweeds. A number of species that are overgrowing and killing off coral habitat in the bay are currently not found immediately outside the bay or anywhere else in Hawai'i. We have extremely strong concerns regarding research, construction or military efforts which might inadvertently result in the introduction of these devastating species outside of the areas in which they already occur. Our agency would welcome the opportunity to work directly with you to develop protocols to prevent such an occurrence if this project is to move forward at this location.
2. The Installation Site Plan proposes to site at least 3,900 feet of cable from the buoy locations shoreward and place such cable in "natural crevices". As the proposed site is presumably exposed to relatively high wave energy given its location and the needs of the project, we have concerns regarding the ecological impact of siting cable into crevices which may serve as primary fish & invertebrate recruitment sites for this location. We would need to conduct a site visit with our biologists to determine if this is a real concern and how it might effect the marine natural resources in the area.
3. The buoys are proposed to be located in 100 feet of water in an area that receives large winter surf. Without having visited the area and detailing the bottom cover, we are concerned as to lateral movement of the proposed anchoring system and its effect on the bottom substrate. If the location used is within State waters and results in either impact to State natural resources or prevents the public use of State resources a number of Divisions within DLNR may have concerns, require additional permits, and/or require public hearings on the proposed project.
4. No information is provided regarding the length of each of the three anchoring chains or area of the gravity base. Given that six of these buoys are proposed, each being roughly 49 feet long and 15 feet wide, we are concerned regarding the footprint that each of these anchoring systems will have on bottom habitat.

5. Recent data from the NWHI and American Samoa suggests that large pieces of metal left atop coral reef habitats for extended periods of time may result in facilitating the growth and expansion of cyanobacteria or blue-green algae (*Lyngby* spp.). Given the suggested relatively large size of the anchoring system and the length of the experiment (five years), there may be concerns regarding such an event occurring with this proposed research.
6. Will noise generated from the buoy itself or movement of the anchoring system effect protected species such as turtles or whales known to frequent the area? Likewise, is there an entanglement risk posed by this system to wildlife protected under State and Federal laws?
7. Other than placing the Buoy-to-Shore cables in crevices, what mechanisms would be employed to prevent lateral movement as a result of high wave energy? Such lateral movement would have a "bulldozing effect" on sessile benthic marine organisms.
8. What types of monitoring are proposed for this project? Specifically, how will biological impacts be monitored and what protocols are proposed to minimize such impacts?

If you have any questions, please call Mr. David Gulko at (808) 587-0318. Thank you for your assistance with this matter.

Sincerely,

William S. Devick, Administrator
Division of Aquatic Resources

Cc: Francis Oishi, DAR
Dave Gulko, DAR
Richard Sixberry, DAR
Gary Kasaoka, Planner, USN



DEPARTMENT OF THE ARMY
U. S. ARMY ENGINEER DISTRICT, HONOLULU
FT. SHAFTER, HAWAII 96858-5440

REPLY TO
ATTENTION OF

CEPOH-EC-R (1145b)

9 October 2002

MEMORANDUM FOR MR. MELVIN N. KAKU (PLN231), PACIFIC
DIVISION, NAVAL FACILITIES ENGINEERING COMMAND, 258 MAKALAPA
DRIVE, STE. 100, PEARL HARBOR, HAWAII 96860-3134

SUBJECT: Review of Draft Environmental Assessment (EA) for
Proposed Wave Energy Technology (WET) Project at Marine
Corps Base Hawaii (MCBH), Kaneohe Bay, Hawaii

1. Reference your memorandum, 5090P.ONR ser PLN23/2456,
subject as above, dated 2 Oct 02.
2. A Department of the Army (DA) permit will be required
for the referenced activity.
3. Point of Contact for this action is Mr. William Lennan,
CEPOH-EC-R at 438-6986 or FAX 438-4060, File No. 200200243.

A handwritten signature in cursive script, reading "George P. Young", is positioned above the typed name.

GEORGE P. YOUNG, P.E.
Chief, Regulatory Branch

Appendix A-3

CZMA Negative Determination Notice for the Proposed Action



DEPARTMENT OF THE NAVY
PACIFIC DIVISION
NAVAL FACILITIES ENGINEERING COMMAND
258 MAKALAPA DR., STE 100
PEARL HARBOR, HI 96860-3134

5090P.1F13B
Ser PLN231/ 1219

5090P.1F13B
Ser PLN231/ 1219
24 MAY 2002

Mr. David W. Blane, AICP, Director
Hawaii Office of Planning
Department of Business, Economic Development & Tourism
P.O. Box 2359
Honolulu, HI 96804

Dear Mr. Blane:

Subj: COASTAL ZONE MANAGEMENT ACT (CZMA) NEGATIVE
DETERMINATION NOTICE OFFICE OF NAVAL RESEARCH AND
OCEAN POWER TECHNOLOGIES, INC. PROPOSED FULL-SCALE
OCEAN TEST OF WAVE ENERGY CONVERTER (WEC)
TECHNOLOGY AT MARINE CORPS BASE HAWAII (MCBH),
KANEHOE BAY, HAWAII

Pacific Division, Naval Facilities Engineering Command (PACNAVFACENGCOCM), on behalf of its client, the Office of Naval Research (ONR), and the host activity, MCBH Kaneohe Bay, wishes to inform you that a consistency determination is not required (i.e., negative determination) under the CZMA for the subject project.

ONR proposes to install and operate as many as six WEC buoys off North Beach, MCBH Kaneohe Bay. The primary purpose of the project is to test the equipment under actual sea conditions and to collect empirical data on technology performance. Along with the buoys that will be positioned in the water at about 100-ft depth and approximately 4,100 ft from shore, the project includes laying specially constructed, armored, undersea transmission cable to shore to convey the electricity to an existing power grid at the officers' housing area aboard the base. A land cable would connect the undersea cable and the power grid. It is proposed to traverse the Mokapu Burial Area, which is listed on the National and State Register of Historic Places. ONR proposes to do so with great sensitivity to the Burial Area. Routing towards previously disturbed sections of the beach, by eliminating any subsurface ground disturbance, and by avoiding areas known to contain burials, would influence cable alignment.

A description of the proposed project was provided to your staff in the Coastal Zone Management Program by a Navy project scoping letter dated March 14, 2002 (PACNAVFACENGCOCM 5090P.1F13B Ser PLN231/624), which you responded to by correspondence dated March 22, 2002 (DBEDT-OP Ref. No. P-9413). Several enclosures were provided to help your staff visualize where the buoys and undersea cable would be situated in relations to Mokapu Peninsula, where we propose to site the project. A schematic drawing of the WEC buoy was also among the material provided.

Enclosures (1) through (4) are some additional materials describing updated project information. Enclosure (2) is an aerial photograph of the proposed land cable route, which was not shown in detail earlier.

The Navy believes that a consistency determination is not required because the proposed project will be wholly on or over Federal lands, which are excluded from the Hawaii Coastal Zone. Additionally, the proposed action will not have reasonably foreseeable direct and indirect effects on any coastal use or resource of the State's coastal zone under your cognizance.

Please contact Mr. Gary Kasaoka (PLN231GK) at (808) 471-9338, should you have any questions.

Sincerely,

MELVIN N. KAKU
Director
Environmental Planning Division

Encl:

- (1) Project Location Map
- (2) Land Cable Route
- (3) Undersea Cable Route and Buoy Array
- (4) Schematic Drawing of WEC Buoy Unit

Copy to:
Office of Naval Research (Code 334)
800 N. Quincy Street
Arlington, VA 22217-5660

Naval Facilities Engineering Service Center (NFESC)
Ocean Engineering Department (Code ESC 52)
1100 23rd Avenue
Port Hueneme, CA 90043

MCBH Kaneohe Bay
I & L Directorate (Code LE)
Kaneohe Bay, HI 96863-3002

Appendix A-4

ESA Section 7 Correspondence for the Proposed Action



DEPARTMENT OF THE NAVY
PACIFIC DIVISION
NAVAL FACILITIES ENGINEERING COMMAND
258 MAKALAPA DR., STE. 100
PEARL HARBOR, HI 96860-3134

5090P.1F13B
PLN231/ 2119

5090P.1F13B
PLN231/ 2119

26 AUG 2002

Dr. Charles Karnella, Administrator
Pacific Islands Area Office
National Marine Fisheries Service
1601 Kapiolani Boulevard, Suite 1110
Honolulu, Hawaii 96814-4700

Dear Dr. Karnella:

Subj: REQUEST FOR INFORMAL SECTION 7, ENDANGERED SPECIES ACT,
CONSULTATION REGARDING WAVE ENERGY CONVERSION PROJECT
AT MARINE CORPS BASE HAWAII (MCBH), KANEOHE BAY, HAWAII

The Department of the Navy (Navy) is proposing a phased installation and testing of up to six Wave Energy Conversion (WEC) buoys off North Beach at Marine Corps Base Hawaii (MCBH) Kaneohe Bay to gather data on WEC buoy technology. The project would commence as early as the end of 2002 and would extend over a five-year test period. We request your review of this proposed action and seek your concurrence with our determination that although species under the jurisdiction of the National Marine Fisheries Service (NMFS) that are listed as endangered and threatened occur in the vicinity of the project area, none will be adversely affected by the project. We seek your concurrence in accordance with Section 7 of the Endangered Species Act (ESA). We also request your review of this proposal relative to Essential Fish Habitat (EFH) and Coral Reef Protection, as promulgated under the Magnuson-Stevens Fishery Conservation and Management Act and Executive Order No. 13089, respectively

The Pacific Division, Naval Facilities Engineering Command (PACDIV) provided a preliminary briefing to Mr. John Naughton, Ms. Margaret Akamine-Dupree, and Mr. David Nichols of your agency on May 23, 2002. Other attendees at the briefing were Mr. Antonio Bentivoglio and Mr. Michael Molina of the U.S. Fish and Wildlife Service (USFWS); Mr. David Gulko of the State of Hawaii Department of Land and Natural Resources (DLNR-Division of Aquatic Resources); Mr. William Lennan of the U.S. Army Corps of Engineers (USACE); Dr. Steven Dollar of Marine Research Consultants; Dr. Diane Drigot and Mr. Gordon Olayvar from MCBH Kaneohe Bay; Mr. Gary Kasaoka, Mr. Kendall Kam, Ms. Julie Rivers, Mr. Stephen Smith, and Mr. William Kramer from PACDIV; and Ms. Judith Charles and Ms. Maura Mastriani from Belt Collins Hawaii, the A-E firm preparing the Environmental Assessment for the project.

Mr. Naughton accompanied Dr. Steven Dollar on two underwater site assessments of the project area on April 10, 2002 and April 12, 2002. This letter incorporates information presented in the preliminary briefing and is supported in part by observations made by these marine biologists during the site assessment dives.

Project Description

The Commanding General of MCBH Kaneohe Bay proposes to allow the Office of Naval Research (ONR) and Ocean Power Technologies, Inc. (OPT) to install up to six WEC buoys and supporting equipment in waters directly to the north of the base [Enclosures (1) and (2)]. Each buoy would be anchored in approximately 100 ft. (30 m) of water using a heavily ballasted anchor ringed by a flange, and rock bolted to the seafloor. The WEC buoy is comprised of a cylinder, a buoyancy tank, and a central rigid spar buoy. The buoy cylinder moves up and down the spar buoy creating motion that is converted to useable energy. The buoy cylinder is a hollow steel unit approximately 15 ft (4.5 m) in diameter and 49 ft (15 m) long. It is attached to the buoyancy tank and is designed to float 3 to 13 ft (1 to 4 m) below the surface. The spar buoy, constructed of steel is positively buoyant. It is fixed to a ballasted anchor and keeps the system upright while it sways back and forth with the waves. A universal joint allows motion of the buoy on two axes. Enclosures (3) and (4) are depictions of the WEC buoy.

An equipment canister attached to the seafloor nearby would convert mechanical energy to electrical energy for one to six buoys. Cables from individual buoys would each have a designated attachment point to the equipment canister. An armored and shielded undersea cable connected to the equipment canister would transmit electrical power to land. The undersea cable would be stabilized on the seafloor using grouted rock bolts and protective split pipe.

Four mooring buoys will be positioned at the perimeter of the buoy field for use during the installation phase and in the maintenance program for the duration of the project. The mooring buoy and the proposed placement of the buoys are shown on enclosures (5) and (6). The mooring consists of a small cylindrical float that is used to mark the site and to caution boaters to stay clear of the submerged buoys. The float is attached to a clump by a synthetic mooring line. The clump would weigh in water about 7,000 lbs (3,175 kg) and should not move even under storm conditions. As insurance, a 100-ft anchor chain would be used to tie the clump to a grouted rock bolt. The purpose of these buoys is to establish a 4-point mooring arrangement to provide stability for an 80-ft boat that will be used as a diving platform and to ensure there is no accidental contact with any of the WEC buoys during installation and maintenance. The dive boat would attach mooring lines to each of the four mooring buoys and position itself at the desired location by adjusting the payout of the lines.

On land, the cable would be anchored to the basalt using a rock bolt and spliced to a land power cable inside a pre-fabricated, concrete utility vault placed on shore above the high water mark. From the utility vault, the land power cable contained in a conduit would be elevated off the ground using concrete pedestal and routed to Battery French (BF), a partially buried concrete structure located on the hillside behind the Officers' Housing Area. BF would house the on-shore electrical power and control equipment. From BF, the power cable would be routed to the existing electrical grid using existing underground duct banks.

The National Environmental Policy Act (NEPA) requires that all reasonable alternatives to the proposed action be considered and analyzed. In addition to the no-action alternative, there is a third alternative that would site the project at Pearl Harbor, Hawaii. See enclosure (7). In essence, the project at that location would require placing the buoy field outside the Pearl Harbor Entrance Channel, across the channel and to the west of the distal end (diffuser) of the new outfall for the Navy's Wastewater Treatment Plant at Fort Kamehameha (Project No. P-497). The land-based portion of the test project would be located in Building No. 562 at the West Loch Branch of Naval Magazine Pearl Harbor. The buoy field and Building 562 would be linked with a 2.4-mile undersea cable running along the western edge of the entrance channel and for a short distance along the western shoreline of the estuary. Should this alternative be selected, the Navy will develop and submit appropriate engineering and biological analyses to NMFS for your review and comments in accordance with Section 7 and other applicable environmental guidelines and regulations.

Statutory Requirements

The ESA requires the Navy to evaluate the potential effects of its actions on listed and proposed threatened and endangered species and designated and proposed critical habitat. Section 7 of the ESA requires Federal agencies, in consultation with NMFS and the U.S. Fish and Wildlife Service (USFWS), to ensure that their actions do not jeopardize the continued existence of these species or destroy or adversely modify critical habitat. The Navy has determined that the proposed action will not adversely affect any species or habitats under the jurisdiction of USFWS (green sea turtles [*Chelonia mydas*] on land) and has sought their concurrence with this determination.

Four of the Federally declared threatened and endangered species of sea turtles and marine mammals recorded in Hawaiian waters are known to occur within the project area. The threatened green sea turtle occurs commonly in the nearshore areas of Hawaii and is known to feed on selected species of marine algae. The green sea turtle is known to frequent the proposed project area. Evidence of green sea turtle nesting attempts have been discovered in vicinity of Fort Hase beach at the eastern perimeter of the base and at the beach below Pond Road on the western side of Ulupa`u Crater Head, near North Beach. The endangered hawksbill turtle (*Eretmochelys imbricata*) is found infrequently in Hawaiian waters. Records of hawksbill turtle sightings within the project area are not available. However, none of the common algal assemblages noted in the project area consist of the preferred forage species for turtles and none of the physical structure of the reef surface would constitute preferred resting habitat for sea turtles.

Populations of the endangered humpback whale (*Megaptera novaeangliae*) are known to winter in the Hawaiian Islands from December to April. Humpback whales have been observed in waters as shallow as 15 feet (4.6 meters) and are frequently sighted in the project area during the winter months. The Hawaiian monk seal (*Monachus schauinslandi*) has also been observed

sporadically in the main Hawaiian Islands. Occasional sightings of monk seals have been reported in the nearshore waters of the project area.

The Magnuson-Stevens Fishery Conservation and Management Act (MSFCMA) established a management system to more effectively utilize marine fishery resources. One of the purposes of the MSFCMA is to promote the protection of essential fish habitat (EFH), which is defined as "those waters and substrate necessary to fish for spawning, breeding, feeding or growth to maturity." The Western Pacific Regional Fishery Management Council has designated all the ocean waters surrounding Oahu, from the shore to depths of over 100 feet as Essential Fish Habitat, for one or more species under their jurisdiction. However, none of the EFH within the proposed project area has been designated as Habitat Area of Particular Concern (HAPC).

Executive Order No. 13089, Coral Reef Protection, is intended to preserve and protect the biodiversity, health, heritage and social and economic value of U.S. coral reef ecosystems and the marine environment. Federal agencies are required to identify their actions that may affect coral reef ecosystems; to utilize their programs and authorities to protect and enhance the ecosystems; and, to the extent permitted by law, ensure that their actions would not degrade the conditions of such ecosystems.

Potential Impacts

Reasonable foreseeable potential impacts to marine species from this project may occur from the following:

- installation and anchorage effects on coral and benthic communities
- entanglement and entrapment
- noise
- EMR
- potential electrical leakage
- potential heat release from cable and canister

Results of analysis of these potential impacts are discussed in enclosure (8).

Based on the analysis and evaluation provided, the Navy has determined that the proposed actions are not likely to adversely affect endangered and threatened species under your jurisdiction or coral reefs. We respectfully request your concurrence with our determination.

5090P.1F13B
PLN23T/ 2119

Should you have any questions about this project, please contact the undersigned at 471-9338, or be facsimile transmission at 474-5909.

Sincerely,

MELVIN N. KAKU
Director
Environmental Planning Division

Enclosures:

- (1) Project Map
- (2) Proposed Undersea Cable Route at MCBH Kaneohe Bay
- (3) Buoy, Anchor, and Canister Configuration
- (4) WEC Buoy Cutaway
- (5) Mooring Buoy Assembly
- (6) Proposed Buoy Field
- (7) Pearl Harbor Alternative Cable Route and Buoy Site
- (8) WEC Buoy Test Project

Copy to:

U.S. Fish and Wildlife Service
Pacific Islands Ecoregion
Box 50088
Honolulu, HI 96850

State of Hawaii
Department of Land and Natural Resources
Division of Aquatic Resources
1151 Punchbowl Street
Honolulu, HI 96813

ENCLOSURE (1)

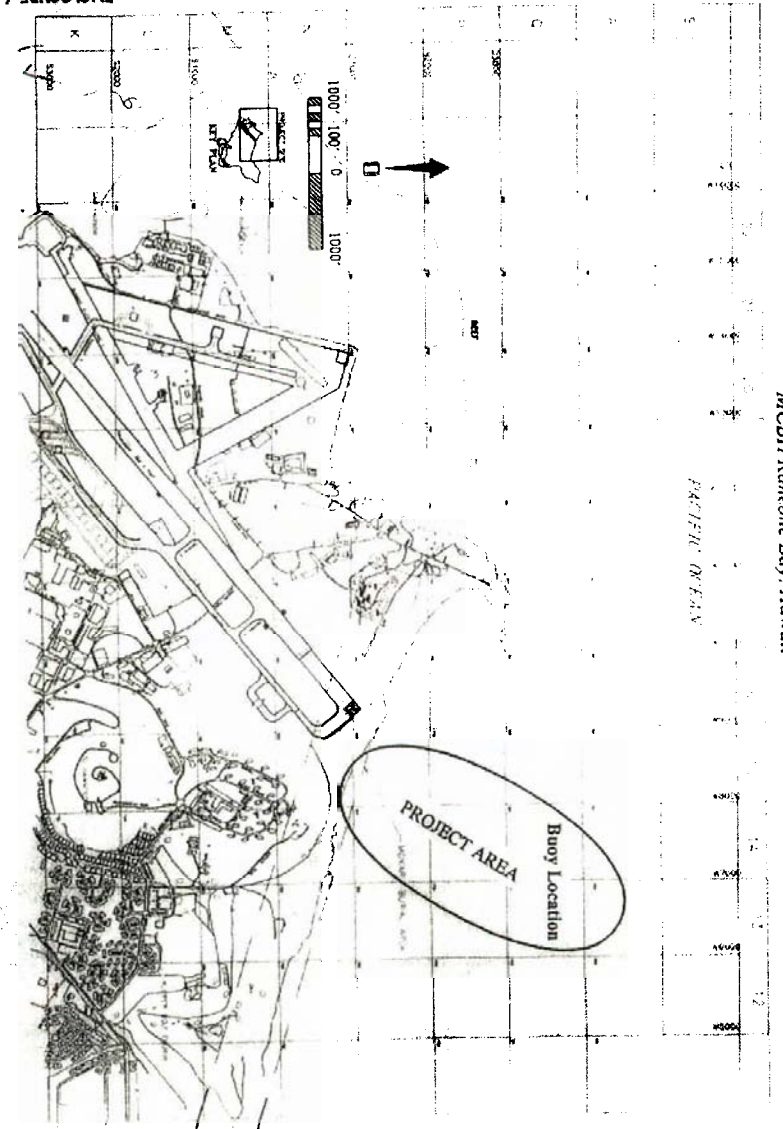

Buoy, Anchor & Canister

MAIN FEATURES

CYLINDRICAL STEEL BUOY
 MASS 24-TONS (22 METRIC TONS)
 TO 35-TONS (32 METRIC TONS)

OPERATES 3 FEET (1.0 m) TO 13 FEET
 (4.0 m) BELOW SURFACE

NOMINAL SYSTEM OUTPUT: 20 KW

MOORING
 BIG D SPAR BUOY WITH UNIVERSAL
 JOINT AT BASE

DEADWEIGHT AND GROUND ROCK
 ANCHORS PROVIDE UP TO 100-TON
 (91 METRIC TONS) HOLDING FORCE

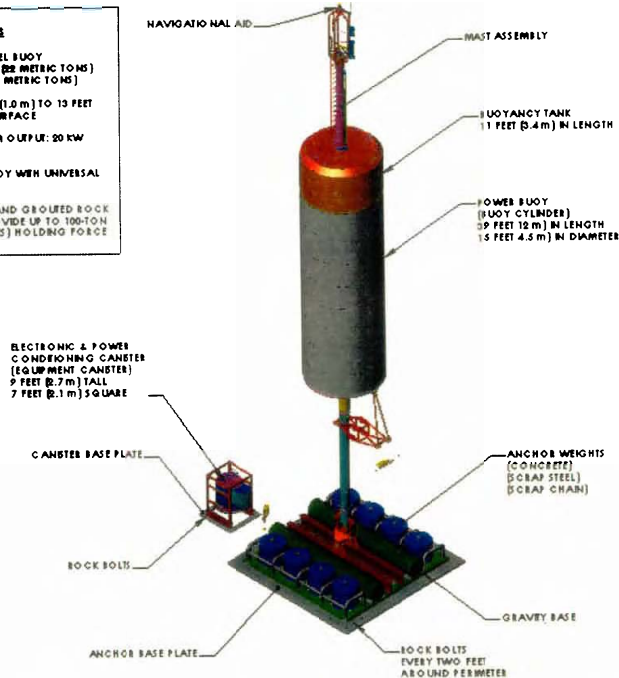

ENCLOSURE (3)

Complete Buoy with new anchor and canister configuration

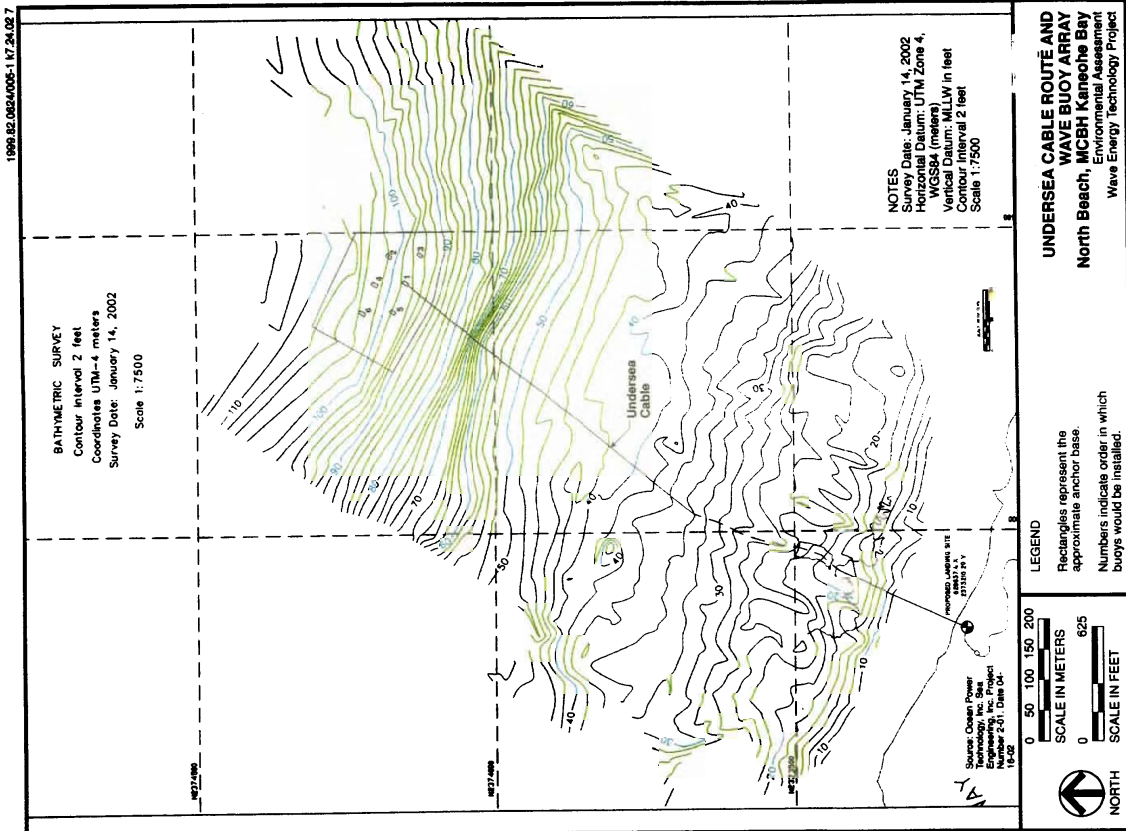

Work Boat Mooring Configuration

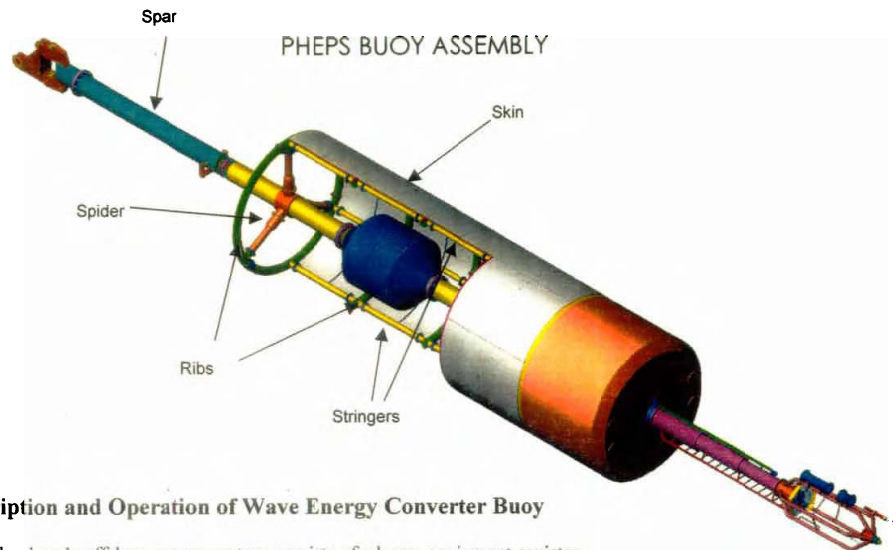
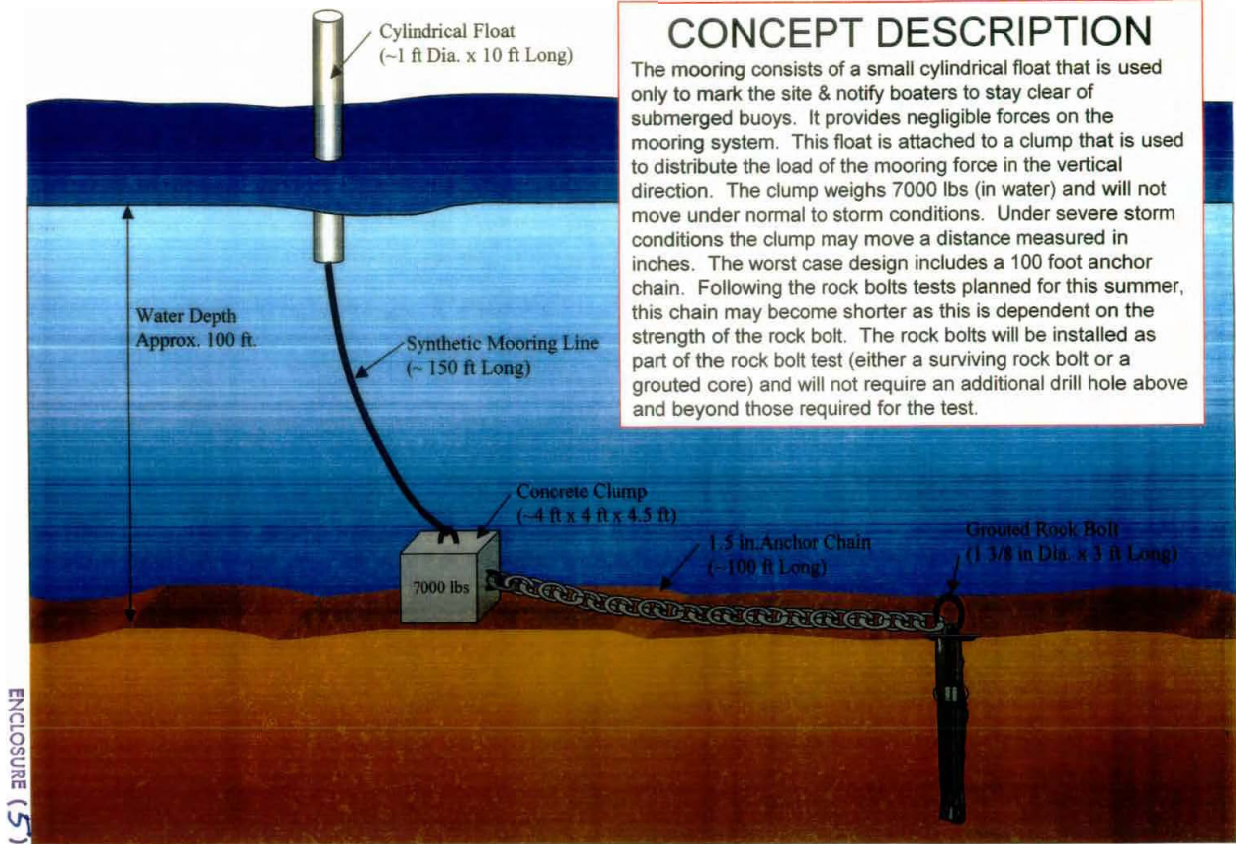

General Description and Operation of Wave Energy Converter Buoy

Ocean Power Technology's offshore power system consists of a buoy, equipment canister, sub sea power transmission cable, and on-shore electrical power conversion equipment. The up and down motion of the waves propels the buoy in a likewise manner. The power conversion system on the buoy converts the up and down motion into fluid power which is converted to rotary power by means of a hydraulic motor, located on the sea floor below the buoy in the equipment canister. The hydraulic motor spins a generator to produce electrical power, and this power is sent to shore via a sub sea transmission cable. On shore, the power is converted to an electric utility grid compatible form. The WEC Buoy design proposed for use in the first two phases of this program is expected to produce about 25 kilowatts of power. Preliminary estimates of the size of buoy needed to produce this amount of power are about 4.5 to 5 meters in diameter and 12 to 20 meters in height.

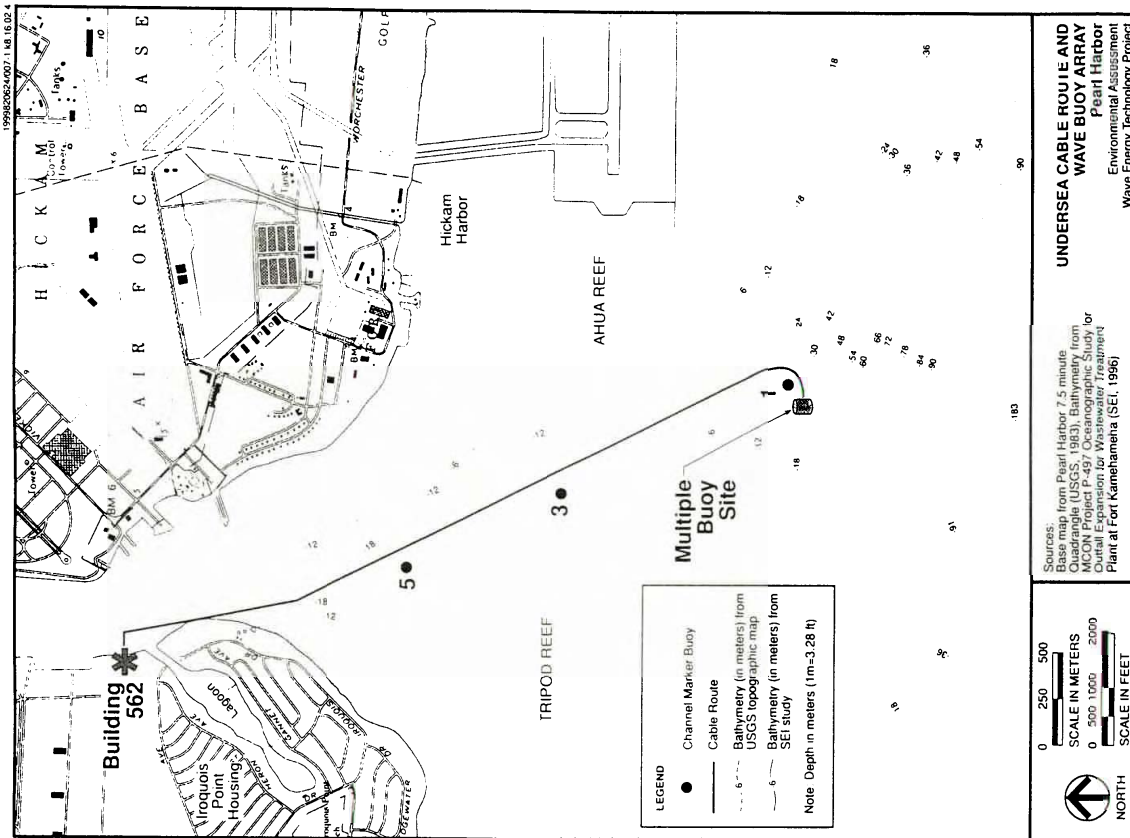

Sources:
 Base map from Pearl Harbor 7.5 minute
 Microgrid (USGS, 1983). Bathymetry from
 Military Operations Research Institute for
 Duffell Expansion for Wastewater Treatment
 Plant at Fort Kamehameha (SEI, 1996)

0 250 500
 SCALE IN METERS
 0 500 1000 2000
 SCALE IN FEET

NORTH

UNDERSEA CABLE ROUTE AND
 WAVE BUOY ARRAY
 Pearl Harbor
 Environmental Assessment
 Wave Energy Technology Project

ENCLOSURE (7)

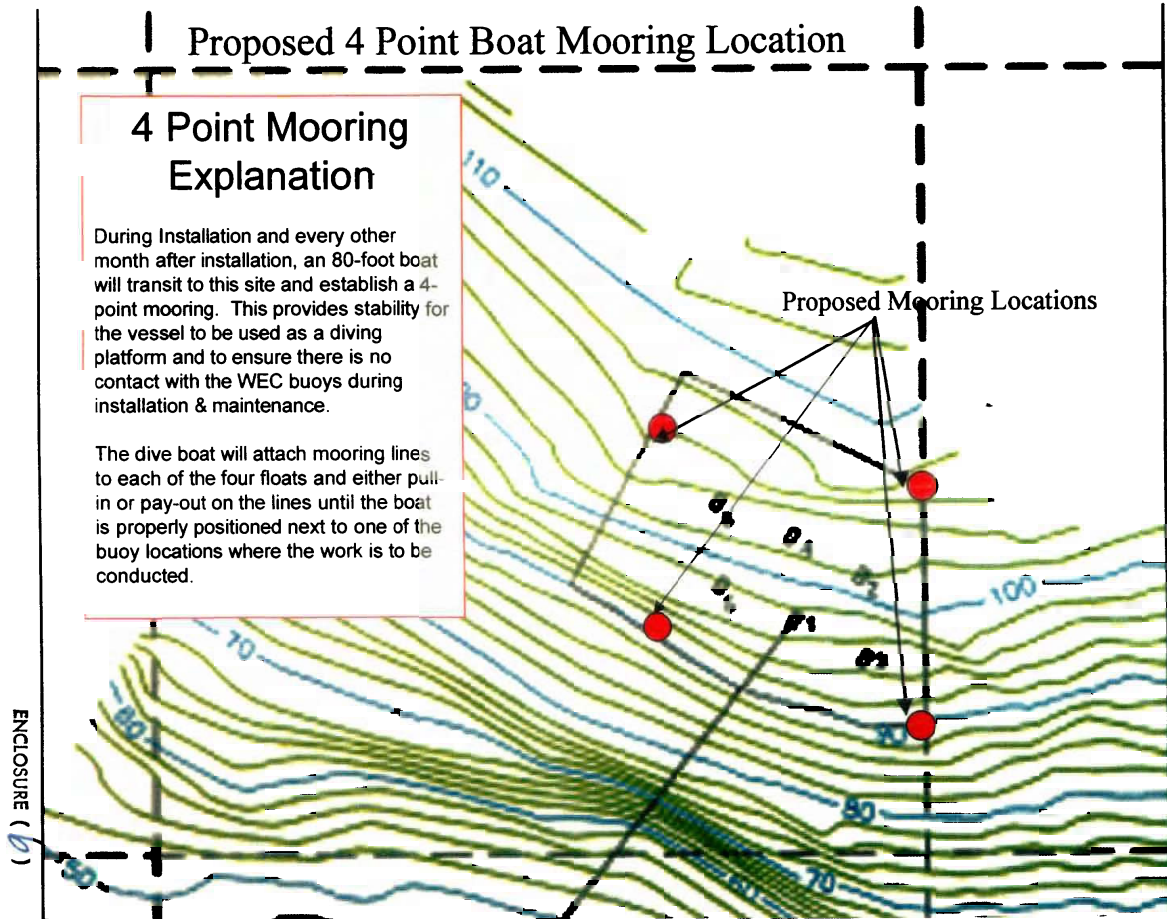

Proposed 4 Point Boat Mooring Location

4 Point Mooring Explanation

During Installation and every other month after installation, an 80-foot boat will transit to this site and establish a 4-point mooring. This provides stability for the vessel to be used as a diving platform and to ensure there is no contact with the WEC buoys during installation & maintenance.

The dive boat will attach mooring lines to each of the four floats and either pull-in or pay-out on the lines until the boat is properly positioned next to one of the buoy locations where the work is to be conducted.

Proposed Mooring Locations

ENCLOSURE (8)

**WAVE ENERGY CONVERSION BUOY TEST PROJECT
AT MCBH KANEOHE BAY, HAWAII**

1. SUBMERGED FEATURES AT PROJECT SITE

The physical characteristics of the nearshore bottom off North Beach can be described by several bands or zones that approximately parallel the shoreline and are defined by water depth. Figure 1 provides a schematic depiction of the zones.

Sand-Boulder Zone. The ocean bottom just seaward of the beach is sandy, with some widely scattered outcrops of scoured limestone. The sand cover extends to about the 15-foot (4.6 m) water depth. This zone ranges from a width of 400 feet (122 m) at the east end of the beach to 700 feet (213 m) near Pyramid Rock. The sandy area immediately off the base runway may shift seasonally, with the limestone outcrops alternately being buried and exposed. The substratum from the shoreline through the sand-boulder zone contains little marine vegetation or coral as a result of continuous resuspension of sand with passing waves.

Sand Channel Zone. Seaward of the sand-boulder zone, the bottom consists of consolidated limestone bisected by small channels, known as spur and groove formations, some of which contain a thin veneer of sand. There are typically 3- to 4-foot (0.9-1.2 m) elevation changes between the bottom of the channels and the adjacent ridges. This zone extends from approximately the 15-foot (4.6 m) depth to the 35-foot (10.7 m) depth. While the channel bottoms are typically flat, scoured limestone with a veneer of sand occasionally present, some coral is present on the ridges. The spur and groove formations are generally oriented at right angle to the shoreline. The channels vary in width and eventually dead end in ridge formations. In the sand channel zone, scattered heads of the branching coral *Pocillopora eydouxi* grow along the vertical sides of the reef channels.

Limestone Plateau. The spur and groove formations end around the 30 to 35 foot (9 to 11 m) water depth, and the bottom from that point to approximately the 50-foot (15 m) depth is a wide plateau of relatively solid, flat limestone. Some scattered areas of vertical relief exist, generally due to potholing, coral growth or the presence of small limestone ridges and ledges.

On the reef limestone plateau, vegetative cover increases with a short algal turf on the surface of the plateau, binding a thin layer of carbonate sediment. Macrobiota in this zone include sporadic heads of the coral *Pocillopora meandrina*, flat encrustations of the corals *Porites lobata*, *Montipora capitata*, *M. patula*, and *M. flabellata*. Aggregations of the red calcareous algae genera *Porolithion* also occur on the plateau. Coral growth is greater along the edge of the ledges than the flat areas, and fish are more likely to frequent the areas of coral growth. Colonies of *Pocillopora eydouxi* up to two feet in height occur infrequently in this zone with schools of the damselfish *Dascyllus albisella* resident on the coral.

Enclosure (8)

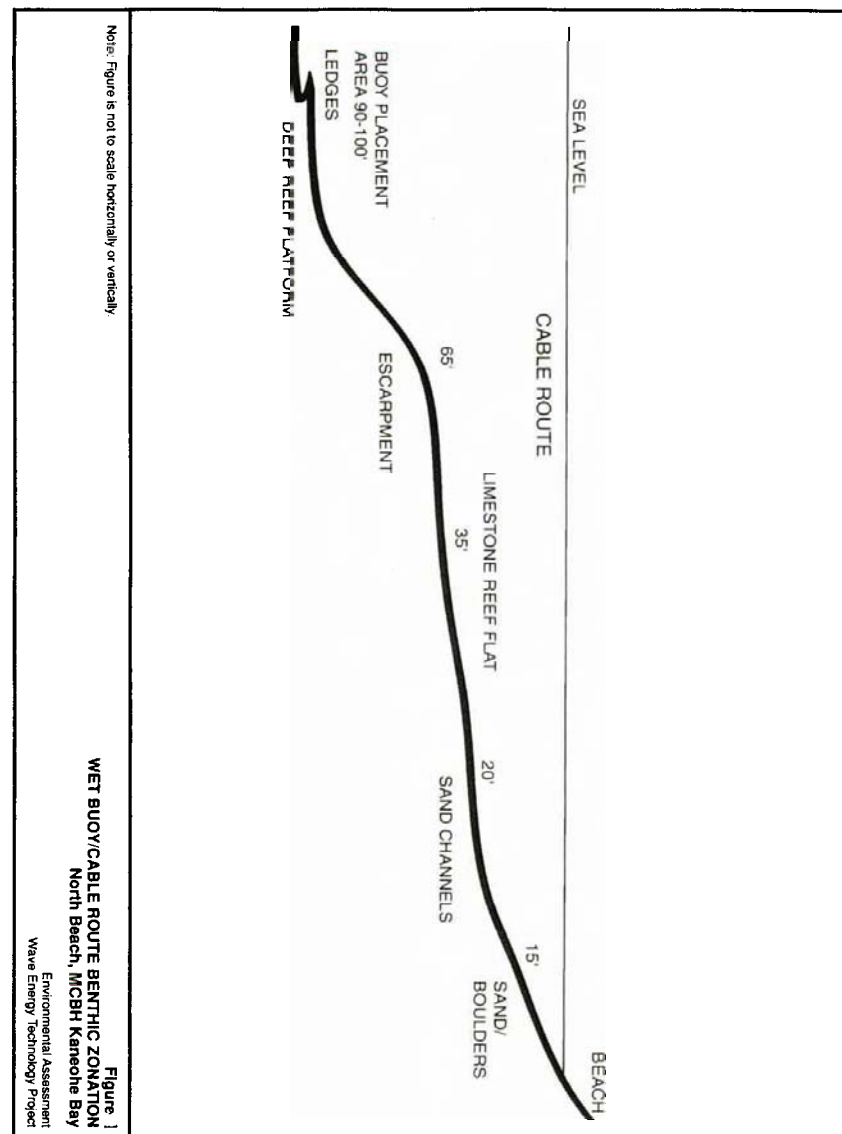

Escarpment Zone. The bottom slope increases from seaward of the 50-foot (15 m) contour to approximately the 95-foot (29 m) depth contour. No prominent vertical ledges or undercut areas are present in the project area. The bottom is relatively flat limestone with widely scattered areas of vertical relief. In the escarpment zone, the primary species of coral is the flat encrusting *Montipora capitata*. In some localized areas bottom cover of this species comprises up to 50 percent of the substrate.

Deep Reef Platform Zone. Seaward of the 95-foot (29 m) contour, the bottom slope flattens out and the limestone bottom becomes almost featureless. There is a thin veneer of sand one to two inches (1.5 to 5.1 cm) thick over the limestone in some areas. The bottom topography remains relatively constant and barren through the depth range of the zone in the proposed project area. In the deep reef platform zone, the zone where the proposed buoy array would be located, bottom composition is relatively homogenous. The flat, pitted limestone surface is covered with a veneer of algal turf binding a thin layer of sediment. The dominant coral species in this zone are scattered heads of *Pocillopora meandrina* and flat encrustations of *Montipora capitata*. Coral coverage in this zone varies from relatively heavy cover above the 95-foot (29 m) depth contour to relatively little cover below this boundary.

A system of small undercut ledges exists at the far eastern end of the proposed project area. These ledges run parallel with the depth contours. A ledge about 25 feet (7.6 m) long exists at the 93-foot (28 m) depth and a 150-foot (46 m) long ledge system exists around the 100-foot (30 m) depth contour. Initial plans for placement of the buoy array had to be altered in order to avoid these ledges and were subsequently moved further west to an area of lower biological diversity.

2. CABLE AND BUOY INSTALLATION

2.1 Undersea Cable Installation

On the day before laying the undersea cable, divers would lay a wire rope along the proposed cable route through the zone of irregular bottom, from about the 18- to the 30-foot (5.5- to 9.1-m) water depth, a distance of approximately 700 feet (213.4 m). The rope would be placed along the optimum cable route to avoid as much vertical relief as possible and to guide the main cable installation. The wire would be installed using DGPS for initial positioning and final DGPS readings taken following positioning by the divers.

The proposed landing point for the cable is adjacent to the northeast corner of the shoreline revetment constructed for the runway (Figure 2). On the day of installation, a vessel would be anchored with a fourpoint mooring directly off the landing site as close as the surf permits (10- to 15-ft [3- to 4.6-m] water depth, approximately 450 ft. offshore [137 m]). The land end of the cable would be fastened to a cable sled to protect the cable from entangling with undersea boulders while transiting through the surf zone (Figure 3). The vessel would then move seaward from the shore, deploying the cable off its stern, with divers working in the water positioning the cable along the marked route. The vessel's linear cable winch would allow the cable to be laid at a constant tension. Once the vessel has reached the site of buoy number 1, the end of the cable would be lowered to the bottom.



Fig. 2. Proposed Landing Point North Beach, MCBH Kaneohe Bay

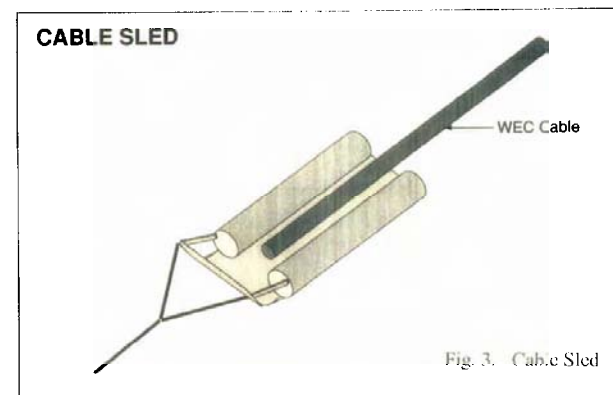

Fig. 3. Cable Sled

The undersea cable would be anchored along its entire length by either rock bolts or protective split pipe with the type of anchoring and spacing being determined by the conditions at each location along the alignment (e.g., the substrate) (Figure 4). Anchoring the cable would be especially important in areas with turbulence, such as the surf zone. Divers would set the bolts and encase the cable in the split pipe. No trenching would be used. Divers would inspect the final location of the cable. Anchoring of the cable along its entire route may be completed following the initial day of installation. Excess cable would be placed on the seafloor in a figure eight configuration between buoys number 1 and number 2 and secured with rock bolts.

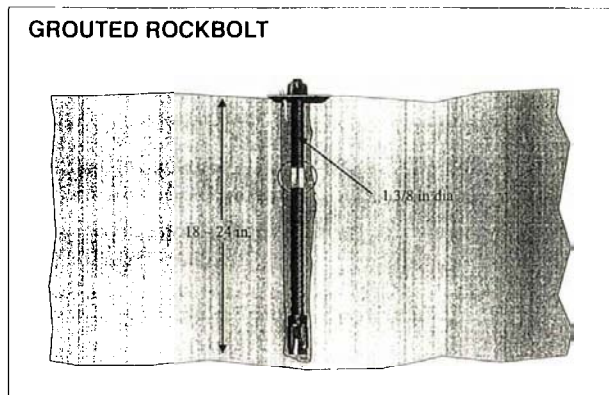

Fig. 4. Grouted Rockbolt

Shoreline excavation would not be required for the cable installation. The cable route would take advantage of existing sand channels through spur and groove formations in the limestone up to the 50-foot (15 m) depth. While the channels to some extent provide a suitable cable route, none offer a continuous path through these zones. Some areas with significant vertical relief must be crossed and the cable would be secured to the seafloor with rock bolts to prevent scouring. The cable route avoids areas of high relief to the maximum extent possible. Some areas of 3-foot (0.9 m) relief would be crossed in the zone between the 15-foot (4.57 m) and 35-foot (10.67 m) water depths. Controlling cable tension during installation would minimize cable bridging and spanning across high points.

The cable route from the 50-foot (15 m) depth to the buoy array site at the 90-100 foot (27 m to 30 m) depth would traverse a fairly flat limestone bottom covered by a one to two inch (2.5 to 5 cm) veneer of sand. The cable would be stabilized on the bottom using grouted rock bolts.

Anchoring the cable along the entire route would prevent the cable from moving with heavy wave action and reduce wear on the cable. Installing grouted rock bolts for the protective split pipe cover would require drilling into the limestone bottom, and would avoid areas with coral outcrops and rich biological diversity.

Negative effects on Federally protected marine species are not anticipated from the cable installation, but beneficial effects on marine biological resources would include increased abundance of coral along the cable route due to settlement and subsequent growth of corals on the cable itself.

2.2 Buoy Installation and Anchorage

The buoy array would be installed at a depth of approximately 100 feet (30 m), in the deep reef platform zone. The WEC buoys and anchors would be constructed on O'ahu and assembled on land at Honolulu Harbor, which would also serve as the initial staging area. All deployment activities and vessels would start out from this point. The selected site for the buoys and anchors would be pre-marked with a marking buoy, and identified with latitude and longitude coordinates. The location would be pinpointed with GPS navigational systems for accuracy. The actual method of deployment of the buoys and anchors is dependent on final design considerations and vessel capabilities. The buoy, anchor, and equipment canister may be installed separately.

The anchor would be towed or trucked from Honolulu Harbor to MCBH Kaneohe Bay. If towing were the case, air would be pumped into the ballast tanks of the anchor to make it float. At the deployment site, the ballast tanks in the anchor would be flooded with water and the anchor lowered to the seafloor. Upon positioning of the anchor base at the desired location, additional mass would be lowered to the bottom and placed on to the gravity base. Afterwards, the frame would be rock-bolted to the seafloor.

The buoy may be towed from Honolulu Harbor behind a tug or on a barge. Alternatively, the buoy could be trucked to Kaneohe Bay to avoid risk of encountering high seas and higher costs of going by sea. At the deployment site, the buoy column would be winched down from the deployment vessel and connected to the anchor base. Divers would assist in the attachment of the buoy column with the anchor.

The canister would be deployed separately from the anchor and buoy. It would be lowered with a winch to the seafloor and secured with rock bolts. Divers would connect electrical cables and hydraulic hoses to the canister.

The deep, reef platform zone is not considered an area of high biological diversity nor does it support HAPC. The proposed deployment of the WEC buoys would result in minimal effects on marine biota. There would not be negative effects on commercially or recreationally important species. It is believed that the buoys will function as unintended fish-aggregating device (FAD).

The anchoring system was designed to minimize the potential for bottom scour. The massive weight of the anchor base would prevent the buoy assembly from lifting off of the seafloor in the event of an extreme storm. The buoys would be coated with antifouling paint to prevent colonization of fouling organisms on the buoy surface. The gravity base of the buoys, on the other hand, would not be coated with antifouling paint to encourage the growth of coral on the surface. The rationale being that perhaps the anchor base would be more suitably abandoned in place at the end of the test trials for the betterment of the benthic community vice uprooted at the expense of the bottom dwellers and the concomitant loss of valuable surface area at the bottom.

As the buoys would not be deployed in waters at any other location prior to placement at the MCBH Kaneohe Bay site, the potential for introducing alien algal species is minimal to none.

2.3 SYSTEM MONITORING

The WEC system would be monitored by a combination of automated systems and visual observations. An automated GPS system on each buoy would continuously monitor the buoy's location and alert appropriate personnel if it were to stray. At least once every 24 hours, the presence of the buoys would be verified through a visual inspection of the system and by means of its on-board navigational features. Personnel would inspect shore based electrical equipment for safety on a routine basis. Approximately once every two months, a contractor would perform a diving inspection of the submerged systems to observe and record system wear, and to note potential safety issues not apparent from other visual and automated monitoring efforts.

2.4 SYSTEMS REMOVAL

Upon completing of the systems test, the Navy shall decide whether some or all of the in-water buoy components should be removed or left in place. The plan is to solicit the advice of the NMFS and DLNR as to whether the benefits of abandoning some components in place would outweigh any negative effects of uprooting the hardware from a system, which by that time would have stabilized with the surrounding biota. One way of thinking is that leaving some of the hardware on the seafloor may actually enhance the marine environment by providing successful coral recruitment sites and an overall improved fish habitat.

3. ENTANGLEMENT

3.1 Undersea Cable

The WEC cable would have the following characteristics:

- Installation would occur with adequate slack to allow the cable to have full contact with the features of the seafloor, without being suspended by high points. Divers would inspect the cable route once it is placed.
- Installation would occur in shallow water, i.e., depths to about 100 ft (30.5 m).
- The length of the cable is relatively short, about 3,900 ft (1,190 m).
- The cable is intended to be torque balanced and resistant to forming loops.

Placement of the entire undersea cable is anticipated to be completed in one day while anchoring of the cable for its entire length may require an additional day, weather permitting.

The species of concern that may appear in the area during WEC system installation are the green sea turtle, hawksbill sea turtle, Hawaiian monk seal, and the humpback whale. The limited duration of the WEC cable installation operations and the placement of the cable flat on the seafloor minimize the risk of these species encountering or becoming entangled in the WEC cable.

3.2 Entrapment

The potential for entrapment of marine species such as sea turtles or monk seals within the WEC buoy structure is minimal. The top of the buoy is closed, and the bottom is open, allowing ingress and egress through only one end. There is potential for an animal to enter the buoy and become disoriented; however, the size of the opening in the bottom of the WEC buoy provides a ready egress path. During daylight hours, light from the open end of the buoy would allow animals to orient themselves to the exit. There are no entanglement or snagging obstructions within the interior of the buoy to prevent egress. No horizontal flat surfaces exist within the buoy to provide resting habitat for animals (e.g., turtles).

In addition, because the internal structural components are round, they do not present entanglement or snagging obstructions.

4. NOISE

The possible effects on marine life from noise associated with buoy installation and operations are being considered by the noise subconsultant and will be discussed in the Environmental Assessment. Drilling into the seafloor to install rock bolts would generate noise, but the noise should not be excessive. Operational noises would be very similar to sounds commonly associated with anchored large watercrafts.

5. ELECTROMAGNETIC RADIATION (EMR)

Power cables generate both electric and magnetic fields. Based on the anticipated current passing through the undersea cable, the electric field strength at the surface of the cable would range from approximately 1.5 millivolts (mV) to a maximum of 10.5 mV, and would decrease exponentially with distance from the cable. The magnetic field strength at the surface of the cable would range from approximately 0.1 amperes (amps.) to a maximum of 0.8 amps., and would decrease exponentially with distance from the cable.

There are four behavioral scenarios related to magnetic detection of the cables: (1) detection and no effect, (2) detection and confusion, (3) detection and avoidance or (4) attraction. The first scenario is highly probable since the cable would be carrying alternating current rather the polarized direct current. In the second scenario, the individual may disrupt its current behavior while it "reanalyzes" the situation. The expected outcome is for the individual to assess the information from other sensory cues, ignore the anomalous magnetic perception and continue its previous behavior.

Chondrichthyans (includes sharks, rays, and skates) with highly developed sensory systems in the vicinity of the cable and close to the seabed may be temporarily disoriented and confused by their electrosensory information. Bottom-dwelling organisms would be the most likely to show avoidance behavior while pelagic species could readily swim over and away from the EMR field.

Since the cable does not cross any known critical migratory paths for threatened and endangered species and since the cabling does not create a physical barrier, avoidance behavior should not be a concern for the local marine populations.

The small scale and limited area of disturbance indicate that the EMR effects should be minimal on marine species in the project site. Animals sensitive to electrical or magnetic fields may be able to detect emissions in the vicinity of the WEC cable; however, the effects are anticipated to be temporary.

6. ELECTRICAL FAULT IMPACTS

It is possible that during operation, the WEC system might experience an electrical fault or short to seawater. If there is a fault, the computer-controlled electrical fault detection and circuit interruption system shunts the electrical current to the load resistors in from 6 milliseconds (ms) to 20 ms, limiting the duration of the electrical field created by a fault. If the fault persists, an electric field is set up in the vicinity of the fault with a voltage gradient that depends on the fault current and the distance from the fault.

A series of U.S. Navy studies on the effects of electrical fields found that fault durations of less than 20 ms and fault currents of less than 5 mV had only transitory effects on marine life or divers. Divers were generally observed to experience only mild discomfort. With the WEC system, this period of exposure could last from 6 ms to 20 ms. No literature was found directly describing the effects of this type of highly transitory electrical field on marine life or divers. It is likely that electroreceptive species would simply detect the field and be diverted away from the vicinity of the fault during the brief period while the ground fault system actuates.

The WEC undersea cable is armored with steel wires and has an external jacket that makes it highly resistant to damage. A fault induced by either fishing or boat anchors is considered unlikely. In addition, protection from leakage has been designed into the system. The electrical system incorporates a computer-controlled fault detection and interruption system that would divert the electric current from the cable into load resistors in the event of a fault. No long-term effects from electrical leakage are anticipated as the duration of leaks would be extremely short.

7. POTENTIAL HEAT RELEASE

7.1 Undersea Cable

The resistive losses in the undersea cable have been calculated to be from 20 milliwatts (mW) per foot (0.9 m) of cable for a single buoy generating 20 kilowatts of power, to approximately 1.4 watts per foot of cable (0.9 m) in the case of up to six buoys generating 250 kW. Based on the calculated resistive losses, the temperature rise in the cable has been estimated at less than 0.018 °F (0.01°C) for a single buoy to less than 0.025°F (0.023°C) for six buoys.

There are no impacts to the seafloor or benthic flora or fauna expected from potential heat release from operation of the WEC system. No impacts on demersal species are expected.

The water in the vicinity of the cable is expected to be in constant motion and, thus, well mixed. Because of the motion of the water, any heat convected from the cable would be dissipated essentially instantaneously. Heating of the seawater in the immediate vicinity of the cable would be negligible, due to the small heat rise in the cable, the efficient transfer of any heat there is to

the surrounding seawater, and the mixing of the water due to wave and current action. Although the undersea cable is in contact with the seafloor, the thermal resistivity of the sediments or other seafloor material should be substantially higher than that of the seawater. Thus, it can be expected that negligible heat would be transferred directly into the seabed materials. No impact on seafloor or benthic flora or fauna is expected. No impacts on demersal species are expected. Because no measurable increase in the water temperature around the cable is anticipated, no impacts on water quality are expected.

7.2 Equipment Canister

The equipment canister houses the hydraulic motor, generator, and electrical transformer. The heat conduction from the steel canister into surrounding water was calculated using a standard method for calculating heat transfer. The resulting temperature change is approximately 32.0 to 32.2 °F (0.02 to 0.12 °C) for six buoys, assuming quiescent water surrounding the canister.

The heat from the equipment canister would be dissipated quickly and completely by the natural flow of seawater around the canister. Therefore, any temperature rise at the seafloor would be negligible. No impact on the benthic flora or fauna is expected. No impacts on demersal species are expected. No impacts on water quality are expected since there would be no measurable increase in the water temperature around the canister.



DEPARTMENT OF THE NAVY
 PACIFIC DIVISION
 NAVAL FACILITIES ENGINEERING COMMAND
 258 MAKALAPA DR., STE. 100
 PEARL HARBOR, HI 96860-3134

11015.4A8K
 Ser PLN232/ 2063

21 AUG 2002

11015.4A8K
 Ser PLN232/ 2063

Mr. Paul Henson
 U.S. Fish and Wildlife Service
 Pacific Islands Ecoregion
 Box 50088
 Honolulu, Hawaii 96850

Dear Mr. Henson:

The Navy has been working informally with both the National Marine Fisheries Service (NMFS) and your office to assess the possible impacts of the proposed installation and operation of Wave Energy Conversion (WEC) buoys off North Beach at the Marine Corps Base Hawaii (MCBH), Kaneohe Bay, Oahu. A map of the project area is provided as enclosure (1). Mr. Michael Molina and Mr. Antonio Bentivoglio of your staff have represented the Fish and Wildlife Service (FWS) at meetings and discussions regarding the project.

Specific to Section 7 of the Endangered Species Act, the Navy seeks your concurrence with our determination that the project is not likely to adversely affect any listed species under FWS jurisdiction. We have reached this conclusion based on the following:

1. The threatened green sea turtle (*Chelonia mydas*) is found in the waters where the buoys are to be installed. We are coordinating our analysis of possible impacts to listed sea turtles and to listed marine mammals that may be found in the marine environment with NMFS. The green sea turtle is the only listed species of plant or animal under FWS jurisdiction that is found in the project area. No project-related action is scheduled in any designated or proposed critical habitat.
2. While green sea turtles may occasionally haul up on the sandy beaches at MCBH Kaneohe Bay for nesting attempts or basking, these occurrences are not common.
3. The on-shore activities of the project will include one or two days of installation of a cable approximately 2.5 inches in diameter connecting the submerged generators to the existing electrical grid at MCBH. The cable will not be buried, and will be routed to avoid sandy beach areas that may be used by turtles. The cable will not run parallel to the water's edge in such a manner that it might impede or otherwise affect any turtles coming ashore or prevent any hatching turtles, should they appear, from reaching the sea.
4. Where the cable exits the water, it will land on a rock revetment composed of boulders, rocks, and rubble. We believe this does not provide any suitable basking or nesting habitat for the turtles. A photograph of the site where the cable will make its landing is provided as

enclosure (2). Enclosure (3) contains additional photos of the general area where the cable will exit the water and head inland.

5. Onshore construction will consist of anchoring the cable to the ground and installing a 2-foot by 4-foot preformed concrete junction box (vault) to facilitate connecting the undersea cable to the land cable. This vault will be placed well inland and will not impact sea turtles in any way.

6. In the unlikely event that a turtle should come within 30 meters of any cable laying activity on land, operations at the immediate worksite will be modified so as not to adversely affect the animal. As stated previously, cable installation is scheduled to take no more than a few days, depending on weather and sea conditions at the project site. Effects that may be expected should a turtle come too close to the action may include cessation of basking activity and the animal returning to the water. Similarly, shore activities may discourage the turtles from coming ashore at the project site for those brief periods, but North Beach is sufficiently wide to accommodate any turtle that feels compelled to come ashore. Cable installation will be done only during normal daylight hours, and there should be no effect on nocturnal turtle activities.

Thank you for considering this request for concurrence with our determination that the action is not likely to adversely affect any listed species under FWS jurisdiction. If you wish, you may signify your concurrence with our determination by signing on the line below and returning this letter. Should you have any questions or comments, please contact the undersigned at (808) 471-9338.

Sincerely,

 MELVIN N. KAKU

Director
 Environmental Planning Division

We concur with the determination that the project, as described in this letter, will not adversely affect any listed species under the jurisdiction of the U.S. Fish and Wildlife Service.

 Name and Title

 Date

Encl: (see next page)

11015.4A&K
Ser PLN232/2063

- Encl:
- (1) Project Location Map
 - (2) Location of Beach Anchor
 - (3) Four Images of the Shoreline at the Project Site.

Copy to:
Pacific Islands Area Office
National Marine Fisheries Service
1601 Kapiolani Boulevard, Suite 1110
Honolulu, Hawaii 96814-4700

State of Hawaii
Department of Land and Natural Resources
Division of Aquatic Resources
1151 Punchbowl Street
Honolulu, Hawaii 96813

Blind copy to:
NFESC (ESC427)
MCBH Kaneohe Bay (LE)

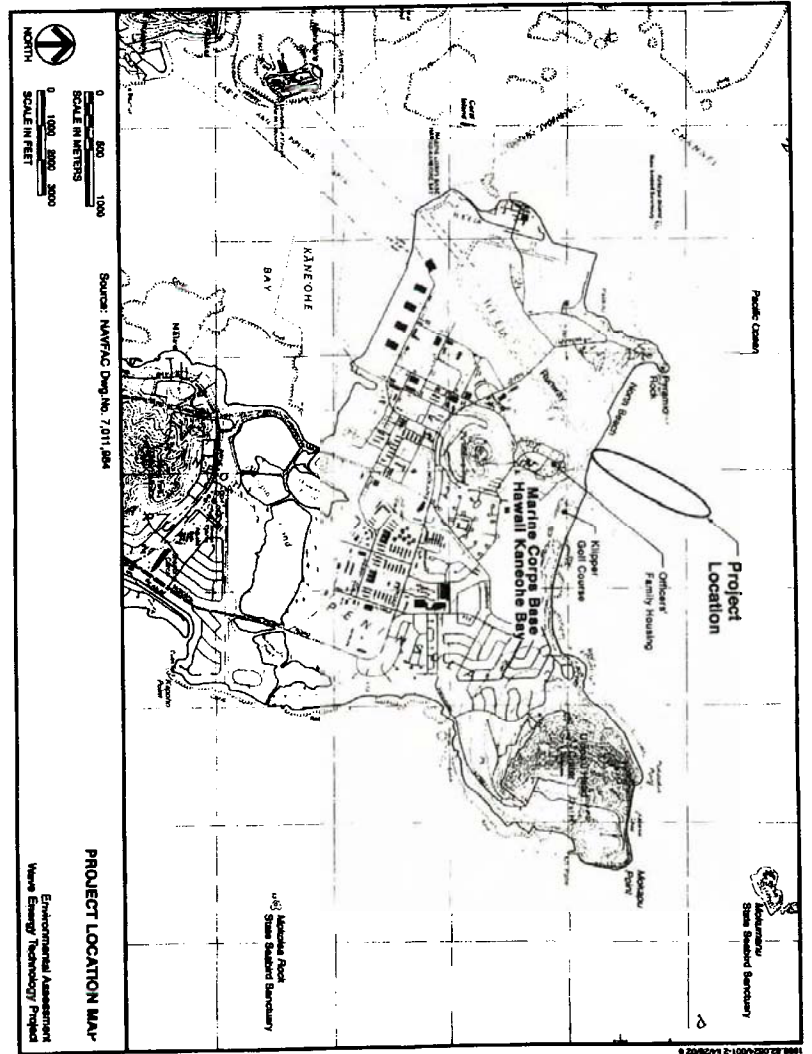

Enclosure (1)



Cable Shore Anchor

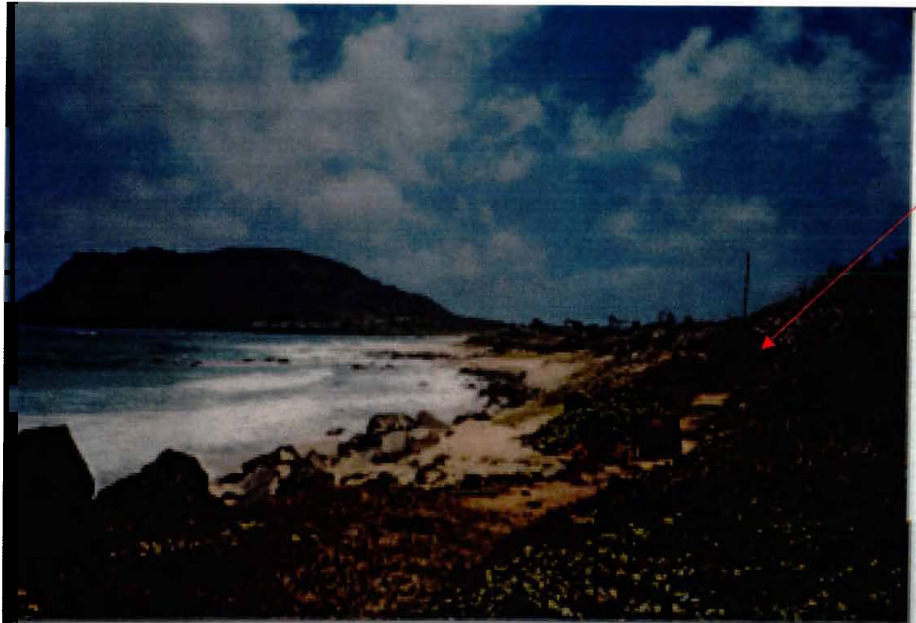

Cable will be anchored using rock bolts in the natural basalt

Figure 2. Location of Cable Beach Anchor



UNITED STATES DEPARTMENT OF COMMERCE
National Oceanic and Atmospheric Administration
NATIONAL MARINE FISHERIES SERVICE
Southwest Region / Pacific Islands Area Office
1601 Kapiolani Boulevard, Suite 1110
Honolulu, Hawaii 96814-0047

October 16, 2002

Melvin N. Kaku, Director
Environmental Planning Division
Department of the Navy
Pacific Division
Naval Facilities Engineering Command
258 Makalapa Dr., Ste. 100
Pearl Harbor, HI 96860-3134

RE: Request for informal section 7, Endangered Species Act, consultation regarding wave energy conversion project at Marine Corps Base Hawaii, Kaneohe Bay, Hawaii.

Dear Mr. Kaku:

This responds to your request for informal section 7, Endangered Species Act, consultation regarding the wave energy conversion project at Marine Corps Base Hawaii (MCBH), Kaneohe Bay, Hawaii. We provide the following comments and information under our statutory authorities under the Endangered Species Act of 1973, as amended (16 U.S.C. 1531 *et seq.*).

The National Marine Fisheries Service (NOAA Fisheries) concurs with your determination that the proposed phased installation and testing of up to six Wave Energy Conversion buoys off North Beach at MCBH is not likely to adversely affect endangered and threatened species under our jurisdiction. NOAA Fisheries recommends incorporating a monitoring plan to periodically examine the inside of the buoys for any indication of sea turtle or other protected species interaction. Any indication of a protected species interaction should be reported to NOAA Fisheries, Pacific Islands Area Office, 1601 Kapiolani Blvd., Suite 1110, Honolulu, Hawaii 96814, (808) 973-2937.

Should the project plans change or additional information become available, this determination may be reconsidered. Should you have further questions regarding our comments for the proposed project and/or the section 7 process, please contact Margaret Akamine or David Nichols at (808) 973-2937 or fax (808) 973-2941.

Sincerely,

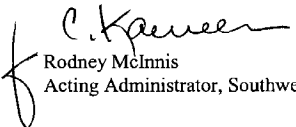
Rodney McInnis
Acting Administrator, Southwest Region

cc: Leona Stevenson





United States Department of the Interior

FISH AND WILDLIFE SERVICE
Pacific Islands Fish and Wildlife Office
300 Ala Moana Boulevard, Room 3-122
Box 50088
Honolulu, Hawaii 96850

OCT 22 2002

In Reply Refer to: I-2-2002-I-116

Melvin Kaku
Director, Environmental Planning
Department of the Navy
258 Makalapa Dr., STE. 100
Pearl Harbor, HI 96860-3134

Re: Installation and Operation of Wave Energy Conversion Buoys off North Beach at the Marine Corps Base Hawaii, Kaneohe Bay, Oahu

Dear Mr. Kaku:

The U.S. Fish and Wildlife Service (Service) has received your letter dated August 21, 2002, requesting our concurrence under section 7 of the Endangered Species Act of 1973, as amended (ESA), that the proposed installation and operation of Wave Energy Conversion (WEC) buoys off North Beach at the Marine Corps Base Hawaii (MCBH), Kaneohe Bay, Oahu, will not adversely affect listed species under Service jurisdiction. The threatened green sea turtle (*Chelonia mydas*) is the only listed species under Service jurisdiction that is found in the project area.

The on-shore activities of the proposed project involve one or two days of installation of a cable approximately 2.5 inches in diameter connecting the submerged generators to the existing electrical grid at MCBH. The cable will not be buried, but will be routed to avoid sandy beach areas that may be used by turtles. Where the cable exits the water, it will land on a rock revetment composed of boulders, rocks, and rubble. The cable will not run parallel to the water's edge in such a manner that it might impede or otherwise affect any turtles coming ashore. On-shore construction will consist of anchoring the cable to the ground and installing a two-foot by four-foot preformed concrete junction box to facilitate connecting the undersea cable to the land cable. The vault will be placed inland and will not impact turtles in any way. In the event that a turtle should come within 30 meters of any cable laying activity on land, operations at the

Melvin Kaku

2

immediate worksite will be modified so the turtle is not adversely affected. Based on the information provided in your letter, our involvement in the project, and information from our files, the Service concurs with your determination that the proposed project is not likely to adversely affect any listed species under Service jurisdiction.

The Service has been involved during the planning phase of this project and have viewed both terrestrial and marine resources (using SCUBA). This has enabled all involved to gain a better understanding of the existing coral reef resources and discuss options to locate the project to avoid and minimize impacting coral reef resources as described in Executive Order 13089 on Coral Reef Protection. The Service looks forward to continued coordination on this project and review of National Environmental Policy Act documentation once completed.

We apologize for the delay in responding to your request, but appreciate the opportunity to comment on the proposed project. If you have any questions or comments, please contact Fish and Wildlife Biologist Elizabeth Sharpe by telephone at (808) 541-3441 or by facsimile transmission at (808) 541-3470.

Sincerely,

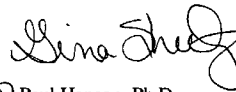
Paul Henson, Ph.D.
Field Supervisor

Appendix A-5

NHPA Section 106 Correspondence
for the Proposed Action



DEPARTMENT OF THE NAVY
 PACIFIC DIVISION
 NAVAL FACILITIES ENGINEERING COMMAND
 258 MAKALAPA DR., STE. 100
 PEARL HARBOR, HI 96860-3134

5750.2M2
 Ser PLN233/ 1958

5750.2M2
 Ser PLN233/ 1958

CERTIFIED MAIL

12 AUG 2002

Mr. Gilbert S. Coloma-Agaran
 State Historic Preservation Officer
 Kakuhihewa Building, Room 555
 601 Kamokila Blvd.
 Kapolei, HI 96707

Dear Mr. Coloma-Agaran:

Pacific Division, Naval Facilities Engineering Command (PACNAVFACENGCOM), in coordination with the Naval Facilities Engineering Service Center (NFESC), and in consultation with the Marine Corps Base Hawaii (MCBH), Kaneohe Bay, is preparing an Environmental Assessment for a Wave Energy Technology (WET) test project proposed by the Office of Naval Research (ONR), for installation at North Beach, MCBH Kaneohe Bay (Enclosure (1) Figures 1 and 2). In accordance with 36 CFR Part 800.3(b), PACNAVFACENGCOM is conducting Section 106 consultation in coordination with the National Environmental Policy Act (NEPA) process.

PROJECT DESCRIPTION

The proposed action is the phased offshore installation and operational testing of up to six wave energy conversion (WEC) buoys over a period of approximately two to five years. Enclosure (1) contains photographs, maps, sketches and specifications of the conceptual plan, and area of potential effect (APE), which are summarized here. Installation of the first two buoys and associated energy conversion equipment canister to which all buoys will be attached, and land-based operation support facilities are tentatively scheduled for the end of the calendar year. The system is programmed for removal five years after the installation of the first buoy.

The buoys and equipment canister will be anchored offshore in approximately 100 ft (30M) of water. The armored and shield undersea power cable and data cable, which weighs about 5.5 pounds per foot submerged and 7.5 pounds per foot on land, will transmit high voltage electrical power from the bouys to a land-based, standard, prefabricated concrete electrical vault where it will transition to a lighter weight land power cable and data cable. From the cable vault, the land power and data cables will be incased in a 4 inch diameter PVC conduit and routed to Building 614, Battery French, where the on-shore electrical power and control equipment will be housed. From the Battery, the power cable will be routed to the electrical grid system using existing underground ducts and manholes.

A rubber-wheeled rough terrain crane will be used to offset the vault on a gravel pad approximately 6 in. thick. A pick-up truck will be used to deliver the gravel to the vault site (Enclosure (1) Figures 11, 12, 13), and a rubber wheeled backhoe loader will be used to distribute and level the gravel. No other ground preparation is planned for the project.

Subsequent to leveling the gravel and offsetting the vault, the crane and backhoe loader will travel the existing dirt roadway to the staging site (Enclosure (1), Figures 10 and 12). The

proposed staging site is next to the proposed landing point for the cable, which is adjacent to the northeast corner of the shoreline revetment constructed for the taxiway. The staging site is a small, relatively level terrace comprised of 2-foot thick fill material overlying ancient coastal dunes, and is situated between the rocky coastline and an on-shore basalt rock formation. Once the crane and backhoe loader are situated to support lifting of the heavy undersea cable to the on-shore anchor, the heavy equipment will be stationary. A grouted rock bolt, 18-24 inch long and 1-3/8 inch in diameter, will be drilled into the basalt rock formation to provide an anchor for the land-end of the undersea power cable.

Along the cable route from the cable vault to the Battery, concrete pedestals (2 ft. X 2 ft.) will be placed at 10-ft intervals and fixed to the ground using rock bolts no larger than 5/8 in. diameter and 12 in. long. The conduit will be jacketed with gravel and a metal ramp will protect the conduit where it crosses the existing dirt road. There will be no ground disturbance or use of heavy equipment during installation of the land cable.

The Battery French will serve as the shore-based equipment shelter. It will contain the on-shore electrical power and control equipment comprised of a computer, transformer, alternate current/direct current (AC/DC) and DC/DC converters, capacitor bank, battery bank and an inverter. Power will be transmitted to the system grid via a power cable, which will be installed in existing underground duct banks. Modifications to the Battery are expected to be minimal and limited to the inside of the structure. The existing air conditioner ducts and the compressor will be replaced with smaller units. The land cable will enter the Battery on the west through an existing wire mesh screen and doorway, and mounted on the length of the main interior corridor wall to exit the existing doorway on the east end (Enclosure (1) Figures 7 and 8). From a selected location in the corridor, the cable will enter the space where the shore-based equipment will be installed. When the cable exits the building, it will run above ground to an existing manhole.

AREA OF POTENTIAL EFFECT

The area of potential effect (APE) extends from the shoreline where the undersea cable is brought on-land, over the adjacent staging area and existing dirt roadway to an area adjacent to the taxiway (Enclosure 2). The APE includes the proposed location for the cable vault, which is a relatively flat space adjacent to the east side of dirt roadway. The APE then follows the route of the cable to Battery French and to the manhole where the cable will eventually tap into the existing electrical grid.

IDENTIFICATION OF HISTORIC PROPERTIES

The Mokapu Burial Area (Site 50-80-11-1017) (MBA) is a subsurface archaeological site containing ancient burials and funerary items of religious and cultural significance to Native Hawaiians (Schiliz 1996; Tuggle and Hommon 1986) listed on the National Register of Historic Places (NRHP). Under the criteria of evaluation in 36 CFR Part 60.4, the MBA is significant under criterion (a) for its pattern of repeated traditional Hawaiian activities, and criterion (d) for the information that it has yielded and is likely to yield in the future that is important to the prehistory of the Mokapu Peninsula specifically and Hawaii in general. The horizontal boundary of the site as designated on the NRHP is situated on North Beach in a coastal dune setting that extends approximately from Pyramid Rock to the west and Ulupa'u Crater to the east. The site

has no visible structural elements. The depth is unknown, but in the past natural erosion has exposed humans remains, and burials have been encountered as deep as 6 meters (19.68 feet). Projects involving excavation and ground-penetrating radar technologies, and historic data, however, have identified certain loci within and beyond the NRHP boundary that are either known, or are likely to contain archaeological deposits, and boundary revisions have been suggested (Prishmont 2000; Williams and Patolo 1998).

The location of the proposed action is in a noncontributing portion of land that is within the NRHP boundary of the Mokapu Burial Area site, although it is outside the revised boundary proposed by Williams and Patolo (1998), and touches the west end of an area suggested by Prishmont (2000) (Enclosure (3) to have low to moderate potential to have human burials. The dunes in the area that Prishmont suspects have potential for human burials are deep and covered by fill. The project area that falls within the arbitrary boundary of the Mokapu Burial Area is capped with fill material about 2 feet (61.5 cm) deep composed of sand mixed with basalt gravel, pebbles, cobbles and boulders that have become cemented, creating a firm ground surface with an overlying thin layer (3/4" - 2 1/3" [2-6 cm]) of loose sand (Enclosure (4). The fill is thought to be associated with construction of the runway and revetment. Boulders characterize the shoreline.

For the purposes of Section 106 for this undertaking, Battery 301 Forrest J. French (Site 50-80-11-1432), a concrete subterranean structure built into the ground and covered with earth during World War II, is considered eligible for the NRHP. It is significant under criterion (a) for its indirect association to the December 7, 1941, attack and possibly (c) because it represents a distinctive architectural type (Schilz et al 1996). Six-inch guns were mounted on two turrets exposed above surface. During the late 1960's and early 1970's, the interior of Battery French was modified to provide offices for the Naval Ocean Systems Center Laboratory. The Battery is currently not used, and the modified interior has deteriorated. The basic structure and turret foundation remain intact (Tuggle and Hommon 1986).

DETERMINATION OF EFFECT

In accordance with 36 CFR Part 800.4(d)(1), PACNAVFACENGCOM, in consultation with the U.S. Marine Corps Kaneohe Bay, finds that although there are historic properties present, the proposed undertaking will have no effect on either the Mokapu Burial Area or Battery French that would alter the characteristics of either property qualifying it for inclusion in or eligibility for the National Register.

While the land-based segment of the project includes action within the Mokapu Burial Area, the project is situated in an area capped by 2 feet (61 cm) of firm fill, and action is designed to exclude excavation and minimize ground disturbance by heavy equipment. Heavy equipment will ingress to the project area using the taxiway and an existing dirt roadway in an area capped by fill. Movement of the equipment will be limited to offsetting the vault box with the crane, and staging the equipment near the ingress of the sea cable to the shore, for emergency support.

The proposed modifications for the Battery French will affect only the interior of the structure, which has been previously modified. Existing openings will be used to run the cable into west doorway and out the east doorway of the Battery. The integrity of the existing concrete structure that holds the possibly distinctive architectural features will not be altered. The cable that will

transmit power to the electrical grid system will be installed in an existing underground duct system, with no potential to affect previously unknown subsurface cultural resources.

In accordance with 36 CFR Part 800.4(d) (1), notifications have been sent to the consulting parties (listed below) known to attach religious and cultural significance to the MBA. Notification has also been sent to the Historic Hawaii Foundation. Should you know of any other organizations or individuals that would like to review this project please contact us.

Mr. A. Van Horn Diamond
Ka Lahui Hawaii
Mrs. Kinau Boyd Kamalii
Kekumano Ohana
Ko'olauloa Hawaiian Civic Club
Mr. Carlos Manuel
Mr. Sam Monet
Hui Malama I Na Kupuna o Hawai'i Nei
Oahu Island Burial Council
Office of Hawaiian Affairs

Mrs. Nalani Olds
Ms. Delilah Ortiz
Ms. Ella Paguyo
Paoa-Kea-Lono Ohana
Prince Kuhio Hawaiian Civic Club
Princess Nahaolele 'O Kamehameha Society
Ms. Terrilee Napua Keko'olani Raymond
Temple of Lono
Ms. Miriam V. Yardley

If you have any comments or questions concerning this project we respectfully request that you provide them within 30 days of receipt of this letter. If no comments are received within 30 days, we will assume you have no objections to the finding of "no historic properties affected". Our point of contact for this project is Ms. Jeannette Simons at 808-474-4886, by facsimile at 808-474-5909, or by email at SimonsJA@cdfpac.navfac.navy.mil.

Sincerely,

MELVIN N. KAKU
Director
Environmental Planning

Encl:

- (1) Project Description
- (2) Aerial photos of area of potential effect
- (3) 1998 Proposed revised boundary and 2002 Area suggested to have low to moderate potential for human burials
- (4) Photo of Beach Cut

References Cited

2002 Commander, Navy Region Hawaii, Pearl Harbor, Hawaii

Integrated Cultural Resources Management Plan. Prepared by Helbert Hastert Fee, Planners under contract with Pacific Division, Naval Facilities Engineering Command

2000 Prishmont, Laura

Archaeological Subsurface Testing In Conjunction with the Airfield Runway Repairs Project (ARRP) in the Mokapu Burial Area Marine Corps Base Hawaii Kaneohe Bay, Oahu, Hawaii. Prepared for Department of the Navy, Pacific Division, Naval Facilities Engineering Command, Pacific Division, Pearl Harbor, HI.

1996 Schilz, Allan J., Richard L. Carrico, Ann Yoklavich, Robert P. Drolet, Patricia Drolet, Richard Nees, James Landrum

Cultural Resources Management Plan Marine Corps Base Hawaii Kaneohe Bay, Island of O`ahu, Hawaii. Prepared for Department of the Navy, Pacific Division, Naval Facilities Engineering Command, Pacific Division, Pearl Harbor, HI.

1986 Tuggle, H. David and Robert J. Hommon

Historic Property Inventory, Marine Corps Air Station, Kaneohe Bay: History, Survey, and Site Descriptions. U.S. Naval Facilities Engineering Command, Pacific Division, Pearl Harbor.

1998 Williams, Scott S. and Patolo

Subsurface Survey and Boundary Delimitation of the Mokapu Burial Area, Marine Corps Base Hawaii Kaneohe Bay, Oahu, Hawaii. Submitted to U.S. Naval Facilities Engineering command, Pacific Division, Pearl Harbor

1 In addition to the preceding Section 106 correspondence with the Hawaii State Historic
2 Preservation Officer (SHPO), PACNAVFACENGCOM also consulted with the Native Hawaiian
3 organizations and individuals listed below.

- 4 • Mr. A. Van Horn Diamond
- 5 • Ka Lahui Hawaii
- 6 • Mrs. Kinau Boyd Kamalii
- 7 • Kekumano Ohana
- 8 • Ko'olauloa Hawaiian Civic Club
- 9 • Mr. Carlos Manuel
- 10 • Mr. Sam Monet
- 11 • Hui Malama I Na Kupuna o Hawai'i Nei
- 12 • Oahu Island Burial Council
- 13 • Office of Hawaiian Affairs
- 14 • Mrs. Nalani Olds
- 15 • Ms. Delilah Ortiz
- 16 • Ms. Ella Paguyo
- 17 • Paoa-Kea-Lono Ohana
- 18 • Prince Kuhio Hawaiian Civic Club
- 19 • Princess Nahoa Olelo 'O Kamehameha Society
- 20 • Ms. Terrilee Napua Keko'olani Raymond
- 21 • Temple of Lono
- 22 • Ms. Miriam V. Yardley



STATE OF HAWAII

DEPARTMENT OF LAND AND NATURAL RESOURCES

HISTORIC PRESERVATION DIVISION
KAKU-IHEWA BUILDING, ROOM 558
801 KAMOKILA BOULEVARD
KAPOLEI, HAWAII 96707

NE
GILBERT S. COLOMA-AGARAN, CHAIRPERSON
BOARD OF LAND AND NATURAL RESOURCES
COMMISSION ON WATER RESOURCES MANAGEMENT

DEPUTIES
ERIC T. HIRANO
LIMNEL NISHIOKA

AQUATIC RESOURCES
BOATING AND OCEAN RECREATION
COMMISSION ON WATER RESOURCE
MANAGEMENT
CONSERVATION AND RESOURCES
ENFORCEMENT
CONVEYANCES
FORESTRY AND WILDLIFE
HISTORIC PRESERVATION
LAND
STATE PARKS

October 1, 2002

Melvin N. Kaku, Director
Environmental Planning Division
Department of the Navy
Naval Facilities Engineering Command
258 Makalapa Dr., Ste. 100
Pearl Harbor, HI 96860-3134

LOG NO: 30773 ✓
DOC NO: 0209EJ17

Dear Mr. Kaku:

**SUBJECT: National Historic Preservation Act Section 106 Review – Environmental Assessment Preparation for a Wave Energy Technology Test Project at North Beach, MCBH, Kaneohe Bay Kane`ohe, Ko`olaupoko, O`ahu
TMK: (1) 4-4-008:001**

Thank you for the opportunity to comment on the proposed undertaking for the offshore installation and operational testing of wave energy conversion buoys. This project includes installation of buoys and associated land based operations. Our review is based on historic reports, maps, and aerial photographs maintained at the State Historic Preservation Division; no field inspection was made of the project areas. We received notification of this undertaking from your office on August 14, 2002, and apologize for the delay in our response, but we have been working with your staff and members of the O`ahu Island Burial Council's (OIBC) Section 106 Subcommittee to resolve some differences. Subsequent email communication with your staff and the OIBC's Section 106 Subcommittee has clarified several aspects of the undertaking, and we can now provide comment. We appreciate your patience and consideration of the OIBC's concerns.

The project involves anchoring buoys and equipment canisters and cable offshore and transition to land based power and data cables routed to Building 614, Battery French. Ground preparation at the proposed land site for the cable includes installation of a 6-in thick gravel pad for a crane and backhoe loader used to lift the undersea cable to the shore. No ground disturbance or heavy equipment will be used to install the land portion of the cable which will be routed as indicated in a recent electronic transmission from your office (Message from Jeannette Simons at efdpac.navfac.navy.mil on 09/26/2002 at 09:05 AM, SUBJECT: RE: 106

Melvin N. Kaku, Director
Page Two

Consultation/Wave Energy Technology MCBH Battery French). In addition, 2 ft by 2 ft. concrete pedestals will be placed along the land route and bolted to the ground with one-inch diameter rock bolts to a maximum depth of three feet, as indicated in the same electronic transmission from your office. Battery French will contain the on-shore electrical power and control equipment. Modifications to the Battery are limited to the inside of the structure. The land cable will enter the Battery through an existing wire mesh screen and doorway and be mounted on the main interior wall to the existing doorway on the east end. Upon exiting the Battery the land cable will run above ground to an existing manhole.

The Navy has determined that although there are historic properties present, Battery French and the Mokapu Burial Area, the proposed undertaking will not alter the characteristics qualifying these properties for inclusion in or eligibility for the National Register. The project is situated within the Mokapu Burial Area where it has been determined that there is a low to moderate potential of containing human burials. Archaeologists from the Navy and the Marine Corps have walked the area and probed the route for the above ground conduit. The area is capped by 2 feet of fill which is thought to be associated with the construction of the runway and revetment. The undertaking has also been designed to minimize ground disturbance within the APE by heavy equipment and excavation as well as placement of the lightweight pedestals for the above ground conduits. Alteration to Battery French is limited to the interior of the structure, which has been previously modified. Based on the information provided in both your original notification and subsequent electronic messages, we concur with your "no historic properties affected" determination.

Should you have any questions about archaeology, please feel free to call Sara Collins at 692-8026 or Elaine Jourdane at 692-8027. Should you have any questions about burial matters, please feel free to contact Kai Markell 587-0008.

Aloha,

Gilbert Coloma-Agaran
State Historic Preservation Officer

EJ:jk

c: Mr. A. Van Horn Diamond, Chair, O`ahu Island Burial Council
Mr. Kai Markell, Burial Sites Program



DEPARTMENT OF THE NAVY
 PACIFIC DIVISION
 NAVAL FACILITIES ENGINEERING COMMAND
 258 MAKALAPA DR., STE. 100
 PEARL HARBOR, HI 96860-3134

5090P.1F13B
 Ser PLN231/ 128

5090P.1F13B
 Ser PLN231/ 128

16 JAN 2003

Blind copy to:
 NFESC (Code ESC 52)
 NFESC (Code ESC 427)
 09C
 BOS1624

Ms. Jalna Keala, Acting Director
 Hawaiian Rights Division
 Hawaii State Office of Hawaiian Affairs
 711 Kapiolani Blvd., Suite 500
 Honolulu, HI 96813

Subj: WAVE ENERGY TECHNOLOGY (WET) TEST PROJECT AT
 MARINE CORPS BASE HAWAII (MCBH) KANEOHE BAY

Dear Ms. Keala:

Thank you for commenting on our letter of August 12, 2002 and the overall project identified above. This responds to your letter of August 20, 2002, which stated that the Office of Hawaiian Affairs would rely on the assurances of the project proponent that proper consultation and mitigation will be done in accordance with applicable Federal and state laws in the event that any unanticipated or unidentified cultural sites were encountered during project development. We would like to assure you that this requirement has been addressed in the WET Environmental Assessment document and is being included in the Best Management Practices for the project. We believe the mechanism for preventing accidental loss of heritage and artifacts has been put in place.

We appreciate your efforts to raise this important concern.

Should you have any questions, please contact Mr. Gary Kasaoka (PLN231GK) at 471-9338.

Sincerely,

MELVIN N. KAKU
 Director
 Environmental Planning Division

Copy to:
 ONR (Code 334)
 NAVREGHI (N465)
 MCBH (LE)

PHONE (808) 594-1888



STATE OF HAWAII
OFFICE OF HAWAIIAN AFFAIRS
711 KAPUOLANI BOULEVARD, SUITE 500
HONOLULU, HAWAII 96813

FAX (808) 594-1865



DEPARTMENT OF THE NAVY
PACIFIC DIVISION
NAVAL FACILITIES ENGINEERING COMMAND
258 MAKALAPA DR., STE. 100
PEARL HARBOR, HI 96860-3134

5090P.1E13B
Ser PLN231/ 129

16 JAN 2003

August 20, 2002

HRD02/713

Mr. Melvin Kaku
Director, Environmental Planning
Department of the Navy
Pacific Division
Naval Facilities Engineering Command
258 Makalapa Drive, Suite 100
Pearl Harbor, HI 96860-3134

Dear Mr. Kaku:

Subject: Wave Energy Technology Project, MCBH Hawaii, Kaneohe, Oahu

This letter is provided as a response to the materials of August 12, 2002, requesting review relating to the above document and findings. OHA offers the following comments relating to the undertaking. Although the situation for development appears benign in terms of adverse effects to cultural resources of concern to Native Hawaiians, we will rely on the assurances of the proponent of the project that they will engage in proper consultation and mitigation in accordance with federal and state law (as appropriate) should any unanticipated or unidentified cultural, historic, or burial sites be encountered during project development.

Thank you for the opportunity to review and comment relating the proposed project. If you have any questions, please contact Wayne Kawamura, Policy Analyst at 594-1945, or email him at: waynek@oha.org.

Sincerely,

Jalna Keala
Acting Director, Hawaiian Rights Division

JK: wk

cc: BOT
ADM

Ms. Miriam (Toni) V. Yardley
2053 Kula Street
Honolulu, HI 96817

Subj: WAVE ENERGY TECHNOLOGY (WET) TEST PROJECT AT
MARINE CORPS BASE HAWAII (MCBH) KANEOHE BAY

Dear Ms. Yardley:

Thank you for responding to our letter of August 12, 2002 and commenting on the subject project. This responds to your e-mail dated August 29, 2002, which stated that you had no concerns regarding WET, and, in fact, support the technology as a means for energy savings.

You expressed concern as to the proposed location of the project because it falls within the boundary of that part of MCBH Kaneohe Bay known as the Mokapu Burial Area (MBA). You questioned whether the Navy had conducted scoping meetings to consider other areas that would not fall within the MBA boundary. The Navy did in fact consider other locations both statewide and on Oahu at which to site the project. In addition, other parts of MCBH were considered for placing the project, but it was concluded that North Beach, where the action is proposed, has the best conditions for conducting the tests for this project.

Every effort has been made to avoid adversely impacting cultural items that may exist in the MBA as a result of siting the project at North Beach. This was thoroughly described in the Navy's Section 106 consultation letter to the State Historic Preservation Office (SHPO), which was followed by your comment on the proposed action. In a letter dated October 1, 2002, the SHPO concurred with our determination that there would be "no historic properties affected," as a result of the WET proposed action. More importantly, we want you to know that prior to construction, all workers at the site will be made aware of the possibility of encountering unanticipated cultural items, including requisite procedures to follow should such discoveries occur.

5090P.1E13B
Ser PLN231/ 129

Again, we thank you for participating in this endeavor.

Should you have any questions, please contact Mr. Gary Kasaoka (PLN231GK) at 471-9338.

Sincerely,



MELVIN N. KAKU
Director
Environmental Planning Division

Copy to:
ONR (Code 334)
NAVREGHI (N465)
MCBH (LE)

Blind copy to:
NFESC (Code ESC 52)
NFESC (Code ESC 427)
09C
BOS1624

From: Simons, Jeannette A (EFDPA)
Sent: Thursday, August 29, 2002 1:42 PM
To: 'Toni Auld Yardley'
Subject: RE: Wave Energy Technology

RECEIVED

Jeannette Simons
Archaeologist PLN233
PACNAVFACENGCOM
Ph: DSN 471-9338/474-4886
Fax: DSN 474-5909
Email: SimonsJA@efdpac.navfac.navy.mil

-----Original Message-----

From: Toni Auld Yardley [mailto:HawaiianNews@hawaii.rr.com]
Sent: Thursday, August 29, 2002 12:37 PM
To: Simons, Jeannette A (EFDPA)
Subject: Re: Wave Energy Technology

August 27, 2002

Aloha Ms. Jeanette Simons,

I just received the letter from Melvin kaku dated August 12, 2002 today re:Wave Energy Technology Project, due to a change of address. My current address is 2053 Kula Street, Honolulu, Hawaii 96817.

I have no concerns regarding the technology, in fact I support it as an energy savings device.

I do have concerns regarding the location in relation to the already designated culturally significant sites known as the Mokapu Burial Areas.

It took many years to get that area designated to be protected under historical preservation laws and I do not like the precedence being set by the request for an exemption.

Has there been any scoping methods conducted to evaluate other areas that would not be in the known burial areas?? If not, I would request this be done.

Please reply to this email as a confirmation of receiving my statement.

Mahalo nui loa,
Miriam V. Yardley
Phone: (808) 595-4819



DEPARTMENT OF THE NAVY
 PACIFIC DIVISION
 NAVAL FACILITIES ENGINEERING COMMAND
 256 MAKALAPA DR., STE. 100
 PEARL HARBOR, HI 96860-3134

5090P.1F13B
 Ser PLN231/ 54

5090P.1F13B
 Ser PLN231/ 54

9 JAN 2003

Ms. Nalani Olds
 P.O. Box 4673
 Kaneohe, HI 96744

Subj: DRAFT ENVIRONMENTAL ASSESSMENT (EA) FOR WAVE
 ENERGY TECHNOLOGY (WET) TEST PROJECT AT MARINE
 CORPS BASE HAWAII (MCBH) KANEOHE BAY

Dear Ms. Olds:

Thank you for participating in the review of subject document. This responds to your letter dated October 27, 2002, in which you referenced a Navy letter of August 12, 2002 that was prepared for this project under the implementing regulations of Section 106 of the National Historic Preservation Act (NHPA), 36 CFR Part 800. The Hawaii State Historic Preservation Officer (SHPO) subsequently concurred with our determination of "no historic properties affected."

Although the majority of the comments in your letter were unrelated to the potential effect of the project on historic properties, we attempted to provide the information you requested by meeting with you on November 14, 2002 at Zippy's restaurant in Kaneohe. Ms. June Cleghorn represented the Marine Corps, and the Navy was represented by Messrs. Don Rochon and Kendall Kam. Ocean Powers Technologies, Inc. was represented by Mr. Bill Powers, who along with Mr. Kam briefed you on the technological and operational aspects of the WET project. Also present at the meeting were Mr. Van Horn Diamond, Chair, Oahu Island Burial Council, and Mr. Richard (Keke) Papa, who is part of Mr. Diamond's *ohana*.

We briefed the project and went through the list of questions raised in your October 27, 2002 letter, answering them one-by-one. Several handouts, including those that pertained directly to the Wave Energy Converter buoy, were provided, which we hope you found useful and informative. Reiterating the response to your question on the need for an Ethno-Botanist, we stated that although such a specialist would not be on site, qualified biologists have assessed both the submerged and land-based portions of the project looking for possible threatened and endangered (T&E) species that might be impacted by the project, as well as, for native Hawaiian plant species at the land-based part of the project.

Regarding the concern for possible inadvertent discovery of Native Hawaiian human remains in the Mokapu Burial Area, as discussed during the November 14, 2002 meeting, we believe the likelihood of this occurring is very low. Should human remains be

discovered during project implementation, Navy will follow the Native American Graves Protection and Repatriation Act (NAGPRA) regulations that apply.

Regarding your suggestion that project workers be informed of the cultural significance of the Mokapu Burial Area, we appreciate your offer to conduct a briefing on this topic and will contact you to discuss this further and make arrangements. As discussed during the November 14, 2002 meeting, the Navy can accommodate a Hawaiian groundbreaking ceremony prior to construction activities should you or a Native Hawaiian organization wish to conduct one on a voluntary basis, with the condition that the blessing be conducted and coordinated by a non-government entity, subject to reasonable requirements for identification, safety, and other administrative and security procedures.

Should you have any questions, please contact Mr. Gary Kasaoka (PLN231GK) of my staff at 471-9338.

Sincerely,

Melvin N. Kaku
 Director
 Environmental Planning Division

Copy to:
 ONR (Code 334)
 NAVREGHI (N465)
 MCBH (LE)

Blind copy to:
 NFESC (Code ESC 52)
 NFESC (Code ESC 427)
 O9C
 BOS1624

NALANI OLDS
P. O. BOX 4673
KANE'OHE, HI. 96744

October 27, 2002

To whom this may concern:

I am writing this in response to your letter of August 12, 2002, not received by myself due to a change of address, until August 30, 2002. I will address my concerns/questions in the order that they are referred to in each paragraph.

1) As I understand from the "Excerpts from Working Draft Environmental Assessment for Preferred Alternative Prepared by PACNAVFACENGCOM July 2002", the project testing will take place over a period of 2 to 5 years.

What operational data is WEC trying to validate with OPT?

What is their overall goal?

2) The Shore Based Transmission Cable will be secured using concrete pedestals and held with rock bolts.

How long and thick are these bolts?

What type of rock will they be going into?

3) Installation Procedures:

Why would you "store" excess cable between buoy(s) 1 and 2 on the ocean bottom? For how long?

Would you be drilling just for that?

Is there consideration taken concerning high, rough, unforeseen wave and current action?

What would the course of action be should the site chosen turn out to be "not conducive to the expected outcome of the project"?

Would I expect that if the above were the case, moving to another site would not be an option?

4) System Removal:

How long will it take to remove everything?

Is there consideration as to the restoration of the areas under water as well on Land? This means restoration back to the way those areas were found.

5) If this proves to be a "good" project, what are the assurances that this will be the end of it, or will the next "project" be to install a permanent or modified system without notifying anyone? For me, if this project moves forward, it would be just for this one time. No one can even guess as to what the ramifications of this project might be.

6) Culturally I have a few questions.

Is this type or kind of testing being done anywhere else in the world? If so, where, and is the method the same?

Are those other site(s) historically significant to their specific areas? If not, why not and, why Hawai'i in particular?

Is an Ethno-Botanist in the equation from the beginning to the end to assess/protect/restore flora on the ocean bottom and also on land?

Will the MCBH Archaeologist be part of the project "team" to watch for any unforeseen ancient burials?

Why would the installation date of the equipment be chosen during a period of time when the ocean currents and tides are at their highest? Wouldn't it stand to reason that studying the tide charts would be premier to the success of the project. Winter is when the seas are the roughest.

7) One final comment.

I am assuming that all of the "team" who will actually be working on the project, from the beginning to the end, and whenever "new" persons come along, will be trained culturally as to the significance of Mokapu, and all of its surrounding area.

Should you have any comments I can be reached at 808-261-1171 or at the above address.

Me ka Mahalo,

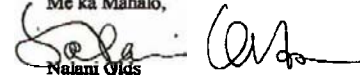
Nalani Olds

Appendix B-1

Copies of Scoping Letters for the
Pearl Harbor Site Alternative



DEPARTMENT OF THE NAVY
 PACIFIC DIVISION
 NAVAL FACILITIES ENGINEERING COMMAND
 258 MAKALAPA DR., STE. 100
 PEARL HARBOR, HI 96860-3134

5090P.1F13B
 Ser PLN231/ 2077

5090P.1F13B
 Ser PLN231/ 2077

22 AUG 2002

Mr. Douglas Tom
 Office of Planning/Coastal Zone Management Program
 Dept of Business, Economic Development and Tourism
 P.O. Box 2359
 Honolulu, HI 96804

Dear Mr. Tom:

In March of this year we informed you by letter that the Office of Naval Research (ONR) and Ocean Power Technologies, Inc. (OPT) proposed to install, in phases, up to six buoys in approximately 100 feet of water off North Beach at Marine Corps Base Hawaii (MCBH), Kaneohe Bay, to conduct a full-scale ocean test of OPT's wave energy converter (WEC) technology. The purpose of the study is to collect data and to demonstrate the technical feasibility of using ocean wave power to produce useful quantities of electricity at military installations. The project also includes the installation of an undersea cable to transmit the generated power to an existing power grid at the base.

The Navy has been preparing an Environmental Assessment (EA) for the installation of the buoys and undersea cable. As part of the scoping process under the National Environmental Policy Act (NEPA), we solicited and subsequently received your comments on the proposed project. We now wish to solicit your comments on the Pearl Harbor alternative to the proposed action at Kaneohe Bay. We have enclosed a number of slides to help you visualize the Pearl Harbor alternative scenario. Enclosure (1) is a vicinity map of the Pearl Harbor Entrance Channel depicting the buoy field and the route of the undersea cable that would extend to the land-based part of the project at Naval Magazine Pearl Harbor, West Loch Branch where monitoring equipment and grid connection would be situated. Enclosures (2) and (3) are drawings of the WEC buoy of which there would be as many as six and the mooring buoys of which there would be as many as four at the perimeter of the buoy field (Enclosure 4), respectively. A schematic drawing of the proposed buoy field is provided as enclosure (5). The wave energy test project will be terminated after a period of five years.

In addition to your earlier comments on the scope of this test project that you provided, the Navy is interested in hearing of any special concerns on the Pearl Harbor alternative you feel should be addressed in the EA.

Please provide your official response to this office by September 13, 2002. To ensure that your input arrives in time to be considered in the project, request that you send an advance copy by facsimile transmission or by e-mail.

Should you have any questions, please contact Mr. Gary Kasaoka (PLN231GK), Navy Environmental Planner, by voice at 471-9338, by facsimile transmission at 474-5909, or via e-mail at: [KasaokaGS@cfdpac.navy.mil](mailto:KasaokaGS@cfdpac.navfac.navy.mil).

Sincerely,

 MELVIN N. KAKU
 Director
 Environmental Planning Division

Encl:

- (1) Pearl Harbor Alternative Vicinity Map
- (2) WEC Buoy, Anchor, & Canister
- (3) Cutaway Buoy Assembly
- (4) Mooring Buoy Drawing
- (5) Proposed Buoy Field

Blind Copy to: (w/o enclosures)
 NFESC (Code ESC 52)
 MCBH Kaneohe Bay (LE)
 BOS162KHK
 ENV1811SB

Belt Collins Hawaii, Ltd.
 Attn: Ms. Judith Charles
 680 Ala Moana Blvd. First Floor
 Honolulu, HI 96813-5406



DEPARTMENT OF THE NAVY
 PACIFIC DIVISION
 NAVAL FACILITIES ENGINEERING COMMAND
 258 MAKALAPA DR., STE. 100
 PEARL HARBOR, HI 96860-3134

5090P.1F13B
 Ser PLN231/ **2080**

5090P.1F13B
 Ser PLN231/ **2080**

22 AUG ~~2002~~

Dr. Charles Kamella
 Administrator, Pacific Islands Area Office
 National Marine Fisheries Service
 1601 Kapiolani Boulevard, Suite 1110
 Honolulu, HI 96814-4700

Dear Dr. Kamella:

In March of this year we informed you by letter that the Office of Naval Research (ONR) and Ocean Power Technologies, Inc. (OPT) proposed to install, in phases, up to six buoys in approximately 100 feet of water off North Beach at Marine Corps Base Hawaii (MCBH), Kaneohe Bay, to conduct a full-scale ocean test of OPT's wave energy converter (WEC) technology. The purpose of the study is to collect data and to demonstrate the technical feasibility of using ocean wave power to produce useful quantities of electricity at military installations. The project also includes the installation of an undersea cable to transmit the generated power to an existing power grid at the base.

The Navy has been preparing an Environmental Assessment (EA) for the installation of the buoys and undersea cable. As part of the scoping process under the National Environmental Policy Act (NEPA), we solicited and subsequently received your comments on the proposed project. We now wish to solicit your comments on the Pearl Harbor alternative to the proposed action at Kaneohe Bay. We have enclosed a number of slides to help you visualize the Pearl Harbor alternative scenario. Enclosure (1) is a vicinity map of the Pearl Harbor Entrance Channel depicting the buoy field and the route of the undersea cable that would extend to the land-based part of the project at Naval Magazine Pearl Harbor, West Loch Branch where monitoring equipment and grid connection would be situated. Enclosures (2) and (3) are drawings of the WEC buoy of which there would be as many as six and the mooring buoys of which there would be as many as four at the perimeter of the buoy field (Enclosure 4), respectively. A schematic drawing of the proposed buoy field is provided as enclosure (5). The wave energy test project will be terminated after a period of five years.

In addition to your earlier comments on the scope of this test project that you provided, the Navy is interested in hearing of any special concerns on the Pearl Harbor alternative you feel should be addressed in the EA.

Please provide your official response to this office by September 13, 2002. To ensure that your input arrives in time to be considered in the project, request that you send an advance copy by facsimile transmission or by e-mail.

Should you have any questions, please contact Mr. Gary Kasaoka (PLN231GK), Navy Environmental Planner, by voice at 471-9338, by facsimile transmission at 474-5909, or via e-mail at: KasaokaGS@efdpac.navy.mil.

Sincerely,

 MELVIN N. KAKU
 Director
 Environmental Planning Division

Encl:

- (1) Pearl Harbor Alternative Vicinity Map
- (2) WEC Buoy, Anchor, & Canister
- (3) Cutaway Buoy Assembly
- (4) Mooring Buoy Drawing
- (5) Proposed Buoy Field

Blind Copy to: (w/o enclosures)
 NFESC (Code ESC 52)
 MCBH Kaneohe Bay (LE)
 BOS162KHK
 ENV1811SB

Belt Collins Hawaii, Ltd.
 Attn: Ms. Judith Charles
 680 Ala Moana Blvd. First Floor
 Honolulu, HI 96813-5406



DEPARTMENT OF THE NAVY
PACIFIC DIVISION
NAVAL FACILITIES ENGINEERING COMMAND
258 MAHALAPA DR. STE. 100
PEARL HARBOR, HI 96860-3134

5090P.1F13B
Ser PLN2317 2078

5090P.1F13B
Ser PLN2317 2078

22 AUG 2002

Mr. Paul Henson
U.S. Fish and Wildlife Service
Pacific Islands Ecoregion
300 Ala Moana Blvd., Room 6307
Honolulu, HI 96813

Dear Mr. Henson:

In March of this year we informed you by letter that the Office of Naval Research (ONR) and Ocean Power Technologies, Inc. (OPT) proposed to install, in phases, up to six buoys in approximately 100 feet of water off North Beach at Marine Corps Base Hawaii (MCBH), Kaneohe Bay, to conduct a full-scale ocean test of OPT's wave energy converter (WEC) technology. The purpose of the study is to collect data and to demonstrate the technical feasibility of using ocean wave power to produce useful quantities of electricity at military installations. The project also includes the installation of an undersea cable to transmit the generated power to an existing power grid at the base.

The Navy has been preparing an Environmental Assessment (EA) for the installation of the buoys and undersea cable. As part of the scoping process under the National Environmental Policy Act (NEPA), we solicited and subsequently received your comments on the proposed project. We now wish to solicit your comments on the Pearl Harbor alternative to the proposed action at Kaneohe Bay. We have enclosed a number of slides to help you visualize the Pearl Harbor alternative scenario. Enclosure (1) is a vicinity map of the Pearl Harbor Entrance Channel depicting the buoy field and the route of the undersea cable that would extend to the land-based part of the project at Naval Magazine Pearl Harbor, West Loch Branch where monitoring equipment and grid connection would be situated. Enclosures (2) and (3) are drawings of the WEC buoy of which there would be as many as six and the mooring buoys of which there would be as many as four at the perimeter of the buoy field (Enclosure 4), respectively. A schematic drawing of the proposed buoy field is provided as enclosure (5). The wave energy test project will be terminated after a period of five years.

In addition to your earlier comments on the scope of this test project that you provided, the Navy is interested in hearing of any special concerns on the Pearl Harbor alternative you feel should be addressed in the EA.

Please provide your official response to this office by September 13, 2002. To ensure that your input arrives in time to be considered in the project, request that you send an advance copy by facsimile transmission or by e-mail.

Should you have any questions, please contact Mr. Gary Kasaoka (PLN231GK), Navy Environmental Planner, by voice at 471-9338, by facsimile transmission at 474-5909, or via e-mail at: KasaokaGS@efdpac.navy.mil.

Sincerely,

MELVIN N. KAKU
Director
Environmental Planning Division

Encl:

- (1) Pearl Harbor Alternative Vicinity Map
- (2) WEC Buoy, Anchor, & Canister
- (3) Cutaway Buoy Assembly
- (4) Mooring Buoy Drawing
- (5) Proposed Buoy Field

Blind Copy to: (w/o enclosures)
NFESC (Code ESC 52)
MCBH Kaneohe Bay (LE)
BOS162KHK
ENV1811SB

Belt Collins Hawaii, Ltd.
Attn: Ms. Judith Charles
680 Ala Moana Blvd. First Floor
Honolulu, HI 96813-5406



DEPARTMENT OF THE NAVY
 PACIFIC DIVISION
 NAVAL FACILITIES ENGINEERING COMMAND
 258 MAKALAPA DR., STE. 100
 PEARL HARBOR, HI 96860-3134

5090P.1F13B
 Ser PLN231/ **2079**

5090P.1F13B
 Ser PLN231/ **2079**

22 AUG 2002

Mr. William Devick
 Division of Aquatic Resources
 Department of Land and Natural Resources
 1151 Punchbowl Street, Room 330
 Honolulu, HI 96813

Should you have any questions, please contact Mr. Gary Kasaoka (PLN231GK), Navy Environmental Planner, by voice at 471-9338, by facsimile transmission at 474-5909, or via e-mail at: KasaokaGS@efdpac.navy.mil.

Sincerely,

 MELVIN N. KAKU
 Director
 Environmental Planning Division

Dear Mr. Devick:

Encl:

In March of this year we informed you by letter that the Office of Naval Research (ONR) and Ocean Power Technologies, Inc. (OPT) proposed to install, in phases, up to six buoys in approximately 100 feet of water off North Beach at Marine Corps Base Hawaii (MCBH), Kaneohe Bay, to conduct a full-scale ocean test of OPT's wave energy converter (WEC) technology. The purpose of the study is to collect data and to demonstrate the technical feasibility of using ocean wave power to produce useful quantities of electricity at military installations. The project also includes the installation of an undersea cable to transmit the generated power to an existing power grid at the base.

- (1) Pearl Harbor Alternative Vicinity Map
- (2) WEC Buoy, Anchor, & Canister
- (3) Cutaway Buoy Assembly
- (4) Mooring Buoy Drawing
- (5) Proposed Buoy Field

The Navy has been preparing an Environmental Assessment (EA) for the installation of the buoys and undersea cable. As part of the scoping process under the National Environmental Policy Act (NEPA), we solicited and subsequently received your comments on the proposed project. We now wish to solicit your comments on the Pearl Harbor alternative to the proposed action at Kaneohe Bay. We have enclosed a number of slides to help you visualize the Pearl Harbor alternative scenario. Enclosure (1) is a vicinity map of the Pearl Harbor Entrance Channel depicting the buoy field and the route of the undersea cable that would extend to the land-based part of the project at Naval Magazine Pearl Harbor, West Loch Branch where monitoring equipment and grid connection would be situated. Enclosures (2) and (3) are drawings of the WEC buoy of which there would be as many as six and the mooring buoys of which there would be as many as four at the perimeter of the buoy field (Enclosure 4), respectively. A schematic drawing of the proposed buoy field is provided as enclosure (5). The wave energy test project will be terminated after a period of five years.

Blind Copy to: (w/o enclosures)
 NFESC (Code ESC 52)
 MCBH Kaneohe Bay (LE)
 BOS162KHK
 ENV1811SB

Belt Collins Hawaii, Ltd.
 Attn: Ms. Judith Charles
 680 Ala Moana Blvd. First Floor
 Honolulu, HI 96813-5406

In addition to your earlier comments on the scope of this test project that you provided, the Navy is interested in hearing of any special concerns on the Pearl Harbor alternative you feel should be addressed in the EA.

Please provide your official response to this office by September 13, 2002. To ensure that your input arrives in time to be considered in the project, request that you send an advance copy by facsimile transmission or by e-mail.



DEPARTMENT OF THE NAVY
PACIFIC DIVISION
NAVAL FACILITIES ENGINEERING COMMAND
258 MAKALAPA DR., STE. 100
PEARL HARBOR, HI 96860-3134

5090P.1F13B
Ser PLN231/ 2083

5090P.1F13B
Ser PLN231/ 2083
22 AUG 2002

From: Commander, Pacific Division, Naval Facilities Engineering Command
To: Commander, U.S. Army Corps of Engineers District, Honolulu (CEPOH-EC-R)
Fort Shafter, HI 96858-5440

Subj: WAVE ENERGY TECHNOLOGY (WET) TEST PROJECT AT MCBH
KANEHOE BAY, HAWAII - SCOPING THE THIRD ALTERNATIVE

Encl: (1) Pearl Harbor Alternative Vicinity Map
(2) WEC Buoy, Anchor, & Canister
(3) Cutaway Buoy Assembly
(4) Mooring Buoy Drawing
(5) Proposed Buoy Field

1. In March of this year we informed you by letter that the Office of Naval Research (ONR) and Ocean Power Technologies, Inc. (OPT) proposed to install, in phases, up to six buoys in approximately 100 feet of water off North Beach at Marine Corps Base Hawaii (MCBH), Kaneohe Bay, to conduct a full-scale ocean test of OPT's wave energy converter (WEC) technology. The purpose of the study is to collect data and to demonstrate the technical feasibility of using ocean wave power to produce useful quantities of electricity at military installations. The project also includes the installation of an undersea cable to transmit the generated power to an existing power grid at the base.

2. The Navy has been preparing an Environmental Assessment (EA) for the installation of the buoys and undersea cable. As part of the scoping process under the National Environmental Policy Act (NEPA), we solicited and subsequently received your comments on the proposed project. We now wish to solicit your comments on the Pearl Harbor alternative to the proposed action at Kaneohe Bay. We have enclosed a number of slides to help you visualize the Pearl Harbor alternative scenario. Enclosure (1) is a vicinity map of the Pearl Harbor Entrance Channel depicting the buoy field and the route of the undersea cable that would extend to the land-based part of the project at Naval Magazine Pearl Harbor, West Loch Branch where monitoring equipment and grid connection would be situated. Enclosures (2) and (3) are drawings of the WEC buoy of which there would be as many as six and the mooring buoys of which there would be as many as four at the perimeter of the buoy field (Enclosure 4), respectively. A schematic drawing of the proposed buoy field is provided as enclosure (5). The wave energy test project will be terminated after a period of five years.

3. In addition to your earlier comments on the scope of this test project that you provided, the Navy is interested in hearing of any special concerns on the Pearl Harbor alternative you feel should be addressed in the EA.

4. Please provide your official response to this office by September 13, 2002. To ensure that your input arrives in time to be considered in the project, request that you send an advance copy by facsimile transmission or by e-mail.

5. Should you have any questions, please contact Mr. Gary Kasaoka (PLN231GK), Navy Environmental Planner, by voice at 471-9338, by facsimile transmission at 474-5909, or via e-mail at: KasaokaGS@efdpac.navy.mil.

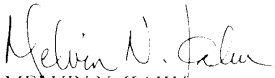
MELVIN N. KAKU
By direction

Blind Copy to: (w/o enclosures)
NFESC (Code ESC 52)
MCBH Kaneohe Bay (LE)
BOS162KHK
ENV1811SB

Belt Collins Hawaii, Ltd.
Attn: Ms. Judith Charles
680 Ala Moana Blvd. First Floor
Honolulu, HI 96813-5406



DEPARTMENT OF THE NAVY
PACIFIC DIVISION
NAVAL FACILITIES ENGINEERING COMMAND
258 MAKALAPA DR., STE. 100
PEARL HARBOR, HI 96860-3134

5090P.1F13B
Ser PLN231/ 2082

22 AUG 2002

From: Commander, Pacific Division, Naval Facilities Engineering Command
To: Commander, U.S. Coast Guard, 14th Coast Guard District, 300 Ala Moana Blvd.,
Honolulu, HI 96850

Subj: WAVE ENERGY TECHNOLOGY (WET) TEST PROJECT AT MCBH
KANEHOHE BAY, HAWAII - SCOPING THE THIRD ALTERNATIVE

Encl: (1) Pearl Harbor Alternative Vicinity Map
(2) WEC Buoy, Anchor, & Canister
(3) Cutaway Buoy Assembly
(4) Mooring Buoy Drawing
(5) Proposed Buoy Field

1. In March of this year we informed you by letter that the Office of Naval Research (ONR) and Ocean Power Technologies, Inc. (OPT) proposed to install, in phases, up to six buoys in approximately 100 feet of water off North Beach at Marine Corps Base Hawaii (MCBH), Kaneohe Bay, to conduct a full-scale ocean test of OPT's wave energy converter (WEC) technology. The purpose of the study is to collect data and to demonstrate the technical feasibility of using ocean wave power to produce useful quantities of electricity at military installations. The project also includes the installation of an undersea cable to transmit the generated power to an existing power grid at the base.

2. The Navy has been preparing an Environmental Assessment (EA) for the installation of the buoys and undersea cable. As part of the scoping process under the National Environmental Policy Act (NEPA), we solicited and subsequently received your comments on the proposed project. We now wish to solicit your comments on the Pearl Harbor alternative to the proposed action at Kaneohe Bay. We have enclosed a number of slides to help you visualize the Pearl Harbor alternative scenario. Enclosure (1) is a vicinity map of the Pearl Harbor Entrance Channel depicting the buoy field and the route of the undersea cable that would extend to the land-based part of the project at Naval Magazine Pearl Harbor, West Loch Branch where monitoring equipment and grid connection would be situated. Enclosures (2) and (3) are drawings of the WEC buoy of which there would be as many as six and the mooring buoys of which there would be as many as four at the perimeter of the buoy field (Enclosure 4), respectively. A schematic drawing of the proposed buoy field is provided as enclosure (5). The wave energy test project will be terminated after a period of five years.

5090P.1F13B
Ser PLN231/ 2082

3. In addition to your earlier comments on the scope of this test project that you provided, the Navy is interested in hearing of any special concerns on the Pearl Harbor alternative you feel should be addressed in the EA.

4. Please provide your official response to this office by September 13, 2002. To ensure that your input arrives in time to be considered in the project, request that you send an advance copy by facsimile transmission or by e-mail.

5. Should you have any questions, please contact Mr. Gary Kasaoka (PLN231GK), Navy Environmental Planner, by voice at 471-9338, by facsimile transmission at 474-5909, or via e-mail at: KasaokaGS@efdpac.navy.mil.

MELVIN N. KAKU
By direction

Blind Copy to: (w/o enclosures)
NFESC (Code ESC 52)
MCBH Kaneohe Bay (LE)
BOS162KHK
ENV1811SB

Belt Collins Hawaii, Ltd.
Attn: Ms. Judith Charles
680 Ala Moana Blvd. First Floor
Honolulu, HI 96813-5406



DEPARTMENT OF THE NAVY
PACIFIC DIVISION
NAVAL FACILITIES ENGINEERING COMMAND
258 MAKALAPA DR., STE. 100
PEARL HARBOR, HI 96860-3134

5090P.1F13B
Ser PLN231/ 2081

22 AUG 2002

From: Commander, Pacific Division, Naval Facilities Engineering Command
To: Officer in Charge, 15 CES CEVP, Hickam AFB

Subj: WAVE ENERGY TECHNOLOGY (WET) TEST PROJECT AT MCBH
KANEHOE BAY, HAWAII – SCOPING THE THIRD ALTERNATIVE

Encl: (1) General Description/Operation of WEC Buoy
(2) Installation Site Plan at MCBH
(3) WET Test Project, MCBH Kaneohe Bay
(4) Pearl Harbor Alternative Vicinity Map
(5) WEC Buoy, Anchor, & Canister
(6) Cutaway Buoy Assembly
(7) Mooring Buoy Drawing
(8) Proposed Buoy Field

1. In March of this year, a scoping letter was distributed to various stakeholders announcing that the Office of Naval Research (ONR) and Ocean Power Technologies, Inc. (OPT) proposed to install, in phases, up to six buoys in approximately 100 feet of water off North Beach at Marine Corps Base Hawaii (MCBH), Kaneohe Bay. Enclosures (1) through (3) accompanied the first scoping letter and is provided to give you background information.

2. The proponent of the project will conduct a full-scale ocean test of OPT's wave energy converter (WEC) technology for collecting data in order to demonstrate the technical feasibility of using ocean wave power to produce useful quantities of electricity at military installations. The project would include the installation of an undersea cable to transmit the generated power to an existing power grid at the base.

3. The Navy has been preparing an Environmental Assessment (EA) for the installation of the buoys and undersea cable at MCBH. As part of the original scoping effort under the National Environmental Policy Act (NEPA), we solicited and subsequently received comments from a number of government agencies on the proposed project. We now wish to solicit your comments on the Pearl Harbor alternative to the proposed action at Kaneohe Bay. We have enclosed a number of slides to help you visualize the Pearl Harbor alternative scenario. Enclosure (4) is a vicinity map of the Pearl Harbor Entrance Channel depicting the proposed buoy field and the route of the undersea cable that would extend to the land-based part of the project at Naval Magazine Pearl Harbor, West Loch Branch where monitoring equipment and grid connection would be situated. Enclosures (5) and (6) are drawings of the WEC buoy of which there would be as many as six and the mooring buoys of which there would be as many as four at the perimeter of the buoy

5090P.1F13B
Ser PLN231/ 2081

field (Enclosure 7), respectively. A schematic drawing of the proposed buoy field is provided as enclosure (8). The wave energy test project will be terminated after a period of five years.

4. We are interested in hearing of any special concerns on the Pearl Harbor alternative that you feel should be addressed in the EA.

5. Please provide your official response to this office by September 13, 2002. To ensure that your input arrives in time to be considered in the project, request that you send an advance copy by facsimile transmission or by e-mail to the individual named below.

6. Should you have any questions, please contact Mr. Gary Kasaoka (PLN231GK), Navy Environmental Planner, by voice at 471-9338, by facsimile transmission at 474-5909, or via e-mail at: KasaokaGS@efdpac.navfac.navy.mil.

MELVIN N. KAKU
By direction

Blind Copy to: (w/o enclosures)
NFESC (Code ESC 52)
MCBH Kaneohe Bay (LE)
BOS162KHK
ENV1811SB

Belt Collins Hawaii, Ltd.
Attn: Ms. Judith Charles
680 Ala Moana Blvd. First Floor
Honolulu, HI 96813-5406

Appendix B-2

Agency Responses for the Pearl Harbor Site Alternative

APPENDIX B-2

Scoping letters for the Pearl Harbor Site alternative were sent to the following agencies in August 2002. The Navy is awaiting responses from these agencies and will incorporate those responses as necessary in subsequent versions of this document:

- Department of Business, Economic Development and Tourism, State Office of Planning
- National Marine Fisheries Service
- U.S. Fish and Wildlife Service
- Division of Aquatic Resources, Department of Land and Natural Resources, State of Hawaii
- U.S. Army Corps of Engineers
- U.S. Coast Guard
- Hickam AFB



**DEPARTMENT OF BUSINESS,
ECONOMIC DEVELOPMENT & TOURISM**

OFFICE OF PLANNING

235 South Beretania Street, 6th Floor, Honolulu, Hawaii 96813
Mailing Address: P.O. Box 2359, Honolulu, Hawaii 96804

BENJAMIN J. CAYETANO
GOVERNOR
SEIJI F. NAYA, Ph.D.
DIRECTOR
SHARON S. NAKIMATSU
DEPUTY DIRECTOR
DAVID W. BLANE
DIRECTOR OF PLANNING

Telephone: (808) 587 2846
Fax: (808) 587 2821

SEP-13-2002 12:19

Aquatic Resources

008 587 0115 P.01/02

BENJAMIN J. CAYETANO
GOVERNOR OF HAWAII



STATE OF HAWAII
DEPARTMENT OF LAND AND NATURAL RESOURCES
DIVISION OF AQUATIC RESOURCES
1151 PUNCHBOWL STREET
HONOLULU, HAWAII 96813

GILBERT S. COLOMA-AGARAN
CHAIRPERSON
BOARD OF LAND AND NATURAL RESOURCES

DEPUTY DIRECTOR
ERIC T. HIRANO

DEPUTY DIRECTOR
FOR THE COMMISSION ON
WATER RESOURCES MANAGEMENT
LUREL T. HESKKA

AQUATIC RESOURCES
BOATING AND OCEAN RECREATION
COMMISSION ON WATER RESOURCES
MANAGEMENT
CONSERVATION AND RESOURCES
ENFORCEMENT
CONVEYANCES
FORESTRY AND WILDLIFE
HISTORIC PRESERVATION
KAHOOLAWE ISLAND RESERVE
COMMISSION
LAND
STATE PARKS

Ref No. P-9796

August 27, 2002

Mr. Melvin N. Kaku, Director
Environmental Planning Division
Naval Facilities Engineering Command
Department of the Navy
258 Makalapa Drive, Suite 100
Pearl Harbor, Hawaii 96860-3134

Dear Mr. Kaku:

Subject: Office of Naval Research and Ocean Power Technologies, Inc. (OPT) Proposal to
Conduct an Ocean Test of OPT's Wave Energy Converter Technology

This is in response to your request for comments dated August 22, 2002, on the proposed project to conduct a full-scale ocean test of the OPT's wave energy converter technology. The proposal includes the installation of under sea cables, mooring buoys, and up to six converters. The buoy field and undersea cables will be within the Pearl Harbor Entrance Channel and extend to the Naval Magazine Pearl Harbor, West Loch Branch on the Island of Oahu.

In compliance with the Coastal Zone Management Act Federal Consistency Regulations a federal consistency determination or a negative determination should be submitted to our office for the proposed Department of the Navy project.

Should you have any questions, please call Debra Tom of our CZM Program at 587-2840.

Sincerely,

David W. Blane, AICP
Director
Office of Planning

cc: U.S. Army Corps of Engineers, Regulatory Branch
U.S. Environmental Protection Agency
U.S. Fish and Wildlife Service, Pacific Islands Ecoregion
U.S. National Marine Fisheries Service, Pacific Area Office
Department of Health, Clean Water Branch
Department of Land & Natural Resources Management
Planning & Technical Service Branch
State Historic Preservation Division
City and County of Honolulu, Department of Planning and Permitting

9/12/02

Melvin Kaku, Director, Environmental Planning Division
Department of the Navy, Pacific Division
Naval Facilities Engineering Command
258 Makalapa Dr., Ste. 100
Pearl Harbor, HI 96860-3134

Mr. Kaku:

Thank you for the opportunity to provide additional requested comments on the Pearl Harbor Alternative for the Wave Energy Conversion Project which would propose to install up to six buoys in approximately 120 feet of water off the western side of the Pearl Harbor Ship Channel, adjacent to "Tripod Reef". We have a number of preliminary concerns regarding the proposed project which are outlined below.

1. Pearl Harbor is known to contain a wide variety of alien organisms not currently found outside of the harbor entrance. The information provided does not currently deal with concerns regarding proposed project research, construction or military efforts which might inadvertently facilitate the spread of these alien species outside of the areas in which they already occur. Our agency would welcome the opportunity to work directly with you to develop protocols to prevent such an occurrence if this project is to move forward at this location.
2. The figure of the proposed cable route on the western side of the ship channel (Enclosure 1) appears to site the cable from the buoy locations shoreward and place such cable alongside the base of the reef slope. At this stage we have only limited information regarding the ecological make-up of this reef slope, but presumably live corals may exist there and therefore would be a concern that needs to be dealt with if this alternative moves forward. Additional concerns regard the ecological impact of siting cable into crevices alongside the reef slope which may serve as primary fish & invertebrate recruitment sites for this location. We would need to conduct a site visit with our biologists to determine if this is a real concern and how it might effect the marine natural resources in the area (Similar concerns exist regarding the mooring locations for the monitoring dive boat (Enclosure 5)).
3. No information is provided regarding the length of each of the three anchoring chains or area of the gravity base for this location. Given that six of these buoys are proposed, each being roughly 49 feet long and 13 feet wide, we are concerned regarding the footprint that each of these anchoring systems will have on bottom habitat near the channel entrance. Additionally, the Enclosure 1 figure suggests that this area has a relatively steep slope which goes from less than 12 meters to roughly 42 m within a short distance; would the anchoring systems need to extend into these shallow and deeper depths?

4. Recent data from the NWHI and American Samoa suggests that large pieces of metal left atop coral reef habitats for extended periods of time may result in facilitating the growth and expansion of cyanobacteria or blue-green algae (*Lyngby* spp.). Given the suggested relatively large size of the anchoring systems ~~and the length of the~~ experiment (five years), there may be concerns regarding such an event occurring with this proposed research. As such, established coral colonies both atop the reef flat and slope at "Tripod Reef" and the nearby "Ahua Reef" may be at risk.
5. As the Pearl Harbor location appears to call for the placement of the Buoy-to-Shore cables along the reef slope, what mechanisms would be employed to prevent lateral movement as a result of high wave energy? Such lateral movement would have a "bulldozing effect" on sessile benthic marine organisms.
6. What types of monitoring are proposed for this project? Specifically, how will biological impacts be monitored and what protocols are proposed to minimize such impacts?

If you have any questions, please call Mr. David Gulko at (808) 587-0318. Thank you for the opportunity to provide comments on this matter.

Sincerely,

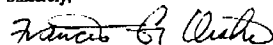
 William S. Devick, Administrator
 Division of Aquatic Resources

Cc: Francis Oishi, DAR
 Dave Gulko, DAR
 Richard Sixberry, DAR
 Gary Kasaoka, Planner, USN



REPLY TO
 ATTENTION OF

DEPARTMENT OF THE ARMY
 U. S. ARMY ENGINEER DISTRICT, HONOLULU
 FT. SHAFTER, HAWAII 96850-5440

CEPOH-EC-R (1145b)

28 August 2002

MEMORANDUM FOR MR. GARY KASAOKA (PLN231GK), PACIFIC
 DIVISION, NAVAL FACILITIES ENGINEERING COMMAND, 258 MAKALAPA
 DRIVE, STE 100, PEARL HARBOR, HAWAII 96860-3134

SUBJECT: Wave Energy Technology (WET) Test Project at MCBH
 Kaneohe Bay, Hawaii--Scoping the Third Alternative

1. Reference your memorandum, 5090P 1F13B ser PLN231/2083, subject as above, dated 22 August 2002.
2. A Department of the Army (DA) permit will be required for the buoy field and work boat moorings near the Pearl Harbor entrance channel.
3. Point of Contact for this action is Mr. William Lennan, CEPOH-EC-R at 438-6986 or FAX 438-4060. File No. 200200515.

 GEORGE P. YOUNG, P.E.
 Chief, Regulatory Branch



Commander
Fourteenth Coast Guard District

300 Ala Moana Blvd., 9th Floor
Honolulu, HI 96850-4982
Staff Symbol: (oan)
Phone: (808) 541-2320
FAX: (808) 541-2309

5090P.1F13B
August 30, 2002

MEMORANDUM

From: *M.C. Cosenza*
M. C. Cosenza
Commander (oan), 14th Coast Guard District

Reply to LT McBrady
Attn of: 541-2319

To: Commander, Pacific Division,
Naval Facilities Engineering Command

SUBJ: WAVE ENERGY TECHNOLOGY (WET) TEST PROJECT AT MCBH KANEOHE BAY, HAWAII – SCOPING THE THIRD ALTERNATIVE

Ref: (a) E-mail between LT Papuga CGD14(dpl) and Mr. Kasaoka PACDIV NAVFACENCOM of 22 Mar 02

1. In response to your request for comments on the Pearl Harbor alternative to the WET Test Project proposed for MCBH, Kaneohe Bay, and in addition to the comments in reference (a), I submit the following input:

(a) Having two 15'x 40' steel structures permanently attached to the seafloor, along with a four point, unlighted workboat mooring configuration, all located within 500 feet of Pearl Harbor Entrance Channel Lighted Buoy 1 is navigationally risky. The area around the Pearl Harbor entrance channel is heavily trafficked by a wide variety of military, commercial and recreational vessels, many of which would suffer significant damage as a result of an allision with one of these structures. The intent of the Pearl Harbor Entrance Range and Channel is to guide vessels safely in and out of Pearl Harbor. Placing the much larger, lighted WET structures immediately adjacent to the entrance of this lateral aid system would unnecessarily confuse the existing navigation system, and could increase the frequency of marine accidents.

(b) Lighted Buoy 1 has an average Buoy Station Dimension (a circle of likely positions based on mooring length, water depth and exactly where the mooring is positioned) of about 40 yards and the ships that service the aid are 225 feet in length, leaving a maximum of only about 150 feet between the ship and your array, and then only if the aid is placed and floating directly over its assigned position, which is statistically very unlikely. More problematic is the fact that the aid is generally set to the west of its assigned position and CG buoy tenders service the aid by approaching it from the west into the prevailing wind and current. Therefore, the proposed WET project site would markedly restrict the ability of CG buoy tenders to safely approach and service Lighted Buoy 1. Should a buoy tender experience any type of propulsion or weight handling gear casualty while approaching, servicing or departing Lighted Buoy 1, the chances of alliding with a WET structure and severely damaging it and/or the cutter are unfortunately quite good.

SUBJ: WAVE ENERGY TECHNOLOGY (WET) TEST PROJECT 5090P.1F13B
AT MCBH KANEOHE BAY, HAWAII – SCOPING THE 30 Aug 02
THIRD ALTERNATIVE

Additionally, the last time Lighted Buoy 1 was reported off station was 1987. Although that is encouraging, given the depth gradient in that area, an easterly wind combined with large ocean swells has the potential to easily move Lighted Buoy 1 into deeper water where its mooring would then be susceptible to further dragging and fouling on the WET structure(s).

2. The aforementioned reasons lead me to recommend against locating the WET project in close proximity to the Pearl Harbor Entrance Channel. If a site near Pearl Harbor is desired, a more acceptable location not less than 1500 feet west and shoreward of the entrance channel would sufficiently mitigate the concerns detailed above.

3. I appreciate the opportunity to comment on this project and look forward to working with you to ensure its future success as well as the continued success of the Pearl Harbor and Marine Corps Base, Hawaii waterway systems. If you desire further comment or clarification please contact LT Mike McBrady at the above phone number or email mtmcb Brady@d14.uscg.mil.

#

Copy: CGC WAINUI (WETB-205)

Appendix B-3

CZMA Negative Determination Notice for the Pearl Harbor Site Alternative



DEPARTMENT OF THE NAVY
 PACIFIC DIVISION
 NAVAL FACILITIES ENGINEERING COMMAND
 258 MAKALAPA DR., STE. 100
 PEARL HARBOR, HI 96860-3134

5090P.1F13B
 Ser PLN231/2234

3 SEP 2002

5090P.1F13B
 Ser PLN231/2234

Mr. David W. Blane, AICP, Director
 Hawaii Office of Planning
 Department of Business, Economic Development & Tourism
 P.O. Box 2359
 Honolulu, HI 96804

Dear Mr. Blane:

Subject: Coastal Zone Management Act (CZMA) Negative Determination Notice
 Pearl Harbor Alternative Site, Office of Naval Research and Ocean Power
 Technologies, Inc. (OPT) Proposal to Conduct an Ocean Test of OPT's
 Wave Energy Converter (WEC) Technology

Pacific Division, Naval Facilities Engineering Command (PACNAVFACENGCOM), on behalf of its client, the Office of Naval Research (ONR), and the host activity, MCBH Kaneohe Bay, wishes to inform you that a consistency determination is not required (i.e., negative determination) under the CZMA for the Pearl Harbor alternative of the project. The project site at Pearl Harbor is shown on enclosure (1).

In an earlier negative determination letter to you dated May 24, 2002, we discussed ONR's proposal to install and operate as many as six WEC buoys off North Beach, MCBH Kaneohe Bay. As previously discussed, the primary purpose of the project is to test the equipment under actual sea conditions and to collect empirical data on technology performance for a total period of five years.

In response to your letter dated August 27, 2002 (DBEDT-OP Ref. No. P-9796), the Navy has determined that a consistency determination for the Pearl Harbor alternative is not required because the proposed action will not have reasonably foreseeable direct and indirect effects on any coastal use or resource of the State's coastal zone and there will be no spillover effect.

Please contact Mr. Gary Kasaoka (PLN231GK) at 471-9338 should you have any questions.

Sincerely,

Melvin N. Falar
 Environmental Planning Division

Encl. (see next page)

Encl:
 (1) Pearl Harbor Alternative Location Map

Copy to:
 Office of Naval Research (Code 334)
 800 N. Quincy Street
 Arlington, VA 22217-5660

Naval Facilities Engineering Service Center
 Ocean Engineering Department (Code ESC 52)
 1100 23rd Avenue
 Port Hueneme, CA 90043

MCBH Kaneohe Bay
 I & L Directorate (Code LE)
 Kaneohe Bay, HI 96863-3002

Belt Collins Hawaii Ltd.
 2153 North King Street, Suite 200
 Honolulu, HI 96819

Blind copy to: (w/o encls)
 BOS 1624
 ENV1811SB
 09C

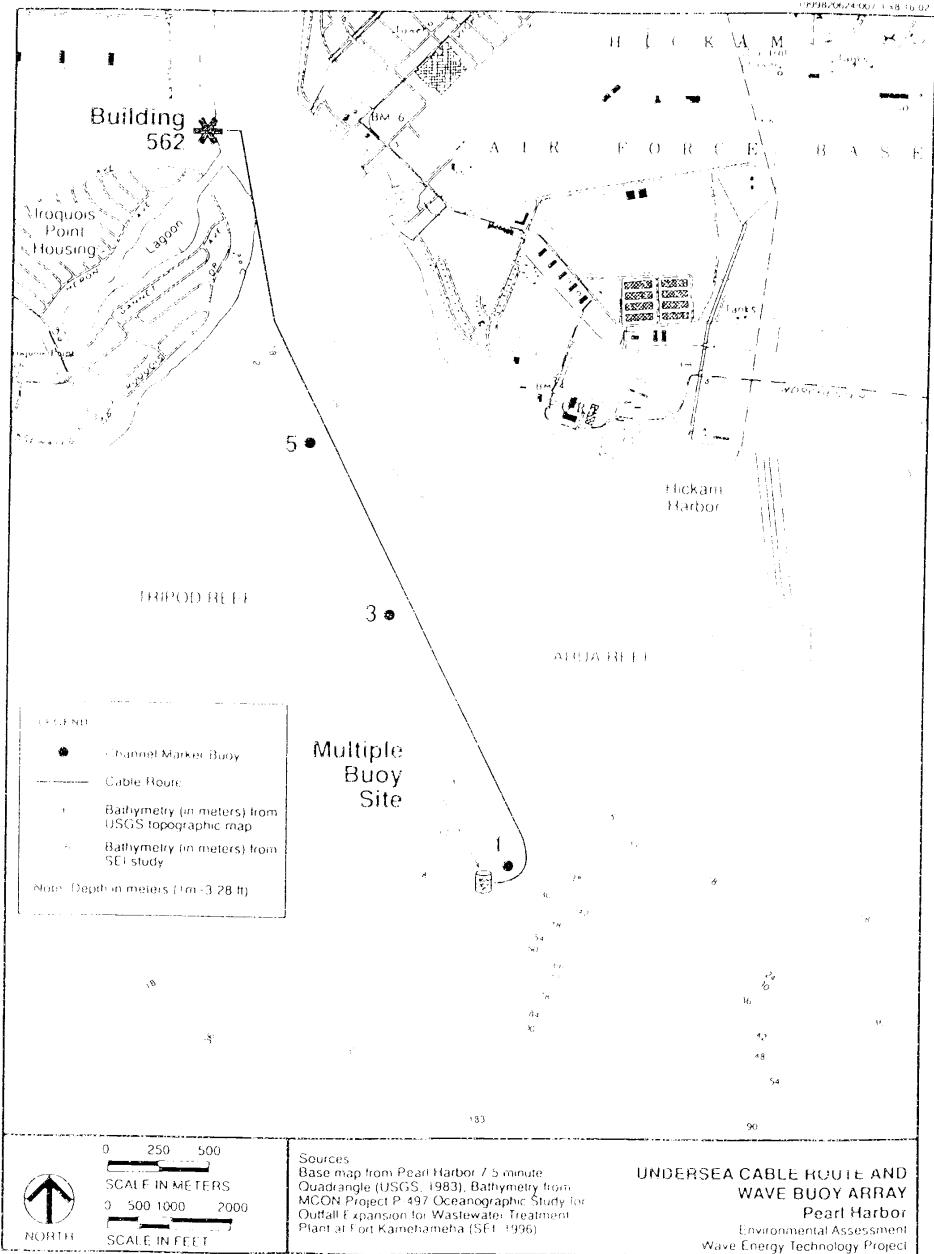

ENCLOSURE (/)

Appendix C

Navy Responses to Agency Comments on the Draft EA



DEPARTMENT OF THE NAVY
PACIFIC DIVISION
NAVAL FACILITIES ENGINEERING COMMAND
258 MAKALAPA DR., STE. 100
PEARL HARBOR, HI 96860-3134

5090P.1F13B
Ser PLN231/ 52

9 JAN 2003

5090P.1F13B
Ser PLN231/ 52

Mr. Gilbert Coloma-Agaran
Historic Preservation Division
Hawaii Department of Land and Natural Resources
Kakuhihewa Building, Room 555
601 Kamokila Boulevard
Kapolei, HI 96707

Blind copy to:
NFESC (Code ESC 52)
NFESC (Code ESC 427)
09C
BOS1624

Subj: AGENCY REVIEW OF DRAFT ENVIRONMENTAL ASSESSMENT
(EA) FOR WAVE ENERGY TECHNOLOGY (WET) TEST PROJECT
AT MARINE CORPS BASE HAWAII (MCBH) KANEOHE BAY

Dear Mr. Coloma-Agaran:

Thank you for your review of the subject document. This responds to your letter (LOG NO. 30925, DOC NO. 0210EJ07) dated October 18, 2002 in which you indicated that your comments relating to the Section 106 consultation under the National Historic Preservation Act (NHPA) for the project was not included in the subject document. As you correctly surmised, the letter in question had not arrived in time to be included in the Draft EA. But please be assured that the Section 106 consultation letter with your comments has been included in the document as an important and integral part of the Final EA for this project.

Should you have any questions regarding the EA, please contact Mr. Gary Kasaoka (PLN231GK) at 471-9338.

Sincerely,

MELVIN N. KAKU
Director
Environmental Planning Division

Copy to:
ONR (Code 334)
NAVREGHI (N465)
MCBH (LE)



STATE OF HAWAII

DEPARTMENT OF LAND AND NATURAL RESOURCES

HISTORIC PRESERVATION DIVISION
KAKUHIWEWA BUILDING, ROOM 556
801 KAMOLELA BOULEVARD
KAPOLEI, HAWAII 96707

GILBERT S. COLOMA-AGARAN, CHAIRPERSON
BOARD OF LAND AND NATURAL RESOURCES
COMMISSION ON WATER RESOURCES MANAGEMENT

DEPUTIES
ERIC T. HIRANO
LIMNEL HISHOKA

AQUATIC RESOURCES
BOATING AND OCEAN RECREATION
COMMISSION ON WATER RESOURCE
MANAGEMENT
CONSERVATION AND RESOURCES
ENFORCEMENT
CONVEYANCES
FORESTRY AND WILDLIFE
HISTORIC PRESERVATION
LAND
STATE PARKS



DEPARTMENT OF THE NAVY
PACIFIC DIVISION
NAVAL FACILITIES ENGINEERING COMMAND
258 MAKALAPA DR., STE. 100
PEARL HARBOR, HI 96860-3134

5090P.1F13B
Ser PLN231/ 51

9 JAN 2003

October 18, 2002

Melvin N. Kaku, Director
Environmental Planning Division
Department of the Navy, Pacific Division
Naval Facilities Engineering Command
258 Makalapa Dr., Ste. 100
Pearl Harbor, Hawaii 96860-3134

LOG NO: 30925 ✓
DOC NO: 0210EJ07

Dear Mr. Kaku:

SUBJECT: National Historic Preservation Act Section 106 Review – Draft Environmental Assessment (DEA) for Proposed Wave Energy Technology (WET) Project at Marine Corps Base Hawaii, Kaneohe Bay, Hawaii
Kane`ohe, Ko`olaupoko, O`ahu
TMK: (1) 4-4-008-001

Paul Henson, Ph.D., Field Supervisor
U.S. Fish and Wildlife Service
Pacific Islands Fish and Wildlife Office
300 Ala Moana Boulevard, Room 3-122
Box 50088
Honolulu, HI 96850

Subj: AGENCY REVIEW OF DRAFT ENVIRONMENTAL ASSESSMENT (EA) FOR WAVE ENERGY TECHNOLOGY (WET) TEST PROJECT AT MARINE CORPS BASE HAWAII (MCBH) Kaneohe Bay

Dear Dr. Henson:

Thank you for participating in the agency review of subject document. This responds to your November 4, 2002 letter referenced as PI-03-09.

Thank you for the opportunity to review the Draft copy of the EA for the proposed Wave Energy Technology (WET) Project at MCBH, Kaneohe Bay, Hawaii. We received the DEA from your office on October 4, 2002, and provide the following comments.

We provided the Navy with our comments on this project during the EA preparation phase. Our previous comments, which concurred with your "no historic properties affected" determination, were based on several discussions with your staff and the Section 106 Subcommittee of the Oahu Island Burial Council (SHPD Log 30773, October 1, 2002). It appears however, that our comments were not included in the DEA because of our delay in responding to you during the preparation phase. We apologize for our previous delay and expect that our comments will be included in the Final EA for this project.

Should you have any questions please about archaeology, please feel free to call Sara Collins at 692-8026 or Elaine Jourdane at 692-8027. Should you have any questions about burial matters, please feel free to contact Kai Markell at 587-0008.

Aloha,

Gilbert Coloma-Agaran
State Historic Preservation Officer

EJ:jk

c: Mr. A. Van Horn Diamond, Chair, O`ahu Island Burial Council
Mr. Kai Markell, Burial Sites Program

The comment regarding certain areas with diverse coral reef communities off North Beach at MCBH Kaneohe Bay refers to the Sand Channel Zone (depth 30 to 35 feet) as being characterized by diverse coral reef and coral reef-associated fish community. The channels are deep (up to 4 feet) and exhibit physical complexity, such as overhangs, crevices, and live coral that provide good habitat. According to the Navy consultant who led the SCUBA dive on April 12, 2002, this comment seems to be describing the characteristics of the Reef Flat Zone (depth 30 to 50 feet), which is immediately adjacent to and seaward of the Sand Channel Zone. The biological resources in the Sand Channel Zone are much less bountiful than in the Reef Flat Zone, and the sand in the channels is in a constant state of re-suspension, which restricts settlement of biota on both the sand and limestone reef surfaces. Many of the physical features you mentioned occur in the Reef Flat Zone and not in the Sand Channel Zone. In any case, the undersea cable will cross through both zones that are under discussion in order to connect the buoy array and the land-based portion of the project.

Regarding the concern that the EA does not provide enough detail on the cable-laying methodology, additional verbiage was subsequently included in Section 2.4.1.3 to better explain the work involved in laying the cable from shore to the anchored vessel about 450 feet offshore. We believe that this additional language satisfactorily addresses the concern.

As to the questions regarding the possible need for a mitigation plan to offset unavoidable impacts to coral reefs, we believe that a mitigation plan would not be needed for the following reasons: 1) sparsely situated individual coral heads can be avoided and there

would be only minor impacts to living coral communities; 2) the availability of flat, sandy, and otherwise unencumbered (by coral) submerged substrate for placing equipment on the sea floor; 3) availability of natural features (e.g., channels, fissures) in which to lay the undersea cable without displacing biota; 4) proposed use of divers to check placement of the undersea cable for maximum avoidance of coral communities and reduced chance of damage to the existing resources; 5) planned use of rock bolts and split pipe to secure the undersea cable and WEC equipment to the sea floor, thereby preventing damage to nearby coral and other biological resources from lateral movement of equipment during storm conditions; and 6) a decision to relocate the buoy deployment sites to the northwest in order to stay clear of the comparatively biologically rich ledges at the initial site.

Finally, towards the end of the five-year test period, the Navy will discuss with NMFS and DLNR/DAR the pros and cons of leaving in place the buoy anchor, mooring clumps, and undersea cable. Depending on the amount of encrustation and biological diversity of the plants and animal on the metallic substrate, some of the submerged equipment may be left in place as artificial reef. If this is decided, we have been reassured by the Army Corps of Engineers that the abandoned material would not be considered "fill" under the Clean Water Act and that the act of abandoning, in this case, would not require a permit.

Should you have any questions, please contact Mr. Gary Kasaoka (PLN231GK) of our Environmental Planning Division at 471-9338.

Sincerely,

MELVIN N. KAKU
Director
Environmental Planning Division

Copy to:
ONR (Code 334)
NAVREGHI (N465)
MCBH (LE)

Blind copy to:
NFESC (Code ESC 52)
NFESC (Code ESC 427)
09C
BOS1624



United States Department of the Interior

FISH AND WILDLIFE SERVICE
Pacific Islands Fish and Wildlife Office
300 Ala Moana Boulevard, Room 3-122
Box 50088
Honolulu, Hawaii 96850

In Reply Refer To:
PI-03-09

NOV 4 2002

Commander
Pacific Division, (Attn: PLN231)
Naval Facilities Engineering Command
258 Makalapa Drive, Suite 100
Pearl Harbor, HI 96860-3134

Subject: Review Draft Environmental Assessment (DEA) for Proposed Wave Energy Technology (WET) Project at Marine Corps Base Hawaii (MCBH), Kaneohe Bay, Hawaii

Dear Commander:

The U.S. Fish and Wildlife Service (Service) has reviewed the Draft Environmental Assessment (DEA) for the proposed Wave Energy Technology (WET) project at Marine Corps Base Hawaii, Kaneohe Bay (MCBH-KB). The lead Federal agency for the project is the Department of Defense, U.S. Navy, Pacific Division. The following comments are prepared pursuant to the National Environmental Policy Act of 1969 [42 U.S.C. 4321 *et seq.*; 83 Stat. 852], as amended (NEPA), the Endangered Species Act of 1973 [16 U.S.C. 1531 *et seq.*; 87 Stat. 884], as amended, and other authorities mandating Service concern for environmental values. Based on these authorities, the Service offers the following comments for your consideration.

The proposed project involves the installation of at least two and up to six Wave Energy Converter (WEC) buoys in the nearshore marine environment for the purpose of experimental energy production. These buoys would be deployed for two to five years at which point they would be removed. Each WEC unit includes a buoy, anchor base, hydraulic lines, and equipment canister, and all buoys would connect to undersea cables, land cables, land-based utility vault to house the connection of the undersea cables, and land-based equipment shelter. Buoys would be placed in approximately 100 feet of water with four associated "mooring clumps" placed nearby to allow for stable moorings of workboats associated with installation and periodic inspection of the WEC system.

Commander

2

WEC buoys are approximately 39 feet in length and 15 feet diameter with a spar connecting it to a buoy anchor system which is firmly attached to the seafloor. The buoy anchor is approximately 30 feet square and weighs from 35 to 75 tons. This anchor is rock-bolted to the sea floor providing up to 100 tons of holding force. The equipment canister converts the buoy's mechanical energy to electrical energy, each one is approximately 7 feet square and is also rock-bolted to the sea floor. A maximum of three equipment canisters would be deployed. The transmission cable runs approximately 3,900 feet to shore, is approximately 2.6 inches diameter and would be encased by armoring. The concrete utility vault would be placed above high tide on a gravel bed. The land transmission cable would be encase and elevated using concrete pedestals. The cable would run from the utility vault to an equipment shelter.

The undersea cable would be winched onshore to the utility vault from an anchored vessel approximately 450 feet offshore. The cable would be attached to a cable sled to prevent entanglement on the seafloor and would be guided by a crane positioned on a revetment. The vessel would lay the remaining transmission cable to the WEC buoy. The undersea cable would be anchored by divers along its entire length by either rock bolts or protective split pipe. No trenching would be required. WEC buoy, anchor, and equipment canister would be lowered to the seafloor from a vessel and secured by divers. Vessel would have an anchor system to inhibit movement. Four anchors, each consisting of a 7,000 pound concrete block, attached to a 100 feet length of anchor chain secured taut to a grouted rock bolt in the seafloor. The WEC system would be removed between two to five years after installation using similar installation methods although the cable, buoy anchor, and mooring clumps base might remain in place.

In general the marine communities within the boundaries of the proposed project are not biologically diverse, however, there are some specific areas that do have a diverse coral reef community. Chapter 3 covers the affected environment with Section 3.2.3.2 describing the Sand-Channel Zone (depth 30 to 35 feet) as scoured limestone with some coral and no fish or other marine invertebrates. Based on an April 12, 2002, on-site SCUBA dive conducted by Antonio Bentivoglio of my staff, Steve Dollar, private contractor, and Alan Everson, National Marine Fisheries Service, we maintain this area supports a diverse coral reef and coral reef-associated fish community. The channels are deep (to 4 feet) and exhibit physical complexity, such as overhangs, crevices and live coral, that provide good habitat.

The DEA does not provide enough detail regarding the cable-laying methodology, specifically the cable-sled and crane/revetment components, from the anchored vessel 450 feet offshore in relation to the substrate and potential impacts to the coral reef system. Where the proposed project has significant unavoidable impact to coral reefs, a mitigation plan identifying conservation measures to offset impacts to coral reefs should be prepared and implemented. Therefore, the Service requests additional detail on the cable-laying activities from the shore to the anchored vessel (approximately 450 yards offshore) and methods to avoid and minimize and offset impacts to the existing coral reef ecosystem. The Service is available for further discussions regarding identification of impacts and appropriate compensatory mitigation.

Commander

3

Although the DEA recommends removal of the WEC system within five years after installation the cable, buoy anchor, and mooring clumps base may remain in place. The Service requests clarification regarding whether this would be considered "fill" under the Clean Water Act and require a permit.

The Service appreciates the opportunity to comment on the proposed project. If you have any questions regarding these comments, please contact Antonio Bentivoglio by telephone at (808) 541-3441 or by facsimile transmission at (808) 541-3470.

Sincerely,

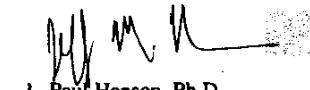

Paul Henson, Ph.D.
Field Supervisor

EPA, Honolulu
NMFS-PIAO, Honolulu
DAR, Honolulu
MCBH-KB, Kailua



DEPARTMENT OF THE NAVY
PACIFIC DIVISION
NAVAL FACILITIES ENGINEERING COMMAND
258 MAKALAPA DR., STE. 100
PEARL HARBOR, HI 96860-3134

5090P. LEL3B
Ser PLN231/ 48

9 JAN 2003

From: Commander, Pacific Division, Naval Facilities Engineering Command
To: Commander, U.S. Army Corps of Engineers District, Honolulu (CEPOH-EC-R)
Fort Shafter, HI 96858-5440

Subj: AGENCY REVIEW OF DRAFT ENVIRONMENTAL ASSESSMENT
(EA) FOR WAVE ENERGY TECHNOLOGY (WET) TEST PROJECT
AT MARINE CORPS BASE HAWAII (MCBH) KANEOHE BAY

Ref: (a) USACE ltr CEPOH-EC-R (1145b) of 9 Oct 02

1. We received your review comment on the subject document in reference (a) in which you indicated that a Department of the Army (DA) permit would be required for the referenced activity.

2. We would like to assure you that your point of contact for this project, Mr. William Lennan, is aware of this project (USACE File No. 200200243) following an orientation meeting aboard MCBH Kaneohe Bay on 23 May 2002 and by his review of the Agency Review (Draft) iteration of the EA in October 2002. Our plan is to submit a DA permit application for the project soon after the Draft Final EA is sent up the chain of command for approval to issue a Finding of No Significant Impacts (FONSI).

3. Our point of contact for the WET EA is Mr. Gary Kasaoka (PLN231GK). He can be reached at 471-9338 or via e-mail at: KasaokaGS@efdpac.navfac.navy.mil.

MELVIN N. KAKU
By direction

Copy:
ONR (Code 334)
NAVREGHI (N465)
MCBH (LE)

Blind copy to:
NFESC (Code ESC 52)
NFESC (Code ESC 427)
09C
BOS1624
ENV1811SB



DEPARTMENT OF THE ARMY
U. S. ARMY ENGINEER DISTRICT, HONOLULU
FT. SHAFTER, HAWAII 96858-5440

REPLY TO
ATTENTION OF

CEPOH-EC-R (1145b)

9 October 2002

MEMORANDUM FOR MR. MELVIN N. KAKU (PLN231), PACIFIC
DIVISION, NAVAL FACILITIES ENGINEERING COMMAND, 258 MAKALAPA
DRIVE, STE. 100, PEARL HARBOR, HAWAII 96860-3134

SUBJECT: Review of Draft Environmental Assessment (EA) for
Proposed Wave Energy Technology (WET) Project at Marine
Corps Base Hawaii (MCBH), Kaneohe Bay, Hawaii

1. Reference your memorandum, 5090P.ONR ser PLN23/2456,
subject as above, dated 2 Oct 02.

2. A Department of the Army (DA) permit will be required
for the referenced activity.

3. Point of Contact for this action is Mr. William Lennan,
CEPOH-EC-R at 438-6986 or FAX 438-4060, File No. 200200243.

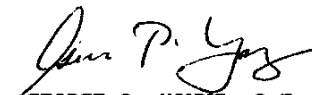
GEORGE P. YOUNG, P.E.
Chief, Regulatory Branch



DEPARTMENT OF THE NAVY
PACIFIC DIVISION
NAVAL FACILITIES ENGINEERING COMMAND
258 MAKALAPA DR., STE. 100
PEARL HARBOR, HI 98860-3134

5090P.1F13B
Ser PLN231/ 49

9 JAN 2003

From: Commander, Pacific Division, Naval Facilities Engineering Command
To: Officer in Charge, 15 CES/CEVP, Hickam AFB

Subj: AGENCY REVIEW OF DRAFT ENVIRONMENTAL ASSESSMENT
(EA) FOR WAVE ENERGY TECHNOLOGY (WET) TEST PROJECT
AT MARINE CORPS BASE HAWAII (MCBH) KANEOHE BAY

Ref: (a) FY03-01 Review Comments on Draft WET EA dated 7 Oct 02

1. Thank you for your review comment on the subject document that was received in reference (a).
2. You commented that submerged equipment, such as the mooring cable and anchor chain, should be removed at the end of the testing period to reduce liability of injury to human and marine animals in the area. In the current version of the EA, we state that the Navy will discuss with the National Marine Fisheries Service (NMFS) and the Hawaii Department of Land and Natural Resources' Division of Aquatic Resources (DAR) at the end of the test period whether to leave in place the buoy anchor, mooring clumps, and undersea cable. Depending on the amount of encrustation and biological diversity of the fauna and flora on the metallic substrate, some of the submerged equipment may be left in place as artificial reef. Other components of the wave energy converter system, such as the buoy and canister, and all land-based ancillary equipment will be removed at the end of the project.
3. Our point of contact for the WET EA is Mr. Gary Kasaoka (PLN231GK). He can be reached at 471-9338 or via E-mail at: KasaokaGS@efdpac.navfac.navy.mil.

MELVIN N. KAKU
By direction

Copy to:
ONR (Code 334)
NAVREGHI (N465)
MCBH (LE)

5090P.1F13B
Ser PLN231/

49

Blind copy to:
NFESC (Code ESC 52)
NFESC (Code ESC 427)
09C
BOS1624

5090P.1F13B
Ser PLN231/ 53

Copy to:
ONR (Code 334)
NAVREGHI (N465)
MCBH (LE)

Blind copy to:
NFESC (Code ESC 52)
NFESC (Code ESC 427)
09C
BOS1624

Comments received from NOAA Fisheries (NMFS) PIAO on agency review (Draft) EA for subject project.

-----Original Message-----

From: John Naughton [mailto:john.naughton@noaa.gov]
Sent: Wednesday, October 16, 2002 7:49 AM
To: Kasaoka, Gary S (EFDPA)
Cc: Alan Everson
Subject: Re: FW: WAVE ENERGY TECHNOLOGY (WET) PROJECT AT MCBH KANEHOE BAY

Thanks Gary:

We have no problem with the proposed project from the habitat prospective. We've surveyed the area several times and there should be minimal impacts on coral reef habitat with the proposed alignment. We do believe, however, that the alternative site off Pearl Harbor should be dropped as not being practical.

Hopefully you will receive ESA Section 7 comments shortly.

John



DEPARTMENT OF THE NAVY
PACIFIC DIVISION
NAVAL FACILITIES ENGINEERING COMMAND
258 MAKALAPA DR., STE. 100
PEARL HARBOR, HI 96860-3134

5090P.1F13B
Ser PLN231/3045

11 DEC 2002

Mr. William S. Devick, Administrator
Division of Aquatic Resources
Hawaii Department of Land and Natural Resources
1151 Punchbowl Street
Honolulu, HI 96813

Subj: Agency Review of Draft Environmental Assessment (EA) for Wave
Energy Technology (WET) Test Project at MCBH Kaneohe Bay

Dear Mr. Devick:

Thank you for your review of the subject document. This responds to your letter dated November 19, 2002.

Before proceeding to address your comments on the EA, we would like to address an issue raised by your letter. A buffer zone would not be created around the buoy array to keep boaters and fishers away. The Navy does not intend to demarcate a "stay clear" buffer zone around the test buoys, but it does intend to post signs on the buoys advising boaters and fishers of the dangers associated with getting too close to the equipment, most of which will be below the water surface and, therefore, not in plain view. By design, the buoys will be undulating up and down and could very easily damage small watercraft that get too close. Larger vessels could very easily damage the equipment and interfere with the research project. We also plan to file a U.S. Coast Guard Notice to Mariners advising boaters of the dangers of venturing too close to the buoy array. Any attempts to vandalize or steal the equipment or to interfere with the experimental design, such as by interrupting the cadence and motion of the buoy assembly, would be dealt with in the same manner as any other abuse, theft, or destruction of U.S. Government property.

Your first comment is that the buoy array portion of the project will be situated in Hawaii State waters. The buoy array will be positioned approximately 1,200 yards from North Beach in order to attain the 100-ft depth needed for the buoys to function properly, but this site is wholly within the Kaneohe Naval Defensive Sea Area (NDSA) established on February 14, 1941 by Presidential Executive Order 8681. At statehood, by virtue of Section 5(c) of the Hawaii Admissions Act, title of the set-aside lands remained in the United States. We responded to a similar inquiry from your department in 1998 by U.S. Navy, PACNAVFACENGCOM correspondence 5090.P.1F3C Ser 231/3148 of 26 August 1998. Although that case involved the Pearl Harbor Naval Defensive Sea Area, which was established by Presidential Executive Order 8143, our position remains consistent. In the case of Kaneohe, the 500-yd buffer zone around the perimeter of Mokapu Peninsula demarcates the extent to which the entry restrictions have been

5090P.1F13B
Ser PLN231/ 3045

suspended. Entry into the buffer zone is by permission only. Nevertheless, the ownership of the submerged lands in the NDSA is not affected by this suspension.

Your second comment mentions invasive and alien seaweed species. Although it may be true that there are serious problems with invasive alien species in Kaneohe Bay, nothing in the administrative record indicates that the WET project would increase the likelihood of spreading these alien pest species in the bay. Plans are to tow or barge the WEC buoy to the project site from the Fuel Pier at MCBH Kaneohe Bay, but we do not see how the installation phase of the project would differ from other shipping and watercraft activities that routinely occur in Kaneohe Bay. Neither the U.S. Fish and Wildlife Service (USFWS) nor the National Marine Fisheries Service (NMFS) have expressed any concern about the possible spread of alien species by this project in their respective consultation letters and at a project briefing that was convened aboard the base on May 23, 2002 to introduce the project to affected regulatory agencies. At the recent *Aquatic Nuisance Species Task Force Conference* (November 13-15, 2002) in Honolulu, there were a number of presentations regarding this alien species problem in Hawaii. However, none of the data and findings presented support your concern that the proposed project would increase the likelihood of spreading marine alien invasive species. In addition, a recent paper published in *Pacific Science* (Smith et al. 2002 vol. 56, no. 3:299-315) entitled, "*Distribution and Reproductive Characteristics of Nonindigenous and Invasive Marine Algae in the Hawaiian Islands*" describes the distribution and reproductive strategies of alien algal species in Hawaii. Of the 19 species of macroalgae that have been introduced to Oahu since 1950, five have become successfully established, with three (*Gracilaria salicornia*, *Hypnea musciformis*, and *Kappaphycus* spp) occurring in Kaneohe Bay. All three of these species were intentionally introduced to Kaneohe Bay in the 1970s, or about 30 years ago, for potential aquaculture projects. *Gracillaria* and *Hypnea* have spread to other islands, while *Kappaphycus* is found only in Kaneohe Bay. All three species are found only in specific habitats (mainly reef flats) that do not include open coastal areas subjected to regular intense wave scour. Therefore, it is apparent that if these alien species had the propensity to spread to the WET site, it is very unlikely that they would become established due to the very unsuitable prevailing oceanographic conditions.

In response to your third comment regarding possible negative ecological impacts of running the undersea cable in crevices as a means to minimize impact to living corals, it is the judgment of the Navy biological consultant and two other individuals representing NMFS and USFWS who dove the project site, that running the undersea cable in the crevices on the seafloor would not result in any significant adverse impacts to the biota. Neither NMFS nor USFWS expressed concern about this in their respective Endangered Species Act (ESA) Section 7 consultation letters. At present, numerous undersea telecommunications cables run through near shore reef habitats throughout Hawaii with no apparent negative effects.

Your fourth comment expressed concern that any lateral movement of the proposed anchoring system would impact the reef environment. A weighted anchor that is rock bolted to the ocean floor will be used. This was decided in order to prevent vertical movement, but it should also

prevent any lateral movement. The following paragraph has additional details regarding the anchor system. Also, after returning from a dive with our biological consultant, NMFS and USFWS agency representatives recommended to the Navy that the buoy array location be moved some distance to the northwest of the original location and parallel to the shoreline in order to reduce impacting the biota on the seabed. This recommendation for repositioning of the proposed buoy array location was adopted and subsequently incorporated into the project design to allay any concerns as to EFH and coral impacts.

Comment five concerns the length of each of three anchoring chains or area of the gravity base. Several months before the Review (Draft) EA was prepared, the developer of the Wave Energy Converter (WEC) buoy decided against using anchoring chains that extended outward from the central base and to instead use heavily weighted anchor base weighing 35 to 75 tons (32-68 metric tons) for each buoy to prevent vertical movement. For insurance, the flange frame of the anchor base plate would be rock bolted to the ocean floor to prevent horizontal or lateral movement with a holding force of up to 100 tons (91 metric tons). We believe this approach would minimize the footprint of each buoy anchor and effectively eliminate the possibility of the anchor base breaking free and drifting away in all but the most severe storm conditions (>500-yr storm). As stated earlier, the proposed location for the anchoring the buoys was chosen based on recommendations made to the Navy by NMFS and USFWS biologists following a dive at the project site for the expressed purpose of minimizing impact to the seabed by the anchor base. This buoy array site is characterized by a flat, barren reef platform. Bottom conditions at the proposed buoy array site do not offer unique habitat for species such as goat fish, which occur in the area. The species present would be displaced to adjacent areas.

Your sixth comment expresses concern that the metallic anchor bases would serve as substrate for cyanobacteria or blue-green algae (*Lyngbya* spp). This concern is questionable as there are numerous metal anchors, buoys, sheet piling, mooring and Fish Aggregation Devices (FADs), and artificial reef initiatives throughout the state that, apparently, do not cause any such problems. Furthermore, we do not believe that there is any evidence that the growth rates, or total biomass of blue-green algae will be affected by the proposed project. According to our biologists, the metallic anchor base would provide good substrate for coral growth, which would be a beneficial effect for an area relatively devoid of living coral. Information from field surveys and dives indicates that the project area where the anchor bases and undersea cable will be positioned does not have an abundance of reef building corals, mainly due to the scouring effect of the strong currents, turbulent water, and sand. That is to say that the natural seafloor at that site is not conducive to prolific coral growth due to harsh conditions. Hence, the artificial substrate that will be created by the metallic anchor base should stimulate coral growth in the area. Photographs taken by our biological consultant indicate that other man-made artifacts currently on the seafloor off North Beach have a higher density and diversity of marine growth, including corals, than the immediately adjacent natural areas, with no cyanobacteria mats. We expect that enhanced growth of corals and other sessile species, such as sponges and seaweed,

stimulated by the availability of new substrate, will have a net benefit to the marine community at the project site.

Your seventh comment questions whether the buoy system would endanger protected species such as sea turtles and whales with regard to noise and risk of entanglement. As described in the EA, we do not anticipate any significant impact on any of the threatened and endangered species from noise generated from the installation and operation of the WEC system. Furthermore, the potential danger of entanglement to those listed species is not significant. The original plan of securing the WEC buoys to the seafloor with anchor chains has been replaced by a weighted base and rock bolts. Entrapment of marine mammals and sea turtles within the buoy structure is unlikely. The top of the buoy is closed, and the bottom is open, allowing ingress and egress through only one end. The size of the opening provides a ready egress path. The interior of the buoy is free of obstruction, sharp edges, and corners. No horizontal flat surfaces exist within the buoy to provide resting sites for animals such as marine turtles.

Your eighth comment is on monitoring and protocol. We believe every effort has been made during project planning to minimize impacts to the bottom biota (i.e., corals and associated organisms). Best management practices (BMPs) will be applied during installation of the buoy system and ancillary equipment, which should eliminate danger to any threatened or endangered species and ensure that any loss of coral and other benthic organisms would be prevented to the maximum extent practicable. If a threatened and endangered (T&E) species were to approach the active worksite, work activity would be suspended immediately in accordance with BMP rules until such time that the animal leaves that site under its own volition. We believe that water clarity at the project site and the strategy of avoidance will allow us to prevent any unintended consequences regarding safety of T&E species. As requested by NOAA Fisheries (a.k.a., NMFS) under informal ESA Section 7 consultation, buoy maintenance divers will be directed to examine inside buoys for any indication of sea turtle or other protected species interaction. Any evidence of T&E species interaction caused by entrapment or entanglement will be reported to that agency's Pacific Islands Area Office.

Your ninth comment concerns major coral spawning events in Kaneohe Bay. The Navy recognizes that these spawning events do occur and that they are an integral part of the natural cycle. However, we do not believe the WET project will impair the viability of these spawning events over existing conditions in Kaneohe Bay. In fact, the electromagnetic radiation (EMR) field from the undersea cable will be weak. More importantly though, the project will not be sited on or near a coral reef so the quantity of coral gametes and larvae that are likely to be exposed to any project related EMR source should be small. The extensive literature search conducted for the EA did not produce information relative to the effects of electric and magnetic fields on corals. The amount of living coral at the project site is not as great as in other areas of Kaneohe Bay. Furthermore, ocean conditions at the project site, as compared to the calmer waters within the protected portions of the bay, would minimize the amount of time that any gametes or larvae would be exposed to EMR. The same situation would apply to any electrical

JENJAMIN J. CAYETANO
GOVERNOR OF HAWAII

5090P.1F13B
Ser PLN231/ 3045

leakage and heat released from the system. Heat losses from the cable would have negligible impacts on seawater temperature in the vicinity of the cable, due to the immediate dissipation by natural flow of seawater. The thermal resistance of the sediments or other seafloor material is substantially higher than that of seawater. Therefore, the heat transferred directly to seabed materials would be negligible.

Your tenth comment on fishers in vicinity of the buoy array has already been addressed in our second paragraph of this letter.

Thank you once again for your input. The Navy wants to continue our working relationship with DLNR/DAR. We appreciate your attempts to meet our schedule and deadlines during this holiday season. Should you have any questions, please contact Mr. Gary Kasaoka (PLN231GK) of our Environmental Planning Division at 471-9338.

Sincerely,

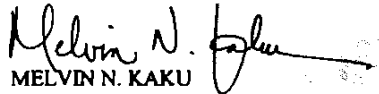
MELVIN N. KAKU
Director
Environmental Planning Division

Copy to:
ONR (Code 334)
COMNAVREG Pearl Harbor, HI (N465)
MCBH Hawaii (LE)

Blind copy to:
NFESC Port Hueneme (Code ESC 52)
NFESC Port Hueneme (Code ESC 427)
09C
BOS1624



STATE OF HAWAII
DEPARTMENT OF LAND AND NATURAL RESOURCES
DIVISION OF AQUATIC RESOURCES
1151 PUNCHBOWL STREET
HONOLULU, HAWAII 96813

GILBERT S. COLOMA-AGARAN
CHAIRPERSON
BOARD OF LAND AND NATURAL RESOURCES

DEPUTY DIRECTOR
ERIC T. HIRANO

DEPUTY DIRECTOR
FOR THE COMMISSION ON
WATER RESOURCES MANAGEMENT
LINNELL T. HISHOKA

AQUATIC RESOURCES
BOATING AND OCEAN RECREATION
COMMISSION ON WATER RESOURCES
MANAGEMENT
CONSERVATION AND RESOURCES
ENFORCEMENT
CONVEYANCES
FORESTRY AND WILDLIFE
HISTORIC PRESERVATION
KAHOOLAWE ISLAND RESERVE
COMMISSION
LAND
STATE PARKS

11/ 19/02

Mr. Melvin Kaku, Director
Environmental Planning Division
Naval Facilities Engineering Command
Department of the Navy
258 Makalapa Dr., Ste. 100
Pearl Harbor, HI 96869-3134

Dear Mr. Kaku:

Thank you for the opportunity to comment on the draft Environmental Assessment for the Proposed Wave Energy Project off the Marine Corps Base Hawai'i (MCBH). We understand that the Department of the Navy is proposing to install and test up to six Wave Energy Conversion (WEC) buoys off of North Beach at the MCBH. The primary purpose is to gather data regarding this new technology and the project is proposed to last up to five years. Each of the buoys would be anchored in roughly 30 m (100 ft) of water using a ballasted anchor system that is in turn bolted to the seafloor. Each buoy would be 4.5 m (15 ft) wide and 15 m (45 ft) long. It also our understanding that a buffer zone would be created around the array to keep boaters and fishers away, resulting an overall marine project area of 375,000 m² (403,440 ft² or 9.5 acres).

As the buoy array portion of project is proposed to be situated in State waters (as opposed to the first version of this draft EA which promoted placement within the 500 yd security zone), the Division of Aquatic Resources should be directly included in site inspections, plan reviews, and monitoring plans related this project. Primary concerns and suggestions are listed below:

1. The document calls for the placement of the buoy array and buffer zone roughly 1,189 m (3900 ft) offshore, which is approximately 800 yards beyond the existing 500 yard security zone for the MCBH. Originally, the buoys were intended to be placed within the 500 yard security zone

around MCBH. The site clearly sits in State waters and would constitute a restricted use of public natural resources by a single entity, suggesting the need for a DLNR Conservation District Use Permit (CDUP) and/or Land lease agreement.

2. Kane'ohē Bay is currently one of the greatest problem spots in the entire State for invasive and/or alien seaweeds. A number of species that are overgrowing and killing off coral habitat in the bay are currently not found immediately outside the bay or anywhere else in Hawai'i. We should have extremely strong concerns regarding research, construction or military efforts which might inadvertently result in the introduction of these devastating species outside of the areas in which they already occur. The movement of large marine equipment and long-term anchored objects so close to Kane'ohē Bay raises strong alien species vector ecology issues associated with this project.
3. The Installation Site Plan proposes to site at least 3,900 feet of cable from the buoy locations shoreward. As the proposed site is presumably exposed to relatively high wave energy given its location and the needs of the project, we have concerns regarding the ecological impact of siting cable into any crevices which may serve as primary fish & invertebrate recruitment sites for this location. We would need to conduct a site visit with our biologists to determine if this is a real concern and how it might effect the marine natural resources in the area.
4. The buoys are proposed to be located in 100 feet of water in an area that is exposed to large winter surf. Without having visited the area and detailing the bottom cover, we are concerned that any lateral movement of the proposed anchoring system would impact the reef environment.
5. Little information is provided regarding the length of each of the three anchoring chains or area of the gravity base. Given that six of these buoys are proposed, each being roughly 49 feet long and 15 feet wide, we are concerned regarding the footprint that each of these anchoring systems will have on bottom habitat.
6. Recent data from the NWHI and American Samoa suggests that large pieces of metal left atop coral reef habitats for extended periods of time may result in facilitating the growth and expansion of cyanobacteria or blue-green algae (*Lyngbya* spp.). Given the suggested relatively large size of the anchoring system, the use of large amounts of scrap steel and chain for the anchor weights, and the length of the experiment (five years), there may be concerns regarding such an event occurring with this proposed research.
7. Will noise generated from the buoy itself or movement of the anchoring system effect protected species such as turtles or whales known to frequent the area? Likewise, is there an entanglement risk posed by this system to indigenous, threatened and endangered wildlife protected under State and laws?
8. What types of monitoring are proposed for this project? Specifically, how will biological impacts be monitored and what protocols are proposed to minimize such impacts?
9. In recognition of the long history of accurately predicting major coral spawning events in Kane'ohē Bay for corals such as *Porites compressa*, *Montipora capitata* and *Fungia scutaria*, we suggest that the EA include recognition of coral spawning events when planning MCBH activities associated with this project that may impact the viability of such spawning events in Kane'ohē or Kailua Bays. Specifically, while electromagnetic radiation (EMR), electrical

leakage and heat release may have minimal effects on adult and juvenile organisms in the area, there is no data presented regarding impacts to gametes and larvae during the annual spawning periods. Side note: There is preliminary data available from Goreau *et al.* regarding electrical current enhancing calcification in coral colonies.

10. The document does not discuss in detail (with the exception of a single short paragraph (section 4.2.9.2)) on how local fishers will be dealt with when approaching the array. Given the duration, location and physical in-water size of the project, there is a high likelihood of fishers trolling around the buoys themselves (or at least the buffer bouys if they are placed around the array). No discussion is made of spearfishing around the cylinders.

We appreciate this opportunity to provide comment. If you have any questions, please call Mr. David Gulko at (808) 587-0318.

Sincerely,



William S. Devick, Administrator
Division of Aquatic Resources

Cc: Sam Lemmo, Division of Land Management, DLNR

Francis Oishi, DAR
Dave Gulko, DAR
Richard Sixberry, DAR
Ecological Services, USFWS
PIAO, NMFS

Appendix D

“Marine Natural Resources Insert for the WET EA.”
July 2002. Prepared by Steve Smith, PACDIV,
Pearl Harbor, O‘ahu, Hawai‘i

MARINE NATURAL RESOURCES INSERT FOR THE WET EA

Prepared by Steve Smith 15 July 2002

NOTE

There is a detailed discussion of marine natural resources in the *Pearl Harbor Integrated Natural Resources Management Plan* Final Version October 2001 (INRMP). The marine natural resources of Pearl Harbor are not treated in the *Naval Magazine Pearl Harbor INRMP*; that document references the Pearl Harbor one. PACDIV has provided BCH with at least one copy of the Pearl Harbor INRMP. The Pearl Harbor INRMP should be used, or referenced for the WET EA.

The brief discussion below is not intended to replace the material presented in the Pearl Harbor INRMP. Extensive species lists are included in both the Pearl Harbor INRMP and the Fort Kam EIS.

INSERT (Description Section)

The *Pearl Harbor Integrated Natural Resources Management Plan* (INRMP) was issued in October 2001, which includes a detailed discussion of marine natural resources within Pearl Harbor. The Pearl Harbor Entrance Channel (from Fort Weaver Wharf seaward to the outermost channel marker buoys), and the adjacent areas, are not addressed in the plan.

The Department of Defense (DOD) Coral Reef Protection Implementation Plan is currently completing a detailed quantitative survey of the Pearl Harbor Entrance Channel (Entrance Channel), and the inner portions of Pearl Harbor. The results of this survey are expected before the end of 2002. In addition, marine natural resource information is presented in the *Final EIS Outfall Replacement for Wastewater Treatment Plant at Fort Kamehameha, Navy Public Works Center, Pearl Harbor, Hawaii* issued in March 2001.

The Entrance Channel can be subdivided into four major components or zones: (1) channel bottom, (2) channel slope, (3) channel wall and (4) fossilized reef platform. Components three and four are not present along the entire Entrance Channel.

Channel Bottom

The channel bottom is composed primarily of calcareous sand and is generally very flat. Between the inner portions of the Entrance Channel, and the outermost Channel Marker Buoys (approximately 3.2 km), the average depth increases from 14 m to 18 m and the substrate becomes coarser and contains more rubble moving seaward. During investigations for the Fort Kamehameha outfall replacement, detailed quantitative studies were completed (Smith, unpublished 2000). Reef building corals do occur, however, they are extremely sparse and cover only 0.13% (less than 1/7th of one percent) of the seabed. The ongoing studies, being performed as part of the DOD Coral Reef Protection Implementation Plan, appear to show that similar, very sparse coral development is

present on the west side of the channel bottom, and algal growth is also very sparse. The most significant feature is sea grass, primarily *Halophyllia decipiens*. The bottom does not appear to support significant numbers of fish. The total number of fish and diversity of species is low with the most noteworthy being spotted eagle rays frequently seen feeding on the seafloor, and schools of yellowfin goatfish (*Mulloidichthys vanicolensis*) numbering over 100 individuals. A substantial number of crab and shrimp burrows are present in this area.

Channel Slope

The channel slope shows great variability at different points in the Entrance Channel. The slope ranges in width from 2 m to over 30 m. It begins as shallow as 4 m, to as deep as 12 m. In all portions of the Entrance Channel, the slope is dominated by dead coral rubble and coarse calcareous sand. At the innermost portions of the Entrance Channel, on the west side, this dead coral rubble and sand is overlain by substantial amounts of terrigenous material, such as leaf litter and mangrove propagules. No terrigenous material has been observed seaward of Channel Marker Buoy No. 7. Coral cover is extremely sparse. Sea urchins appear to be the dominant benthic invertebrate on most sections of the slope and fish species are more diverse than over the channel bottom.

Channel Wall

The channel wall is a relatively rich zone. As with all the components of the Entrance Channel, the flora and fauna become increasing diverse and abundant in a seaward direction. The wall is better developed on the west side of the Entrance Channel. The wall starts at depths ranging from 2 m to as deep as 6 m, with the base of the wall never greater than 13 m; the longest vertical face observed was 7.5 m. Shoreward of the Entrance Channel Buoy No. 5, coral cover on the wall is sparse, however proceeding seaward, coral cover increases dramatically. Rice coral (*Montipora patula*) is the dominant coral growing in this zone, but many other species are also represented. Many portions of the wall contain grottos and deep undercuts near the base, which extend back for over 2 m, in some cases. Green sea turtles (*Chelonia mydas*) have been observed, resting in these recessions, along with Whitetip reef sharks (*Triaenodon obesus*) and reef blacktip sharks (*Carcharhinus melanopterus*). All the major families of Hawaiian reef fishes are represented in this zone.

The wall is not present in all portions of the Entrance Channel. In some areas, large blocks (up to 5 x 4 x 4 m) have broken off, and occasionally these blocks are less than 2 m from the wall, thus creating narrow passageways that are frequented by green sea turtles and many species of fish. The most highly developed section of the wall, with associated broken block formations, is located on the west side of the Entrance Channel between Channel Marker Buoy No. 1 and No. 3.

Fossilized Reef Platform

The fossilized reef platform extends further offshore on the west side of the Entrance Channel, than on the east side. On the east side, some portions of the platform are out of the water at low tide. The flora and fauna for the east side have been described in the EIS for the Fort Kamehameha outfall replacement. The platform community on the west side of the Entrance Channel is very similar to the east side, but appears to be better developed, and covers a larger geographic area. The depth on the west side ranges from 2 m to 6 m and there is a modest spur and groove development on top of the platform at depths below 5 m. Live coral cover is modest on most portions of the platform although there are some small areas on the west side, seaward of Channel Marker Buoy No. 3 which support dense coral development, where the dominant species are cauliflower coral (*Pocillopora meandrina*), rice coral (*Montipora spp.*) and lobe coral (*Porites lobata*). Other sessile and benthic invertebrate species are well represented, and as with the channel wall, all the major families of Hawaiian reef fish are present.

INSERT (Impact Section)

Marine resources have been observed in the Entrance Channel, including green sea turtles, coral communities, and fish habitat. There are also large areas that are relatively immune to potential impacts, specifically the channel bottom and channel slope. Adverse impacts to marine resources can be avoided by careful routing of the WET undersea cable along the channel bottom and channel slope.

Appendix E

Coastal And Oceanographic Setting For WEC Buoy Site
Marine Corps Base Hawaii. May 2002.
Sea Engineering Inc.

**COASTAL AND OCEANOGRAPHIC SETTING
FOR
WEC BUOY SITE
MARINE CORPS BASE HAWAII**

May 2002

Prepared for:
Belt Collins Hawai'i
2153 North King Street, Suite 200
Honolulu, Hawaii 96819

Submitted by:
Sea Engineering, Inc.
Makai Research Pier
Waimānalo, Hawai'i 96795

1 COASTAL SETTING

1.1 Introduction

The coastal waters off the Marine Corps Base Hawaii (MCBH) have been selected as a site for a demonstration installation of Wave Energy Conversion (WEC) buoys.¹ At least two, and possibly six, buoys will be installed at the site over the next few years. The duration of the demonstration program will be five years. At the end of that period, all buoys, cables and anchors will be removed from the site.

Sea Engineering, Inc. was retained by Ocean Power Technologies, Inc. (OPT) to conduct a preliminary site feasibility assessment, which was completed in July 2001. This assessment included one day of diving and bathymetric survey work at the site, as well as a summary of prevailing and extreme wave conditions at the site. Subsequent work conducted in 2002 included a side scan survey to identify any potential obstacles or high relief bottom areas, and to provide information to support selection of buoy anchor sites and a feasible cable route from the buoy to shore. The side scan survey was supplemented by a day of diving at the site to verify the side scan results and to investigate the cable route alternatives. The information contained in this document is based upon the previous work, as well as additional fieldwork undertaken specifically for this Environmental Assessment.

1.2 Shoreline Conditions

The project shoreline extends from Pyramid Rock to the east end of the military housing development, a distance of approximately 8,000 feet. Most of the shoreline of this 8,000-foot long reach consists of a sandy beach and the entire area is known as "North Beach". The entire Mokuapu peninsula is occupied by the Marine Corps Base Hawaii. Shoreside access to the beach is limited to military personnel and their dependents. A "Prohibited Zone" extends 500 yards seaward of the beach, and civilians are not allowed to enter this zone. This prohibition is enforced by both the MCBH Waterfront Operations and the lifeguards stationed on the beach.

The 8,000-foot long beach is continuous except for a rock revetment protecting the seaward end of the main base runway. The 2,000-foot long shoreline between Pyramid Rock and the runway is generally undeveloped. The beach is 80 to 100 feet wide and is backed by extensive sand dunes. There is easy access for recreation, and this portion of the beach is heavily used. The offshore area is a popular bodysurfing, surfing and swimming site. Photo 1 shows the runway revetment and the west end of the beach.

The rock revetment, approximately 1,100 feet long, protrudes into the ocean and protects the seaward end of the main runway. The airfield extension and the revetment were constructed in 1939. The seaward toe of the revetment is in the water, and there is no beach fronting the revetment. East of the runway, a 5,500-foot long sandy beach extends to the steep cliffs of Ulupau Head. Photo 2 shows the beach area immediately east of the runway revetment. A golf

¹ One alternative considered as the test site for this project is MCBH. This report analyzes shoreline conditions at two sites along North Beach, MCBH Kaneohe Bay.

course occupies most of the backshore area in this sector, and is located just behind the sand dunes visible in Photo 2. The band of sand dunes extends all the way to the military housing, which is situated on a bluff overlooking the easternmost 1,000 feet of the beach. A massive 600-foot long rock and concrete revetment has been built at the east end of this section.

The beach fronting the golf course and the military housing is also popular for recreation. There are stairs to the beach from the military housing, and military dependents frequent that part of the beach. Another popular surf site is located just of the west end of the housing development. Sections of raised reef and beach rock border the east end of the beach, and the offshore formations offer protection from the incoming waves. Photos 3, 4 and 5 show the conditions at the east end of the beach. The offshore area off the extreme east end of the beach is very irregular, with basalt shelves and exposed limestone outcrops. The basalt shelves form protected swimming areas inshore, and this beach area is heavily used by military dependents

Although North Beach is not pristine, most of the development has taken place behind at least the seaward row of sand dunes. The major exceptions are the runway revetment and the protective revetment in front of the military housing. The beach area east of the runway is narrower than that to the west, with an average width of 50 to 60 feet.

The extensive sand dunes that remain along much of the shoreline are archaeologically sensitive, and Moku Peninsula in general contains very important archaeological sites. Over 300 skeletons were uncovered during the construction of the airfield extension and revetment in 1939 (AECOS, 1979). The sand dunes between the golf course and the beach are rated as "high value" in the State Register of Historic Places. The main runway area covers the ruins of old Hawaiian villages.

1.3 Offshore Characteristics

The evaluation of the offshore characteristics was completed in several increments. An initial one-day feasibility investigation was conducted on June 29, 2001. The objective was to evaluate the general characteristics of the area to determine whether or not it would be feasible to install a WEC buoy in the area, and if there were potential cable routes to the shore. Prior to this investigation, the military requested that the project, and specifically the cable, be sited so that the archaeologically sensitive sand dunes in the area would not be disturbed. This constraint limited the cable landing site to one of three areas: the rocky shoreline where Pyramid Rock meets the sandy shoreline of North Beach; the rock revetment protecting the runway; and the shoreline fronting the military housing at the east end of the beach. This landing site constraint also somewhat limited the potential offshore locations for the buoy, since it is preferable to route a cable to shore so that it is approximately perpendicular to the bottom contours, in order to minimize the wave forces on the cable.

The area near Pyramid Rock was eliminated from consideration for the following reasons:

- At the time of the initial investigations, a second wave energy demonstration project was being proposed for the area just seaward of Pyramid Rock, and a buffer between the two projects was desirable.

- In order for an electrical cable to cross the shoreline in the area without disturbing the sand dunes, the cable would have to be parallel the shoreline inshore of the seaward tip of Pyramid rock, and come ashore at the intersection of the rocky shoreline of the point and the sandy beach. This route would cross an extensive area of shallow reef directly below a popular surf site.
- Placing the WEC buoys at the 100-foot depth contour off Pyramid Rock would require a considerably longer cable than elsewhere off North Beach.

Given the site constraints described above, the initial work was concentrated on two areas: the military housing at the east end of North Beach and off the MCBH runway. The work consisted of dive tows to determine general bottom conditions, limited bathymetric surveying to determine general depth contours, and spot dives in selected areas. Initial site selection and feasibility assessment was based upon the following criteria:

- Proximity of the 100-foot contour to the shoreline, thereby minimizing the required cable length.
- A relatively flat bottom in the vicinity of the 100-foot depth contour, with little biological diversity, for installation of the WEC buoy anchors.
- A suitable cable route to shore, with a minimum of vertical relief. The vertical relief is a major factor, since it can cause free spans in the cable, which is very undesirable. Conversely, the presence of sand deposits along a potential route is very favorable, since a cable tends to self bury in the sand in the presence of wave action.
- The ability to cross the shoreline interface while avoiding the sand dunes behind the beach, without approaching the shoreline at too great an angle from the perpendicular.
- In many areas around the main Hawaiian islands, an ancient sea level stand is defined by a steep or vertical ledge at the 40 to 70-foot depth, and this feature can present a major obstacle to cable routing. Many fiber optic cable landing sites have been selected with avoidance of this ledge a primary criteria.

During the initial investigation, it was determined that the area off the MCBH runway was suitable for a WEC buoy installation, and routing a cable to shore would be feasible. Subsequent work undertaken offshore included more detailed bathymetry of the area off the runway, a side scan survey to check for obstacle in the area of the buoy anchorage and to assist in cable route selection, and two days of diving to verify the side scan results and select the optimum cable route and characterize the bottom for this EA. The following discussion of the bottom conditions is based on the work undertaken at the site to date.

The physical characteristics of the nearshore bottom off North Beach can be described by several bands, or zones, which approximately parallel the shoreline and can be defined by water depth:

- With the exception of the extreme east end of the beach, the ocean bottom just seaward of the beach is sandy, with some widely scattered outcrops of scoured limestone. The sand typically extends to about the 15-foot water depth. Average width of this zone ranges from 400 feet at the east end of the beach to 700 feet near Pyramid Rock. Photo 1 shows the sandy area immediately off the base runway. This sand may shift seasonally, with the limestone outcrops first exposed, then buried.

- Immediately seaward of the sand zone, the bottom consists of consolidated limestone bisected by small channels, some of which contain a very thin veneer of sand. These are spur and groove formations common to most shallow nearshore areas around Oahu. This zone extends from approximately the 15-foot depth to the 35-foot depth. There is a 3 to 4-foot elevation change between the bottom of the channels and the adjacent ridges. While the channel bottoms are typically flat, scoured limestone with a thin veneer of sand occasionally present, there is coral present on the ridges. Photo 6 shows a good example of a spur and groove formation. This zone, because of the vertical relief, presents the major challenge to the cable routing off North Beach. Although the spur and groove formations are generally oriented perpendicular to the bottom contours and the shoreline, the channels unfortunately are not continuous. They vary in width and eventually dead end in ridge formations. While the channels to some extent provide a suitable cable route, none offer a continuous path through this zone, and some areas with significant vertical relief must be crossed. The vertical relief in this zone increases in the direction of the military housing. Off the military housing, in water depths of 20 to 30 feet, there is a 600-foot wide area that has numerous steep ledges and overhangs. Large slabs of limestone are undercut and many have slumped into the deeper pockets of the bottom. Vertical relief in this area is typically 5 to 6 feet, and the bottom is not at all suitable for a cable route. This feature, together with the basalt outcroppings near the shoreline, the heavy recreational use of the beach, and the difficulty of routing the cable up the step shoreline bluff, combined to eliminate this end of the beach from further consideration. The increasing degree of bottom relief with distance toward the east end of the beach was also noted in previous work (AECOS (1979)).
- The spur and groove formations taper out in 30 to 35 feet of water, and the bottom from that point to approximately the 50-foot depth is a wide plateau of relatively flat limestone, with some scattered areas of vertical relief, generally due to potholing, coral growth or the presence of small limestone ridges and ledges. These areas of higher relief are widely scattered and can be avoided during cable placement. Photos 7 and 8 show typical conditions in this zone. The bottom slope in this zone is approximately 1V on 70H.
- The bottom slope increases sharply seaward of the 50-foot contour, and the drop-off continues to approximately the 95-foot contour. While bottom slopes as steep as 1V on 7H are present in this zone, there are no prominent vertical ledges or undercut areas that are common to this water depth in other areas around Oahu. The bottom is relatively flat limestone, similar to that in the previous zone. Again, the areas of vertical relief are widely scattered, and can be easily avoided during the cable placement.
- Seaward of the 95-foot contour, the bottom slope flattens out and the limestone bottom becomes almost featureless. Photos 9 and 10 show typical conditions at the 100-foot water depth. There is a thin veneer of sand over the limestone in some areas, but it is only an inch or two thick.

1.4 Inshore Cable Route

Two potential cable routes were initially selected based upon the side scan results. Both routes crossed the shoreline at the east end of the runway revetment. During the subsequent diving investigations, one of the routes was discarded due to significantly higher bottom relief in the 15 to 35-foot deep zone. Figure 1 shows the bathymetry off the MCBH runway, the selected cable

route, the boundaries of the inshore sand zone, and a smaller sand deposit through which the cable will be routed. Because of the importance of routing the cable properly through the 15 to 35-foot deep bottom zone, on April 10 a line was placed along the selected route using differential GPS for positioning. Divers then inspected the route and adjusted the line to take maximum advantage of favorable bottom features and to avoid areas of vertical relief to the maximum extent possible. The new position of the line was then re-mapped. The route selected takes maximum advantage of the branches of the sand deposit that extends seaward from the beach, and also utilizes the deeper surge channels whenever possible.

Photos 11 through 22 illustrate the bottom conditions from the 35-foot depth contour to the shoreline, a distance of 1,200 feet. Photo 11, taken in 35 feet of water, shows the relatively flat bottom typical of the 35 to 50-foot bottom zone. Photo 12, taken in 30 feet of water, shows a typical spur and groove formation. The photo shows the channel narrowing in width in the background, and another channel can be seen in the far background. The cable route was selected to take advantage of the flat channel bottoms, and minimize the extent of vertical relief that must be crossed. Photo 13 (28-foot depth) shows the end of a channel where the cable must cross a ridge area. Photo 9 (28-foot depth) shows typical conditions on the ridge formations between the channels. The cable will be routed to avoid the higher relief areas shown on the left side of the photo. This ridge area covers a distance of approximately 225 feet. Photo 15 (22-foot depth) shows a ridge formation in the background that the cable will cross before dropping into the seaward sand deposit shown on Figure 1. There is a three-foot rise onto the ridge, a 25-foot long section on top of the ridge, and then 3-foot drop into the sand deposit. Photo 16 (19-foot depth) shows typical conditions at the seaward end of the sand deposit. The deposit has numerous limestone outcrops, and is less than one-foot thick in this area. As in other area, the cable will be routed to avoid the higher relief areas to the side. Photo 17 (19-foot depth) shows conditions in the middle of the offshore deposit. Sand thickness through this part of the deposit ranges from 1 to 2 feet and there are scattered large limestone outcrops such as the one shown in the photo. These can be easily avoided during cable placement. Photo 18 (15-foot depth) shows the three-foot high limestone ledge that forms the inshore boundary of the sand deposit. Once on top of the ledge, the cable will be routed across a 50-foot band of scoured limestone (Photo 19) until it drops into the sand deposit off the beach. There are widely scattered outcrops of scoured limestone in the sand deposit off the beach, and the exposure of the limestone probably varies seasonally. Photos 20 and 21 show examples of the outcrops. Sand thickness in this inshore deposit exceeds 3 feet in some areas. Photo 22 shows basalt boulders that have apparently been moved off the revetment by wave action. The boulders are scattered over a 150-foot wide zone. The revetment is immediately inshore of this zone.

2 OCEANOGRAPHIC SETTING

2.1 Background

Sea Engineering, Inc. (2001) summarized the available oceanographic data pertinent to the proposed installation of the Ocean Power Technologies wave energy system. The report also included an extrapolation of the extreme design conditions. The following description of the oceanographic setting is based upon that report.

2.2 Depth Datum and Tide

The tides in Hawaii are semi-diurnal with pronounced diurnal inequalities; that is, there are two tidal cycles per day with unequal water level ranges. *Tide Tables 2001*, which is based on tide data from U.S. Department of Commerce, National Oceanic and Atmospheric Administration, National Ocean Survey (2000), gives a mean tide range of 0.43 m and a diurnal range of 0.67 m at Kaneohe Bay. Tidal data is summarized below:

Mean Higher High Water	0.67 m
Mean High Water	0.55 m
Mean Tide Level (approx. MSL)	0.34 m
Mean Low Water	0.12 m
Mean Lower Low Water	0.0

Water depths on NOAA charts pertaining to Hawaii are typically in fathoms and are referenced to a mean lower low water (MLLW) datum. Water depths on USGS topographic charts are in feet and are referenced to a MLLW datum, but the topographic elevations on the charts are referenced to a mean sea level datum (MSL).

2.3 Currents

Three predominant factors influence the currents around Hawaii; the semi-diurnal tide, the underlying large-scale oceanic current, and wind influence on the upper layers. In most areas, the semi-diurnal tide is the dominant driving force. The semi-diurnal tide currents parallel the bottom contours, and reverse with the stage of the tide. The underlying oceanic flow approaches Oahu from the northeast and diverges somewhere between Mokapu and Makapuu. The reversing tidal currents are superimposed on this flow, with flood tide currents generally moving to the east, and ebb tide currents to the west. The resultant net transport of water is to the northwest. The wind typically influences the upper 15 feet of the water column during tradewind conditions.

Typical currents associated with the semi-diurnal tide are about 0.5 knots, with speeds of 1 knot common. For most coastal areas, the annual maximum would be in the vicinity of 2 knots. There are, however, some areas where offshore eddy formation or unusual bathymetric or coastal configurations result in higher current speeds. There is no evidence to suggest that the project site is one of these areas.

We were unable to locate any current measurements taken at the proposed site. However, currents around Oahu were summarized in the *Circulation Atlas for Oahu, Hawaii* (Bathen, 1978), which is based upon all current measurements collected around Oahu prior to 1978. The atlas indicates that currents at the site are reversing, paralleling the bottom contours, with flood currents moving to the east and ebb currents moving to the west. The maximum predicted current speed is 1.2 knots during flood tides, and 1.0 knot during ebb tide. This pattern is consistent with local knowledge, observations in adjoining coastal areas, and with data collected in Kailua Bay, the large coastal embayment east of Mokapu Peninsula.

2.4 Water Quality

The waters off North Beach are classified "A" by the state Department of Health.

2.5 Winds

The International Station Meteorological Climate Summary (1996) jointly produced by Fleet Numerical Meteorology and Oceanography Detachment, National Climatic Data Center, and USAFETAC OL-A provides annual and monthly summaries of winds based on hourly observations and monthly peak gusts measured at the base airfield.

The annual wind summary from that publication is presented in Table 1, which gives the percent frequency distributions for winds at the weather station. The summary is based on wind data collected from 1945 and 1995. The tabulated winds are two minute averages taken hourly for a 24-hour day. The peak gusts are summarized in 3.2 of this report.

On an annual basis, over 70 percent of the winds were tradewinds from the sector northeast through east-southeast with an average speed of approximately 10 knots (5 m/s). The easterly tradewinds were most frequent in summer months.

The report referenced above also gives monthly peak gusts based on daily measurements at the air station at the MCBH. The peak gusts are instantaneous winds and the data set does not specify the time duration for the gust. Table 2 presents the monthly peak gusts measured at the site between 1948 and 1995. Table 3 summarizes the monthly wind conditions, and includes average winds, peak gusts, and estimated 1-minute and 10-minute wind speeds. The 1-minute and 10-minute wind speeds were calculated based on methodology described in the *Shore Protection Manual* (1984), assuming that the peak gusts were 3-second wind speeds.

The thirty-six annual peak gusts listed in Table 2 were used to determine the statistical peak gusts for given return periods, using Gumbel's asymptotic distribution. The predicted peak gusts were then converted to the 1-minute and 10-minute wind speeds. The predicted gusts for the 2-year, 5-year, 10-year and 25-year events are 23.7, 29.9, 34.2 and 39.5 m/s, respectively. Corresponding 1-minute wind speeds are 19.5, 24.6, 28.2 and 32.5 m/s, and 10-minute speeds are 15.7, 19.8, 22.6 and 26.1 m/s. The results are summarized in Table 4.

During Hurricane 'Iwa in November 1982, the peak gust recorded at MCBH was 80 knots (41.2 m/s), which was greater than the predicted 25-year peak gust. During Hurricane Iniki in

September 1992 the peak gust was 55 knots (28.3 m/s), approximately the same as the predicted 5-year peak gust.

2.6 Tsunamis

The Hawaiian Islands have a history of destructive tsunamis. Since 1819, 22 severe tsunamis have occurred, with wave heights ranging from 4 to 60 feet. The resultant tsunami wave height at the Hawaii coastline during a given occurrence varies greatly with location. The height is affected by a number of factors including offshore bathymetry, coastal configuration and exposure to the generating area. In 1978, M&E Pacific, Inc. prepared a manual for determining tsunami wave elevations along the coastline of Hawaii for various frequencies of occurrence. This manual has become the accepted standard, and the methods described in the manual have been used to develop the Flood Insurance Rate Maps for the state. The predicted 10-year height for the project area is 2.5 feet above mean sea level, at a point 200 feet inland of the coastline. The calculated 25-year height is 6.8 feet. There is no record of bore formation in this area of Oahu, so a tsunami wave can be expected to take a form of a rapidly rising and falling tide, with a wave period of approximately 10 to 15 minutes.

2.7 Waves

The Hawaiian wave climate can be described by four primary wave types: northeast tradewind waves, North Pacific swell, south swell and Kona storm waves. The project area is completely sheltered from south swell and Kona storm waves by the island of Oahu itself.

Northeast tradewind waves are present in Hawaiian waters throughout the year, but are most frequent in summer months, when they usually dominate the Hawaiian wave climate. They result from the strong and steady tradewinds blowing from the northeast quadrant over long fetches of open ocean. Typical deepwater tradewind waves have periods of 5 to 8 seconds and heights of 1 to 3 m.

North Pacific swell is produced by severe winter storms in the Aleutian area of the North Pacific and by mid-latitude low-pressure systems. North swell may arrive in Hawaiian waters throughout the year, but it is largest and most frequent during the winter months of October through March. The North Pacific swell approaches from the sector west through north, with periods of 13 to 20 seconds and typical deepwater heights of 1.5 to 3 m. Breaking wave heights of 6 m or more occur annually on exposed shorelines. The project site is partially sheltered from the approach of North Pacific swell, and only the more northerly of these swells influence the area.

In addition to the two primary wave types, infrequent tropical cyclones may generate large waves, and these can impact any coastal area of Hawaii.

The Scripps Institution of Oceanography has been collecting wave data since August 9, 2000 from a directional wave rider buoy deployed 4.5 miles southeast of Mokuapu Point, Oahu (Figure 1). The buoy is located at 21°24.9'N and 157°40.7'W in a water depth of 100 meters. This buoy provides wave data directly applicable to the project site, since the exposure at the two sites is the same. The information obtained therefore provides an excellent source of data for this

project. The analysis summarized in this report is based upon data collected for the 10-month period between August 2000 and June 2001. The buoy is still in place and data collection is still continuing.

Tables 5 gives the annual percent frequency distribution for waves measured at the buoy location. The wave heights in the table are the significant wave heights, which are defined as the average of the highest one-third of the waves. The significant wave height generally corresponds to the height that would be recorded by a visual observer.

Wave periods during the 10-month measurement period ranged from 4.0 to 22.2 seconds. The largest wave height of 4.5 m was recorded in August. Approximately 90 percent of waves had a wave period less than 12 seconds, indicating almost 90 percent of reported waves were locally generated wind waves and only 10 percent were swell.

Sea Engineering, Inc. (2001) theoretically transformed the deepwater information to a data set in a water depth of 100 feet (30m) (the estimated buoy location) by applying wave shoaling based on linear wave theory. Since the exact WEC buoy location was not known at that time and the data was for planning purposes only, refraction and diffraction effects were not included in the analysis. The results for the annual wave occurrences are presented in Table 6. The largest significant wave height at the 100-foot (30m) water depth for the ten-month period was calculated to be 4.2 m. However, it should be noted that the period of record did not include a severe storm or a major hurricane. The largest waves occurred in February and August with wave periods ranging from 8 to 10 seconds. The period indicates that these waves were probably generated by strong tradewinds. In general, the winter months had larger waves with longer periods, indicative of the presence of north Pacific swell.

While the buoy data is directly applicable for the assessment of the operational conditions at the site, additional analyses are required to determine the design wave conditions. Extreme waves at the site can be generated from three sources; North Pacific swell, strong trade winds and passing hurricanes.

North Pacific Swell

Although the short record from the buoy is not sufficient to accurately predict long-term wave heights, the data can be extrapolated to provide an estimate of swell heights for given return periods. Waves with a period greater than 12 seconds were selected for the swell analysis.

To evaluate the probability of occurrence of severe swell conditions, a cumulative probability function was developed. Details are provided in the 2001 Sea Engineering, Inc. report. The results are summarized in Table 7 for a risk of exceedence of 30%. The predicted swell heights for the 2-year, 5-year, 10-year and 25-year return periods are 3.7, 3.9, 4.0 and 4.2 m, respectively. The periods for these waves can be expected to range from 12 to 24 seconds.

Corresponding swell heights versus return periods at the 30-m water depth were similarly determined, and the results are summarized in Table 8. In 30 meters of water, swell heights of 3.7, 3.9, 4.1 and 4.3m correspond to 2, 5, 10 and 25-year return periods, respectively. The wave heights in 30 m of water are very similar to heights at the wave buoy site.

Wind Waves

Extreme wind waves were estimated using the same method. Waves with a period less than 14 seconds were defined as wind waves. The predicted wind wave heights for the 2-year, 5-year, 10-year and 25 year return periods are 4.5, 4.8, 5.0 and 5.3 m, respectively. Corresponding wave heights at a water depth of 30 meters are 4.1, 4.3, 4.5 and 4.8 m, slightly smaller than the wave heights at the directional buoy. Analysis results are summarized in Tables 9 and 10. Again, it should be noted that these results are based upon a short record period, and provide only an estimate of extreme conditions.

Hurricane Waves

In any given year, one or more hurricanes can be expected to occur in the central North Pacific Ocean. Although hurricanes occur infrequently in the immediate vicinity of Hawaii, they do occasionally pass near the islands. Notable recent examples are Hurricane Iwa, which passed within 30 miles of Kauai in 1982, and Hurricane Iniki, which passed directly over Kauai in 1992. Because hurricanes directly impact the Hawaiian Islands at such infrequent intervals, there is no realistic method to calculate a return period.

Wave hindcasts of Hurricanes Iwa and Iniki indicated that the waves generated approached from the sector southeast through west. The project site was therefore relatively sheltered from severe waves during the two hurricanes.

Storms with hurricane intensity rarely pass directly north of the Hawaiian Islands, as illustrated by Figure 2. The most recent historical hurricane passing north of the islands was Hurricane Hiki in 1950.

In order to evaluate a direct hurricane wave attack in the project area, a Hawaiian scenario hurricane was used, as defined in the report *Hurricanes in Hawaii* (Haraguchi, 1984) prepared for the U.S. Army Corps of Engineers following Hurricane Iwa. The model hurricane is defined as the probable hurricane that will strike the islands, and is based on the characteristics of hurricanes Dot (1959) and Iwa (1982), both of which impacted the islands. For this project, the approach direction was assumed to be from the sector east through southeast. The results indicated that the largest deepwater significant wave height off the project site would be 8.4 m with a significant wave period of 11.5 seconds. The resultant significant wave height in 30 m of water was calculated to be 7.7 m.

The single maximum wave that would be present during the model hurricane was calculated using methodology described by Bretschneider (1973). The calculated maximum deepwater wave height was 14.9 m, and the associated maximum height in 30 m of water was 13.6 m. Hurricane wave conditions are summarized in Table 11.

Table 1. Annual Percent Frequency Distribution for Winds at Kaneohe Bay MCAS

STATION : KANEOHE BAY MCAS ,HI,US
 LOCATION: LAT 21 27N, LONG 157 47W, ELEV 6(m)

16 PT. DIR.	PERCENT FREQUENCY (%) (1945 - 1995)											TOTAL	MEAN
	1 - 3	4 - 6	7-10	11-16	17-21	22-27	28-33	34-40	41-47	48-55	>=56		
N	.3	.9	1.0	.6	.1	*	0	0	0	0	0	2.8	7.8
NNE	.5	1.8	3.3	1.7	.2	*	*	0	0	0	0	7.5	8.5
NE	.7	3.0	7.2	5.5	.5	.1	*	0	0	0	0	17.5	9.5
ENE	1.0	4.7	11.8	11.4	1.4	.1	*	0	0	0	0	30.5	10.1
E	.7	2.9	6.9	6.9	.9	.1	*	0	0	0	0	17.9	10.1
ESE	.3	.8	1.8	1.7	.2	*	*	0	0	0	0	5.1	9.8
SE	.2	.4	.3	.1	*	*	0	0	0	0	0	1.1	7.2
SSE	.4	.4	.3	.1	*	*	*	0	0	0	0	1.2	6.3
S	.9	.7	.4	.2	.1	*	*	*	0	0	0	2.2	5.5
SSW	.9	.7	.4	.2	.1	*	*	*	0	0	0	2.4	6.2
SW	.7	.5	.3	.2	*	*	*	*	0	0	0	1.9	6.2
WSW	.6	.4	.2	.1	*	*	*	*	0	0	0	1.3	5.4
W	.4	.4	.2	.1	*	*	*	*	0	0	0	1.1	4.6
WNW	.2	.3	.2	.1	*	*	*	*	0	0	0	.8	5.9
NW	.2	.3	.2	.1	*	*	0	0	0	0	0	.9	7.8
NNW	.2	.5	.4	.3	.1	*	*	0	0	0	0	1.6	8.5
VAR	0	0	0	0	0	0	0	0	0	0	0	0	0
CLM	0	0	0	0	0	0	0	0	0	0	0	4.6	0
TOTAL	8.4	18.8	34.6	29.3	3.8	.4	*	*	*	0	0	100	8.8

* = PERCENT < .05
 # = EXCESSIVE MISSING DATA - VALUE NOT COMPUTED
 THE TOTAL NUMBER OF DATA = 128321

Table 2. Monthly Peak Gust (Knots) At Kaneohe Bay MCAS

STATION : KANEOHE BAY MCAS ,HI,US
 LOCATION: LAT 21 27N, LONG 157 47W, ELEV 6(m)

YEAR	JAN	FEB	MAR	APR	MAY	JUN	JUL	AUG	SEP	OCT	NOV	DEC	ANNUAL
1948	53*	35E	42E	36*	36*	31E	37*	32E	33E	-	40E	42E	53*
1949	53SW	36*	36E	33*	-	-	-	-	-	-	-	-	-
1950	-	-	-	-	-	-	-	-	-	-	-	-	-
1951	-	-	-	-	-	-	-	-	-	-	-	-	-
1952	-	-	-	-	-	-	24E	23ENE	29ENE	25NNE	35NE	34VAR	-
1953	32SW	36E	33ENE	34NW	-	-	30SE	30ENE	32*	36ENE	37ENE	37E	37*
1954	61SSW	52N	51NNE	52SSW	38*	-	-	32*	35*	37*	47*	51*	61*
1955	57*	42SSE	39*	40*	32*	32*	35*	34*	-	-	-	-	-
1956	-	-	-	-	-	-	-	-	-	-	-	-	-
1957	-	-	-	-	-	-	-	-	28*	43SSW	41ESE	-	-
1958	33NNW	36SSW	30*	33*	29ENE	31ENE	38E	46*	29*	-	-	-	46*
1959	-	-	-	-	33ENE	30*	31E	43SE	29E	26E	39NE	40NE	43*
1960	45ENE	39N	33*	29E	31ENE	29E	28NE	28E	34E	28ENE	30*	29NNE	45*
1961	36*	36E	37E	36ESE	30E	36ESE	40E	37E	30E	36*	39NE	30E	40*
1962	43SSW	32NNW	34*	28E	29ENE	27ENE	28ENE	26ENE	27ENE	34E	31ENE	32WSW	43*
1963	73SW	65SW	41NW	34NE	30NNE	31ENE	28ENE	24ENE	32E	26NE	26ENE	34NNW	73SW
1964	30NE	33NE	30*	32*	29ENE	32NE	28NE	28ENE	32NNE	35NE	56S	56*	-
1965	32*	-	-	-	-	-	-	-	-	-	-	-	-
1966	-	-	-	-	-	-	-	-	-	-	-	-	-
1967	-	-	-	-	-	-	-	-	-	-	-	-	-
1968	-	-	-	-	-	-	-	28*	23E	20*	37NNE	36NW	-
1969	40S	35NE	28NE	33NE	31NE	25NE	30NE	27NE	25*	25ENE	32NE	41NNW	41*
1970	83SSW	35NNW	31NE	28NE	29NE	28NE	30NE	25NE	26NE	30NE	29SW	35NE	83SSW
1971	55S	36NE	35S	30NE	25*	24NE	28NE	26NE	26ENE	27NE	32*	35ENE	55*
1972	28ESE	45*	37S	29ENE	26NNE	28NE	29E	27NE	33ENE	25E	31E	32SSW	45*
1973	29ENE	27NNE	32E	33E	28ESE	31E	31E	29E	27ENE	27E	29ENE	32W	33E
1974	44WSW	26ENE	44WSW	32E	27E	25E	27E	28E	28SE	27ENE	29NNW	31E	44WSW
1975	33ENE	28NE	30NNW	32ENE	29ESE	29E	25ENE	26ENE	28E	27ESE	30S	-	33*
1976	24*	47*	32*	31*	26*	29*	24*	-	23*	31*	25*	47*	-
1977	31*	25*	33*	27ENE	29*	27*	29*	26*	27ENE	34NE	32E	33WSW	34*
1978	33*	25N	27W	29E	28ESE	31E	27E	25ESE	27E	25NNE	29N	34E	34*
1979	40SW	41SSW	33WNW	29E	27E	28E	27ENE	24E	26E	29E	30N	37W	41SSW
1980	68SW	38N	38E	30E	26E	28E	28E	25E	27E	34E	28E	35NW	68SW
1981	34WSW	52SW	30E	28*	30*	29ENE	28E	26E	27ENE	37E	35E	37W	52*
1982	48WSW	54WSW	30ENE	24E	27*	24E	27E	35E	32E	30E	80SSW	29NE	80*
1983	32WSW	30WSW	31WSW	32E	28ENE	30NE	33*	28E	26E	24E	26E	34WSW	34*
1984	25?	26?	37?	33?	28?	28NNE	26?	25?	25?	23?	30?	35?	37?
1985	55?	43?	32?	24?	27?	23?	27?	25?	-	-	33*	34N	55*
1986	-	41?	27?	32?	24?	25?	26?	24?	21?	-	33ESE	49?	49*
1987	34?	33?	33?	33?	27?	27?	26?	24?	24?	22?	27?	32?	34?
1988	31?	26?	27?	26?	24?	30?	28?	28?	25?	22?	36NNW	41?	41?
1989	30?	38?	54?	31?	25?	24?	31?	35?	27?	24?	-	28ESE	54*
1990	27?	37?	29?	23*	28?	25?	24?	24?	24*	29*	-	-	37*
1991	-	-	-	-	22*	23?	21*	32?	30?	22NNW	26?	29?	-
1992	37?	33?	26?	20?	30NE	28?	23?	34?	55?	22?	33?	32?	55?
1993	48?	33ESE	36?	24?	25?	25?	33?	23?	27?	28ENE	29?	31?	48?
1994	28?	24?	35?	25?	24?	23?	24?	27?	23?	24?	29?	32?	35?
1995	42?	33?	39?	29?	29?	22?	24?	23?	20?	24?	29?	34ESE	42?
MEAN	42.0	36.4	34.7	30.3	27.7	27.5	28.3	27.8	28.2	27.3	33.6	35.2	48.8
STDV	14.6	9.0	6.7	5.5	2.3	3.2	3.6	4.5	5.8	4.3	9.5	5.7	16.2
#OBS	30	33	30	29	28	32	32	34	32	30	32	35	13

@ = Maximum 1 - Minute Speed (For Forieg Stations)
 * = INCOMPLETE
 - = MISSING DATA
 ? = UNKNOWN WIND DIRECTION
 # = EXCESSIVE MISSING DATA - VALUE NOT COMPUTED

**Table 3. Monthly Wind Conditions At Kaneohe Bay MCAS
 (Data Period: 1945 – 1995)**

Month	Most Freq. Direction (Dir./ %)	Average Wind Speed (m/s)	Maximum Peak Gust (m/s, (knts))	Estimated Max. Speed (m/s)	
				1-Minute Speed	10-Minute Speed
January	ENE (14)	7.7	42.7 (83)	35.2	28.2
February	ENE (17)	8.1	33.5 (65)	27.6	22.2
March	ENE (26)	9.3	27.8 (54)	22.9	18.4
April	ENE (32)	9.6	26.8 (52)	22.1	17.7
May	ENE (38)	9.2	19.6 (38)	16.2	13.0
June	ENE (38)	9.4	18.5 (36)	15.2	12.2
July	ENE (42)	9.6	20.6 (40)	17.0	13.6
August	ENE (41)	9.4	23.7 (46)	19.5	15.7
September	ENE (35)	8.3	28.3 (55)	23.3	18.7
October	ENE (29)	8.0	19.0 (37)	15.7	12.6
November	ENE (29)	8.5	41.2 (80)	33.9	27.2
December	ENE (24)	8.3	28.8 (56)	23.7	19.0
Overall	ENE (31)	8.8	42.7 (83)	35.2	28.2

Table 4. Return Periods Versus Wind Speeds

Return Period (years)	Peak Gust (m/s (knts))	1-Minute Wind Speed (m/s)	10-minute Wind Speed (m/s)
2	23.7 (46.0)	19.5	15.7
5	29.9 (58.1)	24.6	19.8
10	34.2 (66.4)	28.2	22.6
25	39.5 (76.8)	32.5	26.1

Table 5. Annual Percent Frequency Distribution For Waves At The Mokapu Point Buoy

SITE : MOKAPU POINT BUOY
 WATER DEPTH: 100 METERS MLLW

HEIGHT (MTRS)	PERCENT FREQUENCY (%) (8/9/00 - 6/13/01)												TOTAL
	2.0- 4.0	4.0- 6.0	6.0- 8.0	8.0-10.0	10.0-12.0	12.0-14.0	14.0-16.0	16.0-18.0	18.0-20.0	20.0-22.0	22.0-24.0		
0.0- 0.3	0.00	0.00	0.00	0.00	0.00	0.00	0.00	0.00	0.00	0.00	0.00	0.00	0.00
0.3- 0.6	0.00	0.00	0.00	0.00	0.00	0.00	0.00	0.00	0.00	0.00	0.00	0.00	0.00
0.6- 0.9	0.00	0.00	0.36	0.05	0.00	0.00	0.00	0.00	0.00	0.00	0.00	0.00	0.41
0.9- 1.2	0.00	0.25	2.44	1.97	0.58	0.26	0.11	0.03	0.00	0.00	0.00	0.00	5.64
1.2- 1.5	0.00	2.54	4.86	5.14	2.61	1.19	0.38	0.11	0.06	0.02	0.01	0.01	16.92
1.5- 1.8	0.00	2.81	5.75	8.61	2.48	1.19	0.54	0.10	0.13	0.02	0.00	0.00	21.63
1.8- 2.1	0.00	1.51	6.34	8.54	2.17	0.70	0.61	0.25	0.14	0.01	0.00	0.00	20.28
2.1- 2.4	0.00	0.20	5.22	6.67	1.22	0.38	0.78	0.20	0.14	0.00	0.00	0.00	14.82
2.4- 2.7	0.00	0.07	2.97	4.59	1.34	0.25	0.49	0.24	0.06	0.00	0.00	0.00	10.01
2.7- 3.0	0.00	0.00	0.92	2.87	1.22	0.20	0.13	0.11	0.00	0.00	0.00	0.00	5.45
3.0- 3.3	0.00	0.00	0.20	1.29	1.19	0.09	0.01	0.00	0.00	0.00	0.00	0.00	2.80
3.3- 3.6	0.00	0.00	0.05	0.59	0.63	0.02	0.00	0.00	0.00	0.00	0.00	0.00	1.29
3.6- 3.9	0.00	0.00	0.02	0.24	0.21	0.00	0.00	0.00	0.00	0.00	0.00	0.00	0.47
3.9- 4.2	0.00	0.00	0.00	0.09	0.07	0.00	0.00	0.00	0.00	0.00	0.00	0.00	0.16
4.2- 4.5	0.00	0.00	0.00	0.08	0.02	0.00	0.00	0.00	0.00	0.00	0.00	0.00	0.11
TOTAL	0.00	7.38	29.15	40.75	13.73	4.29	3.06	1.06	0.52	0.06	0.01	0.01	100.00

THE TOTAL NUMBER OF DATA = 14156
 THE RANGE OF WAVE HEIGHTS (MTRS) : 0.66 - 4.49
 THE RANGE OF WAVE PERIODS (SEC.) : 4.0 - 22.2

THE WAVE HEIGHT IS THE SPECTRALLY BASED SIGNIFICANT WAVE HEIGHT.
 THE WAVE PERIOD IS THE PERIOD ASSOCIATED WITH THE SPECTRAL PEAK.

Table 6. Annual Percent Frequency Distribution For Waves At The Water Depth Of 30 Meters

SITE : KANEHOE BAY MCAS
 WATER DEPTH: 30 METERS MLLW

HEIGHT (MTRS)	PERCENT FREQUENCY (%) (8/9/00 - 6/13/01)												TOTAL
	2.0- 4.0	4.0- 6.0	6.0- 8.0	8.0-10.0	10.0-12.0	12.0-14.0	14.0-16.0	16.0-18.0	18.0-20.0	20.0-22.0	22.0-24.0		
0.0- 0.3	0.00	0.00	0.00	0.00	0.00	0.00	0.00	0.00	0.00	0.00	0.00	0.00	0.00
0.3- 0.6	0.00	0.00	0.00	0.00	0.00	0.00	0.00	0.00	0.00	0.00	0.00	0.00	0.00
0.6- 0.9	0.00	0.00	0.00	0.49	0.23	0.05	0.01	0.01	0.00	0.00	0.00	0.00	0.78
0.9- 1.2	0.00	0.25	2.88	3.06	1.29	0.42	0.11	0.03	0.00	0.00	0.00	0.00	8.05
1.2- 1.5	0.00	2.67	5.10	6.24	2.78	1.36	0.41	0.08	0.02	0.00	0.00	0.00	18.66
1.5- 1.8	0.00	2.82	6.24	10.33	2.88	1.19	0.54	0.11	0.09	0.04	0.01	0.01	24.24
1.8- 2.1	0.00	1.40	6.20	8.36	1.66	0.54	0.66	0.22	0.14	0.01	0.00	0.00	19.19
2.1- 2.4	0.00	0.18	5.06	5.71	1.38	0.27	0.69	0.20	0.11	0.01	0.00	0.00	13.61
2.4- 2.7	0.00	0.06	2.44	3.86	1.25	0.28	0.52	0.23	0.12	0.00	0.00	0.00	8.77
2.7- 3.0	0.00	0.00	0.53	1.75	1.43	0.17	0.11	0.15	0.04	0.00	0.00	0.00	4.17
3.0- 3.3	0.00	0.00	0.14	0.73	0.72	0.04	0.01	0.06	0.00	0.00	0.00	0.00	1.70
3.3- 3.6	0.00	0.00	0.05	0.29	0.21	0.00	0.00	0.00	0.00	0.00	0.00	0.00	0.55
3.6- 3.9	0.00	0.00	0.00	0.11	0.09	0.00	0.00	0.00	0.00	0.00	0.00	0.00	0.20
3.9- 4.2	0.00	0.00	0.00	0.08	0.00	0.00	0.00	0.00	0.00	0.00	0.00	0.00	0.08
TOTAL	0.00	7.38	29.15	40.75	13.73	4.29	3.06	1.06	0.52	0.06	0.01	0.01	100.00

THE TOTAL NUMBER OF DATA = 14156
 THE RANGE OF WAVE HEIGHTS (MTRS) : 0.62 - 4.16
 THE RANGE OF WAVE PERIODS (SEC.) : 4.0 - 22.2

THE WAVE HEIGHT IS THE SPECTRALLY BASED SIGNIFICANT WAVE HEIGHT.
 THE WAVE PERIOD IS THE PERIOD ASSOCIATED WITH THE SPECTRAL PEAK.

Table 7. Return Periods Versus Swell Heights at the Wave Buoy

Return Period (years)	Wave Height (meters)
2	3.7
5	3.9
10	4.0
25	4.2

Table 8. Return Periods Versus Swell Heights At The Water Depth Of 30 Meters

Return Period (years)	Wave Height (meters)
2	3.7
5	3.9
10	4.1
25	4.3

Table 9. Return Periods Versus Wind Wave Heights At The Wave Buoy

Return Period (years)	Wave Height (meters)
2	4.5
5	4.8
10	5.0
25	5.3

Table 10. Return Periods Versus Wind Wave Heights at the Water Depth of 30 Meters

Return Period (years)	Wave Height (meters)
2	4.1
5	4.3
10	4.5
25	4.8

Table 11. Summary Of Hindcast Hurricane Wave Conditions

	Model Hurricane
Wave Period	
Significant Wave Period (sec.)	11.5
Average Wave Period (sec.)	8.0
Deepwater Wave Height	
Significant Wave (m)	8.4
Maximum Wave (m)	14.9
Wave Height at 30-Meter Water Depth	
Significant Wave (m)	7.7
Significant Wave Crest Elevation (m)	4.5
Maximum Wave (m)	13.6
Maximum Wave Crest Elevation (m)	9.8

3 IMPACT ASSESSMENT

3.1 Impacts During Construction

Installation of the buoy, buoy anchors and cable will require a variety of workboats and possibly barges. All vessels are required to follow USCG regulation regarding the release or spilling of petroleum products at sea.

The main anchor will be a steel shell containing ___ tons of concrete blocks. The total buoy anchor weight will be ___ tons. Placement of the main buoy anchor will be seaward of the 95-foot contour, on an area with no ledges and little biological diversity. The buoy and anchor installation plan has not been finalized at this time. If anchoring is required, a possible impact could be damage to the bottom due to anchoring. Anchoring a barge or a workboat will probably require a three or four point mooring.

The bottom in the area is hard limestone with possibly a thin veneer of sand. Buoy installation and anchoring should cause no increase in turbidity in the water column.

The cable route avoids areas of high relief to the maximum extent possible. There will be some areas of 3-foot relief that have to be crossed in the zone between the 35 and 15-foot water depths. Several days of investigations have been completed to pick the best route through this zone. On the day prior to the cable installation, a small (3/16") galvanized wire will be pre-laid along the desired route. During the installation the laying vessel will be equipped with differential GPS. The helmsman will have the advantage of a computer screen that shows the desired route as well as the actual vessel position. In addition, divers will spot check the cable the position of the cable as it is laid through this zone. This exact procedure was used very successfully to place two fiber optic cables in the sand channel off Spencer Beach Park on the island of Hawaii. Coral outcrops in a narrow winding channel were marked and avoided during the installation

Cable bridging and spanning across high points will be minimized by controlling cable tension. A linear cable engine with preset tension will be used during the installation.

No excavation of the shoreline or the shore/water interface will be required for the cable installation. The cable will cross the east end of the rock revetment, and will therefore be separated from the beach. There will be no impact to the beach during the installation or operation of this system.

3.2 Operational Impacts

Movement of the main buoy anchor, the secondary anchors, or the power cable has the potential to damage the benthic environment, including corals. The main buoy anchor is designed to lift and move slightly under severe wave conditions. This movement is limited by the secondary anchors, which will be a four point mooring for each main buoy anchor. Due to the potential movement of the main anchor, organisms beneath and in the immediate vicinity of the anchor may be destroyed. However, the anchor site has little benthic diversity. The secondary anchors

will not move, but the chains connecting them to the main anchor will move and abrade the bottom over a limited area.

The power cable will be anchored along its entire length by either rock bolts or protective split pipe. The anchoring design is being completed, and the weight and spacing of the anchors will be such that the cable will not move under design wave conditions. Wave forces on the cable are being calculated to determine the anchor spacing.

The entire buoy, anchor and cable system is designed to resist a design scenarios hurricane. The occurrence of waves on the windward side of the island associated with such an event is highly unlikely.

The working fluid for the buoy's power generating system will be a "green", or biodegradable hydraulic fluid.

4 PHOTO LOG

Photo #	Water Depth, ft	Description
1	n/a	Aerial photo showing protective revetment and the west end of the beach.
2	n/a	View of beach just east of proposed cable landing point.
3,4,5	n/a	Shoreline conditions at east end of North Beach, fronting the military housing.
6	30	Typical spur and groove formation in 30 feet of water.
7,8	50	Typical bottom conditions in the 30 to 50-foot deep zone.
9,10	100	Typical bottom conditions at the 100-foot water depth
11	35	Flat bottom, typical of the 35 to 50 foot zone.
12	30	Typical channel formation, which narrows and then is partially blocked by section of a higher ridge.
13	28	The channel narrows and becomes meandering, and it would not be possible for the cable to follow the channel through this area. Photo 5 shows the transition from the channel to an area of raised limestone bottom. The bottom through this area is limestone, with scattered coral, and vertical relief of approximately two feet.
14	28	Typical conditions on raised limestone ridge. The bottom through this 225 foot long area is limestone, with scattered coral and vertical relief of approximately two feet.
15	22	A three-foot rise onto a higher ridge section is visible in the background. The cable will cross approximately 25 feet of this ridge.
16	19	Photo 16 shows the seaward end of the sand deposit, which has numerous limestone outcrops. The cable will be oriented in this area to avoid the areas with the most pronounced vertical relief.
17	16	Limestone outcrop protruding above sand deposit. Sand thickness at this point is six inches. The sand thickness increases to two feet over the next fifty feet.
18	15	Small limestone outcrop protruding above the sand, with the inshore end of the sand deposit clearly visible in the background. Sand thickness at this point is 0.2 feet.
19	13	Typical conditions on top of outcrop. Limestone has little coral coverage, probably due to sand abrasion during wave events.
20	11	Low-relief limestone outcrops. There appears to be a significant amount of onshore-offshore sand transport, and these outcrops may be seasonally buried.
21	11	Typical conditions in nearshore sand deposit. The bottom in this area is predominantly sand with thickness of three feet or more, but limestone outcrops, such as the one shown in the photo, are widely scattered throughout the area.
22	4	This photo, which was taken approximately 50 feet offshore, shows basalt boulders which have been moved from the runway revetment by wave action. The boulders are now loosely scattered along the bottom just seaward of the revetment. This boulder field is approximately 150 feet wide in the vicinity of the selected cable landing point.

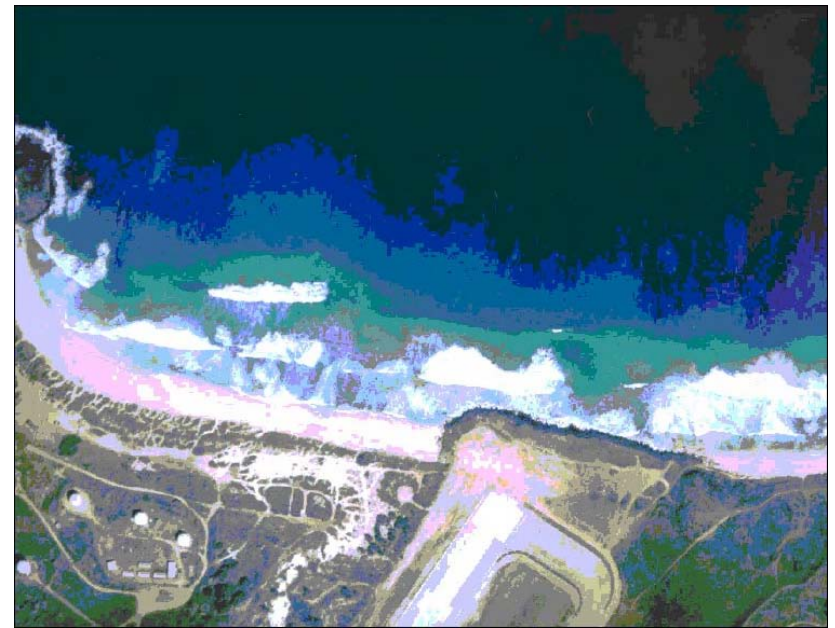

Photo 1



Photo 2



Photo 5



Photo 6



Photo 3



Photo 4



Photo 7



Photo 8

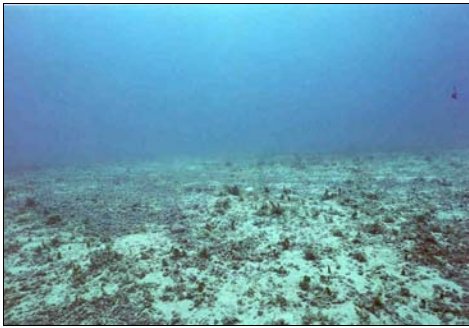

Photo 9

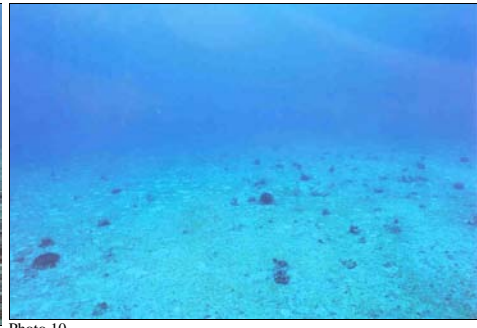

Photo 10



Photo 11



Photo 12



Photo 13

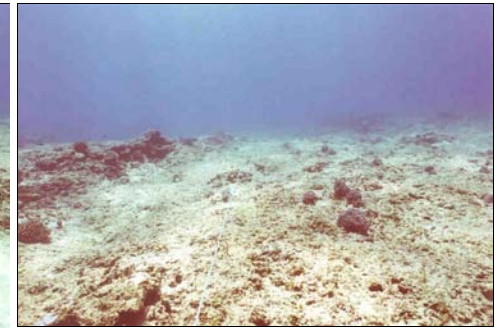

Photo 14

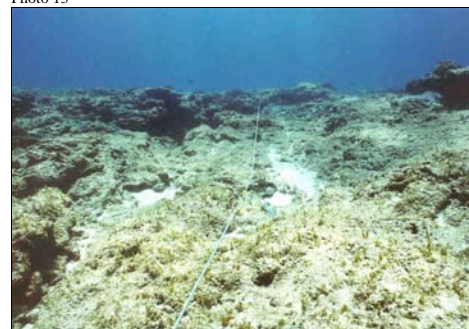

Photo 15



Photo 16

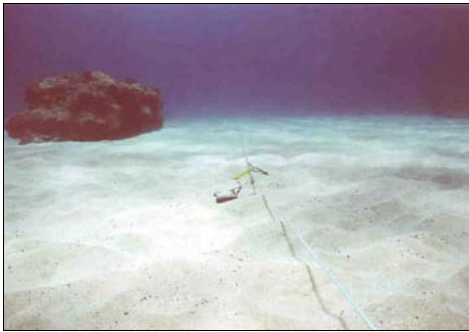

Photo 17



Photo 18



Photo 21



Photo 22



Photo 19

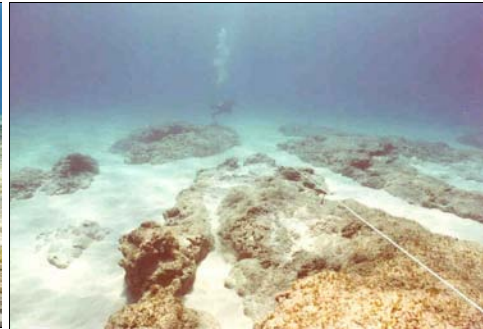

Photo 20

5 REFERENCES

- AECOS, 1979. *Hawaii Coral Reef Inventory, Island of Oahu*. Prepared for the U.S. Army Engineer District, Honolulu.
- Bathen, K.H., 1978. *Circulation Atlas for Oahu, Hawaii*. Sea Grant Miscellaneous Report, UNIHI-SEAGRANT-MR-78-05
- Bretschneider, C.L., 1973. *Design Hurricane Waves for the Island of Oahu, Hawaii, with Special Application to Sand Island Ocean Outfall System*. Look Lab/Hawaii, Vol. 3, No. 2, J.K.K. Look Lab., Univ. of Hawaii, Honolulu, Hawaii.
- Clark, J.R.K., 1977. *The Beaches of O'ahu*. University of Hawaii Press.
- Haraguchi, P., 1984. *Hurricanes in Hawaii*. Prepared for Department of the Army, Pacific Ocean Division, Corps of Engineers.
- Lighthouse Press, 2000. *Tide Tables 2001*.
- M&E Pacific, Inc. 1978. *Manual For Determining Tsunami Runup Profiles on Coastal Areas of Hawaii*, Prepared for Department of the Army, Pacific Ocean Division, Corps of Engineers.
- Sea Engineering, Inc., 1990. *Windward Oahu Hurricane Vulnerability Study, Determination of Coastal Inundation Limits*, Prepared for State of Hawaii Department of Defense and U.S. Army Corps of Engineers, Pacific Ocean Division.
- Sea Engineering, Inc., 2001. *Preliminary Site Investigation, Wave Power Demonstration Project, Marine Corps Base, Kaneohe, Oahu*. Prepared for Ocean Power Technologies, Inc.
- Sea Engineering, Inc., 2001. *Summary of Prevailing and Extreme Oceanographic Conditions, Marine Corps Base Hawaii*. Prepared for Ocean Power Technologies, Inc.
- Sea Engineering, Inc., 2002. *Cable Route Recommendations for Wave Energy Conversion Project, Marine Corps Base Hawaii*. Prepared for Ocean Power Technologies, Inc.
- U.S. Army Corps of Engineers, Coastal Engineering Research Center. 1984. *Shore Protection Manual*.

Appendix F

Wave Energy Technology (WET) Project Environmental
Impacts of Selected Components. July 2002.
Sound & Sea Technology.

Wave Energy Technology Project (WET) Environmental Impacts of Selected Components



Prepared for:

Belt Collins Hawai'i

August 23, 2002

Report 02-06

Table of Contents

1	INTRODUCTION.....	1
2	SUMMARY PROJECT DESCRIPTION.....	1
3	SITE DESCRIPTION	1
4	EXISTING CONDITIONS	3
5	WAVE ENERGY TECHNOLOGY CONVERSION SYSTEM OVERVIEW	3
5.1	WET Buoy	3
5.2	Anchor System	4
5.3	Equipment Canister	4
5.4	Undersea Transmission Cable	7
6	WEC TECHNOLOGY ELECTRIC AND MAGNETIC FIELD EFFECTS ON MARINE LIFE.....	8
6.1	Introduction	8
6.2	Wet Cable Magnetic And Electric Fields	8
6.3	Electroreception and Magnetoreception	11
6.3.1	Electroreception in fish.....	12
6.3.2	Electrical Field Impacts	14
6.3.3	Magnetoreception in Fish	15
6.3.4	Magnetic Field Impacts	17
6.4	Electrical Fault Impacts of WET Operation.....	18
6.4.1	WET Electrical Fault Protection System.....	18
6.4.2	Electrical Fault Significance Criteria	18
6.4.3	Electrical Fault Impacts	18
6.4.4	Electrical Fault Mitigation	19
7	BIOLOGICAL ASSESSMENT OF NOISE IMPACTS FROM THE WET PROJECT	19
7.1	Introduction	19
7.2	WET Generator System Design.....	20
7.3	Acoustic terminology and relevant concepts	20
7.4	Ambient noise	21
7.5	WET PROJECT NOISE GENERATION.....	23
7.5.1	During Construction of WEC Arrays.....	24
7.5.2	During WET System Operation	25
7.6	Marine Vertebrates Commonly Occuring in Project Area	25
7.6.1	Ceteceans.....	25
7.6.1.1	Baleen Whales	26
7.6.1.2	Large Toothed Whales	26
7.6.1.3	Porpoises and Dolphins.....	26
7.6.2	Pinnipeds	30
7.6.3	Sea Turtles	30
7.7	SOUND PRODUCTION AND AUDITORY SENSITIVITY IN MARINE ANIMALS.....	31
7.7.1	Ceteceans.....	31
7.7.2	Pinnipeds – Hawaiian Monk Seal	33
7.7.3	sea turtles	34
7.7.4	Fish.....	34
7.8	Auditory Masking.....	34

7.9	Impacts of Anthropogenic Noise on Marine Animals.....	35
7.10	POTENTIAL IMPACTS OF NOISE FROM WAVE-ENERGY GENERATION SYSTEM ON MARINE ANIMALS.....	38
7.10.1	Construction Noise	38
7.10.2	Operating Noise	38
7.11	Conclusions	38
8	EFFECTS OF WET HEAT GENERATION.....	39
8.1	Ambient Conditions and WET Heat Sources.....	39
8.2	Significance Criteria.....	39
8.3	Power Cable	39
8.3.1	WET Power Cable Heat Generation and Dissipation.....	39
8.3.2	Impacts Due to Heat Dissipation.....	40
8.3.3	Issues	40
8.3.4	Impact Assessment	40
8.3.5	Mitigation	40
8.4	Equipment Canister	41
8.4.1	Equipment Canister Heat Generation and Dissipation	41
8.4.2	Issues	41
8.4.3	Impact Assessment	41
8.4.4	Mitigation	41
8.5	Load Resistors	42
8.5.1	Load Resistor Heat Generation and Dissipation.....	42
8.5.2	Issues	42
8.5.3	Impact Assessment	43
8.5.4	Mitigation	43
8.6	Hydraulic Fluid Heat Exchanger	43
8.6.1	Hydraulic Heat Exchanger Heat Generation and Dissipation.....	43
8.6.2	Issues	44
8.6.3	Impact Assessment	44
8.6.4	Mitigation	45
9	POTENTIAL FOR MARINE ANIMAL ENTANGLEMENTS OR OTHER INTERACTION WITH THE WET SYSTEM.....	45
9.1	Introduction	45
9.2	Review of Literature on Marine Mammal Entanglement.....	45
9.3	Modern Cable Installation	46
9.4	Assessment of Entanglement Risk for WET Cable.....	47
9.5	Mitigation	48
9.6	Interaction of other Marine Animals with the WET Equipment	48
9.6.1	Issues	48
9.6.2	Impact Assessment	48
9.6.3	Mitigation	49
10	LIST OF CONTRIBUTORS.....	49
11	REFERENCES.....	49

1 INTRODUCTION

Sound & Sea Technology (SST) was contracted by Belt Collins Hawai'i to conduct analyses of several aspects of the installation and operation of a Wave Energy Converter (WEC) technology developed by Ocean Power Technologies (OPT) off the coast of O'ahu, Hawai'i. The specific tasks assigned to SST included assessment of the potential environmental impacts due to the following aspects of the WEC equipment and installation:

1. Effects of electric and magnetic fields generated by the power cable on marine life
2. Effects of the acoustic signature of the in-water equipment on marine life
3. Effects of heating of the WEC power cable and other equipment
4. Potential for marine animal entanglement or interaction with the undersea cable and equipment during or after installation

Report figures and tables are numbered relative to their sections.

2 SUMMARY PROJECT DESCRIPTION

The Office of Naval Research (ONR) plans the phased installation of up to six Wave Energy Conversion power buoys in approximately 100 feet (29.5 meters [m]) of water off the coast of O'ahu, Hawai'i. The test site is off an area called North Beach at the Marine Corps Base Hawaii (MCBH)-Kaneohe Bay.¹ The proposed locations for the buoys are shown in Figure 2-1. The purpose of this test installation is to gather operational data to validate and demonstrate the WEC technology. The operational data will be used to verify the assumptions regarding survivability and maintainability of this technology.

3 SITE DESCRIPTION

The proposed site for installation of the WEC buoy system is bounded by the following coordinates:

	<u>Latitude</u>	<u>Longitude</u>
Lower Right Corner	21°27.875849'N	157°45.007140'W
Lower Left Corner	21°27.923971'N	157°45.139449'W
Upper Left Corner	21°27.997052'N	157°45.094704'W
Upper Left Corner	21°27.997052'N	157°45.094704'W
Upper Right Corner	21°27.956669'N	157°45.006450'W

The lower left and lower right corners are connected by the 90ft (27.5m) contour.

¹ North Beach, the MCBH Kaneohe Bay – the site of the proposed action – is one alternative considered as the test site for this project. The Pearl Harbor Site was evaluated as an alternate site to the proposed action. The specific tasks assigned to SST included assessment of the potential environmental impacts due to the aspects of the WEC equipment and installation. This assessment can be applied to either site location.

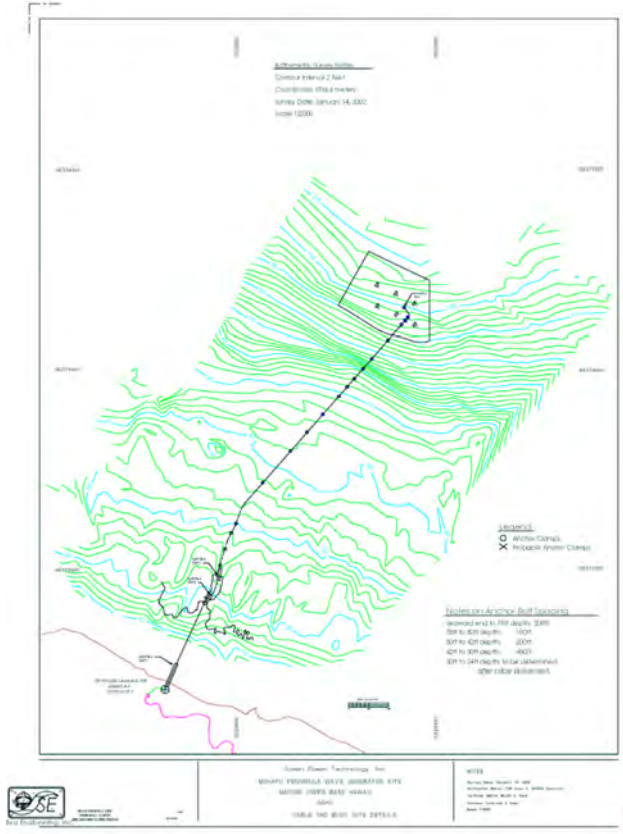

**Figure 3-1
Project Location**

4 EXISTING CONDITIONS

Existing conditions in the vicinity of the project site are described in detail in Henderson (1992) and Drigot, et al. (2001). The marine environment is diverse, with many species found seaward of the surf zone to the buoy installation site at about 100 ft (29m) water depth. Of specific interest are the species of protection concern. Four species of marine animals that have been listed as threatened or endangered are found in the vicinity of the project site. These include threatened green sea turtles (*Chelonia mydas*), endangered hawksbill turtles (*Eretmochelys imbricata*), the endangered Hawaiian monk seal (*Monachus schauinslandi*) and the endangered humpback whale (*Megaptera novaeangliae*).

Green sea turtles are common within MCBH Kaneohe Bay coastal waters near and off shore. They have been observed within a few feet of the shorebreak feeding on limu and or transitioning from one area to another. Green sea turtles have been observed as far as three miles to sea in MCBH Kaneohe Bay Coastal areas. Injured, sick, or dead Green sea turtles are recovered frequently from MCBH Kaneohe Bay coastal waters, sometimes as many as three in one month. Hawksbill turtles are observed or recovered infrequently.

Hawaiian monk seals are only rarely observed in the vicinity of the WET site. A female successfully gave birth near the Pyramid Rock beach cottages in 1996. There is an average of perhaps three sightings a year on the shoreline and in nearshore waters. When seals do haul out, it appears to be primarily for seeking a resting site.

During the mating and birthing seasons, humpback whales have been observed within 500 yard (460m) of the beach in large numbers weekly, with as many as 15 observed at one time. On occasion, they have also been observed in less than 15ft (4.6m) of water along the sandy coastal areas of MCBH (Makai). Three seasons ago a cow gave birth off North Beach, she has since returned each year with her calf. The proposed project site is in an area known to be frequented by humpback whales. Tail slapping and breaching behaviors are routinely observed in the general area of the project site.

5 WAVE ENERGY TECHNOLOGY CONVERSION SYSTEM OVERVIEW

Figure 5-1 shows a diagram of the offshore components of the WEC buoy conversion system. The system is comprised of the buoy, generator, equipment canister, anchor system, and undersea transmission cable. The buoy is designed to operate with the top of the buoy about one to four meters below the ocean surface. The buoy subsystem is anchored to the seafloor with a gravity anchor. A single buoy is designed to generate about 20 kilowatts (kW) average (40kW peak) of electricity. The power is transmitted to shore via an undersea electromechanical cable.

5.1 WET BUOY

The WEC buoy is a large cylindrical spar buoy, open at the bottom end, as shown in Figure 5-2. It is 15 ft (4.6m) in diameter, 50 ft (15.2m) long and weighs between 24 and 35 tons (22.5 to 32 tonnes), depending on details of the design. The unit is fabricated of steel with internal rib

stiffeners and stringers, with a buoyancy tank at the upper end. A shaft on which the buoy moves up and down in response to wave action occupies the center of the buoy.

The outer skin of the buoy is steel sheet. The interior structure is comprised of conventional round cross-section circumferential rib stiffeners (approximately 4 inches [100mm] in diameter) with round cross-section vertical stringers (approximately 3 inches [75mm] in diameter). Three-arm spider assemblies (arms are approximately 6 inches [150mm] in diameter) support the skin of the buoy at three locations and the buoy head assembly at the top of the buoy. The interior of the buoy is free of obstructions, sharp edges or corners. A universal joint allows motion of the buoy in two axes. The system creates an acoustic signature from the mechanical components. These factors are the subject of further discussion later in this report.

5.2 ANCHOR SYSTEM

A large gravity anchor restrains the buoy. The anchor is about 25ft by 26ft (7.6m by 7.9m). The anchor base is ringed by a flange frame and fixed to the seafloor by rock bolts to the seafloor. The weight of the anchor base is designed to prevent vertical movement of the base in design wave conditions and the rock bolts prevent horizontal movement under design wave conditions. The main gravity anchor and the rock bolts anchors are planned to be installed in an area that is not known to be habitat for any species of concern or live coral.

5.3 EQUIPMENT CANISTER

The equipment canister is a conventional design underwater pressure vessel that houses the hydraulic energy conversion system, the power conditioning and transmission equipment and the health-and-status monitoring system electronics. The canister is constructed of steel and plastics. It has no design or fabrication features that result in environmental issues. In operation, the hydraulic system generates heat that is dissipated to the surrounding seawater and results in some localized heating of the water. The generator contributes to the acoustic signature of the WEC system. The generator may create an electromagnetic field external to the buoy.

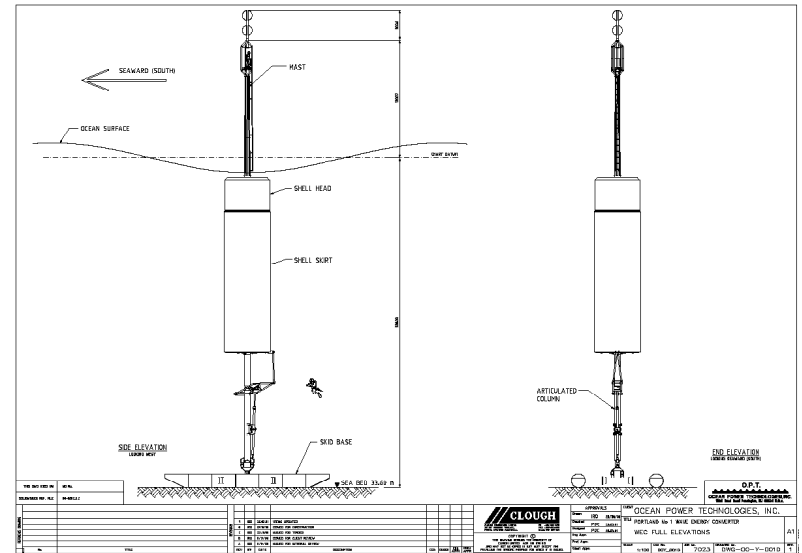

Figure 5-1
Wave Energy Technology Offshore Components

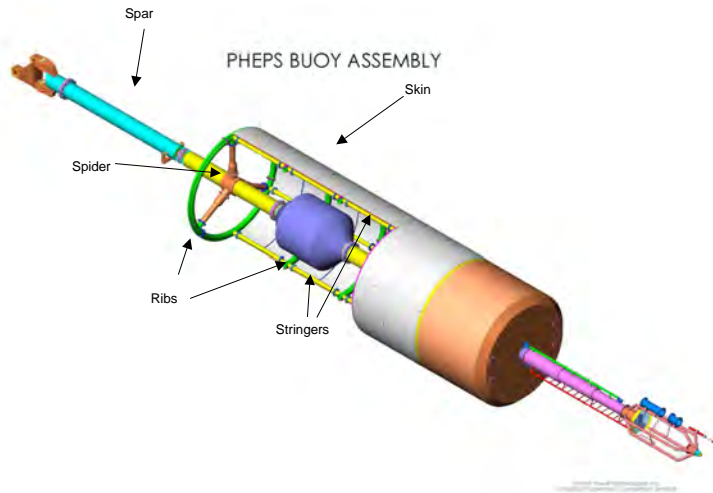

Figure 5-2
WEC Buoy

5.4 UNDERSEA TRANSMISSION CABLE

The WEC generator is housed in the equipment canister and is connected electrically to shore by an electromechanical cable approximately 3900 ft (1190 m) long. The baseline cable construction is shown in Figure 5-3. The cable is approximately 2.6 in (65.3 mm) in diameter. The cable is composite construction, with three helically wound copper conductors, designed for three-phase ac transmission at 3.8/6.6 kilovolts (kV). The cable is designed to carry up to 250kW. Each stranded copper conductor is insulated with a thermosetting dielectric based on an ethylene-propylene rubber elastomer. A semi-conductive screen is extruded over the insulation. Two optical fibers are laid in the interstices of the conductors; an inert filler rod is laid into the remaining interstice. The cable is brought to a circular configuration with polyethylene insulation. A nonmagnetic metallic sheath provides additional physical protection and electromagnetic screening. A layer of brass tape protects the cable against marine boring organisms, if this is determined to be required. The cable is then surrounded by one or two layers of helically wound galvanized steel wire armoring. An external jacket of high-density polyethylene completes the construction. All of the materials in the cable are non-toxic or inert. The cable is installed on the surface of the seafloor and is not buried. If required, the shore end can be stabilized by direct anchoring to the seafloor or by covering it with a concrete mattress to prevent movement due to wave action. The shore end will be encased in split pipe of a length to be determined.

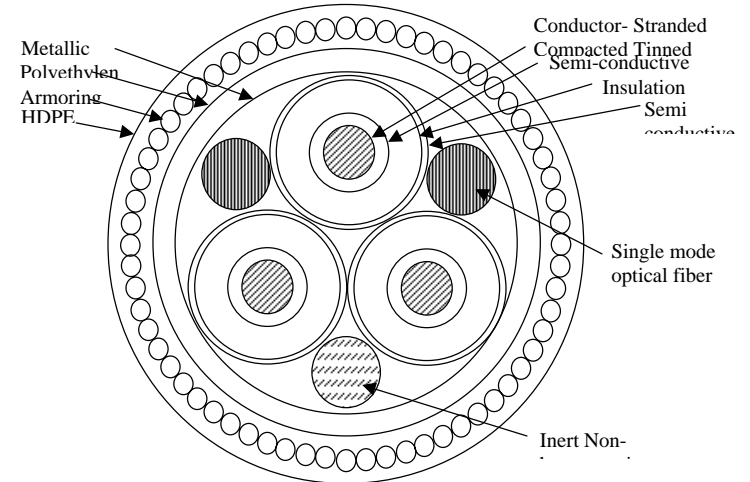

Figure 5-3
Baseline Cable Cross-section

The cable presents several issues that are the subject of discussion later in this report. The electric current through the cable generates an electromagnetic field that may adversely affect sensitive species, either from the electric field or from a magnetic field. The power lost in the cable results in some heating of the cable and nearby water and sediment.

6 WEC TECHNOLOGY ELECTRIC AND MAGNETIC FIELD EFFECTS ON MARINE LIFE

6.1 INTRODUCTION

Animals, including all marine life, are exposed to electric and magnetic fields and influences in their natural environments. This exposure has the potential to affect marine organisms in a variety of ways. This analysis considers only the potential for behavioral effects. Although there may be effects at the cellular and even molecular level, this analysis has found no data on these effects on marine life. Some species have developed sensory receptors than can detect electric or magnetic fields and then use this information for various behaviors. The sensing of electric fields by animals is termed electroreception. The sensing of magnetic fields is magnetoreception.

Power cables generate both electric and magnetic fields. The strength of both types of field depends on the details of the magnitude and type of current flowing through the cable, the construction of the cable and shielding if any, and grounding of the system. In addition, the flow of seawater across the electric field of a power cable generates a weak magnetic field. This analysis assesses whether the electric or magnetic fields created by the WEC system have the potential to adversely impact marine life in the vicinity of the project site.

6.2 WET CABLE MAGNETIC AND ELECTRIC FIELDS

The electric and magnetic fields surrounding the WEC undersea power cable have been calculated for a range of electrical currents through the cable. The fields were calculated using equations developed by AT&T Bell Laboratories for electrical cables on the surface of the seafloor (AT&T 1968; Tucker 2002a). The baseline power cable design was used for these calculations.

Magnetic Field (H). The chart in Figure 6-1 shows the calculated magnetic field strength near a bottom laid power cable. Figure 6-2 shows the calculated field in seawater in units of microTesla (μT).

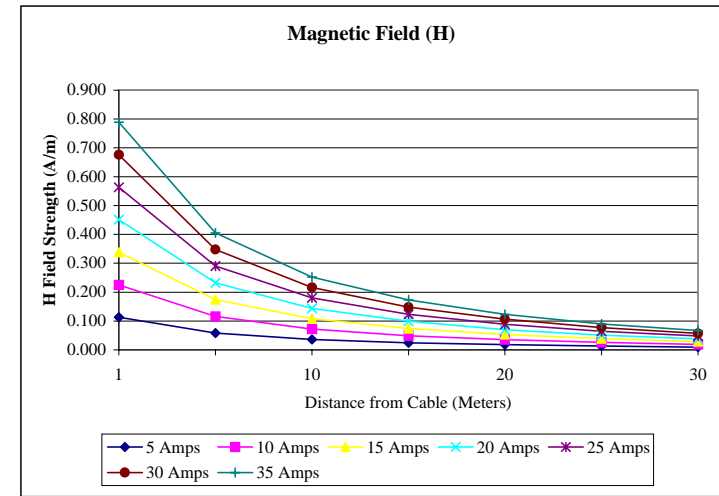

Figure 6-1
Calculated Magnetic Field Near the WEC Undersea Power Cable

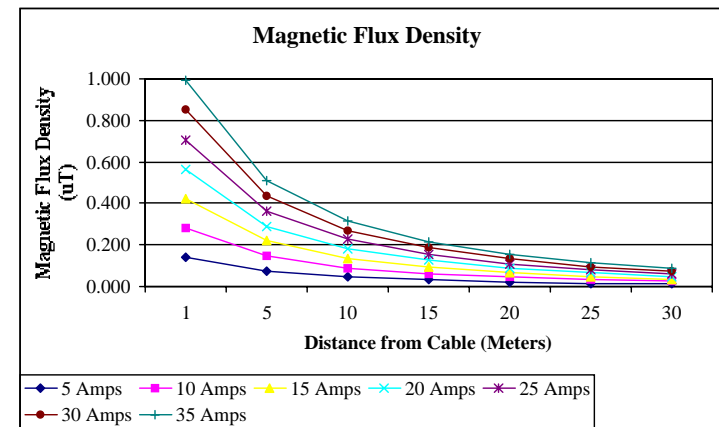

Figure 6-2
Magnetic Field of WEC Undersea Power Cable in Seawater in MicroTesla

Electric Field (E). The chart in Figure 6-3 shows the calculated longitudinal electric field strength near a bottom laid power cable. Figure 6.4 shows the calculated distances from the cable to the 0.5 μV and 5 μV contours.

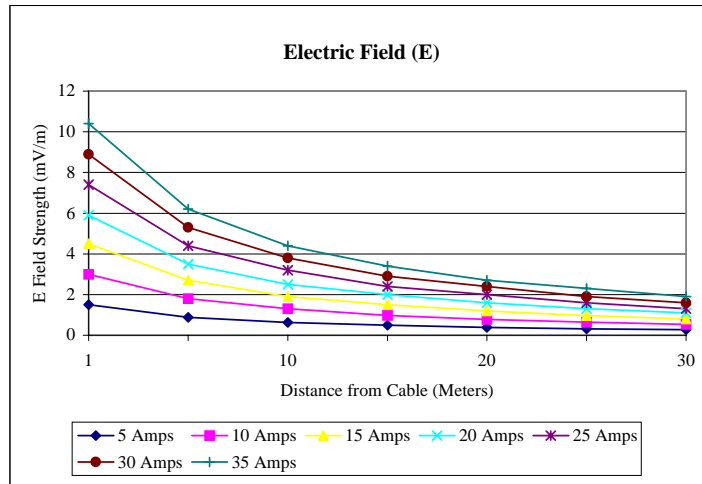

Figure 6-3
Calculated Electric Field Near WEC Power Cable

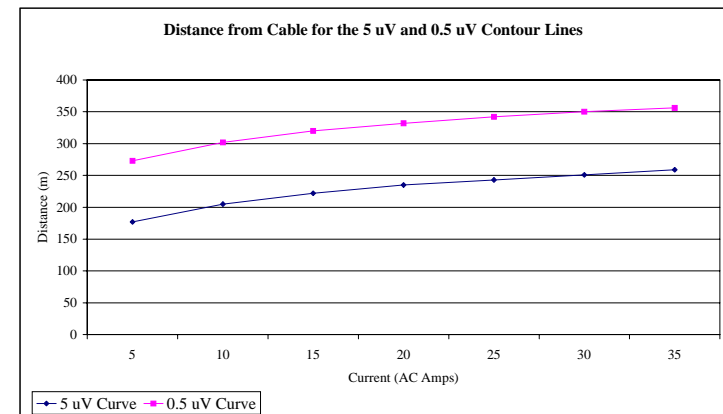

Figure 6-4
Calculated Distances to 0.5 μV and 5 μV

6.3 ELECTRORECEPTION AND MAGNETORECEPTION

Marine organisms live in an environment enveloped by electric and magnetic fields. From earth's geomagnetic field, the natural magnetic background varies from 24 μT (micro Tesla) at the equator to 62 μT at the magnetic poles. Near the equator, the magnetic flux lines are aligned essentially parallel to the earth's surface but approaching the poles, the flux lines dip to perpendicular as they point towards the earth's core. When the ions in sea water flow through this magnetic field, weak electric fields on the order of 5-50 $\mu\text{V/m}$ (Enger 1992) are generated by induction, and nature responds. As suggested by Poleo et al. (2001), if the chemical and physical properties of an environment can be used as sensory cues, some organism(s) will evolve the sensory apparatus to utilize them. In the marine environment, there are multiple examples of species that do possess (or apparently possess based on their behavior) the sensory apparatus to detect electromagnetic fields. But the physiological mechanisms, and in many cases even the sensory apparatus are unknown or poorly understood.

Electroreception is thought to be widespread; however, the physiological mechanism is understood only in a very limited group of marine species, namely, lampreys (*Petromyzontoidei*), elasmobranchs (sharks, rays and skates), and bradyodonts (chimeras or ratfish) (Bullock et al. 1982). There also are a number of electroreceptive (and electro-generating) freshwater fish, amphibians and monotreme animals (e.g., the duck-billed platypus) but they are not pertinent to this analysis. Other animals are claimed to be sensitive to electric and magnetic fields but no mechanism for how they can sense these fields has been described. In contrast, the electrosensitive organs of elasmobranchs and their physiological mechanisms have been studied in great detail (Lorenzini 1678, Murray 1960, Dijkgraaf & Kalmijn 1962, Kalmijn 1971) (see below).

Still sketchy are explanations for magnetoreception. Behavioral studies have demonstrated that several animals can sense the earth's geomagnetic field or a local magnetic field, and use it as an orientation cue while migrating, homing or moving around within their habitat (Wiltshko & Wiltshko 1995). Laboratory studies have not caught up with the behavioral observations, however, and little is known about the physiological mechanism underlying this sensory ability (reviewed by Lohmann & Johnsen 2000).

6.3.1 Electroreception in fish

Depending on the field strength, fish have three levels of response in electric fields (Enger 1992). Initially, they can sense relatively weak, low frequency electric fields down to $0.5 \mu\text{V/m}$ (with frequencies from near direct current [DC] to greater than 15 kilohertz [kHz] which is usually evidenced by a very weak but visible shuddering of the body or the fins (analogous to humans detecting static electricity). Secondly, they have the ability to feel relatively strong electric fields (field strength from 7 mV/m and higher) whereby the fish swims involuntarily in a determined direction within the field (galvanotaxis). At higher electric field strengths, the fish is paralyzed (electronarcosis or galvanonarcosis). In teleosts (common bony fishes), this occurs at 15 V/m and higher (Balayev and Fursa 1980). Comparing the responses of teleosts (without known sensory organs for weak electric fields) with the sensitivity of elasmobranchs, the difference is enormous. Certain elasmobranchs will respond down to $0.5 \mu\text{V/m}$, more than 14,000 times more electrosensitive than the most sensitive bony fish (at 7 mV/m) (Marino & Becker 1977).

In elasmobranchs, the electroreceptive sensory organs, called the ampullary canals, have been extensively studied and are well understood. Each is essentially a small organic voltmeter that begins with a surface pore connected by a long canal filled with a low-resistance, gelatinous liquid that terminates as a small sac lined with neural sensory cells (Murray 1960, 1962, Waltman 1966, Dijkgraaf and Kalmijn 1966). Whereas a voltmeter measures the voltage difference or potential between two points, in this case, the neural measurement is the voltage potential over the ampule's sensory cells, or in other words, the external electric field versus the fish's internal field. These ampullary electroreceptors appear to be present in all elasmobranch species and are particularly numerous on the head of hammerhead sharks (*Sphyrnidae*). The receptors in lampreys and chimeras are slightly different but functionally similar.

Elasmobranchs' ampullae are mostly clustered into groups with the lengths of the canals varying from species to species. Recent studies indicate that the pattern of ampullary sensors around the heads of rays and sharks are arranged specifically for functional advantage in the species' feeding habits (Tricas 2001). An interesting anatomical observation is that the same numbers of nerve fibers are dedicated to electroreceptors as are dedicated to the eye, ear, and the lateral line (Murray, 1974). The number of nerves that innervate a sensory organ often suggests the sensitivity and degree of acuity of that sensory organ, and further implies the relative importance of that sensory organ for an animal. Consequently, the electrosensitive ampullae seem equally important to an elasmobranch as its eyes, ears, and the lateral line (Murray, 1974).

With their acute sensitivity, elasmobranchs are also capable of using their electric sense in orientation. A shark can sense its speed and local orientation within the electric field induced by the movement of seawater in the geomagnetic field ($5\text{-}50\mu\text{V/m}$). A shark can also sense the electric field induced in the fish itself when it moves in the earth's magnetic field. It has been

calculated that an electric field of approximately $40 \mu\text{V/m}$ is generated in a fish that swims at a speed of 1 meter/second (m/s) (Enger 1992). This means that the fish could be aware of its own movements relative to the geomagnetic field (discussed in magnetoreception section below).

Bioelectric fields are produced by both predator and prey species. Even in a resting state, the difference between the internal and external electrochemical environments of animals creates a voltage gradient across the water/skin boundary. This difference in electro-potential produces current loops which then create a bioelectric field in the surrounding waters. An animal's behavior and movement can also produce electric fields. For example, when a fish swims or its heart beats, muscles contract. And with each muscle contraction, the movement of sodium and potassium ions across the membrane produces a minute electric field that propagates into the surrounding water. The number of muscle contractions affects the magnitude of the electric fields; if more muscles contract, the field strength increases. The result is the establishment of a low frequency AC component atop the steady DC bioelectric field. Sharks and rays are acutely sensitive to these AC fields and utilize them in finding prey.

In a classic laboratory study by Kalmijn (1971), dog sharks could sense the bioelectric field of a flounder buried in sand. Later field work confirmed that larger sharks would attack an artificial dipole source as if they were hidden prey (Kalmijn 1978, 1982). Based on observations of the attack path and the strength of the dipole source, Kalmijn suggests that the sharks have a threshold sensitivity around $5\mu\text{V/m}$. Furthermore, the intensity of the electric fields changes in the case of a wounded animal. For example, crustaceans can generate a voltage of 50.0 mV measured 1 mm away from the surface of the animal. The same crustacean, if wounded, generates a much higher voltage of $1,250 \text{ mV}$ (Kalmijn, 1974). Recent work has also found that male round rays use specific electroreceptors and weak electro-generators socially to identify and locate cryptically hidden females (Tricas and New 1998).

Finally, elasmobranchs are repelled by higher voltage electric fields. As reported in the Basslink IIAS (2002), sharks and rays generally move away from the direct path of an approaching storm (Stepanyuk 1988; personal observations). Stepanyuk studied various species of sharks and rays in the presence of strong electrical fields mimicking those fields produced by high winds and turbulence resulting from strong gale-force storms. The results show that sharks and rays are capable of rapid adaptation to the fields and will generally show no change in behavior. The ability to acclimate to higher fields agrees with the findings that sharks can filter background noise and still remain sensitive to slight variations in local fields, like those produced by prey species (Bodznick et al. 1993, Tricas and New 1998).

Does this tolerance for higher background voltage exist near power cable emissions? In the vicinity of the high voltage direct current (HVDC) cables in Cook Inlet Straits, New Zealand, voltages emissions were measured far above elasmobranch detection thresholds, ranging from $73\text{-}97 \mu\text{V/m}$ (Basslink Final IIAS 2002). Underwater surveys showed sharks still swimming directly over the cables and, in some instances, attacking the remote underwater video camera. The attacks may have been in response to low frequency vibrations, visual stimuli or electrical signals the ROV generates underwater. However, the presence of sharks and the location of the attacks, directly over the cables, confirms that electromagnetic frequency (EMF) emissions from the cable does not deter electrosensitive species from using the area.

True shark repellent behavior also has been studied with research focused obviously on prevention of shark attacks. In the early 1990s, South African inventor Norman Starkey demonstrated that a wire loop immersed in a shark tank and energized by a 12-volt direct current (DC), would invariably cause dusky and bull (*Carcharhinus leucas*) Sharks to flinch and dart away, apparently in a highly agitated state. The Natal Shark Board of South Africa once utilized electric beach perimeters that were mostly successful but later replaced with barrier nets. In 1991, they produced the SharkPOD (Protective Ocean Device) to be worn by divers. The unit is powered by a 12 V battery and generates a low voltage pulsating DC field (estimated at a few volts/m - specifications proprietary). When used correctly, the electrical field is not strong enough to cause undue discomfort to humans, and yet the field is greater than the tolerance level of most sharks tested. In field trials, sharks were repelled at distances of 3.3 ft to 23 ft (1m to 7m) although there were some failures when sharks were in a feeding mode. Descriptions of a shark exposed to a repellent shock include body twitching and flickering of the eye's nictitating membrane (normal closes during an attack). In one study, a White Shark reacted by slamming shut its gill slits, strongly depressing its pectoral fins, and accelerating away rapidly.

In the draft IIAS for the Basslink cable project (2002), anecdotal nonauthoritative references were cited suggesting that despite the ultrasensitivity of elasmobranchs, the sensory range of ampullary electroreceptors may be limited to a distance from a few feet to several inches (few meters to 30 cm) (Martin 2000, Bader 1996, Skeleton Reef 2000--web site content, the later two leading to inactive addresses). Further anecdotal evidence from the SharkPOD trials stating that sharks were repelled at distances of 1-7 m is also intriguing. However, these opinions and observations are insubstantial grounds for assessing (or in this case, minimizing) potential environmental impacts and are not accepted in this review.

6.3.2 Electrical Field Impacts

Chondrichthyans (includes elasmobranchs and chimera) are attracted by the weak electric fields generated by the movement of their prey and repelled by strong electric fields. Based on behavioral studies, the induced electric field from the WET cables will be detectable by some chondrichthyan species, but the field is not strong enough to repel them. From the calculated data in Figure 6-4, if the WET undersea cable were to operate at full potential, ~31 amperes, chondrichthyan species sensitive down to $0.5\mu\text{V/m}$ would detect the cable emissions from 350 m (1150 ft) away.

Based on the wide range of detectable emissions, chondrichthyans in the vicinity of the WEC cable and close to the seabed may be confused by their electrosensory information. However, in the event of sensory confusion, the event should be temporary since any animal capable of higher-order behaviors would undoubtedly rely on more than electrosensory information to complete those behaviors, i.e., visual, olfactory, auditory, chemical, and lateral line pressure sensors.

Based on recent studies on existing cables, the Basslink Final IIAS (2002) concludes that "...the operation of high voltage direct current cables [in Cook Strait] does not appear to disrupt the ecology and behaviour of elasmobranchs in the immediate vicinity. This is directly supported by numerous comments and video evidence of sharks directing attacks at Underwater Video Submersibles during annual inspections of the system. This evidence suggests that the sharks are

able to discriminate between the submarine vessels and the underlying HVDC cables, which they are used to inspect." The new data also corroborates that sharks are not avoiding or repelled by the electrical fields from the HVDC cable. Based on this evidence, the WEC undersea cable with lower voltages and emissions than the Cook Strait HVDC cables, also should have minimal or no impact.

Although there is no concern about the WEC undersea cable impacting the marine life, there is uncertainty in how sharks perceive the cable. Sharks are sensitive to the electrical patterns of prey species, i.e., a DC field with tell-tale heartbeat and gill-breathing pattern suggests something edible is hidden in the sand bottom. But there are no data on how discriminating sharks are with their search image. Would the emissions from a three-phase AC source fluctuating in frequency and voltage be close enough to a prey-like signal or intriguing enough for curious shark to take a test bite? The WEC undersea cable is armored and grounded, and there is no evidence that it will be attractive to sharks.

Teleost fishes, lacking electrosensitive receptors, are less sensitive to electric fields than chondrichthyans. These animals are also expected to detect the electric field gradients within 16 ft (5m) from the cable but it is unlikely they will be adversely affected.

6.3.3 Magnetoreception in Fish

Understanding magnetoreception is even more problematic than electroreception. Although widely documented in marine and terrestrial species including invertebrates and bacteria, there are several subtleties, many theories and mostly just behavioral data to distinguish it; no one has conclusively identified the structural or physiological basis for magnetoreception. At a basic level, there are single-celled bacteria, some seen as 2.5 billion year old fossils and others as living species, that contain biogenic particle chains of magnetite (Fe_3O_4), a natural magnet. These bacteria passively align themselves and then actively move "northward seeking" along magnetic flux lines. It is argued that magnetotactic behavior in primitive bacteria gives credibility to the theory of magnetoreception as a basic primary sensory system that remained and evolved in subsequent species (Kirschvink et al. 2001). This conjecture implies magnetoreception would occur much more broadly than currently documented.

Magnetoreception in higher life forms would serve most appropriately as a navigational aid. There are two functional modes for utilizing magnetic information: as a compass or as a map. In a compass mode, an organism would sense basic polarity of the magnetic field, i.e., north or south. This information would be of limited value to long distance migratory species but may be useful on a more limited scale. For example, current work on magnetoreceptive abilities in a marine sea slug, *Tritonia diomedea*, shows that since local organic accumulations correlate with magnetic (iron-rich) sediments, there is an advantage to being able to sense a magnetic source (Willows 1999). Beyond the local scale, a geomagnetic map mode would be an obvious benefit for any migrant or far-ranging species. To date, there is practically no evidence to demonstrate how the map sensing works but theoretically it would involve assessing the geomagnetic field strength (which varies from equator to pole) and the dip angle of the flux lines (moving from parallel to perpendicular at the poles). There are many details to address in making this model practical, such as acquiring learned behavior to accommodate local magnetic anomalies and adjusting for induced magnetism from the animal's own bioelectric field or magnetic storms

from solar flares. Still, sea turtles and migratory birds have sorted out the details and somehow utilize a geomagnetic mapping process in their travels.

Research for the basis of magnetoreception centers on three of several hypotheses (Lohmann and Johnsen 2000). One involves chemical reactions that are modulated by weak magnetic fields (Schulten and Windmuth 1986). One variety of this chemical magnetoreception is thought to be associated with photoreception since changing the wavelength of light changes the organism's magnetosensitivity (Deutschlander et al. 1999). Another plausible hypothesis is based on a physical interaction between the geomagnetic field and biogenic magnetite particles (Kirschvink et al 2001). Magnetite has been detected in a number of animals (including whales, salmon and pigeons) that orient relative to the geomagnetic field but the physiological evidence for a magnetite-based sensory system is still in the early stage of research. The problem is that the magnetite is usually found diffused and nonaligned at the cellular level and not aggregated into a sensory organ. For example, particles of single-domain magnetite occur in the anterior dura mater of the humpback whale but how can forces on these particles be integrated as a sensory input (pers comm., Currie 2002). A third plausible hypothesis for magnetoreception involves electroreception. The electroreceptive organs of elasmobranchs enable these animals to indirectly sense the geomagnetic field. Critics see complications in an individual fish being able to differentiate between its own locally generated bioelectric field, the induced field from swimming and the geomagnetic field but the idea is conceptually possible. In summary, at present, despite the abundance of behavioral observations, nobody has managed to identify or confirm a primary magnetoreceptor (Lohmann and Johnsen 2000).

Still, behavioral observations do provide a strong basis for stating that elasmobranchs and various cetaceans navigate according to the geomagnetic field. Geomagnetic tracking was initially suggested in the classic work of Klinowska (1986) in looking at trends in pilot whale strandings in the UK. "The total magnetic field of the Earth is not uniform. It is distorted by the underlying geology, forming a topography of magnetic 'hills and valleys.' My analysis shows that the animals move along the contours of these magnetic slopes, and that in certain circumstances this can lead them to strand themselves. In the oceans, sea-floor spreading has produced a set of almost parallel [magnetic] hills and valleys. Whales could use these as undersea motorways, but might swim into problems when they came near the shore, because the magnetic contours do not stop at the beach. They continue onto the land, and sometimes so do the whales." However, the theory may not be complete since it requires whales to sense 1 nanoTesla variations in the geomagnetic background (24-60 μ T). Later studies in the US have corroborated her findings but similar studies in New Zealand and Newfoundland did not. Further experiments have shown that turtles, cetaceans, and chondrichthyans are capable of following geomagnetic contours, geomagnetic valleys or geomagnetic ridges. Lohmann and Lohmann (1993) found that leatherback sea turtle hatchlings could orient to the geomagnetic field in complete darkness and detect the dip in magnetic flux lines. Field observations made by Carey and Scharold (1990) on directional consistency of long distance tracks of free-swimming blue sharks, confirm that elasmobranchs can orient themselves relative to the geomagnetic field. Likewise, studies have shown that when hammerhead sharks travel long distances off the coast of California, they follow a specific route that correlates with the pattern of "magnetic anomalies on the ocean floor" (Paulin, 1995). The ability of European eels (*Anguilla anguilla*) to keep a constant heading during their migrations combined with demonstrated sensitivity to both direction and inclination

of experimental weak magnetic fields suggest that they, too, migrate using geomagnetic cues (Westerberg and Begout-Anras 1999).

Throughout the animal kingdom, animal orientation, migration and homing rely on the geomagnetic field but also a multitude of other cues for which there is no fixed hierarchy of importance. These cues can be visual, olfactory and auditory. The relative importance of these cues depends on an animal's species, age, and environmental experience. Young loggerhead turtles in the Atlantic Ocean respond to magnetic features encountered along their migratory path by swimming in directions that may help keep them within the North Atlantic gyre (Lohmann et al 1999). But adults are thought to use other factors such as chemical cues from target areas in reaching their migratory goals.

6.3.4 Magnetic Field Impacts

From the available information, it is impossible to confidently predict the magnetic emissions impact from the WEC undersea cable on the nearshore biota but it is likely that elasmobranchs, sea turtles and cetaceans can sense the cable's magnetic field. There is little information regarding the threshold levels of sensitivity for these species. Based on background geomagnetic levels and the ability of several species to track geomagnetic features, their sensitivity is likely to be significant. Thus, there are four behavioral scenarios of impact assuming magnetic detection of the cables: 1) detection and no effect, 2) detection and confusion, 3) detection and avoidance or 4) attraction.

The no-effect scenario occurs when the local or migratory animals recognize the magnetic field as unnatural or anomalous and ignore its presence--just another anthropogenic disturbance to the Hawaiian coastline. This scenario is highly probable since the cable will carry alternating current (triple phase AC, up to 180 Hz) rather than the polarized direct current. That is, the magnetic field, no matter how strong, will be nothing like a geomagnetic field if the polarity is cycling.

In the second scenario, the individual may disrupt its current behavior while it "reanalyzes" the situation. The expected outcome is for the individual to assess the information from other sensory cues, ignore the anomalous magnetic perception and continue its previous behavior. This scenario is thought to describe the observations of the temporary disruption of migrating European eels that approached a HVDC cable, veered into its field and then (most) readjusted back onto the migratory route (Enger et al 1976). The fact that most but not all eels corrected their course partially confirms a multi-cue assessment process. On approach, magnetic cues were the primary navigation input until after veering, other single (or multiple) cues contradicted the magnetic information. Some individuals caught the error and readjusted their routes, others did not (within the experiment's limits). As discussed in the previous scenario, the AC magnetic field may perplex the focused migrant but is unlikely to be mistaken as valid geomagnetic input.

The avoidance scenario would be the worst case situation because it would mean that the individuals were intimidated or uncomfortable within the cable's field (note that it would be impossible to discriminate between avoidance behavior from electric versus magnetic field avoidance). Again, as with the electric field impacts, bottom-dwelling organisms would be the most likely to show this avoidance behavior—pelagic species could readily swim over the field. Since the cable route does not cross any known critical migratory paths for threatened or

endangered species nor does the cabling create a geographic barrier (e.g. the Basslink project from Australia to Tasmania), any avoidance behavior should have minimal impact on the local marine populations. Based upon the Cook Strait observations (presented in the electroreception impacts section above), avoidance of power cable emissions does not seem to be an issue for elasmobranchs.

The effects of the fourth scenario, attraction, are again impossible to predict. Typically, solitary animals do not aggregate except for migratory schooling, mating or feeding frenzies. Depending on the species attracted, the number attracted, its behavior in the vicinity, reactions of other species in response to an aggregation and numerous other factors, the impact on the local habitat cannot be estimated. However, there is no recorded precedence for this scenario in marine systems.

6.4 ELECTRICAL FAULT IMPACTS OF WET OPERATION

6.4.1 WET Electrical Fault Protection System

It is possible that during operation, the WEC system might experience an electrical fault or short to seawater. The electrical system incorporates a computer-controlled ground fault detection and interruption system that detects an electrical fault in the system and shunts the electrical current to the load resistors (see Section 8.4 below). The actuation time of this system is between approximately 6 milliseconds (ms) and 20 milliseconds. It should be noted that the WEC undersea cable (see Section 5.4) is armored with steel wires and has an external jacket over the wires. It is a very robust construction and highly resistant to damage. There has been no bottom contact fishing reported at the project site. Damage from bottom contact fishing gear is the most common cause of damage to undersea cables (65% [Rapp 2002]). Anchors are the second most common cause of undersea cable failures (25% [Rapp 2002]). The other 10% of faults are due to the failure of components in the deep ocean and do not apply to the shallow water of the WEC installation site. Thus, a fault induced by either fishing or boat anchors is considered highly unlikely. The other WEC components are housed in the equipment canister and are well protected from external forces. A short to seawater fault is likewise considered highly unlikely for these components.

6.4.2 Electrical Fault Significance Criteria

In the event of an electrical fault, there is a short period of time during which the electrical current generated by the WEC system is shorted to seawater. The length of time and the amount of current are determined by the characteristics of the fault interruption system. If the fault persists, an electric field is set up in the vicinity of the fault with a voltage gradient that depends on the fault current and the distance from the fault. No literature has been found that can provide significance criteria for the impact of this type of highly transient field.

6.4.3 Electrical Fault Impacts

A series of U.S. Navy studies of the effects of electrical fields (Tucker 1986, citing Naval Medical Research Institute [NMRI] and other studies) found that fault durations of less than

20ms, and fault currents of less than 5millivolts had only transient effects on marine life or divers. In divers, these were generally observed as a mild transient discomfort. The NMRI experiments found no short or long-term effects from transient fields less than 20ms and 5mV. That is, the only effects observed were transient in nature. Fields of this magnitude and duration were not sufficient to cause effects on the heart function or muscular function of the test subjects. These Navy studies have been incorporated into Navy diving regulations and into the Association of Diving Contractors (ADC) standard procedures for commercial diving operations (ADC 2000). No literature has been found directly describing the effects of this type of highly transient electrical field on marine life. It is likely that sensitive species of marine life would simply detect the field and be diverted away from the vicinity of the fault during the brief period while the ground fault system actuates.

6.4.4 Electrical Fault Mitigation

The best means of mitigating the impacts of an electrical fault are to prevent it from happening. The strength of the WEC undersea power cable and its armored construction provide the first level of mitigation. If there is a fault, the computer-controlled electrical fault detection and circuit interruption system shunts the electrical current to the load resistors in from 6 to 20ms, limiting the duration of the electrical field created by a fault.

7 BIOLOGICAL ASSESSMENT OF NOISE IMPACTS FROM THE WET PROJECT

7.1 INTRODUCTION

Marine vertebrates typically have the ability to sense underwater sound and many also have the ability to make sounds. Marine vertebrates include marine mammals (i.e., cetaceans [whales and porpoises], pinnipeds [seals and sea lions], sea turtles, and fishes. With regard to sound, marine mammals such as the humpback whale are the most highly evolved. Cetaceans, including baleen and toothed whales and porpoises, produce sounds to communicate with and identify each other, visualize and navigate within their surroundings, and locate their prey. Pinnipeds may use sound for many of the same purposes but their capabilities are not as well understood as the capabilities of cetaceans. It is clear, however, that pinnipeds do not have near the sound production versatility of cetaceans. The auditory and hearing capabilities of sea turtles are not well known but they appear quite primitive. Finally, most fishes are sensitive to noise but only a few have sound production capabilities (e.g., croakers).

For those animals that produce sound, the ability to detect and discriminate between complex frequency spectra is critical to the success of the behaviors for which sound production evolved and to their survival. Consequently, projects introducing artificial sound sources into the marine environment have the potential to affect the communications, navigation, and foraging success of marine vertebrates. Moreover, anthropogenic sounds can potentially injure or kill marine vertebrates if they are sufficiently intense.

7.2 WET GENERATOR SYSTEM DESIGN

Three elements of the design of the WET generator system (generators and mooring arrays) important to the analysis of noise effects on the marine animals are the geographic location of the arrays, the conceptual arrangement of the arrays and the sounds they will produce, and the nature of the generators themselves, especially regarding the sounds they will produce. As many as six arrays will be installed in the proposed deployment area at water depths ranging between 90 and 110 feet. The footprint for the installation is approximately 150 X 250 m. The installation area is located approximately 1,000 m NE of Marine Corps Base Hawaii (MCBH Kaneohe) on Mokapu Peninsula in Kaneohe, Oahu. An important consideration is that MCBH Kaneohe, which includes the Marine Corps Air Station Kaneohe, supports helicopter and jet fighter flight operations. The installation area is directly in the flight path for a major runway at MCAS Kaneohe.

Currently, no information has been provided on the conceptual arrangement of the arrays, the nature of the generators, or the sounds either of these devices will generate.

7.3 ACOUSTIC TERMINOLOGY AND RELEVANT CONCEPTS

Terminology used in acoustical discussions is complex. Definitions of several acoustical variables or properties relevant in the discussion of the sounds produced by this project are provided below. These are based on definitions provided by Richardson et al. (1995).

- Frequency – Rate of oscillation or vibrations as measured in hertz (Hz = cycles per second).
- Tone – The sound produced by a single specific frequency.
- Frequency Spectrum – The combined frequencies representing the sounds produced by a particular phenomenon or audible to an organism. The frequency spectrum of bottlenose porpoise vocalizations ranges from ~300 to 24,000 Hz. The frequency spectrum audible to humans is approximately 20 to 20,000 Hz.
- Ultrasonic and infrasonic frequencies – Sounds that are either too high or too low, respectively, to be heard by humans.
- Propagation – Passage of sound on paths away from the source.
- Transmission – Propagation of sound from a source through a medium (e.g., air, water, or sediment) to a receiver. Sound production by a source can be transient or continuous. Sounds from the drilling will be transient whereas ambient noise and sounds from the wave energy generators will be continuous. Sound changes during transmission from the source to the receiver.
- Propagation (= transmission) Loss – Loss of sound power as distance from the source increases.
- Sound Pressure – The pressure associated with a sound wave.
- Pascal (Pa) – Unit of pressure equal to 1 newton per sq. meter, 10 dynes/cm², or 10 μbars.
- Decibel – A logarithmic measure of sound strength, calculated as $20 \log_{10} (P/P_{ref})$, where P is sound pressure and P_{ref} is a reference pressure (e.g., 1 μPa).

- Sound Pressure Level – Sound pressure measured in decibels.
- Source Level – Acoustic pressure measured at a standard reference distance from a point source of sound (usually 1 m away). Usually measured in dB re 1 μPa at 1 m (=dB re 1 μPa-m). Source levels for different frequencies comprising a specific sound may vary.
- Sound Intensity – A general term representing several related ways of describing the distribution of sound pressure versus frequency. Sound pressure density spectrum measures continuous distribution of energy in a specific frequency range in pressure squared per unit frequency (μPa²/Hz). This applies to the noised emanating from the wave energy generators. Sound pressure density spectrum level (=SPDSL or spectrum level) measured in decibels (dB). Sound pressure spectrum level (SPSL) measured in decibels (usually dB re 1 μPa).

The concept of spherical spreading is important to these discussions. Sound generally spreads in spherical waves. In deep water, the received level of sound diminishes by 6 dB with a doubling in range or by 20 dB with a 10-fold increase. Thus, sound levels typically decrease by 10 dB at a range of 10 m and 40 dB at 100 m. Consequently, a sound measured at 160 dB re 1 μPa at a distance of 1 m from the source will measure 150 dB at a range of 10 m and 120 dB re 1 μPa 100 m away from the source. However, these relationships differ in shallow water and at low frequencies.

7.4 AMBIENT NOISE

Typically the three primary sources of ambient noise in the ocean are: 1) distant shipping, industrial, or seismic-survey noise; 2) wind and wave noise; and 3) biological noise. Wille and Geyer (1984) reported that ambient noise levels in shallow waters are related directly to wind speed but only indirectly to sea state. However, because of this site's proximity to the shore, wave noise will be a strong contributor to ambient noise, especially when large swells emanating from winter storms in the Gulf of Alaska impinge on the north-facing beaches of the Mokapu Peninsula.

Wenz (1962) compiled information on ambient noise contributions from various sources into a depiction of generalized ambient noise spectra (Figure 7-1). He indicated that the frequency spectrum for ambient noise ranged from infrasonic to ultrasonic levels. In terms of sound intensity, he reported Sound Pressure Density Spectrum Level (SPDSL) ranging from about 20 to 140 dB re 1 μPa²/Hz. Highest intensity occurs in the infrasonic range and sound intensity declines increasingly as frequency increases.

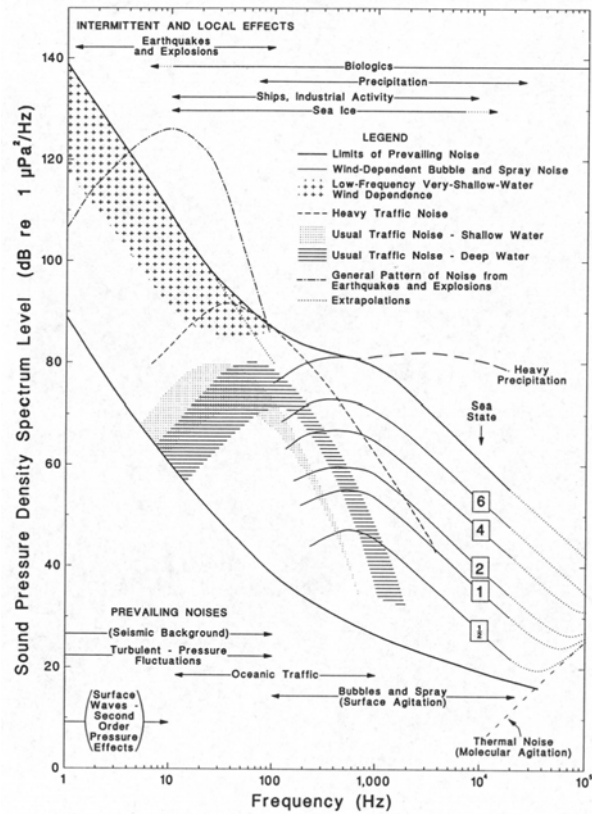

Figure 7-1
Generalized oceanic ambient noise spectra attributable to numerous natural and anthropogenic sound sources. Based on Wenz (1962); extracted from Richardson et al. (1995).

Within the human auditory range, SPDSLs range from about 50 to 100 dB re $1 \mu\text{Pa}^2/\text{Hz}$ at the lower end of the frequency spectrum to about 20 to 58 dB re $1 \mu\text{Pa}^2/\text{Hz}$ at the upper end of the audible spectrum. This analysis shows the effect of sea state, shipping heavy precipitation, and nearshore wave action. Considering that a typical sea state in this area is probably 3 to 4, one can

project that baseline levels for ambient noise range from about 60-65 dB re $1 \mu\text{Pa}^2/\text{Hz}$ at 100 Hz to about 40 dB re $1 \mu\text{Pa}^2/\text{Hz}$ at 10,000 Hz.

As a result of noise from surf and surface wave noise, the quality and quantity of ambient noise differ substantially between nearshore areas (1-300 feet deep and within 1-3 miles of shore) and deep water. Noise levels in shallow water are typically somewhat higher for low frequencies (0-1kHz) and much higher at frequencies above 1 kHz. Heavy precipitation can cause elevated SPDSL at frequencies between 1,000 and 10,000 Hz.

It is likely that the three primary sources for ambient noise at this location include aircraft noise from operations at MCBH Kaneohe. Comparison of acoustic characteristics of helicopters and jet fighters (Figure 6.4, Richardson et al. 1995) indicate that overflight by an F-4C jet fighter with its after-burner produces sound levels (1/3- octave bands) above 130 dB re $1 \mu\text{Pa}$ at 300 m in the 100 Hz frequency range and this only declines to about 120 dB re $1 \mu\text{Pa}$ at 300 m at 10,000 Hz. Helicopters, peaking at about 100 dB at about 20 Hz and dropping below 90 dB at about 300 Hz, have very different acoustic characteristics. Most of their sound energy is below 500 Hz. Helicopters are noisier than similar-sized fixed wing aircraft. All aircraft tend to be noisier on takeoff than while cruising (Richardson et al. 1995). Airborne noise couples well into the water.

Thus, because MCBH Kaneohe supports both helicopter and fighter jet squadrons, aircraft operations undoubtedly contribute substantially to ambient noise. It is further likely that the waters in the vicinity of the proposed project installation site will be especially noisy because it located off the end of a runway where fighter jets are activating their after-burners while taking off.

At present, no data on ambient noise are available for this site. However, based on measurements taken recently in Kauai at a deepwater site, ambient noise at this site may be greater than projected above. At a deep-water site north of Kauai with water depths ranging from 2,800 to 4,400 m, average ambient noise levels between 96 and 105 dB re $1 \mu\text{Pa}$ were observed. In view of the facts that the project site is near a beach and is in the flight path of MCAS Kaneohe which services both helicopters and fighter jets, it is likely that the level of ambient noise is greater than was observed at Kauai.

The aggregate of the various ambient noises strongly affects the distance to which mammal calls, specific man-made noises, and other sound signals can be detected. Therefore, measurements of ambient noise from the project area would be helpful in evaluating the potential impacts of sounds that will be produced by the wave energy generation system.

7.5 WET PROJECT NOISE GENERATION

Noise will be produced by two different activities in the project area. First, installation of the moorings for the WEC systems will produce transient noises. The hydraulic drills used to drill holes in the rocks for the anchors will produce these noises. The installation operations will occur only for a limited period and the drilling sounds probably will be intermittent during that period.

Second, operation of the wave energy generator systems will produce continuous sounds during the operation of the system. The intensity and dominant frequencies of the sound may vary with the intensity of the swells but that is unclear at this time. The acoustic characteristics of these two types of noise are discussed below.

7.5.1 During Construction of WEC Arrays

An element of the Wave Energy system includes a secondary anchor system comprising rock bolts that are drilled and grouted into the bottom. Concern has been expressed about the noise generated by rock drills that are proposed for drilling these holes. Data on the noise generated by the drills were extracted from a report on the performance of rock drills (John J. McMullen Assoc. 1984). Relevant parts of these data are summarized in Figure 7-2.

These data indicate that the sounds produced by all three drills are all reasonably similar in terms of the frequency range and the sound pressure levels (Figure 7-2). Frequencies ranged from about 15 Hz to over 39,000 Hz. Sound pressure levels, ranging from about 120 dB Ref 1 μ Pa to nearly 170 dB Ref 1 μ Pa, were relatively consistent across the frequency spectrum. To a small degree, mid-range frequencies had higher intensity than either low-range or high-range frequencies but intensities were remarkably consistent. The broadband sounds of the drills have a relatively uniform intensity across the frequency spectrum.

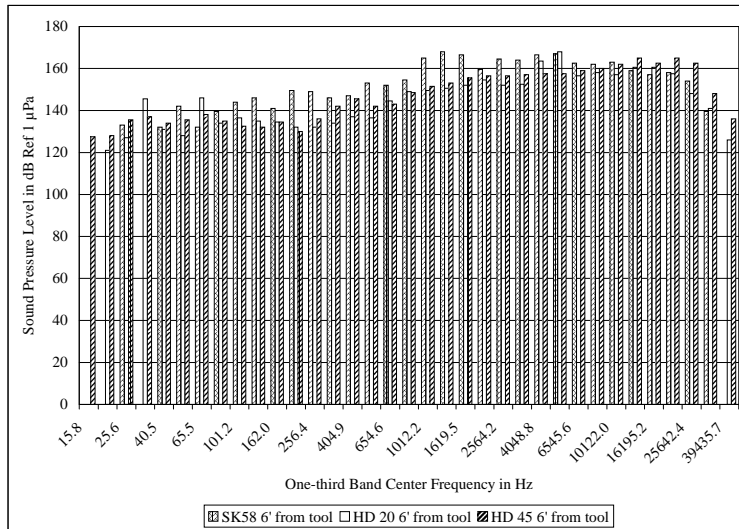

Figure 7-2
Sound Pressure Levels At A Range Of Frequencies For Three Hydraulic Drills Tested Underwater As Measured By Hydrophones 6 Feet From The Operating Drill

7.5.2 During WET System Operation

Data on the spectrum and amplitude of noise produced by the WET system during operation are not available. A search has been made for acoustic data on in-water systems that might be considered comparable to the WET hardware. There are, of course, a number of underwater operations that produce significant acoustic energy from mechanical operations, as opposed to, for example, sonars, seismic exploration and other such activities. There is a considerable amount of data available on the noise produced by offshore drilling and other resource recovery activities, and by ships of different classes and sizes. These data indicate that the acoustic energy produced by these sources is broadband with frequency lines that correspond to specific pieces of machinery. The amplitude of the noise is ranges from about 70dB to about 170dB re: 1 μ Pa (Stocker, 2002). The amplitude of acoustic energy produced by the WET system in operation is expected to be at the lower end of this range, based on the mechanical components that are in the system and the methods used to mount them to the structure. Generally, the WEC equipment is contained (e.g., in the equipment canister) or mounted to the structure through mounting pads. In both cases, the acoustic energy produced by the equipment is not well coupled to the seawater, reducing the radiated noise significantly. Although this cannot be quantified without field measurements, experience with mounting of shipboard equipment has shown that even small sound isolation measures reduce the radiated noise substantially. Although the mounting and enclosure of the WET system equipment is not designed specifically for noise reduction, it has the same practical effect. These considerations suggest that the amplitude of the acoustic output from the WET system in operation is probably in the range of 75 to 80 dB, with a generally broadband spectrum with lines that correspond to specific items of equipment. This is equivalent to "light" to "normal" density shipping noise (Stocker, 2002). The fundamental frequency of the WET system will be the same as the wave frequency due to the motion of the buoy. The spectrum of the acoustic output from the WET system is likely to be shifted to somewhat higher frequencies than typical shipping noise. The lines in the spectrum are expected to be due to the generator, hydraulic system and motion of the buoy itself.

7.6 MARINE VERTEBRATES COMMONLY OCCURRING IN PROJECT AREA

The principal focus of concern for projects creating disturbance and contributing noise in nearshore waters is potential impacts caused by noises to cetaceans, pinnipeds, and sea turtles. While fish also respond to noise, the concerns are considerably less because few fish have the conservation status that many cetaceans, the only local pinniped, and all sea turtles do. A list of the marine mammals (whales, porpoises, and pinnipeds) and sea turtles that are likely to traverse through or feed in this area is presented in Table 7-1. Fish are not considered at this time

7.6.1 Ceteceans

Twenty-three species of marine mammal are recorded from the Hawaiian and Leeward Islands (Richardson et al. 1995). This number includes five baleen whales, six large toothed whales, 12 porpoises, and one pinniped. The pinniped (Hawaiian monk seal) routinely hauls out on isolated beaches to rest. The majority of the whales and porpoises live in deep water and seldom venture within sight of land. Of the remaining species (one baleen whale, two large toothed whales, and seven porpoises; Table 7-1), several are uncommon near shore or in shallow water but are

observed occasionally. Nevertheless, they have been included in this discussion because of the small chance that they might pass through the project area.

7.6.1.1 BALEEN WHALES

Humpback Whale (*Megaptera novaeanglia*): The only baleen whale that occurs in the passages or channels among the island and that might therefore occur in the vicinity of the project area is the humpback whale. Humpback whales occur in Hawaiian waters from November through April. They overwinter here after migrating from coastal areas of the North Pacific (e.g., Alaska). During their sojourn, they breed and give birth to calves. Although they are often seen in nearshore waters, they apparently are more common in deeper water and around offshore banks.

According to an observer at MCBH, “During the season, humpback whales have been observed within our 500-yard security buffer in large numbers weekly, as many as 15 observed at one time. They have also been observed on occasion in less than 15 feet of water along the sandy coastal areas of MCBH. Three seasons ago, a cow gave birth off North Beach. She has since returned each year with her calf. The proposed site for the WEC is within an area where humpbacks do frequent. Tail slapping, breaching, and pods are routinely observed off MCBH shores. A dead adult humpback was observed a few hundred meters off Pyramid Rock this past season.” (G. K. Olayfar, MCBH, pers. comm.)

7.6.1.2 LARGE TOOTHED WHALES

Sperm Whale (*Physeter macrocephalus*): These large whales occur mainly in the channels and passages when in Hawaiian waters, where they are found primarily in the summer. Mainly females and calves are observed and they are uncommon. It is unlikely that sperm whales would ever travel near the project area.

Cuvier’s Beaked Whale (*Ziphius cavirostris*): These moderate-sized whales (up to 23 feet in length) occur year-round mainly in deep waters in Hawaiian waters. While they remain all year, they are uncommon. It is unlikely that Cuvier’s beaked whale would ever travel near the project area.

7.6.1.3 PORPOISES AND DOLPHINS

Bottlenose Dolphin (*Tursiops truncatus*): This moderate-sized dolphin (8-11 feet long) is the most common of the porpoises in Hawaiian waters. They occur in groups of 2 to 15 year-round in shallow and deep water. It is likely that bottlenose dolphin pods commonly travel through the project area.

Pantropical Spotted Dolphin (*Stenella attenuata*): Spotted dolphins are somewhat common. This small dolphin (up to 7 feet long) occurs year-round in Hawaiian waters in moderate to large (>100 individuals) pods with largest pods observed in spring and summer. It is likely that spotted dolphin pods pass occasionally through the project area.

Hawaiian Spinner Dolphin (*Stenella longirostris*): Spinner dolphins are common but observed only about half as frequently as bottlenose dolphin. However, this small dolphin (5.5 to 6.5 feet long) generally occurs in pods larger than 50 individuals and pod size often exceeds 150 animals. They live year-round in Hawaiian waters. It is likely that spinner dolphins commonly transit through the project area on their trips between Kaneohe Bay and deep water.

False Killer Whale (*Pseudorca crassidens*): These moderately large porpoises (up to 19 feet in length) are not commonly observed in Hawaiian waters even though they travel in pods of several hundred and are present year-round. It is likely that false killer whales could travel near the project area.

Pygmy Sperm Whale (*Feresa attenuata*): This uncommon porpoise is usually observed only in deep water. A year-round resident, they occur in moderate-sized pods (<10 to >40). It is unlikely to ever travel near the project area.

Short-finned Pilot Whale (*Globicephala macrorhynchus*): The pilot whale is commonly observed in inter-island channels in pods of 20 to 40. This large porpoise occurs year-round but apparently does not venture into shallow water very often. It is possible that it could travel near the project area.

Melon-headed Whale (*Peponocephala electra*): This small porpoise occurs in Hawaiian waters year-round. Although it occurs in pods of more than 1,000 animals, it lives primarily in deep water and is wary of vessels; consequently, it is not commonly observed and is unlikely to ever travel near the project area.

Table 7-1
General Distribution And Abundance Patterns For Marine Mammals In Hawai'i.

Cetaceans	Most Likely Season	General Abundance	Principal Activities	Likely Water Depth	Likely to Occur Commonly in Project Area	Types of Sounds Produced	Dominant Range of Sound Production (Hz)
Baleen Whales - Mysticetes							
Humpback Whale <i>Megaptera novaeangliae</i>	November through April for breeding	Common; generally around offshore banks	Calving and breeding	Nearshore & near-island areas	Yes; Observed commonly in large numbers in 500 m buffer	Songs Shrieks Horn blasts Moans Grunts Pulse trains Clicks	120-4000 750-1800 410-420 35-360 - 25-80 2000-8200
Toothed Whales - Odontocetes							
Sperm Whale <i>Physeter macrocephalus</i>	Late spring through fall	Uncommon; mainly females & calves	Nursery and harem herds	1000 fathoms or more	No	Clicks 100-30,000	2,000-4,000, 10,000-16,000
Cuvier's Beaked Whale <i>Ziphius cavirostris</i>	Year-round	Uncommon	All types	Deep water	No	-	-
Dolphins							
Short-finned Pilot Whale <i>Globicephala macrorhynchus</i>	Year-round	Common, mainly in inter-island passages	All types	Usually in deep water	No	Whistles 500-30,000+	2,000-14,000
False Killer Whale <i>Pseudorca crassidens</i>	Year-round	Infrequent	All types	Usually in deep water	No	Whistles	4,000-9,500
Melon-headed Whale <i>Peponocephala electra</i>	Year-round	Uncommon; herds >100	All types	Usually in deep water	No	-	-
Pygmy Killer Whale <i>Feresa attenuata</i>	Year-round	Uncommon	All types	Usually in deep water	No	Growls Blats	-

Table 7-1
General Distribution And Abundance Patterns For Marine Mammals In Hawai'i.

Cetaceans	Most Likely Season	General Abundance	Principal Activities	Likely Water Depth	Likely to Occur Commonly in Project Area	Types of Sounds Produced	Dominant Range of Sound Production (Hz)
Dolphins (continued)							
Bottlenose Dolphin <i>Tursiops truncatus</i>	Year-round	Common in groups of 2 to 15; most common in spring	All types	Shallow & deep water	Yes	Whistles Low-freq Narrowband Rasp, Grate Mew, Bark, Yelp	800-24,000 300-900 - - - -
Hawaiian Spinner Dolphin <i>Stenella longirostris</i>	Year-round	Common inshore during day; most common in spring	All types; Feed at night; rest during day	Deep water at night; nearshore and in bays during day	Yes	Whistles (=squeals?) Pulse Bursts Screams	6,800-16,900 5,000-60,000 -
Pantropical Spotted Dolphin <i>Stenella attenuata</i>	Year-round	Common, mainly in inter-island passages & offshore	All types	Usually in deep water	No	Whistles	6,700-17,800
Pinnipeds							
Hawaiian Monk Seal <i>Monachus schauinslandi</i>	Year-round	Rare; endangered species	Foraging	Nearshore waters	No	None observed	-

7.6.2 Pinnipeds

Hawaiian Monk Seal : This unique seal in Hawaiian waters lives year-round in Hawaiian waters. Its population range extends the length of the Leeward Islands and is concentrated on French Frigate Shoals. Nevertheless, it is rare in all areas. According to an observer on MCBH, it is “rarely observed within the MCBH Kaneohe Bay 500-yard security buffer. We average maybe three sightings on our shoreline a year and the same for the nearshore waters. A female successfully gave birth near the Pyramid Rock beach cottages in 1997. When they do haul out, they are primarily seeking a resting site” (G. K. Olayfar, pers. comm.; 30 May 2002)

7.6.3 Sea Turtles

Five species of sea turtle occur in Hawaiian waters but probably only four have a likelihood of being encountered in the vicinity of the project area. These include the green turtle, the hawksbill, the olive ridley turtle, and the loggerhead turtle. The leatherback turtle, the largest of the sea turtles with a length of 1.5 m and weights up to 590 kg, is seen occasionally in Hawaii but occurs only in very deep water. All sea turtles are considered endangered. Table 7-2 presents a summary of general distribution and abundance patterns for sea turtles in Hawai‘i.

Green Turtle (*Chelonia mydas*)

This large sea turtle is by far the most common of the turtles occurring in Hawaiian waters. Maximum carapace length is about 120 cm and weights up to 250 kg have been observed. Its diet comprises mainly marine plants so it spends most of its time grazing in relatively shallow nearshore habitats. Because it is common and feeds in nearshore habitats, the likelihood is high that it will be a common visitor to the project site.

According to an observer at MCBH, “Green sea turtles are prevalent within MCBH coastal waters near and offshore. They have been observed within a few feet of the shorebreak feeding on limu or transiting from one area to another. I have observed green sea turtles as far off MCBH coastal areas (seaward) as three or more miles. Injured, sick, or dead green sea turtles are recovered from MCBH coastal waters often and turned over to NMFS, three this past month” (G. K. Olayfar, pers. comm.; 30 May 2002).

Hawksbill Turtle (*Eretmochelys imbricata*)

This moderate-sized sea turtle is uncommon or rare despite its habitat preference for coral reefs and rocky coasts where it feeds on shellfish living within the crevices of the reefs or rocks. It is rare throughout its range. Maximum carapace length for this turtle is about 90 cm and weights up to 90 kg.

According to an observer at MCBH, a hawksbill turtle was recovered dead last week” so they definitely occur in the area (G. K. Olayfar, pers. comm.; 30 May 2002). Nevertheless, although it prefers nearshore habitats, it is unlikely that the hawksbill will be a frequent visitor to the project area because of its rarity.

Olive Ridley Turtle (*Lepidochelys olivacea*)

The ridley is the smallest sea turtle occurring in Hawaiian waters. Like all except the green turtle, it is uncommon. This turtle migrates thousands of miles between feeding and nesting areas. Like the green and hawksbill turtles, it prefers shallow water where it feeds largely on crustaceans. Maximum carapace length is about 75 cm and weight attains up to 45 kg (nesting females).

Loggerhead Turtle (*Caretta caretta*)

This moderately large sea turtle is uncommon in Hawaiian waters. It appears to prefer coastal bays but is probably mainly a resident of the open seas. Loggerheads migrate across the Pacific Ocean. Maximum length of the carapace is about 102 cm and weights attain up to 115 kg. They feed largely on crustaceans, mollusks, sponges, and algae when in coastal areas. Because of its rarity, it is highly unlikely that this sea turtle would be a frequent visitor to the project site.

**Table 7-2
General distribution and Abundance Patterns for Sea Turtles in Hawai‘i**

Sea Turtles	Most Likely Season	General Abundance	Principal Activities	Likely Water Depth	Likely to Occur Commonly in Project Area
Green sea turtle <i>Chelonia mydas</i>	Year-round	Relatively common; endangered	Feeding on seagrasses and algae	Shallow nearshore habitats	Yes
Hawksbill sea turtle <i>Eretmochelys imbricata</i>	Year-round	Very rare; endangered	Feeding on shellfish; nesting	Coral reefs & rocky coasts	No
Olive ridley turtle - <i>Lepidochelys olivacea</i>	Year-round	Rare; endangered	Feeding on crustaceans, tunicates & salps	Shallow water	No
Loggerhead turtle <i>Caretta caretta</i>	Year-round	Rare; vulnerable	Feeding on crustaceans, mollusks, algae, etc.	Prefers coastal bays but also open seas	No
Leatherback turtle <i>Dermochelys coriacea</i>	Year-round	Very rare; endangered	Feeding on jellyfish	Very oceanic; deep water	No

7.7 SOUND PRODUCTION AND AUDITORY SENSITIVITY IN MARINE ANIMALS

7.7.1 Ceteceans

Richardson et al. (1995) provide considerable information on sound production by cetaceans and pinnipeds. Of the species of concern in this analysis, they provided data for humpback whales, sperm whales, Cuvier’s beaked whale, bottlenose, spinner, and spotted dolphins, and short-finned pilot, false killer, and pygmy killer whales (Table 1). They also provided limited information on the acoustical thresholds of marine mammals and, for comparison, humans in water (Figure 3).

Marine mammals exhibit considerable variation in the frequency spectra used during vocalization. The frequency spectra produced by some species appear to be somewhat restricted whereas other species are capable of producing a wide range of frequencies. The humpback produces a wide range of sounds but these sounds encompass only a moderate range of frequencies (Table 1). The dominant frequency spectra have been reported for most of these sounds. This range seems to extend from ultrasonic (25 Hz) to moderate frequencies in the audible range (8,200 Hz). Source levels of 144 to 192 db re 1 μ Pa at 1 m have been reported for its many sounds (Richardson et al. 1995). No data are available on its acoustic thresholds but we assume they must at least cover its range of sound production.

Bottlenose dolphins also produce a wide range of sound (Table 7-1) but dominant frequency spectra have been reported only for a few of the sounds. The frequencies appear to extend from the audible range (300 Hz) into the ultrasonic range (24,000 Hz). The acoustic thresholds for the bottlenose dolphin range from 100 Hz to over 100,000 Hz (Figure 3), far exceeding the known range of sound production for the species. Sensitivity at 100 Hz is low (~130 db re 1 μ Pa) but hearing abilities become increasingly sensitive into the upper end of audible sound (~45 db re 1 μ Pa) and continuing at that level in the ultrasonic range to about 100 kHz. Between 100 and 120 kHz, sensitivity declines rapidly to about 100 db re 1 μ Pa. Source levels of 125 to 173 db re 1 μ Pa at 1 m have been reported for its whistles (Richardson et al. 1995).

The known sound production range of the Hawaiian spinner dolphin extends from 5,000 to 60,000 Hz (Table 1). Only three types of vocalizations have been reported. Source levels of 108 to 125 db re 1 μ Pa at 1 m have been reported for its whistles and pulse bursts (Richardson et al. 1995). No data are available on its acoustic thresholds but we assume they must at least cover its range of sound production.

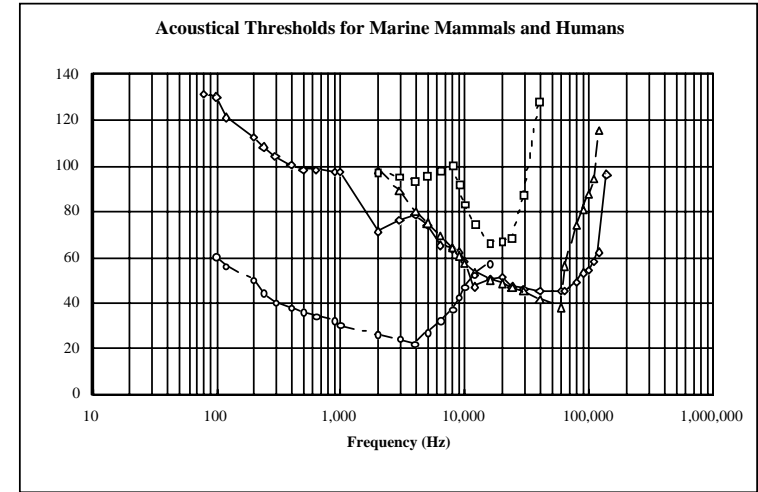

Figure 7-3
Acoustic Thresholds of Two Porpoises and the Hawaiian Monk Seal in Water, and Humans in Air

For the false killer whale, the only type of sound described so far is a whistle. The frequency spectrum for that signal ranges from 4,000 to 9,500 Hz (Table 1). Source levels have not been reported. Acoustics thresholds extend far beyond the known range of vocalization. At the lower end of the spectrum, this porpoise detected a frequency of 2000 Hz at about 100 db re 1 μ Pa. Sensitivity increased uniformly through the audible range and into the ultrasonic range. It was most sensitive at about 60,000 Hz (<40 db re 1 μ Pa) and then sensitivity declined sharply to about 115 db re 1 μ Pa at a frequency of 120 kHz.

Only one or two sounds are reported for the remaining whales and porpoises (Table 1). These include clicks (sperm whales), whistles (pilot whales and spotted dolphin), and growls and blats (pygmy killer whales). The sperm whale and the pilot whale appear to have the greatest range of frequencies (100-500 to 30,000 Hz). The reported frequency range of spotted dolphin vocalizations is from 6,700 to 17,800 Hz.

7.7.2 Pinnipeds – Hawaiian Monk Seal

Only one species of pinnipeds is known to inhabit the Hawaiian Islands and Midway Atoll, the Hawaiian monk seal (*Monachus schauinslandi*). No underwater vocalizations have been measured (or observed?) for the Hawaiian monk seal. While some hair seals can detect sound up to 180 kHz, the monk seal appears far more limited in its acoustical thresholds (Figure 3). Sensitivity is relatively high between 2,000 and 10,000 Hz (~100 dB re 1 μ Pa) and then increases

sharply to about 65 dB re 1 μ Pa at 20,000 Hz. Sensitivity then declines rapidly to about 130 dB re 1 μ Pa at 40,000 Hz.

Other phocid species (harbor seal and northern elephant seal) show a generally increasing sensitivity from lower to higher frequencies, with underwater sound detection thresholds of 101.9 dB and 98.3 dB re 1 μ Pa, respectively (Kastak and Schusterman, 1998).

7.7.3 sea turtles

The sea turtle ear has a single bone in the middle ear that conducts vibrations to the inner ear. Researchers have found that sea turtles respond to low frequency sounds and vibrations. It is likely that all species hear low-frequency sound as adults (Ridgway et al., 1969; O'Hara and Wilcox, 1990). However, little research has been conducted into hearing of sea turtles and their ability to detect sounds in mid - or high-frequency ranges.

A team from the New England Aquarium and the University of Maryland has started audiometric research with a 60-year old captive green sea turtle. The hearing capabilities of this turtle are being investigated using psychophysical methods, standard operant conditioning techniques, and positive reinforcement schedules commonly used with marine mammals. Preliminary data indicate that the turtle hears tones ranging from 100 Hz to 500 Hz. Studies indicate that at 200 Hz, her threshold is between 107 dB and 119 dB, and at 400 Hz, the threshold is between 121 dB and 131 dB. These results represent the only behavioral data available on the range of sea turtle hearing. However the data should be interpreted cautiously because of the turtle's age. It is reasonable to predict that younger turtles might have a slightly wider bandwidth and are able to hear lower intensity sounds than this older turtle.

Sea turtles do not appear to have the ability to vocalize other than the sounds of exhalation while breathing at the surface of the water.

7.7.4 Fish

In general, fishes perceive sound in the 50-2000 Hz band, and peak sensitivity lies below 800 Hz. Of the estimated 27,000 fish species, only a small percentage has been studied in terms of audition or sound production. No fish species are known to be deaf. Of those studied, many fishes produce vocalizations in the low frequency band. Hearing or sound production is documented in 247 species comprising 58 families and 19 orders. Although diverse morphological and physiological mechanisms of hearing have evolved in fishes, hearing capabilities seem relatively homogenous within orders (Popper and Fay, 1993).

7.8 AUDITORY MASKING

The term auditory masking is used to describe the degree to which background noise interferes with hearing thresholds. Hearing thresholds are measured in a quiet environment to determine the lowest levels of sound detectable. Normal conditions in the sea are far from quiet, even in the absence of anthropomorphic noises (see Figure 7-1). This background noise can mask sounds produced by marine animals and sounds that are generated by other means (e.g., anthropogenic

sounds). Such auditory masking is quantified by determining the amount by which a pure tone must exceed normal background noise in order to be detected. This amount, termed Critical Ratio (CR), is measured in decibels.

For the animals that could be found near the project area, Critical Ratio has been measured only for bottlenose dolphins and false killer whales (Richardson et al. 1995). These two animals have somewhat similar CR profiles. In the case of the bottlenose dolphin, CR values increase from about 25 dB at a frequency of 6,000 Hz to about 40 to 45 dB at 100,000 Hz. False killer whales are somewhat more discriminatory at the lower frequencies. CR values increase from about 17 dB at 8,000 Hz to about 40 dB at 100,000 Hz. Measurements have not been obtained for either species at frequencies that are more representative of oceanic background noise, where the predominant frequencies of sound are below 5,000 Hz (Figure 7-1).

7.9 IMPACTS OF ANTHROPOGENIC NOISE ON MARINE ANIMALS

Anthropogenic noises can result in several types of impacts in marine animals. These can range from causing them to avoid favorable feeding or resting areas, interruption of feeding behavior, predator evasion, or social interactions, disorientation, physical damage to their auditory or balance organs and accompanying dysfunction, or death from physiological trauma. Generally any of these effects will be a consequence of high sound levels. Low-frequency sounds are of greatest concern in this regard because, since attenuation rates are proportional to frequency, the lower sounds propagate over greater distances and at higher intensities than higher frequency sounds (NRC 2000). ONR (2000) discusses species screening criteria for animals at risk of exposure to proposed sound sources. Those criteria have been adapted and expanded to more adequately evaluate the species and sound sources that apply to this project.

In order for an animal to be affected by a sound source, the animal must possess:

- A sensory mechanism that is sensitive to the frequency and sound level of sounds being produced by the source;
- A behavioral pattern that brings the animal into range of the sound source;
- A behavioral pattern (e.g., feeding or mating) that can be altered in the project area by exposure to frequencies emitted by the sound source, and
- Auditory sensitivity that is sufficiently low that the sound level of the sound is either obnoxious (causing avoidance or disruption in communications) or damaging.

In the case of endangered marine mammals or sea turtles, effects as minor as avoidance of areas customarily occupied for feeding, breeding, or resting prior to commencement of the activity in question or deviation from an established travel route are considered "takes" and are unlawful.

In order for an animal to be injured or killed by low-frequency sounds, the animal must possess:

- Some sensory mechanism that allows it to perceive low-frequency sounds or
- Tissues with a sufficient mismatch in acoustic impedance to be affected by transmission of low-frequency sounds from water to tissue or tissue to air. Such effects could include ruptured eardrums or hemorrhages in the inner and middle ear, all of which could be

catastrophic in marine vertebrates. Pulmonary complications are also possibly implicated in the case of high intensity low-frequency sounds.

ONR (2000) states,

“An acoustic impedance mismatch results when two dissimilar media (e.g., seawater and an air-filled cavity) exist side-by-side. The acoustic energy exiting from one medium must be transferred to the other medium. Since the media are dissimilar, the particles in the two media vibrate differently with the same amount of acoustic energy. The difference in the vibrations of these two media may stress or damage any connective tissues or barriers between the two media (Ketten, 1998).

Based on these considerations, a detailed analysis of only those organisms in the proposed ... site ... that meet the following criteria [are] undertaken in this document:

- Does the area receiving sound from the proposed sound source overlap the distribution of this species? If so,
- Is the species capable of being physically affected by [the sounds produced by the drills during installation or by operation of the wave energy generating system]? Are acoustic impedance mismatches large enough to enable these sounds to have a physical effect?
- Can the species sense LF sound?”
- Are any of the sounds produced for a sufficient duration to cause either physiological or behavioral effects on the species occurring in the area?

This final criterion is related to one of the first issues discussed in the “Workshop on the Effects of Anthropogenic Noise in the Marine Environment” (ONR 1998). Furthermore, the report had a number of relevant findings. The report stated,

“Regarding hearing, the following summarizes the major issues targeted in this section of the report: 1) Sounds of high intensity and/or long duration are known to cause physiological effects on the auditory system of terrestrial mammals and birds and there is evidence that such sounds can effect the ears of fishes. Effects may be temporary or permanent. Multiple exposures causing temporary hearing loss may ultimately result in permanent hearing loss, 2) Loss of hearing, whether it be temporary or permanent, can affect animals in a number of ways. As a minimal effect, a temporary loss could prevent an animal from detecting predator or prey, or result in the animal entering an area that would be dangerous for its survival. In addition to these effects, permanent loss of hearing could result in loss of an animal's ability to communicate with conspecifics, find mates, care for young, or find food. Over the long term, loss of hearing capabilities by large numbers of a species could lessen reproductive potential and survival of the species, 3) Permanent effects that are most readily seen clinically involve damage to the sensory hair cells (the mechanotransducers) in the inner ear. In mammals

these cells are not replaced once they are damaged, and damage to these cells results in permanent loss of hearing.

“Replacement does occur in birds and fishes, but it is not clear that their hearing returns to normal even with the new hair cells, 4) the aquatic environment has numerous natural sound sources, including wind on the surface, rain, shoaling waves, and seismic events. There are also substantial biological sources such as from snapping shrimp, fishes, and marine mammals that are significant sound sources within their own right. Sounds are widely used by aquatic animals in their everyday survival including foraging, detecting predators, finding mates, and caring for young, etc. Any sounds present in the environment that interfere with natural communication or perception of relevant sounds potentially compromise the survival of an animal, 5) There is a wide range of human-generated (anthropogenic) sounds in the aquatic environment. These include sounds produced by ships, for exploration, hydroelectric plants, etc. There is substantial evidence that the overall level of sound in the aquatic environment has increased significantly in the past 50 years and this is cause for concern vis a vis effects on aquatic organisms. At the same time, because the major increase is attributable to shipping, most added noise is likely to be below 500 Hz, and so the major effects of anthropogenic sounds may only be on those species that readily detect sounds at lower frequencies, 6) The effects of intense sound on the hearing of aquatic animals is not well known and has only been minimally investigated to date. However, there is evidence that temporary and permanent hearing loss occurs in dolphins and some pinnipeds, as well as in at least one species of fish. There are no data on the effects of sound on hearing capabilities of mysticete whales, or semi-aquatic mammals such as otters, 7) There are also almost no data on the effects of intense sounds on hearing by aquatic birds, reptiles, or invertebrates. The concern for hearing loss in these animals needs to be as great as it is for marine mammals since many of these species are of economic importance to humans and/or keystones in the marine food chain. Damage to hearing, and thus to the ability of these animals to survive, may affect the survival of other animals that interact or depend upon these species; 8) The levels of sounds needed to cause permanent hearing loss in aquatic mammals are not known. These levels are very hard to assess using behavioral techniques since it would be necessary to damage hearing capabilities in order to assess these effects. Other techniques are under development, including ABR and morphological methods, which may enable us to predict the levels of sound that will damage hearing based upon extrapolation of the effects from lower levels of sound stimulation.”

Finally, an important consideration is that little actual information exists on the effects and interactions of various frequencies and sound levels on marine vertebrates (Chapman and Ellis 1999). Extrapolating from the effects of acoustic trauma in humans to cetaceans, pinnipeds, or turtles is not justifiable.

7.10 POTENTIAL IMPACTS OF NOISE FROM WAVE-ENERGY GENERATION SYSTEM ON MARINE ANIMALS

Based on an analysis of the distribution patterns and sound reception capabilities of the potentially susceptible marine vertebrate species, it appears that the only species at potential risk and in need of analysis are:

- Humpback Whales
- Bottlenose Dolphins
- Hawaiian Spinner Dolphins
- Green Sea Turtles

7.10.1 Construction Noise

All of these species can sense sounds in the frequency range of the sound produced by the hydraulic drills. Sound levels typically decrease by ~40 dB at 100 m in water, i.e., a sound measured at 160 dB re 1 μ Pa at a distance of 1 m from the source will measure ~120 dB re 1 μ Pa 100 m away from the source. This is below the level that appears to affect any of the species listed here. Smith (2002) observed during construction activities involving drilling similar to those for the WET installation that marine life, turtles and fish in particular, were attracted to the activity, possibly by the bottom biota stirred up by the drilling. This suggests that the magnitude of the sound produced by the drills is not sufficient to alter behaviors of the species near the activity. Because of the short and intermittent nature of the noise produced by the drills during the construction phase of the project, it is unlikely that the noise will significantly disrupt feeding or other behaviors of these species.

7.10.2 Operating Noise

The WET system is expected to produce a continuous acoustic output with an amplitude approximately similar to that of “light” to “normal” shipping, with a spectral content shifted somewhat to higher frequencies than that of shipping. All of the species listed above can sense acoustic energy of this amplitude and frequency content. It is unlikely that this will have any noticeable impact on the behaviors of humpback whales, since these tend to become habituated to the noise produced by shipping. It is possible that dolphins may be attracted to the buoy site by their natural curiosity (as they often are with ships), but there are no aspects of the buoy design that present a possible threat of injury to the animals. There is no evidence in the literature that the amplitude and frequency of the noise produced by the WET system during operation will have an impact on either the porpoises or pinnipeds.

7.11 CONCLUSIONS

The noise produced by drilling during the construction phase of the project is localized, intermittent and of short duration. Although the species of interest for this assessment can sense sound of the magnitude and frequency content produced by the drills similar to those expected to be used for the installation operations, neither the amplitude nor the frequencies are sufficient to

constitute an impact on the species. No mitigation measures are required during the construction and installation phases of the project.

There are no field data yet available on the acoustic output of the WET system during operation. The noise produced by the system is expected to be similar to that from light to normal shipping in amplitude, with a frequency content somewhat higher than that due to shipping.

8 EFFECTS OF WET HEAT GENERATION

8.1 AMBIENT CONDITIONS AND WET HEAT SOURCES

The average ambient temperature of the seawater surrounding the WEC undersea power cable is 25.6 degrees Celsius ($^{\circ}$ C), with a range from 24.4 $^{\circ}$ C to 26.9 $^{\circ}$ C (Sea Engineering, 1985). The water in the relatively shallow depth at the WET site is in constant motion due to the wave action and currents.

The WEC components (cable, equipment canister, heat exchanger) are on the seafloor surrounded by the ambient seawater. There are several localized sources of heat due to operation of the WEC system. These are:

- The undersea power cable
- The equipment canister and its components during normal operations
- Load resistors during system shutdown or maintenance (located in/on equipment canister)
- Hydraulic Fluid Heat Exchanger (located near hydraulic cylinder)

8.2 SIGNIFICANCE CRITERIA

The effects of heating from any source on fauna can be expected to reflect the Van't Hoff-Arrhenius relationship between temperature and metabolism, that a 10 degree C increase in temperature will approximately double the metabolism of the organism, within the limits of ambient temperatures. Small changes that are within the naturally occurring range of ambient temperatures have correspondingly small effects on metabolism.

8.3 POWER CABLE

The resistive losses in the WEC undersea power cable result in the generation of heat in the cable and dissipation of this heat to the surrounding environment. The cable is laid on the surface of the seafloor.

8.3.1 WET Power Cable Heat Generation and Dissipation

The resistive losses in the WEC undersea power cable have been calculated to be from 20 milliwatts per foot of cable for a single buoy generating 20 kW of power, to approximately 1.4 Watts per foot of cable in the case of up to six buoys generating 250 kW (Stewart and Welsh, 2002; Thom and Powers, 2002). Based on the calculated resistive losses, the temperature rise in

the cable has been estimated to range from less than 0.01°C for a single buoy to less than 0.023°C for six buoys (Thom and Powers, 2002).

8.3.2 Impacts Due to Heat Dissipation

The WET power cable is laid on the surface of the seafloor, exposed to the surrounding seawater. The water in the vicinity of the cable is expected to be in constant motion and thus well mixed. Because of the motion of the water, any heat convected from the cable will be dissipated essentially instantaneously. Heating of the seawater in the immediate vicinity of the cable is negligible, due to the small heat rise in the cable, the efficient transfer of what heat there is to the surrounding seawater, and the mixing of the water due to wave and current action. Because of the very large volume of seawater around the cable, any localized heating will produce differences in temperature of the water less than the natural differences due to solar heating, upwelling, and current-induced mixing. Although the WET cable is in contact with the seafloor, the thermal resistivity of the sediments or other seafloor material is substantially higher than that of the seawater. Thus, it can be expected that negligible heat will be transferred directly into the seabed materials.

8.3.3 Issues

There are several potential issues related to heat dissipation from the WEC undersea power cable.

- Thermal effects on species composition and diversity, population, and productivity of seafloor and benthic flora and fauna
- Indirect effects on demersal species due to any changes in seafloor and benthic flora and fauna
- Thermal effects on water quality

8.3.4 Impact Assessment

Benthic Flora and Fauna: Because the heat from the cable is dissipated quickly and completely by the natural flow of seawater around the cable, the temperature rise in the seafloor materials is negligible. No impact on seafloor or benthic flora or fauna is expected.

Demersal Fauna: Since no impacts due to heat from the cable are anticipated on the benthic flora or fauna, no impacts on demersal species are expected.

Water Quality: Since no measurable increase in the water temperature around the cable is anticipated, no impacts on water quality are expected.

8.3.5 Mitigation

Resistive power losses are inherent in power cables, and dissipation of the resulting heat is an unavoidable result of electric current flow through the cable. No mitigative measures are

proposed or recommended for changes in the WEC undersea power cable design to reduce or avoid the resistive heating of the cable.

8.4 EQUIPMENT CANISTER

8.4.1 Equipment Canister Heat Generation and Dissipation

Under normal system operation, the hydraulic motor, generator and electrical transformer all generate small amounts of heat due to mechanical and electrical inefficiencies. These components are located inside the equipment canister, a cylindrical steel structure mounted on the sea floor. The heat generated by these components transfers through the surrounding air environment into the steel shell and into the surrounding water. The heat rejection from the canister was derived by first estimating the heat loss due to the inefficiencies of each of the three main components. The heat conduction from the steel canister into surrounding water then was calculated using a standard method for calculating heat transfer (Sabol and Powers, 2002). The resulting temperature change for a single buoy is approximately 0.02°C to 0.12°C for six buoys. This analysis assumed quiescent water surrounding the canister, a very conservative assumption. The temperature rise in the constantly moving water at the project site will be negligible.

8.4.2 Issues

There are several potential issues related to heat dissipation from the WET equipment canister.

- Thermal effects on species composition and diversity, population, and productivity of seafloor and benthic flora and fauna
- Indirect effects on demersal species due to any changes in seafloor and benthic flora and fauna
- Thermal effects on water quality

8.4.3 Impact Assessment

Benthic Flora and Fauna: Because the heat from the equipment canister is dissipated quickly and completely by the natural flow of seawater around the canister, the temperature rise in the seafloor materials is negligible. No impact on seafloor or benthic flora or fauna is expected.

Demersal Fauna: Since no impacts due to heat from the canister are anticipated on the benthic flora or fauna, no impacts on demersal species are expected.

Water Quality: Since no measurable increase in the water temperature around the canister is anticipated, no impacts on water quality are expected.

8.4.4 Mitigation

Mechanical and electrical inefficiencies and the associated losses and heat generation are inherent in systems, and dissipation of the resulting heat is an unavoidable result of the power

generation and conversion. No mitigative measures are proposed or recommended for changes in the WET system design to reduce or avoid the heating of the equipment canister.

8.5 LOAD RESISTORS

8.5.1 Load Resistor Heat Generation and Dissipation

During partial system shutdown or maintenance activities, electric power is diverted from the transformer and cable by means of a switch, diverting the power to a bank of load resistors, where the electrical power is resistively dissipated, generating heat in the process. This feature is part of the safety system that allows shunting of the power off the cable if a system anomaly is observed or if maintenance is required. This is anticipated to occur only infrequently, perhaps once or twice per month. The load resistors can dissipate as much as the full 40 kW of power in a two-buoy system. The heat generated is transferred to the seawater. In the current canister design, the load resistors are in the form of electrically resistive element bands mounted to the outside diameter of pipe sections that allow seawater to flow through them (Sabol and Powers, 2002). Three pipe sections 182 mm in diameter can each transfer as much as 14.4 kW of heat. The heat from the resistive elements heats the steel pipe, and the thermal transfer to the water sets up a convective flow of seawater through the pipes. When the load resistors are activated, the water temperature of the exiting flow will increase. The thermal calculations used standard heat transfer calculations to determine the heat flux through the steel pipe (the inner pipe design was modeled as a plate) and into the seawater. A convective flow rate of 5.5 cubic meters per minute was calculated for two buoys producing 40 kW of power (Sabol and Powers, 2002). The final design of the heat exchanger for this feature is not complete. An external design concept (heat exchanger tubes outside the canister) may be utilized so that the heat is dissipated in a conventional finned tube on the outside in lieu of the inner pipe design. This would increase the surface area and reduce localized heating density. In either case, the amount of total heat transfer to the seawater would be similar. With the full water flow through the load resistor heat exchanger, but with no mixing with external seawater, the maximum temperature difference from ambient is estimated to be about 57.3°C. Several factors should be noted. First, this is an infrequent transient effect, occurring only during system faults or maintenance. Second, the temperature differences calculated in Sabol and Powers (2002) were based on quiescent ambient conditions. The continual movement of water around the load resistor heat exchanger will reduce the temperature of the water exiting the exchanger to ambient very quickly because of the volume of seawater surrounding the assembly. Thus, the temperature rise at the seafloor is negligible.

8.5.2 Issues

There are several potential issues related to heat dissipation from the WEC load resistor heat exchanger.

- Thermal effects on species composition and diversity, population, and productivity of seafloor and benthic flora and fauna
- Indirect effects on demersal species due to any changes in seafloor and benthic flora and fauna

- Thermal effects on water quality

8.5.3 Impact Assessment

Benthic Flora and Fauna

Because the heat from the load resistors is dissipated quickly and completely by the natural flow of seawater around the heat exchanger, the temperature rise in the immediate vicinity of the heat exchanger is expected to be small. The temperature rise at the seafloor is expected to be negligible. No impact on seafloor or benthic flora or fauna is expected.

Demersal Fauna

The load resistors will cause a small, localized temporary increase in the temperature at the exit of the heat exchanger tubes. The temperature rise is considered to be small enough and the duration short enough that no effect on demersal fauna is expected. No impacts due to heat from the load resistor heat exchanger are anticipated on the benthic flora or fauna, and no impacts on demersal species are expected.

Water Quality

The temperature rise at the heat exchanger exit is considered to be small enough and the duration short enough that only a transient increase in the water temperature around the load resistor heat exchanger is anticipated. No impacts on water quality are expected.

8.5.4 Mitigation

The nature of the WEC system requires that the electrical load be capable of being shunted to load-dissipating resistors for periods of system anomalies and maintenance, and dissipation of the resulting heat is an unavoidable result of the power generation and conversion. No mitigative measures are proposed or recommended for changes in the WEC system design to reduce or avoid the heating due to the shunt resistors.

8.6 HYDRAULIC FLUID HEAT EXCHANGER

8.6.1 Hydraulic Heat Exchanger Heat Generation and Dissipation

The hydraulic circuit in the WEC system includes a single pass, six tube, cross flow heat exchanger. This transfers excess heat from the hydraulic fluid to the surrounding seawater. The heat exchanger is located near the hydraulic cylinder. During operation, the hydraulic fluid in the power conversion system is heated due to friction and pressure losses in the hoses, pipes, valves, and other flow restrictions. This heat must be dissipated to maintain the temperature of the fluid and equipment within the operating parameters of the system, particularly during extreme conditions (e.g., storm conditions, when the significant wave height is greater than 5 meters, which would occur an estimated 0.06% of the time for the proposed site location). A thermal analysis was conducted by first estimating the flow and pressure of the hydraulic fluid under the

flows and pressures experienced during storm conditions, when the buoy is applying increased force and velocity to the hydraulic cylinder. The analysis is presented in Sabol and Powers (2002). Hydraulic flow in excess of the maximum power that the motor and generator can absorb is diverted to the heat exchanger. The heat exchanger is designed to dissipate 73 kW per buoy, or 146kW for a two-buoy installation. The heat transfer to the surrounding seawater was then calculated using standard techniques that determine the rate of heat transfer through the walls of the pipe of the heat exchanger. This analysis assumed convective flow around the heat exchanger tubes in quiescent water. This resulted in a temperature rise of 0.84°C at the surface of the heat exchanger tubes. In the environment at the project site, the water is in constant motion, transferring and dissipating the heat substantially more efficiently than in quiescent conditions. This will reduce the exchanger surface temperature well below that calculated in Sabol and Powers (2002), to negligible levels under normal operating conditions, and to a level below significance in storm conditions.

8.6.2 Issues

There are several potential issues related to heat dissipation from the WEC hydraulic system heat exchanger.

- Thermal effects on species composition and diversity, population, and productivity of seafloor and benthic flora and fauna
- Indirect effects on demersal species due to any changes in seafloor and benthic flora and fauna
- Thermal effects on water quality

8.6.3 Impact Assessment

Benthic Flora and Fauna

Because the heat from the hydraulic system is dissipated high in the water column quickly and completely by the natural flow of seawater around the heat exchanger, the temperature rise in the immediate vicinity of the heat exchanger is expected to be insignificant. Since the heat exchanger is located in the water column, there is no temperature rise at the seafloor. No impact on seafloor or benthic flora or fauna is expected.

Demersal Fauna

The hydraulic heat exchanger will cause a small, localized increase in the temperature at the surface of the heat exchanger tubes. The temperature rise is considered to be negligible, and no effect on demersal fauna is expected. No impacts due to heat from the hydraulic system heat exchanger are anticipated on demersal species.

Water Quality

The temperature rise at the heat exchanger surface is considered to be small enough and the duration short enough that only a transient increase in the water temperature around the hydraulic system heat exchanger is anticipated. No impacts on water quality are expected.

8.6.4 Mitigation

The nature of the WEC system requires that the hydraulic system be capable of dissipating excess heat, particularly during high-energy (e.g., storm) conditions, and dissipation of the resulting heat is an unavoidable result of the power generation and conversion. No mitigative measures are proposed or recommended for changes in the WEC system design to reduce or avoid the heating due to the hydraulic system.

9 POTENTIAL FOR MARINE ANIMAL ENTANGLEMENTS OR OTHER INTERACTION WITH THE WET SYSTEM

9.1 INTRODUCTION

The presence of equipment and cables in the marine environment occasionally has been considered to pose a potential risk to marine mammals of entanglement with the cables. In addition, because of the physical nature of the WEC components, there is a possibility that aquatic animals might enter the bottom of the WEC buoy and become trapped or disoriented. This analysis reviews the available literature on these issues and assesses the risks to marine mammals posed by the WET installation off O'ahu, Hawai'i.

9.2 REVIEW OF LITERATURE ON MARINE MAMMAL ENTANGLEMENT

Literature concerning the entanglement of marine mammals with submarine cables is limited. Heezen (1957) presents accounts of fourteen instances of whales entangled in submarine cables. The accounts include reports during the time frame of 1878-1955. Ten of the entanglements took place along the Pacific Ocean coast of South and Central America, with the others distributed in other parts of the world. All of the whales that could be positively identified were sperm whales (*Physeter catodon*), which are toothed whales. In some instances, the species of whale could not be identified due to advanced decomposition. These entanglements frequently were found in proximity to known sites of repairs to the cables. According to Heezen's paper, "This probably means that there was extreme slack in the cable at these points." Heezen concluded that the sperm whales often swim along the sea floor and that entanglement with the lower jaw can occur during feeding in the sediment. It was also noted that the whales could possibly mistake the slack cable as a food item and attack the cable and then become entangled (Heezen, 1957). It has been thought also that the pile of cable acted as a habitat for species of feeding interest to the whales. All of Heezen's reported entanglements occurred in water substantially deeper than the WET project site. In fact, the initial objective of Heezen's research was to investigate the depths to which whales dive.

Heezen and Johnson (1969) researched the records of the Alaska Cable System, a telegraph cable system that was laid on the Alaskan continental shelf beginning in the early 1900s by the U.S. Government War Department. At its maximum, the cable system ran from Puget Sound to the Alaskan Panhandle and westward along the Aleutian Islands. The cable system, or portions thereof, was operational from 1900 to 1960, with a brief period of abandonment in the early forties. Only two of the hundreds of system interruptions that occurred during the history of the Alaska Cable System were attributed to whale entanglements. The others resulted primarily from geological events (earthquakes and submarine landslides), chafing by abrasive materials, and anchor damage (Heezen and Johnson, 1966, 1969). No published literature has reported marine mammal or other marine animal entanglements in undersea cables since 1955.

For this study, detailed searches of commercial and government cable fault databases were made. These searches have yielded no reports of marine mammal entanglements. An Internet search likewise revealed no information on whale entanglements or other mammal encounters with submarine cables.

Individuals in the commercial submarine cable industry or associated with government undersea cable were contacted for any information they might have related to whale or other marine mammal encounters with undersea cables (Drew, 2002; Herrmann, 2002). Uniformly, these individuals stated that to their knowledge, there have been no mammal or other animal encounters with undersea cables since those reported by Heezen.

9.3 MODERN CABLE INSTALLATION

Modern submarine cable systems are quite different than those that were installed during the nineteenth and first half of the twentieth century. Major technological advances in cable manufacturing, installation and marine navigation have been made in the last forty years. These have substantially improved the industry's ability to lay cable in and on the sea floor. Cable burial technology with seafloor cable burial machines and other equipment, developed in the 1980s, provides for added protection of the system and prevents exposure of the cables to marine mammals.

Old cable steamers relied on the standard navigation equipment of their day (mainly sextant and dead reckoning) to lay cables on the surface of the seafloor. They generally lacked detailed information about the shape of the seabed, and they lacked the means for precise navigation. Consequently, they often installed cable with considerable slack. This created the potential for loops standing above the seabed, suspensions over depressions in the seafloor, and possible marine mammal entanglements.

Modern cable installations are guided by the most technologically advanced navigation systems available. All ships that install cables, whether or not they are conventional cables, now use Differential Global Positioning System (DGPS) navigation, or an equivalent, to achieve very precise installations. High resolution sonar surveys and bottom sampling provide very detailed information about the shape and composition of the seabed. Modern cable systems are designed, manufactured and installed for specific routes, and with minimal allowance for slack. Cable slack is carefully controlled, both when laying cable on the seafloor and when plowing (burying), so that the installed cable conforms to the shape of the bottom without being slack enough to

allow loops. Should a repair become necessary on a continental shelf, the repaired section is lowered to the seabed carefully and buried with a Remotely Operated Vehicle (ROV) wherever seabed conditions permit. Excessive slack and loops are avoided.

Advances in cable manufacturing also have contributed to the improved installations. Some early cable was unable to withstand significant tensions, and so was purposely laid with excess slack to reduce the risk of cable failures. Despite this precaution, cable breaks occurred, and repairs generally resulted in additional slack, and often loops, being put into the system, thereby increasing the potential for entanglements (Heezen, 1957).

9.4 ASSESSMENT OF ENTANGLEMENT RISK FOR WET CABLE

Based on the available literature, unpublished reports and discussions with individuals active in both commercial and government cable projects, the incidence of marine mammal entanglements on marine cables has been very rare. Considering the number of systems worldwide, comprising hundreds of thousands of kilometers of cables in the ocean, and the period of time over which these systems have been monitored, there are extremely few recorded instances of whale entanglements in undersea cables. For example, the Alaska Cable System records from 1900 to 1960 document hundreds of cable failures, only two of which were the result of whale entanglements (Heezen and Johnson, 1969).

Extensive literature searches conducted for this study have yielded no accounts of marine mammal entanglements in, or encounters with, submarine communications cables since the nineteen fifties. Moreover, detailed examination of commercial and government databases of cable faults containing over nine hundred fault records worldwide dating back to the nineteen-sixties has yielded no indications of marine mammal entanglement with bottom laid cables. There are no instances at all in any of the cable installation records of interactions by marine mammals of any species with cables as they were being installed.

While there are historic records of whales entangled in surface-laid submarine cables, these incidents appear to involve situations where bottom-feeding whales encountered old cable systems installed in deep water in the late nineteenth and early twentieth centuries. Since then, major technological advances in navigation, cable manufacture and installation have substantially changed and improved how cable is placed on the seafloor. Unlike the early cable systems, the systems of today are installed with only enough slack to conform to the profile of the seabed. Modern cable systems are either buried beneath or laid in close contact with the sea floor, and therefore present negligible risk for marine mammal entanglement.

The WEC baseline cable design is a single or double armor configuration with one or two layers of steel wires and a synthetic coating. The outer diameter is about 2.6 inches (66mm). The cable is intended to be torque balanced and resistant to forming loops. The cable will be installed with adequate slack to allow it to contour the seafloor without suspensions, and offers negligible potential for marine mammal entanglement. The WEC undersea cable is quite short, about 3900 ft (1190 m) long. The installation is anticipated to require less than two days, resulting in very limited temporal exposure of the cable in the water column. In addition, the cable is installed in shallow water. The species of concern that may appear in the WET project area are the Hawaiian monk seal (*Monachus schaninlandi*) and the humpback whale (*Megaptera novaeangliae*). Both

species have been reported to be highly transient in the project area. Because of the very limited duration of the WEC undersea cable installation operations, and the fact that the cable will lie flat on the seafloor, the risk of these species encountering or becoming entangled in the WEC undersea cable is considered negligible.

9.5 MITIGATION

Mitigation measures for the installation operations will be determined in consultation with the appropriate agencies.

9.6 INTERACTION OF OTHER MARINE ANIMALS WITH THE WET EQUIPMENT

As described in Section 5.1 and shown in Figure 5.2, the WEC buoy is a large cylinder open at the bottom end. There are no flat or “shelf” areas that might provide areas for animals to rest on. It is possible that animals could enter the open end of the buoy. A review of the available literature on habitats and behaviors of species of concern in the project area was made in an effort to assess this risk and potential impact. In addition, sea turtle researchers were contacted for opinions on this issue. Driskell (2002) noted that one or two species of sea turtles rest in reef caves (including the Hawksbill [*eretmochelys imbricata*]), but that these species have not been observed in the project area. This was confirmed by the Pacific Hawksbill Turtle Recovery Plan (NMFS/FWS 1998).

9.6.1 Issues

The potential issues with the installation of the WEC buoy are the possibility of entrapment of an animal inside the buoy or disorientation of an animal after entering the open bottom of the buoy.

9.6.2 Impact Assessment

The interior design of the buoy has been assessed for snag or entrapment hazards. As noted previously in Section 5.1 and Figure 5-2, there are no horizontal flat surfaces that might be attractive for animals to rest on. In addition, because the rib, stringers and spider assemblies are round and there are no corners or sharp edges, they do not present snag hazards. The steel skin is attached tightly to the ribs and stringers, presenting no gaps or other opportunities for snagging or entrapment. The design of the buoy is such that there do not appear to be any hazards to sea turtles should they enter the buoy. The bottom of the buoy is open and unobstructed. During daylight hours, there will be a substantial amount of light at the open end of the buoy, providing a means for animals to orient themselves to the exit from the buoy. It should be noted also that the buoy is in constant motion, discouraging animals from entering the buoy. The size of the opening in the bottom of the WEC buoy, while providing an ingress path for sea turtles, also provides a ready egress path. The interior of the buoy is free of entanglement or snagging obstructions. There appears to be no impact on sea turtles from the presence of the WEC buoys.

9.6.3 Mitigation

No mitigation measures are needed or proposed.

10 LIST OF CONTRIBUTORS

William B. Driskell
Marine Biologist
Seattle, WA

Dennis C. Lees
Littoral Ecological and Environmental Services
Leucadia, CA

Dallas Meggitt
Sound & Sea Technology
Edmonds, WA

11 REFERENCES

- Association of Diving Contractors International (ADC 2000). Concensus Standards for Commercial Diving Operations, Incorporating Interim Change 1 and New Chapter 7, New Orleans LA, 2000
- AT&T 1968: AT&T Bell Laboratories, Internal Report X-76063, "Submarine Cable Probe Fault Localization System," Whippany NJ, March 1968
- Bader, B. 1996. Shark sensory capabilities. Shark parts: Biology of super predators. Seascope online magazine- a WWW publication at <http://www.qni.com/~cperezi/biology.html>.
- Balayev, L. A. and N. N. Fursa 1980: "Behavior of Ecologically Different Fish in Electric Fields, I. Threshold of first reaction in fish." Journal of Ichthyology v. 20 no. 4: 147-152.
- Balcomb, K. C., III. 1987. The Whales of Hawaii including all species of marine mammals in Hawaiian and adjacent waters. A Publication of the Marine Mammal Fund. San Francisco, CA. 97 pp.
- Basslink 2002: Basslink Project, Final Environmental Impact Statement and Supplement to the Draft Integrated Impact Assessment Statement, Appendix E, Marine Impact Assessment. Prepared by NSR Environmental Consultants, Victoria, Australia June 2002. 144 pgs.
- Bodznick, D., G. Hjelmstad, M. Bennett 1993: Accommodation to maintained stimuli in the ampullae of Lorenzini: how an electroreceptive fish achieves sensitivity in a noisy world, Japanese Journal of Physiology, 43(1.1):s231-s237
- Bullock, T. H. 1982: Electroreception. Annual Review of Neuroscience 5:121-70.

Bullock, T.H., R.G. Northcutt and D.A. Bodznick 1982: Evolution of electroreception. *Trends in Neuroscience* 5:50-53.

Carey, F.G. and J.V. Scharold 1990: Movements of blue sharks (*Prionace glauca*) in depth and course. *Marine Biology* 106, 329-342.

Chapman, D. F. M., and D. D. Ellis. 1999. The elusive decibel: Thoughts on sonar and marine mammals. *Currents*, A Publication of the Oceanic Resource Foundation Dedicated to the Protection of the Marine Environment. Winter 98-99:2-3 and 8.

Currie, D. 2002: Personal communication, Department of Zoology, University of Washington.

Deutschlander, M.E., J.B. Phillips And S.C. Borland, 1999: The Case For Light-Dependent Magnetic Orientation In Animals. *Journal of Experimental Biology* 202, 891-908.

Dijkgraaf, S. and A. J. Kalmijn 1962: Verhaltungsversuche zur Funktion der Lorenzinischen, Ampullen. *Naturwissenschaften* 49:400.

Dijkgraaf, S. and A.J. Kalmijn 1966: Versuche zur biologischen Bedeutung der Lorenzinischen Ampullen bei den Elasmobranchiern. *Z. Vergl. Physiol.* 53: 187-194.

Drew, S. 2002: Personal Communication. April 9, 2002. Tyco Submarine Systems, Ltd., Morristown, New Jersey.

Drigot, D. C., Wilcox, B. A., and Duin, K. N. 2001: Marine Corps Base Hawaii Integrated Natural Resources Management Plan/Environmental Assessment (MCBH INRMP/EA), Environmental Department, Marine Corps Base Hawaii

Driskell, William B. 2002: Behavior of Sea Turtles, personal communication, 22 June 2002

Enger, P.S. 1992: Electroreception. In *Fish Physiology*. K. Davings and E. Reimers, eds. Pp130-139, John Grieg Publishing, Bergen Norway.

Enger, P.S., L. Kristensen, and O. Sand 1976: The perception of weak electric D.C. currents by the European eel (*Anguilla anguilla*). *Comparative Biochemistry and Physiology* 54A, 101-103.

Fields, R., T. Bullock, G. Lange 1993: Ampullary sense organs, peripheral, central, and behavioral electroreception in Chimeras. *Brain, Behavior, and Evolution*, vol. 41, pgs. 2169-289

Hain, J. H. W., Ellis, S. L., Kenney, R. D. et al. 1995: "Apparent Bottom Feeding by Humpback Whales on Stellwagen Bank." *Marine Mammal Science* 11(4) 464-479

Heezen, B. C. 1957: "Whales Entangled in Deep Sea Cables." *Deep Sea Research* 4: 105-115.

Heezen, B. C. and G. L. Johnson 1966: "Cable Failures in the Alaska Cable System," Lamont Geological Observatory for the Bell Telephone Laboratories, New Jersey, 1966, 170pp.

Heezen, B. C. and G. L. Johnson 1969: "Alaskan Submarine Cables: A Struggle with a Harsh Environment." *Arctic*. 22 (4): 413-424.

Henderson, R. Scott 1992: A Natural Resources Survey of the Nearshore Waters of Molapu Peninsula, Kaneohe Marine Corps Air Station, val Command, Control and Ocean Surveillance Center, Kailua, HI

Herrmann, H. G. 2002: Personal Communication. April 9, 2002. Naval Facilities Engineering Service Center, Washington, D.C.

Hutchins, E. 1999: Personal Communication. December 2, 1999. NOAA, National Marine Fisheries Service, Habitat Section, Gloucester, Massachusetts.

John J. McMullen Associates, Inc. 1984. Evaluation of three Stanley hydraulic rock drills for use by divers. Prepared for Naval Civil Engineering Laboratory, Report No. CR 84.020. 47 pp.

Kalmijn, A.J. 1971: The electric sense of sharks and rays. *Journal of Experimental Biology*. 55: 371-383.

Kalmijn, A.J. 1982: Electric and magnetic field detection in elasmobranch fishes. *Science* 218: 916-918.

Kastak and Schusterman. 1998.

Ketten, 1998

Kirschvink, J.L., M.M. Walker and C.E. Diebel 2001: Magnetite-based magnetoreception. *Current Opinion in Neurobiology* 2001, 11:462-467

Klinowska, M. 1986: The cetacean magnetic sense - evidence from strandings. In: *Research on Dolphins*. eds, M. M. Bryden & R. Harrison, pp. 401-432. Oxford University Press, Oxford.

Lohmann, K.J., and S. Johnsen 2000: The neurobiology of magnetoreception in vertebrate animals. *Trends in Neurosciences* 23, 153-159.

Lohmann, K.J., J.T. Hester, and C.M.F. Lohmann. 1999: Long-distance navigation in sea turtles. *Ethology, Ecology, and Evolution*. 11: 1-23.

Lorenzini, S. 1678: *Osservazioni intorno alle Torpedini*. vol 1. Firenze. 136 pp.

Marino, A.A. and R.O. Becker 1977: Biological effects of extremely low frequency electric and magnetic fields: a review. *Physiol. Chem. Phys.* 9:131-147, 1977.

Murray, R. W. 1974. The Ampullae of Lorenzini: In: *Handbook of Sensory Physiology*, A. Fessard, (ed). Springer-Verlag, New York.

Murray, R.W. 1960: Electrical sensitivity of the ampullae of Lorenzini. *Nature* 187, 957.

Murray, R.W. 1962: The response of the ampullae of Lorenzini in elasmobranchs to electrical stimulation. *J. Exp. Biol.* 39:119–128.

National Marine Fisheries Service and U.S. Fish and Wildlife Service. 1998 (NMFS/FWS 1998): Recovery Plan for U.S. Pacific Populations of the Hawksbill Turtle (*Eretmochelys imbricata*). National Marine Fisheries Service, Silver Spring, MD.

National Research Council (NRC). 2000. Marine Mammals and Low-Frequency Sounds – Progress since 1994, National Academy Press. Washington, D.C. 146 pp.

Office of Naval Research (ONR). 1998. Proceedings – Workshop on the Effects of Anthropogenic Noise in the Marine Environment. 10-12 February 1998. Prepared by Robert C. Gisiner, Ph.D., Marine Mammal Science Program, Office of Naval Research. 145 pp.

Office of Naval Research (ONR). 2000. Draft Environmental Impact Statement for the North Pacific Acoustic Laboratory. May 2000. Prepared by ONR with cooperation of NOAA NMFS and State of Hawaii, Dept. of Land and Natural Resources.

Olayvar, G. K. 2002: Marine Mammal and Sea Turtle Observations off Mokapu Peninsula, personal communication, June 30, 2002

O'Hara and Wilcox, 1990

Paulin, Michael 1995: Electroreception and the compass sense of sharks, *Journal of Theoretical Biology*, 174:325-339.

Poléo, A.B.S., H. F. Johannessen, M. Harboe Jr., 2001: High Voltage Direct Current (Hvdc) Sea Cables And Sea Electrodes: Effects On Marine Life; 1st revision of the Literature Study. University of Oslo, Norway. 50 pgs.

Popper and Fay, 1993

Rapp, Ron 2002: Recent Trends in Submarine Cable Faults, personal communication, June 2002, Tyco Telecommunications Ltd.

Richardson, W. J., C. R. Greene, Jr., C. I. Malme, and Denis H. Thomson. 1995. Marine Mammals and Noise. Academic Press, New York. 576 pp.

Ridgway et al., 1969;

Sabol, Thom, and W. Powers 2002: Engineering Report – PHEPS System Thermal Analysis, Ocean Power Technologies, Inc. Engineering Report, 17 June 2002

Schulten, K. and A. Windemuth 1986: Model for a physiological magnetic compass. In *Biophysical Effects of Steady Magnetic Fields* (ed. G. Maret), pp. 99–106. Berlin: Springer-Verlag.

Sea Engineering, Inc. 1985: Kealakehe Ocean Outfall Ocean Data Collection and Analysis Final Report, Sea Engineering for R. M. Towill Corporation, May 1985

Skeleton Reef 2000. Marine sharks: electroreception. A WWW publication at http://skeletonreef.com/sharks_six_senses.htm. [no longer available]

Smith, Stephen H. (2002). E-mail personal communication to G. S. Kasaoka and K. Kendall, July 24, 2002

Stepanuk, I. 1988. Marine animals and electromagnetic fields. *Morskoy Sbornik*. 2:76-78. Translation for government review. 2001. DSTO MOD Sydney. 77-81.

Stewart, David and T. Welsh 2002: PHEPS Undersea Cable Power Characteristics, Ocean Power Technologies, Inc. Report No: ENG-11-007, 25 April 2002

Stocker, Michael 2002. Michael Stocker Associates, Air-Water dB Table, Personal Communication, August, 2002

Tricas, T.C. 2001: The neuroecology of the elasmobranch electrosensory world: why peripheral morphology shapes behavior. *Environmental Biology of Fishes*. 60: 77-92.

Tricas, T.C. and New, J.G. 1998: Sensitivity and response dynamics of elasmobranch electrosensory primary afferent neurons to near threshold fields. *Journal of Comparative Physiology A*. 182: 89-101.

Tucker, L.W. 1982: "Safe Under Water Electrical power Transmission" Civil Engineering Laboratory, TR-R896, August 1982

Tucker, L. W. 2002a: Calculation of Magnetic and Electric Fields Near WET Power Cable, Informal Memorandum, April 20, 2002

Tucker, L. W. 2002b: Estimation of Heat Rise in WET power Cable, personal communication, May, 2002

Westerberg, H. and M.L. Begout-Anras 1999. Orientation of silver eel (*Anguilla anguilla*) in a disturbed geomagnetic field. Third Conference on Fish Telemetry in Europe. 20-25 June 1999, Norwich, United Kingdom.

Wenz, G. M. 1962. Acoustic ambient noise in the ocean: Spectra and sources. *J. Acoust. Soc. Am.* 34(12): 1936-1956.

Willows, A.O.D. 1999: Shoreward orientation involving geomagnetic cues in the nudibranch mollusk *Tritonia diomedea*. *Marine and Freshwater Behavioural Physiology* 32, 181-192.

Wiltschko, R. and Wiltschko, W. 1995: Magnetic orientation in animals. *Zoophysiology*, vol. 33, pp. 1-297. Berlin: Springer-Verlag.

Appendix G

Material Safety Data Sheets



SAFETY DATA SHEET

ABC # 3 ANTIFOULING RED

ABC # 3 ANTIFOULING RED

1 Identification of the substance/preparation and of the company/undertaking

Product name : ABC # 3 ANTIFOULING RED
 Product Code : V028301
 Applications : For professional use only. Refer to Technical Data Sheet for further information.
 Supplier/ Manufacturer : Ameron BV Protective Coatings Group
 J.F.Kennedylaan 7
 P.O. Box 8, 4180 CA, Geldermalsen, The Netherlands

Telephone No. : +31 345 587567
 Fax : +31 345 587551
 Emergency phone : +31 345 587567

2 Composition and Information on Ingredients

Substance/Preparation : Preparation

Preparation : Coatings: Ablative Antifouling

Europe Ingredient Name*	CAS No.	%	Symbol	R-Phrases
1) Colophony	8050-09-7	5-10	Xi	R43
2) Xylene	1330-20-7	10-30	Xn	R10, R20/21, R38
3) Ziram	137-30-4	1-5	Xn	R22, R36/37/38, R40
4) Butanol	78-83-1	10-30	Xi	R10, R37/38, R41
5) Dicopper oxide	1317-39-1	30-60	Xn	R22

Preparation comments : Substances presenting a hazard within the meaning of the Chemicals (Hazard Information and Packaging) Regulations 1993 and subsequent amendments (Directives 87/548/EEC, 88/379/EEC).

* Occupational Exposure Limit(s), if available, are listed in section 8

3 Hazards Identification

Physical/chemical hazards : Flammable.

Human health hazards : Harmful if ingested.
 Irritating to skin.
 Possible risks of irreversible effects.
 Risk of serious damage to eyes.
 May cause sensitization by skin contact.

Environmental hazards : Not applicable.

4 First-Aid measures

General : In all cases of doubt, or when symptoms persist, seek medical attention. Never give anything by mouth to an unconscious person.

Inhalation : If inhaled, remove to fresh air. If not breathing, give artificial respiration. If breathing is difficult, give oxygen. Get medical attention.

Ingestion : Do NOT induce vomiting unless directed to do so by medical personnel. Never give anything by mouth to an unconscious person. If large quantities of this material are swallowed, call a physician immediately. Loosen tight clothing such as a collar, tie, belt or waistband.

Skin Contact : In case of contact, immediately flush skin with plenty of water for at least 15 minutes while removing contaminated clothing and shoes. Cover the irritated skin with an emollient. Wash clothing before reuse. Thoroughly clean shoes before reuse. Get medical attention.

Page: 1/5

Eye Contact : Check for and remove any contact lenses. In case of contact, immediately flush eyes with plenty of water for at least 15 minutes. Get medical attention immediately.

5 Fire-Fighting Measures

Extinguishing Media

Suitable : Flammable liquid.
 SMALL FIRE: Use DRY chemical powder.
 LARGE FIRE: Use alcohol foam, water spray or fog. Sand, Carbon Dioxide (CO₂). Do not use water jet.

Special fire-fighting procedures : Decomposition products thermal decomposition may release hazardous gases. Fire fighters should wear positive pressure self-contained breathing apparatus (SCBA) and full turnout gear. Use water spray to keep fire exposed containers cool. Prevent entry into sewers, basements or confined areas; dike if needed.

6 Accidental Release Measures

Environmental Precautions and Clean-up Methods : Flammable liquid.
 Keep away from heat. Keep away from sources of ignition. Stop leak if without risk. Absorb with DRY earth, sand or other non-combustible material. Do not touch spilled material. Prevent entry into sewers, basements or confined areas; dike if needed. Be careful that the product is not present at a concentration level above TLV. Check TLV on the MSDS and with local authorities.

7 Handling and Storage

Handling : Keep locked up. Keep away from heat. Keep away from sources of ignition. Ground all equipment containing material. Do not ingest. Do not breathe gas/fumes/vapor/spray. Avoid contact with skin and eyes. Wear suitable protective clothing. If ingested, seek medical advice immediately and show the container or the label. Eating, drinking and smoking should be prohibited in area where this material is handled, stored and processed. Workers should wash hands and face before eating, drinking and smoking.

Storage : Store in a segregated and approved area. Keep container in a cool, well-ventilated area. Keep container tightly closed and sealed until ready for use. Avoid all possible sources of ignition (spark or flame). Do not store below 5°C or above 40°C. Store away from direct sunlight. This product should be stored away from oxidizing materials and strong bases/acids.

8 Exposure Controls and Personal Protection

Engineering measures : Provide exhaust ventilation or other engineering controls to keep the airborne concentrations of vapors below their respective threshold limit value. Ensure that eyewash stations and safety showers are proximal to the work-station location.

Ingredient Name Occupational Exposure Limits

United Kingdom (UK)

1) Colophony : Not available.
 2) Xylene : TWA: 441 STEL: 662 (mg/m³) [United Kingdom (UK)] [1997] SKIN
 3) Zinc oxide : TWA: 5 STEL: 10 (mg/m³) [United Kingdom (UK)] [1997]
 4) IRON(III)OXIDE : TWA: 10 (mg/m³) [United Kingdom (UK)] [1997]
 5) Ziram : Not available.
 6) Butanol : TWA: 154 STEL: 231 (mg/m³) [United Kingdom (UK)] [1997]
 7) Dicopper oxide : Not available.

Ingredient comments : When this product is sprayed use the following OEL's for particulates:
 Respirable particulates 5 mg/m³.
 Total inhalable particulates 10 mg/m³.

All personal protective equipment, including respiratory protective equipment, used to control exposure to hazardous substances must be selected to meet the requirements of the COSHH regulations.

Respiratory system : Provide adequate ventilation. Use appropriate respiratory protection if there is the potential to exceed the exposure limit(s). Vapor respirator or a self-contained breathing apparatus. Be sure to use an approved/certified respirator or equivalent.

Skin and Body : Overalls buttoned to the neck and wrist. Remove contaminated clothing and shoes. Wash contaminated skin with soap and water.

Hands : Protective gloves and protective skin cream. After handling, always wash hands thoroughly with soap and water.

Page: 2/5

ABC # 3 ANTIFOULING RED

Eyes : Splash goggles.

9 Physical and Chemical Properties

Physical state : Liquid.
 Color : Product name
 Boiling Point : 99.5°C (211.1°F)
 Density : 1.812 g/cm3 at 25°C (77°F)
 Vapor Density : 2.6 (Air = 1)
 Vapor Pressure : 10.7 kPa (@ 20°C)
 Evaporation rate (butyl acetate = 1) : The highest known value is 0.77 (Xylene) Weighted average: 0.7 compared to (n-BUTYL ACETATE=1)
 Flash point : CLOSED CUP: 25°C (77°F). (Setflash.)
 Autoignition temperature : 390°C (734°F)
 Explosion Limits : LOWER: 1% UPPER: 9.8%

10 Stability and Reactivity

Stability : The product is stable.
 Conditions to avoid : Do not store below 5°C or above 40°C.
 Materials to avoid : This product should be stored away from oxidizing materials and strong bases/acids.
 Hazardous Decomposition Products : Decomposition products thermal decomposition may release hazardous gases. These products are carbon oxides (CO, CO2) nitrogen oxides (NO, NO2...) sulfur oxides (SO2, SO3...) Some metallic oxides.

11 Toxicological Information

Local effects

Skin irritation : Hazardous in case of skin contact (irritant).
 Eye irritation : Very hazardous in case of eye contact (irritant).
 Sensitization : Hazardous in case of skin contact (sensitizer).
 Acute toxicity : Acute oral toxicity (LD50): 470 mg/kg (rat). (Diacopper oxide).
 Acute dermal toxicity (LD50): >1700 mg/kg (rabbit). (Xylene).
 Chronic toxicity : Repeated exposure to a highly toxic material may produce general deterioration of health by an accumulation in one or many human organs.

Specific effects

Carcinogenic effects : Classified A4 (Not classifiable for human or animal.) by ACGIH, 3 (Not classifiable for human.) by IARC (Xylene). Classified A4 (Not classifiable for human or animal.) by ACGIH, 3 (Not classifiable for human.) by IARC [IRON(III)OXIDE]. Classified 3 (Not classifiable for human.) by IARC (Ziram).
 Mutagenic effects : Classified 3(a) by European Union (Ziram).

12 Ecological Information

Ecotoxicity : Not available. Prevent entry into sewers, basins/ditches or confined areas; clean if needed.

13 Disposal considerations

Methods of disposal; Waste of residues; Contaminated packaging : Dispose of this material and its container at hazardous or special waste collection points. Waste must be disposed of in accordance with local environmental control regulations.

ABC # 3 ANTIFOULING RED

14 Transport Information

General : Transport classification notes:
 Labelling and packaging requirements may vary with pack and load size. Please refer to the current transport regulations.

Transport within user's premises always transport in closed containers that are upright and secure. Ensure that persons transporting the product know what to do in the event of accident or spillage.

Land - Road/Railway

Marginal : 2301E
 UN number : 1263
 Proper shipping name : Paint.
 ADR/RID Class : 3
 ADR/RID Item number : Note to Section E
 Hazchem UK : 3Y
 Hazard Identification Number : 30
 Road Transport Notes : Category 3

Sea

UN number : 1263
 Proper shipping name : Paint.
 IMDG Class : 3.3
 Packing Group : III
 IMDG Page Number : 3372
 Medical First Aid Guide (MFAG) : 310
 Emergency Schedules (EmS) : 3-05
 Marine Pollutant : Not pollutant.

Air

UN/ID Number : 1263
 Proper shipping name : Paint.
 IATA-DGR Class : 3
 Packing Group : III
 Packaging Instruction : 309 and 310

15 Regulatory Information

EU Regulations

Hazard symbol(s) :



Classification : Harmful

Risk Phrases : R10- Flammable.
 R22- Harmful if swallowed.
 R38- Irritating to skin.
 R40- Possible risks of irreversible effects.
 R41- Risk of serious damage to eyes.
 R43- May cause sensitization by skin contact.

Safety Phrases : S23- Do not breathe gas/fumes/vapour/spray [***]
 S24- Avoid contact with skin.
 S28- In case of contact with eyes, rinse immediately with plenty of water and seek medical advice.
 S36/37/39- Wear suitable protective clothing, gloves and eye/face protection.
 S38- In case of insufficient ventilation, wear suitable respiratory equipment.
 S48- If swallowed, seek medical advice immediately and show this container or label.
 S51- Use only in well-ventilated areas.

ABC # 3 ANTIFOULING RED

Contains : - Colophony - Ziram - Dicooper oxide

United Kingdom

UK Regulatory references : This product is classified and labelled for supply in accordance with the Chemicals (Hazard Information and Packaging for Supply) Regulations 1993 and subsequent amendments (Directive 88/379/EEC).
The safety data sheet does not constitute the users own assessment of the workplace risk as required by other health and safety legislation e.g. the Control of Substances Hazardous to Health (COSHH) Regulations.
The Manual Handling operations Regulations may apply to the handling of containers/packages of this product. To assist employers, the following method of calculating the weight for any pack size is given. Take the size volume in litres and multiply this figure by the density value given in section 9. This will give the net weight of the coating in kilograms. Allowance will then have to be made for the immediate packaging to give an approximate gross weight.

16 Other Information

Date of printing : 04-08-2000.

Date of issue : 01-03-2000.

Date of Previous Issue : No Previous Validation.

Version : 1

Other information : EH 40 Occupational Exposure Limits.
HS(G)53 Respiratory protective equipment: a practical guide to users.
EH 9 Spraying of highly flammable liquids.
HS(G)22 Electrical apparatus for use in potentially explosive atmospheres.
HS(G)51 Storage of flammable liquids in containers.

Notice to Reader

To the best of our knowledge, the information contained herein is accurate. However, neither the above named supplier nor any of its subsidiaries assumes any liability whatsoever for the accuracy or completeness of the information contained herein.
Final determination of suitability of any material is the sole responsibility of the user. All materials may present unknown hazards and should be used with caution. Although certain hazards are described herein, we cannot guarantee that these are the only hazards that exist.

Page: 5/5

SAFETY DATA SHEET

Conforms to 93/112/EEC



1. IDENTIFICATION OF THE SUBSTANCE/PREPARATION AND OF THE COMPANY

PRODUCT NAME:

Cosmolubric TR 2000E

APPLICATION:

Vegetable oil based, high performance Hydraulic fluid.

NAME OF MANUFACTURER/SUPPLIER:

Houghton plc

ADDRESS:

Beacon Road
Ashburton Road West
Trafford Park
Manchester M17 1AF

TELEPHONE/FAX NUMBERS:

Business telephone no.: 0161-874 5000 Fax: 0161-877 9764

Health and Safety emergency telephone no.: 0161 877 6654 (out of hours only)

2. COMPOSITION/INFORMATION ON INGREDIENTS.

General: Performance additive. Vegetable oil. Emulsifiers.

Hazardous: %

Amine based compound (C, Xn), C34, R22 14

3. HAZARDS IDENTIFICATION.

This product is not classified as hazardous under current UK legislation.

4. FIRST AID MEASURES.

Eyes: Wash immediately with copious quantities of water. If irritation persists, seek medical attention

Skin: Wash with soap and water

Inhalation: Remove to fresh air.

Ingestion: Do not induce vomiting. Consult a physician. Product is mainly vegetable oil.

Pressure injection: OBTAIN IMMEDIATE MEDICAL ATTENTION EVEN IF THE INJURY APPEARS MINOR.

5. FIRE-FIGHTING MEASURES.

Suitable extinguishing media: Carbon dioxide, foam or dry chemical.

Not to be used: None anticipated - treat as oil fire.

Special exposure hazards: None.

Products of Combustion: Oxides of carbon and sulphur anticipated.

Special protective equipment: Self-contained breathing apparatus should be worn in fire conditions.

6. ACCIDENTAL RELEASE MEASURES.

Personal precautions: Wear suitable protective clothing.

Environmental precautions: Although the material is largely biodegradable, unnecessary discharge to the sea, sewers or open waters should be avoided.

Methods for cleaning up: No spillage hazard anticipated. Contain spillages and absorb on inert material.

7. HANDLING AND STORAGE.

Handling precautions: Avoid contact with skin and eyes. Avoid strong oxidising agents

Storage precautions: Good indoor storage conditions. Avoid strong oxidising agents.

8. EXPOSURE CONTROLS/PERSONAL PROTECTION.

Occupational exposure limits: Not applicable.

Eyes: Goggles are recommended where the material may be splashed

Skin: Gloves or suitable pre-work creams are recommended if prolonged or repeated contact with the fluid occurs.

Inhalation:

Industrial Hygiene: Good standards of industrial hygiene are recommended for use of this product

9. PHYSICAL AND CHEMICAL PROPERTIES.

Physical Form: Liquid **Appearance:** Clear, straw

Odour: Characteristic. **Specific Gravity (@15.5°C):** 0.95.

Pour Point (°C): **Boiling Point (°C):**

pH - concentrate: 9.65 **pH - working strength:**

Vapour Pressure (kPa): <0.01 (mm Hg) **Vapour Density (air=1):**

Miscibility with water: Forms an emulsion. **Evaporation Rate (nBuAc=1):**

Viscosity cS.: 46-49 @ 40°C. **Autoflammability, °C:**

Flash Point (°C, Open Cup): >150

Explosive properties %:

The data given here is typical for this material. It does not constitute a specification.

10. STABILITY AND REACTIVITY.

Chemical stability: The product is stable and not subject to polymerisation

Conditions to avoid: None.

Materials to avoid: Avoid strong oxidising agents

Hazardous decomposition products: Oxides of carbon and sulphur.

11. TOXICOLOGICAL INFORMATION.

The following toxicological assessment is based on a knowledge of the toxicity of the product's components.

Health Effects:

Eyes: Could be mildly irritating to eyes.

Skin: May cause degreasing of the skin leading to irritation.

Inhalation:

Ingestion: Ingestion of large quantities may cause nausea and sickness

Chronic: Unknown for this product.

Special hazards of product after use:

Pressure injection: Injection of all products will cause severe internal damage if not promptly treated.

12. ECOLOGICAL INFORMATION.

Mobility: Forms an emulsion with water.

Persistence and degradability: Degradable

Bioaccumulative potential: This material is unlikely to bioaccumulate.

Ecotoxicity: Rated as WGK 1 for water toxicity.

13. DISPOSAL CONSIDERATIONS.

Disposal must be in accordance with local and national legislation.

Unused material: The product should be removed by approved waste contractors

Used material: The used product should be removed by approved waste contractors

Empty packaging: 205 litre unlined steel drums may be returned for recycling. All other packaging should be disposed of in a manner acceptable to the authorities.

14. TRANSPORT INFORMATION.

Classification for transport: Not classified.

UN number: **Packing group:**

IMO Class:

ICAO/IATA Class:

ADR/RID Class:

Marine pollutant:

15. REGULATORY INFORMATION.

Classification for Supply: Not classified.

Risk phrases:

Safety phrases:

Note:

Statutory Instruments: The Health and Safety at Work etc. Act 1974.
Control of Substances Hazardous to Health Regulations 1988.
Environmental Protection Act 1990.
Chemicals(Hazard Information and Packaging)Regulations 1996.(As amended).

PRODUCT NAME: Cosmolubric TR 2000E

16. OTHER INFORMATION.

Note: where this product is used in applications other than those specified either here or in writing from Houghton plc we can accept no responsibility for loss or damage incurred.

Where applicable, concentration control methods are available on request.

Detailed formulations are available to medical officers and their advisors in confidence only on written request.

If the Issue No. is a Revision, then the important changes to the SDS are highlighted by "++++".

The following references provide further information on specific aspects:

EH 62 - Metalworking Fluids - Health Precautions.

IND(G)168(L)-Management of metalworking fluids.

The above publications are available from HSE.

SDS preparation date:

Appendix H

Wave Energy Technology (WET) Marine Corps Base Hawaii
Marine Environmental Assessment. May 2002.
Marine Research Consultants.

**WAVE ENERGY TECHNOLOGY (WET)
MARINE CORPS BASE HAWAII KANEHOE BAY
MARINE ENVIRONMENTAL ASSESSMENT**

DRAFT

Prepared for:
Belt Collins Hawaii
2153 North King St., Suite 200
Honolulu HI 96819

Prepared by:
Marine Research Consultants
4467 Sierra Dr.
Honolulu, HI 96816

May 20, 2002

Executive Summary

In April 2002, a Rapid Ecological Assessments (REA) of the marine environment from the shoreline to a water depth of 100 feet (30.5 meters) was conducted off of North Beach at Marine Corps Base Hawaii (MCBH) Kaneohe Bay. The area surveyed has been designated as the potential sites for the power transmission cable route, anchoring of six Wave Energy Conversion (WEC) buoys that comprise the Wave Energy Technology Project (WET), and placement of four mooring clumps for stabilizing work boats during installation and inspection of the WEC buoys.

The underwater environment can be divided into six distinct zones, each with unique physical structure and biotic composition. The transmission cable will enter the ocean in the wave impact zone off the beach adjacent to the northern end of the MCBH Kaneohe Bay runway. The cable will traverse the nearshore area through a region of shifting sand interspersed with boulders. Biotic composition in the area is essentially nil owing to continual scouring by sand. At approximately the 18-foot (5.5-meter) depth, fragments of fossil limestone reef form sand channels along the bottom. The selected cable route traverses sand channels to the greatest extent possible in order to minimize interactions with biota and to maximize engineering considerations for anchoring the cable.

At a depth of about 25 feet (7.6 meters) the sand channels grade into a flat, gently sloping reef platform covered with an algal turf and scattered coral colonies. At the 60-foot (18.3-meter) depth, the slope of the reef platform increases sharply forming an escarpment that extends to a depth of 70 feet (21.3 meters). At the base of the escarpment the bottom continues in a gentle slope to the proposed depth of the buoy field (90 to 100 feet [27.4 to 30.5 meters]). Flat encrustations of reef coral, primarily of the single species *Montipora capitata*, are common through the escarpment and deep reef platform zone to a depth of about 90 feet (27.4 meters). Beyond this depth coral cover decreases substantially, with bottom composition consisting primarily of a sediment covered limestone veneer. At the eastern end of the buoy field, several series of low undercut notches were observed. Abundance of fish and coral in the notches was substantially higher than on the surrounding reef flats. By locating the deployment site to the most northwestern part of the buoy field, the ledges will not be affected by the buoy and anchor system.

Environmental impacts from the proposed project should be insignificant. The Western Pacific Regional Fishery Management Council has designated all the ocean waters surrounding Ohau, from the shore to depths of over 100 feet as Essential Fish Habitat (EFH), for one or more species under their jurisdiction. However, none of the EFH or marine habitats within the proposed project area have been designated as Habitat of Particular Concern (HAPC). Observations of an old amphibious vehicle track on the reef platform reveals that coral colonization is higher on the artificial metal surface than the surrounding natural substratum. Similar recolonization of the armored transmission cable is likely to result in a net increase of living marine resources. Similarly, the buoy array is likely to serve as an attractant to fish in the manner of a fish aggregation device.

While designed to be able to withstand all potential wave forces, should the buoys be cast adrift, the point of breakage will likely leave the anchoring array in place. Should wave forces be sufficient to move the anchoring array, the intensity of the event will be so severe that the

damage caused by movement of the anchors along the relatively barren bottom will be insignificant compared to other damage in inshore areas. It is also planned to deploy a permanent four-point mooring system consisting of four 7,000-pound concrete clumps attached by taut chains to grouted rock bolts. The design of the mooring system is based on preventing movement of the concrete clumps and chains, thereby greatly limiting potential damage to the ocean floor compared with setting and retrieving anchors during each bi-monthly inspection of the WET system. Marking of the preferred sites for the mooring clumps by qualified diver-biologists should eliminate any negative impacts from the anchoring array.

Federally protected species of turtles and whales frequent the area. There is little potential for entanglement or other direct impacts from the structures. Conditions that will likely be contained in the permits for the project will stipulate mitigation actions that will be in place to avoid impacts to federally protected species during the actual deployment of the cable and buoys.

The proposed project does not appear to provide a mechanism for the introduction of alien species beyond the area of Kaneohe Bay where they presently occur. In addition, the project offers little or no potential for triggering algal blooms. In summary, the site for the proposed WET project is well suited for the project, with the potential for little if any negative impacts to the marine environment. As the proposed project is a test case, it is recommended that a monitoring program be implemented to document the actual affects of the project in terms of impacts (positive and negative) to marine biota.

1 PURPOSE

The Office of Naval Research (ONR) proposes the phased installation of up to six Wave Energy Conversion (WEC) buoys in approximately 95 to 100 feet (29 to 30.5 meters) of water off North Beach at Marine Corps Base Hawaii (MCBH) Kaneohe Bay (Figure 1). The purpose of the test is to gather operational data to validate the technology of the WEC buoy developed by Ocean Power Technologies Inc. (OPT).

Each WEC buoy is comprised of a cylinder, buoyancy tank, and a central rigid spar buoy. The cylindrical steel buoys are approximately 15 feet (4.6 meters) in diameter, and 39 feet (11.9 meters) long. They operate 3 to 13 feet (0.9 to 4.0 meters) below the ocean surface. The rigid spar buoy is connected to the anchoring system with a universal joint. The total buoy anchor weight would be 35 to 70 tons (32 to 64 metric tons). The anchor base would be ringed by a flange frame which will be rock bolted to the sea floor. In addition to the moored WEC buoys, four "mooring clumps" will be placed on the bottom to provide for stable mooring of work boats that will be required for installation and periodic inspection of the wave buoys.

Wave motion moves the power buoy up and down the rigid spar buoy. A power conversion system in the buoy converts the motion into rotary power that spins a generator located in the equipment canister on the ocean floor. Power from the generator is carried to shore through an armored and shielded undersea cable on the ocean floor. The undersea cable is connected to a land transmission cable in a concrete utility vault located above the high water mark. From the utility vault, the power will be carried through a land transmission cable to a shore base facility where it will be converted into power that can be distributed to the MCBH Kaneohe Bay electrical power grid. Following the 5-year testing phase, it is planned that the buoys and transmission cables will be removed from the test site.

The test site is located on the sea floor approximately 4,000 feet (1,219 meters) northeast of the end of the main runway at MCBH Kaneohe Bay in approximately 100 feet (30.5 meters) of water. The site offers a combination of favorable ocean wave climate, ocean floor topography, restricted public access, and onshore utility infrastructure needed for conducting the WEC system test. At present, the "buoy field" consists of a parallelogram shaped area bounded by the 92-foot (28.0-meter) and 104-foot (31.7-meter) depth contours. Three buoys are aligned on each of two lines that form the long sides of the parallelogram. The power transmission cable will extend from the buoys across the seafloor to the intertidal area where it exits the ocean across the beach.

Part of the planning documentation required for the project is descriptions of existing environmental conditions, potential environmental impacts, and suggested mitigation measures to minimize or avoid potential impacts. The purpose of this report is to provide such a characterization of the marine environment that occurs in the area of buoy deployment and along the route of the power transmission cable.

2 SURVEY TEAM

Underwater surveys were conducted on April 10 and 12, 2002 by Dr. Steven Dollar (author of this report). On April 10, 2002, other field investigators included Robert Rocheleau and Mark Ericksen of Sea Engineering, Inc., John Naughton and Alan Everson of the National Marine Fisheries Service (NMFS), and Antonio Bentivoglio of the U.S. Fish and Wildlife Service (USFWS). Mr.'s. Naughton, Everson and Bentivoglio also were present for the fieldwork on April 12, 2002.

3 FIELD SURVEY PROCEDURES

Field surveys employed a method referred to in the scientific literature as "Rapid Ecological Assessment" (REA). This method consists of swimming through the entire area of concern, noting major components of physical structure of the habitat, as well semi-quantitative evaluation of major biotic components. Such a method allows for comparative evaluations between areas, and is very efficient with respect to habitat characterization and time spent in the field. Photographic records of community composition and physical structure provide a permanent record of the marine habitats. In this manner, the entire length of the buoy field, and the entire length of the transmission cable route were surveyed.

4 RESULTS

4.1 Zonation Pattern of the Marine Environment

Figure 2 shows a schematic zonation diagram of the marine habitat off of North Beach that extends from the shoreline where the cable will enter the water across the reef face to the area where the WEC buoys will be deployed. Along this route six distinct habitat types exist, each characterized by a depth range, substratum type, and biotic composition. Each of these zones is discussed below.

4.1.1 Sand-Boulder Zone

The power transmission cable crosses the beach and enters the ocean in the sand-boulder zone. The nearshore area in this zone, which extends from a depth of zero to approximately 12 feet (3.7 meters), consists of a bed of coarse-grained carbonate sand that is kept in a state of continual resuspension by wave energy. During the present survey, when breaking waves on the shoreline were about as small as ever occurs, sand in the nearshore zone was still resuspended with each passing swell (Figure 3). Interspersed on the sand bed are boulders that are continually swept by resuspended sand. As a result, there is little or no macrobiota colonizing the boulders (Figure 3). Some of boulder riprap that was used to construct the rampart securing the end of the runway has separated from the structure and is submerged in the nearshore area.

4.1.2 Sand Channel Zone

At an approximate depth of about 18 feet (5.5 meters), and a distance of several hundred feet from shore, the nearshore sand bed is intersected by exposed segments of fossilized limestone reef platforms (Figure 4). The emergent limestone reef remnants are not continuous in this area and create a series of sand channels, bordered by vertical faces of the reef platforms. There is little consistent orientation of the channels, as there are in typical spur-and-groove reef fronts. In general the sand channels lie along the inshore-offshore direction.

As with the inshore sand-boulder zone, the sand in the channels is in a constant state of resuspension, which restricts settlement of biota on both the sand and limestone reef surfaces. Major biota observed were scattered heads of the branching coral *Pocillopora meandrina*, growing on the vertical sides of the reef channels. One of the goals of selecting the exact route of the transmission cable was to run the cable through as many of the sand channels as possible to both minimize contact with biota and to simplify the cable attachment procedure.

4.1.3 Reef Flat Zone

Moving offshore from the sand channel zone, the emergent fossil reef platform becomes progressively more solid as sand cover decreases. At approximately the 30-foot (9.1-meter) depth bottom composition is a solid limestone reef flat (Figure 5). The surface of the reef flat consists of a short algal turf that binds a thin layer of carbonate sediment. Macrobiota on the flat platform include sporadic heads of the coral *Pocillopora meandrina* and flat encrustations of *Porites lobata* and *Montipora capitata*, *M. patula*, and *M. flabellata*. The dominant algae on the platform are clumps of the red calcareous genera *Porolithon* (Figure 6).

Interspersed on the reef flat platform are small ledges and depressions. Coral growth at the edges of the ledges is higher than on the surrounding flat areas (Figure 5). Similarly the occurrence of fish is greater under the ledges than on the flats. Another very infrequent occurrence on the reef platform was large colonies of the branching coral *Pocillopora eydouxi* (Figure 6). These large colonies, up to 2 feet (0.6 meters) in height, are able to stand the rigors of wave stress on the deeper regions of the reef platform. Schools of the damselfish *Dascyllus albisella* were resident on both of the large coral heads observed.

Another interesting observation on the reef flat was the occurrence of an old track from a tank or amphibious vehicle (Figure 7). The track, which is about 50 feet (15.2 meters) long, was nearly totally covered with mature heads of the coral *Pocillopora meandrina*. In comparison, the surrounding reef platform was practically devoid of similar coral growth (Figure 7). This observation makes two important points. First, it is apparent that benthic biota will grow (in this case preferentially) on man-made objects on the bottom. If the tank track can be viewed as a proxy of the power generation cable and attachment casing, then the cable may result in a net increase in coral on the reef platform compared to present conditions. Second, it can be seen the metal tank track does not result in the growth of any biota on the surrounding reef that could be construed as a negative feature, such as blue-green algae.

4.1.4 Escarpment Zone

The reef platform slopes gradually to a depth of 60 to 65 feet (18.3 to 20 meters) where the angle of the bottom increases sharply to 25 to 30 degrees. As is typical on all of the Hawaiian Islands, there is a wave-cut notch at the 60-foot (18.3-meter) depth, which was cut at a lower stand of sea level. In some areas the wave-cut notch forms undercut ledges which are generally areas of higher biotic diversity than the neighboring flats. In addition, the undercut notches often serve as resting habitat for green turtles. For instance, at some areas of Oah'u (Barbers Point is an example) the 60-foot (18.3-meter) ledge consists of an undercut notch that serves as preferred habitats for fish and turtles. These areas have been considered Habitat Areas of Particular Concern (HAPC) by regulatory agencies. The technical definition of HAPCs, as defined by the Magnuson-Stevens Fishery Conservation and Management Act, is...“HAPCs are a subset of Essential Fish Habitats which are habitat areas that are “rare, particularly susceptible to human-induced degradation, especially ecologically important, or located in an environmentally stressed area.” At the WET site, however, the old shoreline consists only of an increase in the slope of the bottom between the depths of about 60 to 70 feet (18.3 to 21.3 meters). None of the area of the 60-foot (18.3-meter) ledge off MCBH Kaneohe Bay that was observed is considered as HAPC.

The primary macrobiota on the escarpment was the flat encrusting coral *Montipora capitata*. In some localized areas, bottom cover of the flat encrusting coral comprised up to 50 percent of the bottom (Figure 7). These flat encrustations extended into deeper water from the reef escarpment down to the deep reef platform.

4.1.5 Deep Reef Platform Zone

From the bottom of the escarpment, the bottom slopes gradually to the depth limit of the present survey (approximately 100 feet [30.5 meters]). Bottom composition in the deep reef zone is very homogeneous, consisting of a flat, pitted limestone surface covered with a veneer of algal turf binding a thin layer of sediment. The dominant macrobiota on the reef platform are scattered heads of *Pocillopora meandrina*, and flat encrustations of the single species *Montipora capitata* (Figure 8). In some areas cover of *M. capitata* was substantial, comprising up to 25 percent of bottom cover. As a result of the relatively high cover of this coral, and the lack of other encrusting species, it appears that *M. capitata* has adapted to be able to withstand the sediment scour that occurs on the flat reef platform.

While bottom topography remains relatively constant through the depth range of the survey, there is a fairly distinct boundary in biotic composition at a depth of about 95 feet (29.0 meters). As described above, down to this depth range, coral cover was relatively high, primarily as a result of cover of flat colonies of *M. capitata*. Below the depth of 95 feet (29.0 meters), coral cover dropped considerably, and the bottom consisted mostly of limestone veneer and a thin layer of sediment (Figure 9). Comparing photographs in Figure 8 at a depth of 90 feet (27.4 meters), and Figure 9 at a depth of 100 feet (30.5 meters) illustrates the considerable difference in coral cover within a relatively small depth range. The flat, barren reef platform at the 95- to 100-foot (29.0- to 30.5-meter) depth range represents an ideal location for deployment of the WEC buoys.

4.1.6 Undercut Ledge Zone

One noteworthy feature was observed in the deep reef platform. At several locations at the eastern end of the buoy field, a system of small undercut ledges ran parallel to depth contours (Figure 10). One ledge, approximately 25 feet (7.6 meters) in length was observed at the 93-foot (28.3-meter) depth, and a larger system approximately 150 feet (45.7 meters) in length was observed at the 100-foot (30.5-meter) depth contour (Figure 10). These ledges were approximately 1 to 2 feet (0.3 to 0.6 meters) in height, with the undercuts extending about 1 to 3 feet (0.3 to 0.9 meters) under the lip of the ledge.

The most conspicuous feature of the ledges was the increased populations of fish and coral compared to the surrounding flat reef platform. Relatively large aggregations of several species of reef fish, including the blue-lined snapper *Lutjanus kasmira* (ta'ape), and the squirrelfish *Sargocentron diadema*, *S. ensiferum*, and *Myripristis bernardi* (mempachi) were the most common (Figure 10). Other fish that were resident in the notches were goatfish (*Parupeneus* spp.) and several species of cheatodonts (*Chaetodon miliaris*, *C. multivittatus*) and surgeonfish (*Zebrosoma flavescens*) (yellow tang). One uku (*Aprion virescens*) was observed in the distance over the ledges. The dominant coral was the encrusting form of *Montipora capitata*, which covered large areas of the upper lips of the undercut ledges (Figure 10). Several species of sea urchins (*Echinometra matheai*, *Colobocentrotus* sp., *Echinothrix diadema*, and *Heterocentrotus mammillatus*) were observed in the ledge area.

As discussed above, undercut ledges can be designated as essential fish habitat or HAPC. Based on the relatively small size of the ledges observed on the deep reef platform of off MCBH Kaneohe Bay, these ledges would not fall under this classification of HAPC according to the opinion of National Marine Fisheries biologists that made up part of the field survey team. Based on the observation of the ledges, however, the location of the WEC buoy field has been shifted to the northwest to avoid the area where the ledges occur.

5 DISCUSSION AND CONCLUSIONS

5.1 5.1 Deployment Site and Undersea Cable Route

The deployment site² and nearshore cable route consist of a sand beach and sand plains in the high-energy surf zone of a wave-exposed coastline. As a result of continual sand movement in this area, macrobiota are essentially absent. Beyond the nearshore sand plain, a series of sand channels created by interspersed eroded fossil reef platforms provide a preferred cable route that avoids interactions with biota, and provides a preferable substratum for cable attachment. Beyond the sand channels, the cable route traverses the solid surface of a relatively barren reef platform that extends over the 60-foot (18.3-meter) escarpment and down to the 100-foot (30.5-meter) depth of buoy deployment. While there are occasional areas of higher biotic diversity on the platform, these areas can be avoided during the cable laying procedure. It is anticipated that

² Deployment site refers to the shore-based landing site used for pulling the cable from the water to the utility vault located above the high water mark. Once secured at the utility vault, the cable would be pulled seaward.

the somewhat flexible nature of the transmission cable, and the methodology planned for deployment, should allow for placing the cable in the most favorable areas possible.

The transmission cable will be fixed to the bottom in a manner to prevent any movement that could result in scouring of the reef surface. While the exact method has not been determined, one potential method of attachment will include covering the cable with a split pipe, which is secured with bolts set into holes, drilled in the reef surface. Observations of a remnant track from a military vehicle that has apparently been on the reef surface for a number of years revealed substantially higher colonization of the track by corals than on the surrounding natural bottom. It is hypothesized that the increased colonization is a result of either elevated relief off the bottom, which lessens sand scour, or the metal surface of the track is a preferred settling substratum for corals. In any event, it is very clear that the artificial surface created by the metal track did not result in anything that could be considered a negative environmental effect such as triggering blooms of blue-green algae. The tank track provides a good proxy for the prospective effects of attaching the armored power transmission cable to the reef surface. As the cable and protective armor will also project above the level of the natural platform, it can be expected to enhance coral settlement in the area, resulting in a net increase in coral cover.

No areas observed within the cable deployment route were considered special habitats, specifically HAPC (see definition above). Nor were any species of particular commercial or recreational value observed. In fact, the only area of the cable route and buoy deployment site where any species of recreational fishing value were observed was the ledge zone at the 90 to 100-foot (27.4- to 30.5-meter) depth. As the shallower area is restricted from entry to fishermen, the depauperate nature of the fish communities is a result of less than favorable habitat, rather than fishing pressure.

5.2 Wave Buoy Array and Anchor Site

The deployment of up to six WEC buoys is projected to take place within a rectangular field bounded by the 94 to 104-foot (28.6- to 31.7-meter) depth contours. The present configuration of the buoy field consists of two parallel lines of three buoys equally spaced approximately 50-m (164 feet) apart. Site inspection of the buoy deployment area revealed that most of the region consists of a flat, gently sloping reef platform covered with an algal turf-bound layer of sediment. Below a depth of about 95 feet (29.0 meters), coral cover of the reef platform is very low. As a result, it has been recommended that the buoys be placed at a depth of 95 to 100 feet (29.0- to 30.5-meter). Several areas of small undercut ledges, with resident biota of higher abundance and diversity than the surrounding flats, occur toward the eastern end of the buoy field. Moving the buoy deployment sites to the northwest should avoid the ledges.

It is also planned to deploy a permanent (for the duration of the project) four-point mooring system. The mooring will consist of four 7,000 pound concrete clumps, each of which is attached to a 100-foot (30.5 m) length of anchor chain that are attached taut to grouted rock bold sunk into the substratum. The chain and rock bolts are safety measures to prevent the mooring from being dragged long distances across the bottom if extreme loads are applied to the mooring lines. Calculated maximum area of movement of the chain is about one foot in the unlikely event that the concrete block is moved. A small cylindrical surface float is attached to each of the mooring clumps which will serve both to mark the sites of the anchoring moorings and notify boaters of

the submerged WEC buoys. During installation and every other month after installation, an 80-foot boat will transit to the site and will attach mooring lines to each of the four floats. This configuration will provide stability for the vessel as a dive platform. In addition, the mooring will ensure that there is no contact with the WEC buoys during installation and maintenance. In addition to the stability provided by the four point permanent mooring, the mooring will cause substantially less impact to the ocean bottom than anchoring of the work boat during each minimum of 30 bi-monthly deployments over the five-year duration of the project.

As with the cable route, there are no HAPC or commercial and recreationally important species that will be affected by the WEC buoys or the four-point mooring buoy deployments.

5.3 Endangered and Protected Species

Several species that occur in Hawaiian waters are classified as endangered or protected under federal law. The protected green sea turtle (*Chelonia mydas*) occurs commonly throughout the Hawaiian Island chain, while the endangered Hawksbill turtle (*Eretmochelus imbricata*) is occasionally observed. While no turtles were observed during the field surveys at North Beach for the present survey, turtles undoubtedly traverse the area. However, none of the common algal assemblages noted in the survey area consisted of preferred forage species, and none of the physical structure of the reef surface could be classified as preferred resting habitat. While a system of ledges was noted at the 90 to 100 foot (27.4- to 30.5-meter) depth, the narrowness of the undercuts prevented the notches from affording turtles resting habitat. In areas where undercuts do serve as habitual resting habitat, turtles will abrade the upper surfaces of the cave with their shells producing a distinct smoothed surface. No such surfaces were observed at the WEC buoy sites.

The endangered humpback whale (*Megaptera novaeangliae*) occurs in Hawaiian waters during the winter months, generally from about October to early May. Several whales were observed breaching several hundred yards offshore of the buoy deployment site during the present survey. Personnel employed at MCBH Kaneohe Bay report the common occurrence of whales in nearshore waters throughout the season.

6 ENVIRONMENTAL CONSEQUENCES AND RECOMMENDATIONS

6.1 Deployment Site and Undersea Cable Route

Environmental consequences resulting from the installation of an undersea power transmission cable should be negligible. In fact, based on observations of other metal objects that have been on the bottom for a considerable length of time, it is likely that the armored cable will result in a net increase in abundance of macrobiota, particularly reef corals.

Deployment of the cable will involve unspooling the cable from a barge, followed by attachment to the bottom by bolts or other permanent fasteners. The route of the cable has been selected to minimize interactions with biota, and the overall environmental setting of the cable route is relatively depauperate of rich biotic communities. The selected route will utilize cracks and sand

channels to the greatest degree that is feasible. Most of these cracks and channels are presently filled with a layer of sand, precluding settlement of biota. Thus, the fixed cable will not have any minimal interaction with sessile organisms. In fact, as described above, the anchored cable will likely increase the available solid surfaces for settlement of benthic organisms similar to the amphibious vehicle track observed along the cable route. In addition, the fixed cable will traverse only a very minor area of ledge or overhang habitat, thus causing virtually no interference with fish habitat. As the cable has some degree of flexibility, it is recommended that divers on site bend the cable as needed to avoid any of the small sporadic topographical or biological rich areas that were observed along the cable route.

There are no aspects of the fixed cable that will cause any negative environmental effects to federally protected species. Nor will there be any potential for triggering of algal blooms or other negative shifts in biotic composition, particularly the introduction of alien species. Numerous metal objects (e.g., moorings, anchors, cables, buoys, artificial reefs constructed from derelict ships) presently occur in Hawaiian waters with no negative effects such as triggering of algal blooms. In addition, during the decades when introduced algal species have occurred in Kaneohe Bay, numerous boats have traversed the inner Bay to the open ocean near the project site without the spread of alien species. It is likely that the alien species that are presently considered a nuisance within the Bay are restricted to the particular oceanographic conditions and habitat characteristics that are unique to inner Kaneohe Bay. As the oceanographic climate at the wave-exposed project site is drastically different than the Inner Bay, it is likely that spread of the alien algal species is not possible.

Present plans call for the test project to proceed for five years. It is recommended that at the conclusion of the 5-year period, consultations with biologists from relevant government agencies and the private sector evaluate the best alternative for the cable. Should the cable be serving as an area of enhanced colonization of biota with no apparent negative effects, and the points of attachment appear to be structurally strong, leaving the cable in place may be the best alternative. If the anchors holding the cable appear to be weakening, which could result in loosening of the cable with subsequent scouring of the bottom, removing the cable may be the best alternative.

6.2 Wave Buoy Array and Anchor Site

The proposed deployment and mooring of the WEC buoys should result in minimal environmental consequences. As stated in the sections above, none of the marine habitats that will be affected by the project are considered HAPC or areas of special concern, nor will there be an effect to commercially or recreationally important species. During the course of the present survey, very few fish of potential recreational or commercial value were observed by investigators. These observations were made during a period when fishing is essentially restricted in the area, so that the abundance of fish can be viewed as the "natural" state. As with coral recruitment on the cable, it is likely that the structures of the buoy array and anchors would increase the abundance of fish of commercial and recreational value. The assortment of artificial reefs and fish aggregation devices around the state attest to this argument that increasing the structural complexity of the water column will increase fish abundance. With respect to the buoys, care has been taken to situate the buoy field to an area with minimal biotic composition, so direct impacts to the benthos from placing the buoys and anchors are minimal. The heavily ballasted anchor would be ringed with a flange frame and rock bolted to the seafloor. The weight

of the anchor base would prevent vertical movement of the base in design wave conditions and the rock bolts would prevent horizontal movement under design wave conditions. The anchor design would eliminate the potential for scour of the bottom. In fact, as validated by the observation of the high rate of colonization of a discarded amphibious vehicle track, the anchor array will likely result in an overall increase in biotic composition and abundance in the areas where the anchoring system is situated.

While engineering design should result in a system that can withstand all but the most intense levels of wave energy, considerations are given to the consequences of the buoy being set adrift. If the point of mechanical failure were above the gravity base, such as at the universal joint, it would be expected that the anchoring system would stay in place with no environmental consequences. As the buoy contains a buoyancy tank, upon separation the buoy would likely rise to the surface and be transported in the direction of prevailing current.

The anchor design should minimize or eliminate any movement of the anchor that could result in breakage of some of the corals and small ledges observed in the anchoring zone. There would be a relatively small amount of change caused by movement of the anchors over a short distance.

The work boat mooring configuration will consist of deploying four 7,000 concrete clumps connected by chains to grouted rock bolts. In addition to the stability that such a system offers to the work boat as a diving platform, the design also will likely result in far less damage than setting and retrieving anchors during WEC buoy installation and bi-monthly maintenance.

The proposed footprint of the four-point monitoring is outside of the boundary of the WEC buoy arrangement. Two of the mooring buoys will be in shallower water at about the 90-foot (27 m) depth, and two are proposed to be located at about the 106 foot (32.3 m) depth. Results of the surveys indicate that deployment of the deeper buoys will not present a problem with respect to impacting marine resources. The shallower buoys, however, could be deployed in the area of some of the ledges discussed above. It is recommended that prior to initial deployment of the mooring clumps, qualified diver-biologists place small marker buoys in appropriate areas for the mooring clumps in order to avoid any areas of particularly high biotic diversity. These marker buoys could then provide guidance for deploying the mooring clumps to the best locations possible.

With respect to the effect of the WEC system on marine life, all of the buoys are likely to serve as an attractant to fish, somewhat in the fashion of fish aggregating devices (FADS) that are intentionally deployed for the purpose of increasing fish catch. As the buoys will be painted with anti-fouling paint, there will likely be little colonization of the buoy surface with fouling organisms.

While the buoys may attract turtles and/or whales, there are no components of the design that could result in tangling. One potential consideration is to cover the open bottom of the buoy with a wire screen to prevent turtles from entering the buoy. Conversely, if turtles enter the open end of the buoy, there is no structure within the cylinder that could result in entanglement. Other offshore buoy systems, such as ship moorings, harbor entrance channel moorings, and oil refinery moorings presently in place off Oahu have not proven to be a hazard to turtles or whales.

One concern that will be likely be addressed in permits issued by federal agencies will be the mitigation protocols for the presence of protected species during the in-water work of laying the transmission cable and deploying buoys. Such mitigation will stipulate the conditions under which work will be ceased with protected species present, as well as conditions when work can resume.

As the buoys will not be deployed in waters in other locations prior to placement at the MCBH Kaneohe Bay site, there is no potential for the introduction of alien species.

Because the proposed project is considered a test, it is also recommended that a monitoring program is designed and implemented for the 5-year duration to evaluate and quantify the actual effects of the WEC system. Such a program should be initiated immediately prior to deploying the buoys and cable in order to acquire a quantitative baseline. Subsequent surveys at intervals during the operation of the system will provide data that can be used to determine actual effects to the marine environment that can be applied to other systems that may be planned in the future.

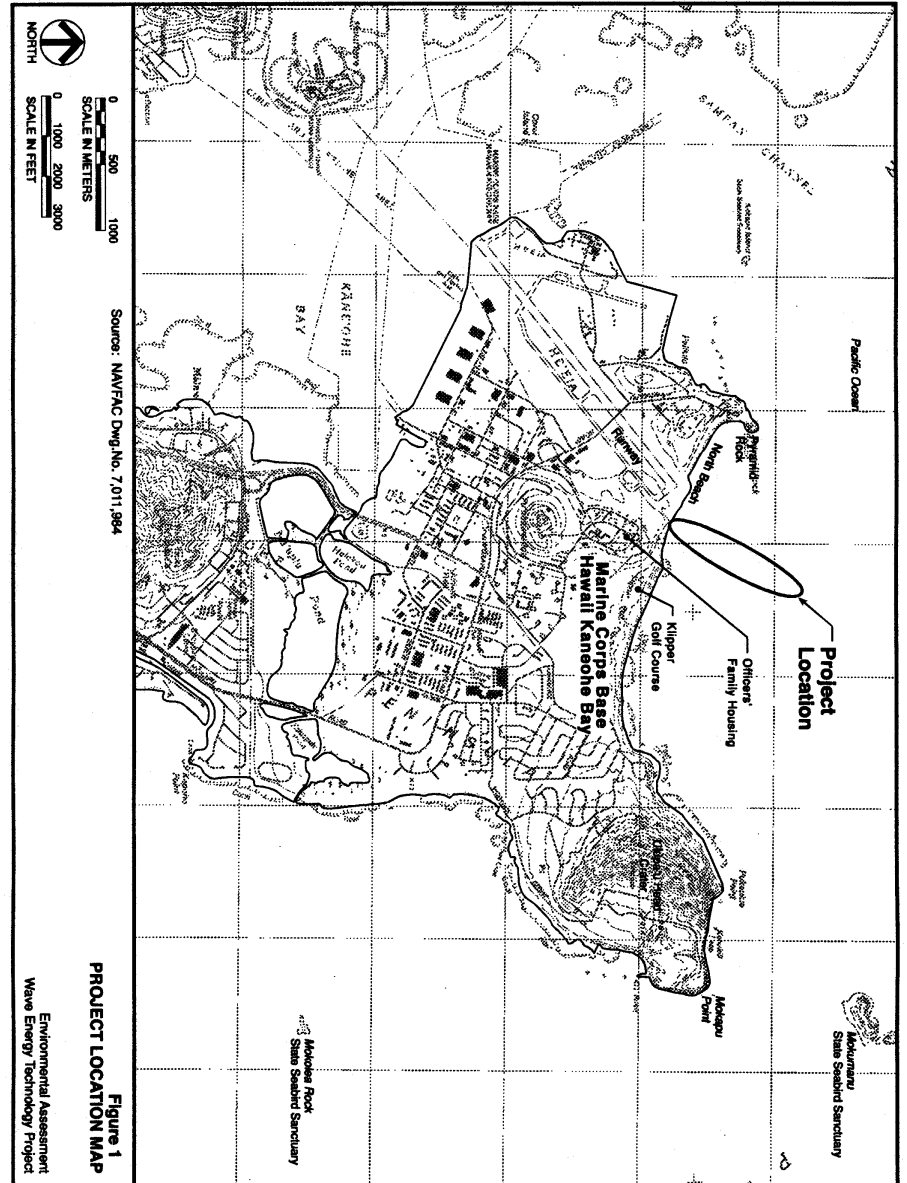

Figure 1
PROJECT LOCATION MAP
Environmental Assessment
Wave Energy Technology Project

WET BUOY/CABLE ROUTE BENTHIC ZONATION

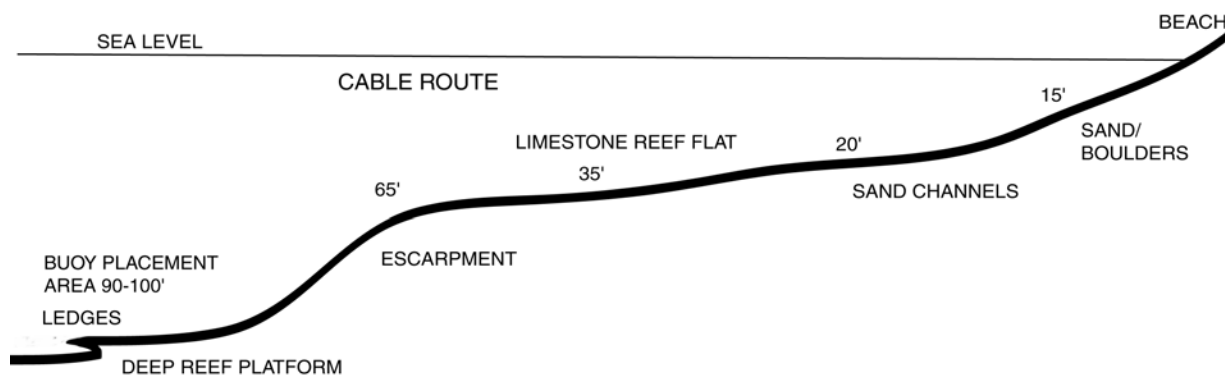

FIGURE 2. Schematic diagram of zonation of marine environment along route of Wave Energy Conversion (WEC) cable and buoy deployment area at North Beach, MCBH Kaneohe Bay. Figure is not to scale horizontally or vertically. Average depth of each zone is shown.



FIGURE 3. Photographs of bottom near shoreline entry point of WET cable off MCBH. Top photos show shifting sand bottom during lull in wave activity (left) and with sand in suspension from energy of passing wave (right). Bottom photos show bare limestone rocks interspersed on sand bottom. Water depth is 6-8 feet.



FIGURE 4. Photographs of bottom in sand channel zone offshore of entry point of WET cable off MCBH. Water depth is 20-25 feet.

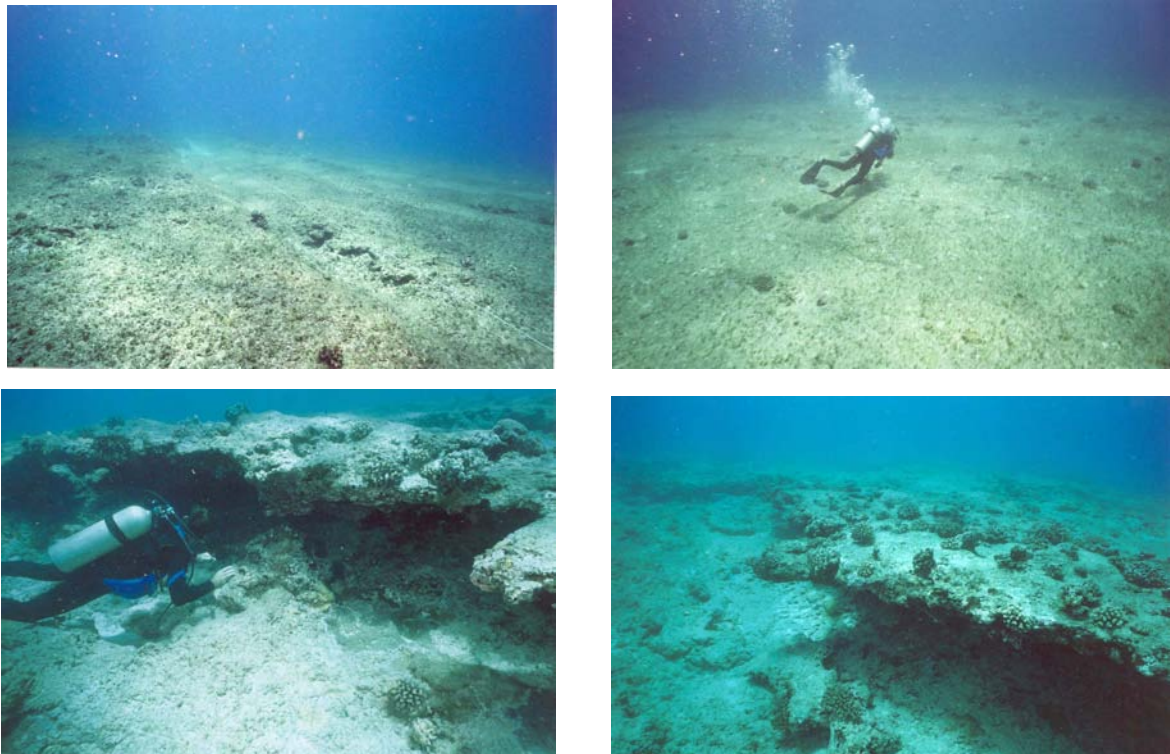

FIGURE 5. Photographs of bottom in reef flat zone along WET cable route off MCBH. Top photos show flat limestone pavement. Bottom photos show ledges that are interspersed on the pavement. Spherical coral colonies at edge of ledge are *Pocillopora meandrina*. Water depth is 30-35 feet.

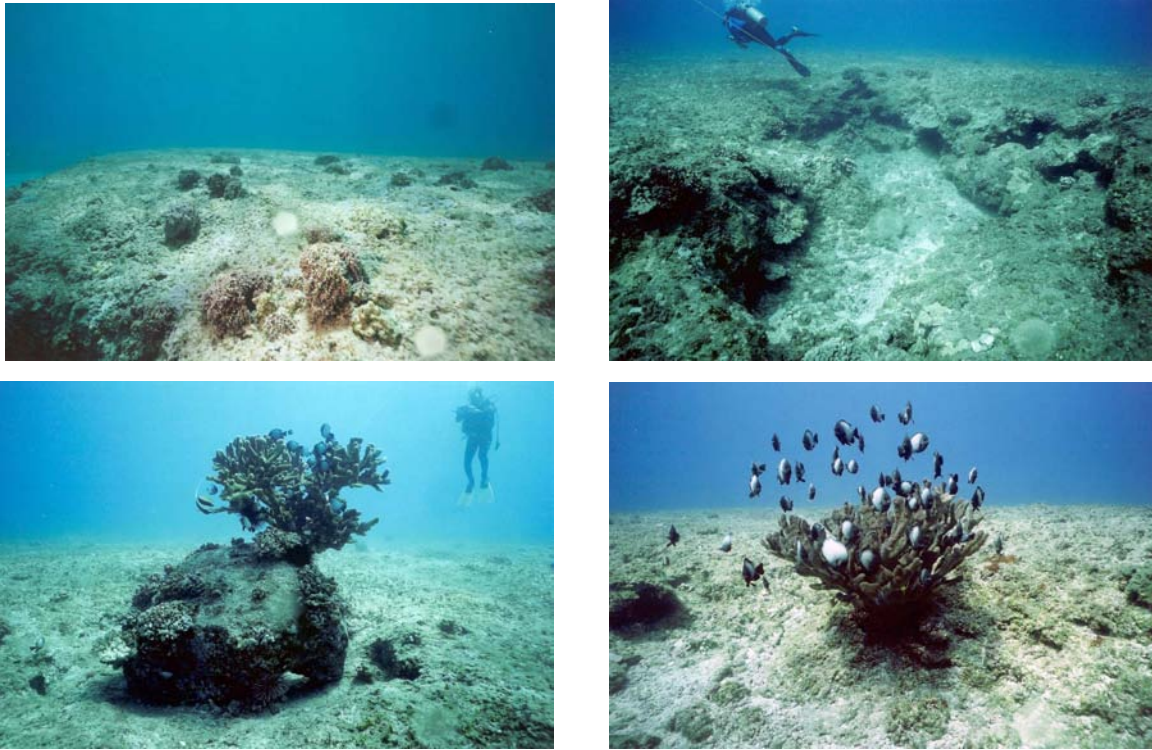

FIGURE 6. Photographs of reef platform in WET cable deployment area. Photo at upper left shows common coralline alga (*Porolithon* spp.) that occurs on reef platform. Photo at upper right shows sand and rubble filled depression in reef platform. Bottom photos show two large heads of the branching coral *Pocillopora eydouxi*, with aggregations of the damselfish *Dascyllus albisella* that typically occur in the vicinity of such large coral heads. Water depth is 30-35 feet.



FIGURE 7. Photographs of reef slope in WET cable deployment area. Upper photos and lower left show face of gentle sloping escarpment at Depth of 65 feet. Photo at lower right shows old tank track that is colonized with numerous large colonies of reef coral, primarily of the species *Pocillopora meandrina*. Density of coral on old track is substantially higher than on surrounding natural bottom. Water depth is 30-35 feet.

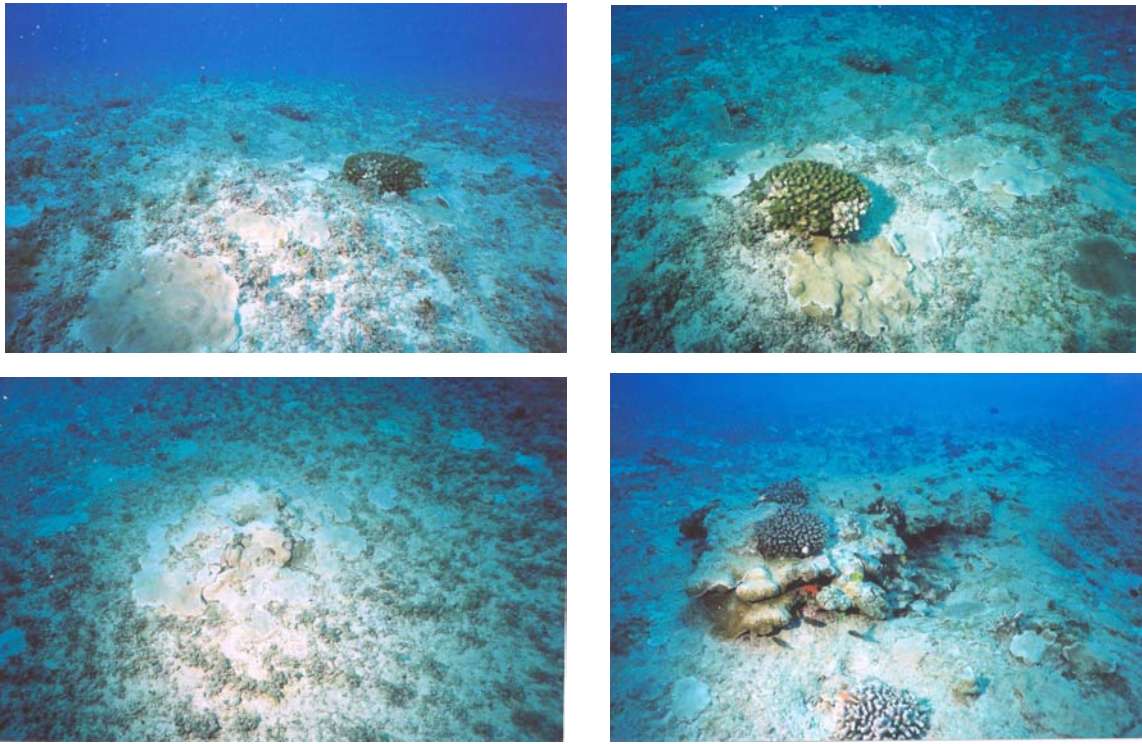

FIGURE 8. Photographs of bottom at 90-foot depth in WET buoy deployment area. Bottom cover consists of relatively large proportion of flat encrusting corals, predominantly of the species *Montipora capitata*. Hemispherical green-brown branching coral in three of the photos is *Pocillopora meandrina*.

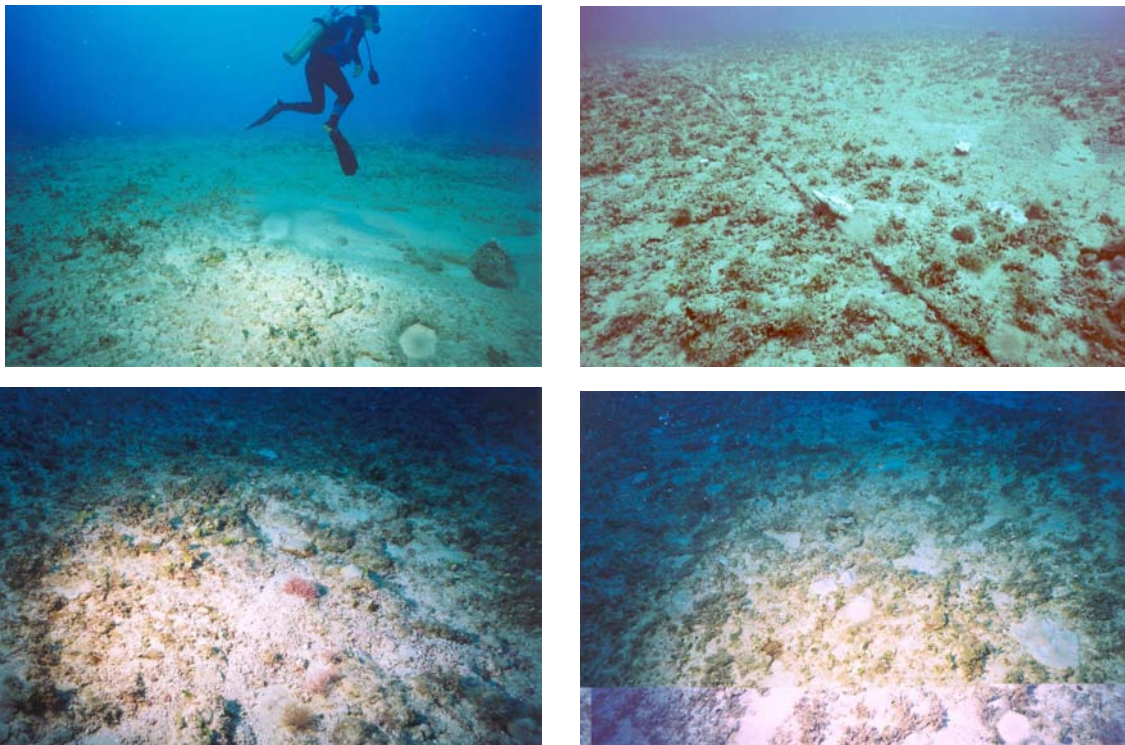

FIGURE 9. Photographs of ocean bottom at 100-foot depth in WET buoy deployment area. Bottom composition consists of flat limestone Platform with a thin layer of fine sand. Corals are not abundant.



FIGURE 10. Photographs of ledges at 100-foot depth in WET buoy deployment area. Abundant fish in photo at lower left are *Lutjanus kasmira*, *Sargocentron* spp., and *Myripristis berndti*.

Appendix I

Marine Public Safety and Recreational Uses Report for the
Wave Energy Technology (WET) Test Environmental
Assessment (EA). May 2002.
Ocean Recreation Consultant, John Clark.

Marine Public Safety and Recreational Uses Report
for the
Wave Energy Technology (WET) Test
Environmental Assessment (EA)

Prepared for

Belt Collins Hawaii Ltd
2153 North King Street, Suite 200
Honolulu, Hawaii 96819

Prepared by

John Clark, Ocean Recreation Consultant
P.O. Box 25277
Honolulu, Hawaii 96825

May 2002

1 MARINE PUBLIC SAFETY AND RECREATIONAL USES

1.1 Purpose

This marine public safety and recreational uses report was conducted to provide information for an environmental assessment (EA) for a Wave Energy Technology (WET) test at Marine Corps Base Hawaii (MCBH) Kaneohe Bay. In accordance with the National Environmental Policy Act of 1969 (NEPA), an EA is being prepared to identify existing environmental conditions and potential environmental impacts. The information in this report is intended to assist Belt Collins Hawaii Ltd., the EA contractor, in addressing public safety and recreational user concerns in regard to this project.

1.2 Project Description

The WET test would include the installation of six wave energy conversion (WEC) buoys off North Beach at MCBH Kaneohe Bay. The purpose of the test is to gather operational data to validate the technology of the WEC buoy developed by Ocean Power Technologies Inc. (OPT), in a realistic ocean setting for a period of five years.

The WEC buoy is fabricated of steel and comprised of a cylinder, a buoyancy tank, and a central rigid spar buoy. The buoyancy tank, attached to the top of the buoy cylinder, is the same diameter as the buoy cylinder and approximately 11 feet (3.4 meters) in length. It provides enough buoyancy to float itself and its attached cylinder. The buoy cylinder moves up and down the spar buoy creating motion that is converted to useable energy. The buoy cylinder is a hollow steel unit approximately 15 feet (4.5 meters) in diameter and 39 feet (12 meters) long. It is attached to the buoyancy tank, and is designed to float 3 to 13 feet (1 to 4 meters) below the surface. The spar buoy, constructed of steel, is positively buoyant. It is fixed to a gravity-base anchor, and keeps the system upright while it sways back and forth as the waves move by. A universal joint allows motion of the buoy on two axes.

Wave motion moves the power buoy up and down the rigid spar buoy. A power conversion system in the buoy converts the motion into rotary power that spins a generator located in the equipment canister on the ocean floor. Power from the generator is carried to shore through an armored and shielded undersea cable on the ocean floor. The undersea cable would be connected to a land transmission cable in a concrete utility vault located above the high water mark. From the vault the power would be carried through a land transmission cable to a shore based facility where it would be converted into power that can be distributed to the MCBH Kaneohe Bay electrical power grid.

Following the five-year testing phase, the buoys and transmission cables would be removed from the test site.

1.3 Project Location

The test site is located on the sea floor approximately 4,000 feet (1,219.2 meters) northeast of the end of the main runway at MCBH Kaneohe Bay in approximately 100

feet (30.5 meters) of water.¹ The site offers a combination of favorable ocean wave climate, ocean floor topography, restricted public access, and onshore utility infrastructure needed for conducting the WEC system test.

1.4 Scope

The scope of work included:

1. Observing ocean recreation activities and ocean conditions at MCBH Kaneohe Bay.
2. Interviewing resident and military shore and ocean users, including lifeguards and fire fighters who provide emergency rescue services.
3. Identifying potential impacts of the buoys and the undersea cable on ocean activities and on shore and ocean users.

1.5 Survey Methodology

Information for this report was gathered from site visits and from interviews with people familiar with the shore and offshore waters of MCBH Kaneohe Bay. Site visits and interviews were conducted during April 2002 and May 2002.

2 PHYSICAL CONDITIONS

2.1 Survey Area

MCBH Kaneohe Bay occupies Mokapu Peninsula, the large peninsula at the south end of Kane'ohe Bay. The survey area for this report is the shore of MCBH Kaneohe Bay that includes North Beach, the seaward edge of the MCBH Kaneohe Bay main runway, Pyramid Rock Beach, and the waters approximately 1 mile (1,609 meters) off this shore.

North Beach and Pyramid Rock Beach are long, calcareous sand beaches that are located on either side of the main runway. The backshores of both beaches are lined with vegetated sand dunes. Surfing sites are found along the entire length of the survey area, including off the main runway, and are especially good during the winter surf season. High surf on O'ahu's North Shore usually generates high surf in the survey area. High surf in the survey area is also generated by swells from the east or northeast, but these swells are less frequent.

The foreshore on North Beach has several small rocky points, outcroppings of basalt that are attractive shore fishing sites. A small reef off the west end of North Beach is both a surfing and a spear fishing site. It is known either as Boulders for a cluster of large boulders on the ocean bottom or as Generals for its location off the home of the Commanding General.

Both North Beach and Pyramid Rock Beach and all of the surfing and fishing sites fronting them lie within a prohibited zone known as the Naval Defense Sea Area 500-yard (457.2 meters) Buffer Zone. The prohibited zone includes the waters 500 yards (457.2 meters) off the shore of the survey area.

¹ One alternative considered as the test site for this project is MCBH. This report analyzes the proposed action, North Beach, MCBH Kaneohe Bay.

The ocean floor between the beach and the proposed buoy cluster is primarily flat limestone without any remarkable relief.

2.2 Base Regulations

The following information regarding the survey area is summarized from MCBH Base Regulations, Chapter 11 Recreational Activities.

2.2.1 Buffer Zone

Kane'ohe Bay is an established Naval Defense Sea Area (NDSA) by Executive Order. However, the Chief of Naval Operations has suspended control except for a 500-yard (457.2-meter) buffer zone extending seaward from the shoreline of MCBH Kaneohe Bay, subject to reinstatement of control over the entire area by him or his representative without prior notice. Only active duty military personnel and MCBH civilian employees may enter the NDSA/500-yard (457.2-meter) buffer zone. All others must seek authorization from the Commanding General who is the entry control commander for the NDSA around MCBH Kaneohe Bay.

2.2.2 Lifeguards

Weather permitting, MCBH Kaneohe Bay lifeguards are normally on duty at North Beach and Pyramid Rock Beach from 1100 to 1730 year-round. Lifeguards have the authority to enforce laws and regulations pertaining to beach safety and patronage by authorized persons.

2.2.3 Boating

Boats within the NDSA/500-yard (457.2-meter) Buffer Zone are subject to inspection by military police, MCBH game wardens, U.S. Coast Guard (USCG) or Waterfront Operations harbor patrol at any time without notice. Commercial fishing in the NSDA is unauthorized unless approved by the Commander, Naval Base Pearl Harbor, Hawai'i. Only active duty military personnel and MCBH civilian employees may boat in the 500-yard (457.2-meter) buffer zone. All others must receive approval from the Commanding General.

2.2.4 Permitted Areas

Permitted areas for ocean recreation activities are at North Beach from 300 feet (91.4 meters) east of Runway 4-22 (main runway) extending east to 300 feet (91.4 meters) east of Pond Road and at Pyramid Rock Beach from 300 feet (91.4 meters) west of Runway 4-22 (main runway) along the shore to the Pyramid Rock security fence.

2.2.5 Variances

Commercial fishermen and other persons and organizations desiring entry into the 500-yard (457.2-meter) buffer zone or wanting variance from these regulations must apply in writing to the Commanding General.

2.2.6 Penalties

Violation of the regulations governing boating, diving, swimming, body boarding, and surfing may result in the denial of the privilege to use MCBH Kaneohe Bay beaches and waters as well as other administrative or disciplinary action under the UCMJ and state/county law. MCBH will prosecute civilians violating the NDSA, who are trespassing, to the fullest extent of the law.

3 OCEAN ACTIVITIES

The shore of the survey area is a popular ocean activities area. Most of the activities are concentrated near the lifeguard towers on North Beach and Pyramid Rock Beach. The shore for 300 feet (91.4 meters) on either side of the main runway is off limits.

Within the NDSA/500-yard Buffer Zone activities are limited to military personnel and MCBH civilian employees. In the event that an unauthorized entry occurs in the buffer zone, lifeguards address the entry themselves if it occurs on or near shore. If it occurs offshore, especially if it involves a civilian boat, they call Waterfront Operations to assist them with a boat.

3.1 Specific Activities within the NDSA/500-yard Buffer Zone

Specific activities within the NDSA/500-yard (457.2-meter) Buffer Zone in the survey include beachcombing, bodyboarding, bodysurfing, surfing, swimming, sunbathing, pole fishing, thrownet fishing, spear fishing, and scuba diving. According to Base Regulations these activities are prohibited within 300 feet (91.4-meters) of either side of the main runway. The undersea cable is proposed to come ashore at the west end of North Beach immediately adjacent to the runway, placing it within the prohibited 300-foot (91.4-meter) zone. Therefore, by regulation no contact should occur between beach and ocean users and the undersea cable.

The prohibited 300-foot (91.4-meter) zone on either side of the runway is not marked or signed, however, leaving its boundaries to the judgment of the beach and ocean users. At present this situation contributes to beachcombers, fishers, and surfers periodically entering the zone where they may contact the undersea cable where it comes ashore. In addition, during periods of high surf, powerful longshore currents, especially at Pyramid Rock Beach, occasionally sweep swimmers and surfers into the 300-foot (91.4-meter) zone and off the rock revetment lining the main runway before lifeguards can reach them. It may, therefore, be possible that swimmers or surfers caught in the currents on either side of the runway may unintentionally contact the undersea cable.

3.2 Specific Activities Outside the NDSA/500-yard Buffer Zone

The Mokapu Peninsula is a wide headland that separates Kailua Bay and Kane'ohe Bay, two of the largest ocean recreation sites on windward O'ahu. Both bays have public boat ramps for trailered boats. Kane'ohe Bay has a public small boat harbor at He'eia Kea, two private marinas, the Kane'ohe Yacht Club (KYC) with 190 slips and the Makani Kai Marina with 80 slips, and other private piers and slips on the shore of the bay. The waters of the survey area outside the NDSA/500-yard (457.2-meter) Buffer Zone are a primary transit corridor for boats traveling between the two bays and for boats heading for

Kane'ohe Bay from other parts of O'ahu, the neighbor islands, and the mainland. Specific activities outside of the NDSA/500-yard (457.2-meter) Buffer Zone in the survey area include boating, bottom fishing, jet skiing, kayaking, outrigger canoe paddling, scuba diving, spear fishing, sailing, and trolling.

3.2.1 Boating

The waters in the survey area off the NDSA/500-yard (457.2-meter) Buffer Zone are a well-used boating corridor for all types and sizes of boats, including jet skis, kayaks, and canoes. Many of them travel through "The Slot", the channel between Mokumanu and Ulupa'u Crater. Boats heading east from Kane'ohe Bay to Kailua and beyond often travel from Sampan Channel through The Slot and return the same way. During periods of high surf, waves breaking on the undersea ledges adjacent to Mokumanu may deter some boaters from this course and force them outside of Mokumanu, but in general The Slot is a shorter, faster, and, therefore, preferred route to and from Sampan Channel.

Recreational scuba diving and some commercial scuba diving tours occur at Mokumanu, a 16.6-acre (6.7-hectare) island off Ulupa'u Crater that is part of the Hawai'i State Seabird Sanctuary. As part of the sanctuary, landing on the island is prohibited, but the waters surrounding Mokumanu are a popular dive site. The island is noted for a sea cave on its north side and for tiger sharks. Dive boats usually come from Kane'ohe Bay and transit the survey area to reach the island.

Sailboats frequently transit the waters of the survey area. In addition, KYC holds four annual club races through the survey area for their racing fleet. These races draw from five to 20 participants. One of their popular races courses is from R2, the head buoy at Sampan Channel, through the survey area to a mark on the north side of Mokumanu, and back to Sampan Channel. KYC also sponsors the Kalakaua Cup, an annual race from Waikiki to Kane'ohe and back that transits the survey area, the sailboats coming through The Slot to reach Sampan Channel. The two-day race includes a return leg over the same route on the second day. Every even year in July, KYC hosts the Pacific Cup, a sailing race from California to Hawai'i, that ends at Kane'ohe with 70 boats racing for the finish line at the entrance to Sampan Channel. The boats normally keep Mokumanu to port, especially at night, and pass outside of the island, but may still transit the survey area as they head for Sampan Channel. During the day some of these boats may race through The Slot to reach the finish line.

Non-motorized boats such as outrigger canoes (six-person and one-person), surf skis (racing kayaks), and ocean kayaks (recreational kayaks) traverse the survey area, normally for recreation or training and occasionally for racing. At least one annual kayak race passes through the area. The Kailua to Kualoa Race, an 11-mile (26.7-kilometer) event, sponsored by Kanaka Ikaika, a kayak and one-person outrigger canoe racing organization, is held in February. The race course passes starts at Kailua boat ramp, passes through The Slot, through the survey area, and ends at Kualoa Regional Park at the north end of Kane'ohe Bay. Approximately 200 individual paddlers and four escort boats participate in this event. The Kane'ohe Canoe Club, a six-person canoe racing club, is based in Kane'ohe Bay and occasionally transits the survey area on their training runs.

3.2.2 Fishing

Trolling and bottom fishing are the two most popular types of fishing in the survey area. The 100-foot (30.5-meter) contour line is a popular trolling site because of a ledge at that depth. Ono are attracted to the ledge and it is popularly known as the Ono Run. In addition to boats fishing on the Ono Run, boats departing and returning to Kane'ohē Bay make it a point to pass through the site if they are trolling. Humpback whales and aku, or skipjack tuna, are also reported to frequent the same area. Some bottom fishing occurs for uku, a gray snapper, moano kali, a goat fish, and other similar bottom species. The survey area is not considered an especially productive site for spear fishing but spear fishers pass through the area on their way to other sites such as Mokumanu.

Scientists from the University of Hawaii's Hawaii Institute of Marine Biology (HIMB) at Coconut Island in Kane'ohē Bay fish in the survey area for sharks, primarily for sandbar sharks. The sharks are hooked and kept as live specimens at Coconut Island for HIMB research projects.

4 MARINE PUBLIC SAFETY AND RECREATIONAL USES ISSUES

During April and May 2002, interviews were conducted with individuals who are familiar with the survey area and who represent various user groups in the survey area. Those individuals are as follows:

- Jeff Barbieto, Lifeguard, MCBH
- Kevin Browne, windward sailor and spear fisher
- Terry Cano, Rescue Captain, Honolulu Fire Department
- Elani Ching, Captain of the Aikane, Kane'ohē Bay Ocean Sports
- Jon Emerson, president of Kanaka Ikaika
- Ron Johnson, windward boater and fisher
- Gerard Kalani, Senior Chief and head of Waterfront Operations, MCBH
- Randall Kunichika, Harbormaster He'eia Kea Small Boat Harbor
- Robert Leary, sailor, KYC member
- Andy Lopez, sailor, sailor, KYC member
- George Losey, staff member Hawaii'i Institute of Marine Biology, KYC member
- Sam Mensch, Lifeguard, MCBH
- Earl Nishikawa, Chevron Hawai'i Fire Chief
- Rocky Owens, Lifeguard, MCBH
- Tom Pochereva, Regatta Chairman, KYC
- Robert Rocheleau, Ocean engineer, Sea Engineering Inc.
- Clyde Sasaki, Kane'ohē Bay Invitational Skin Diving Tournament Director
- Rob Smith, Aaron's Dive Shops
- Harry Sprague, Lifeguard, MCBH

- Daryl Wong, blue water diver and spear gun manufacturer
- Aaron Young, Rescue Captain, Honolulu Fire Department

Interviews were also conducted with Peter Latham, Tesoro Mooring Master, and Kurt Jacobson, Chevron Mooring Master, in regard to marine public safety and recreational uses issues at the Chevron mooring buoy site off Campbell Industrial Park.

4.1 Public Safety Overview

The WEC test will include six large buoys located approximately 4,000 feet (1,219.2 meters) off the MCBH Kaneohe Bay main runway anchored in approximately 100 feet (30.5 meters) of water and an undersea cable that will connect the buoys to a junction vault on shore. If it were possible to impose security on the entire marine portion of the test system and prevent public interaction with the buoys and the undersea cable, then public safety would not be a significant issue. However, only 37.5 percent of the system falls within waters that are defined by the NDSA/500-yard (457.2-meter) Buffer Zone, the prohibited zone that is controlled by the military. The remaining 62.5 percent of the system lies offshore in waters that are used and transited by a wide variety of public boating traffic, and the buoy cluster will lie within the single most heavily trafficked corridor in the survey area.

At present security in the NDSA/500-yard (457.2-meter) Buffer Zone is enforced by the lifeguards, the security personnel from Waterfront Operations, and other security personnel from the base. The lifeguards handle security violations on the beach and within the surf zone and call Waterfront Operations for a boat with security personnel for boating violations between the surf zone and the outer limit of the NDSA/500-yard (457.2-meter) Buffer Zone. Other security personnel on base are called as necessary. There is no security enforcement beyond the NDSA/500-yard (457.2-meter) Buffer Zone.

Preliminary suggestions for security on the buoy cluster include equipping each buoy with a navigational aid such as a yellow flashing light on an above-water extension from each buoy and monitoring the system daily and nightly with a visual check through shore binoculars. Additional suggestions have included designating the buoy cluster as a restricted area and advising boaters with a Legal Notice to Mariners (LNM), issuing chart corrections showing the buoys, placing signage on the buoys alerting boaters that they should not be there, and installing cameras on the buoys that would be able to pan 180 degrees and photograph boaters entering the restricted area.

It is the opinion of all the informants, however, that even if all of these security measures are implemented, boaters, especially fishers, will disregard them and still enter the restricted area. The informants believe that the buoys will act as fish aggregating devices, or FADs, and that the prospect of productive fishing will outweigh the prospect of the consequences of entering a restricted area, especially a restricted area that has no enforcement component.

The State of Hawaii's Division of Aquatic Resources in the Department of Land and Natural Resources has installed and maintains approximately 50 FADs around the main Hawaiian Islands. The FADs are large surface buoys that are anchored in waters up to 1,000 fathoms, and as their name implies, they attract pelagic species, making them

popular fishing sites for boaters. While the WEC buoys will be anchored at approximately 100 feet (30.5 meters), no where near the depths of the State's FADs, they will still act as FADs and probably attract a variety of fish, including some popular pelagic species such as ono, mahimahi, and 'opelu. In addition, the anchoring systems holding the buoys to the sea floor may also act as FADs and attract shallow water species.

The buoys, then, will attract fishers in boats, such as trollers and bottom fishers, and divers in boats, including spear fishers and blue water divers. Trollers will motor near the buoys as they do the FADs and bottom fishers will either drift near the buoys, anchor near them, or tie off on them. The anchoring depth of the buoys at approximately 100 feet (30.5 meters) is a diveable depth for most experienced scuba divers, especially commercial divers. They will dive primarily to spear the shallow water species around the anchoring systems, but may also use underwater surround nets and traps. Blue water divers are a unique subset of spear fishers who use high-powered spear guns at the State's FADs. They float in the water near the FADs and try to spear large pelagic game fish such as a'u (marlin), 'ahi (yellowfin tuna), and mahimahi (dolphin) that are attracted to the FADs. Blue water divers will also be attracted to the WEC buoys.

The buoy cluster will be of interest to recreational scuba divers who will regard them as a unique dive site such as a cave dive or a wreck dive. They will want to dive on them just to see the buoys and observe them in action. Some divers may be inclined to vandalize the system components, while others may attempt to steal the undersea cable to salvage its copper wiring.

4.2 Public Safety Concerns

In summary, the buoy cluster will attract a lot of attention from the entire community of boaters and fishers that presently use the area and will probably attract additional boaters and fishers to the area that do not use the area now. The public safety concerns assume that boaters and fishers will use and transit the restricted area either intentionally or unintentionally and that there may be interaction between people and the buoys or interaction between boats and the buoys. The public safety concerns are described in the following paragraphs.

4.2.1 Depth of the Buoys

Present estimates of the depth of the water between the top of the buoys and the surface of the ocean range from a low of three feet to a high of 13 feet (4 meters). Every informant stated that the lower depths are too low and at some point will result at minimum in damage to propellers, hulls, or keels and at maximum in the sinking of a boat. The propellers of some motor boats penetrate deeper than three feet below the surface and the keels of the sailing boats at KYC range in length from four to nine feet in length. Many of the informants mentioned that high surf or rough seas in the survey area result in deep troughs between ocean swells which will further reduce the depth of water over the tops of the buoys. Some also mentioned that tidal variations need to be considered during the installation of the buoys, that they should be installed to consider the lowest of Hawai'i's low tides, the low tides that occur in April and May. One boater

stated that even if the buoys are marked and lighted, he would give them a wide berth at night even if it added to his travel time to ensure that he would not run into them.

4.2.2 Entanglement

Entanglement may take several forms. First, the buoys move up and down a rigid central spar buoy like a piston. Is it possible that a diver's equipment or body part, an arm or leg, could be caught between the buoy and the central spar buoy? Second, is it possible that fishing lures and anchor lines, items that fishers or boaters might try to free or retrieve, could be caught between the buoy and the central spar buoy? Third, is it possible that divers might become entangled in the buoy anchor systems? Fourth, are the speed and travel distance of the buoys during their piston-like movements powerful enough to strike and injure a diver directly above or below them? Fifth, the undersea cable that runs approximately 4,000 feet to shore is an armored and shielded cable. Can its integrity be compromised by an anchor striking it, an anchor snagging and pulling on it, or by someone trying to cut it?

4.2.3 Hazard to Navigation

The anchor system proposed to hold the buoys to the sea floor is rated with a very low probability of failure, but in a worst-case scenario, a buoy may break free and become a hazard to navigation. Automated Global Positioning Systems (GPS) on board the buoys continuously monitor their location and send out messages to the appropriate authorities if a buoy is sensed to be outside its watch circle; but when the appropriate authorities receive this information, what is the emergency operations plan that would notify mariners and initiate recovery and what is the lapsed time to notification and recovery? Loose buoys would probably drift into the MCBH Kane'ohe Bay beaches or into Kane'ohe Bay.

4.2.4 Other Concerns

Other public safety concerns identified by the informants are as follows:

1. Boaters attempting to fish or dive on the buoys may tie up to the navigation aids marking the buoys, damaging or breaking them off completely.
2. Bottom fishers may drift in the area, anchor, or tie up at night as well as during the day.
3. The buoys will be located off two popular swimming and surfing sites. If they do act as FADs, the smaller fish will attract larger predatory fish, including sharks. The buoys may increase the shark population near the beaches.
4. Will the electricity that is generated and transmitted have any impact on marine species?
5. Will the undersea cable disrupt the sand movement along North Beach?

4.2.5 Miscellaneous Comments

Miscellaneous comments made by the informants are as follows:

1. Many whales transit the area and many turtles frequent the area. Hopefully, the WEC system will not disturb them.

2. If the buoys were moved closer to shore, even into the prohibited area, it would eliminate many, if not all of the public safety concerns. But it is understandable why they are being placed at 100 feet (30.5 meters). Boaters can see the change in depth there and the increase in swell heights as waves move from deeper to shallower water.
3. The idea of using wave energy to generate electricity is good. It makes good environmental sense.
4. Boaters are not supposed to tie up to the State's FADs, but they do anyway.

4.3 Chevron Mooring Site Off Campbell Industrial Park

Chevron Hawaii Inc. has a mooring site in approximately 100 feet (30.5 meters) of water off Campbell Industrial Park. The site is used to discharge petroleum products from tankers moored offshore to the Chevron and Tesoro refineries in the industrial park. Interviews were conducted with Peter Latham and Kurt Jacobson, the mooring masters for Tesoro and Chevron respectively, in regard to marine public safety and recreational uses issues at the Chevron mooring buoy site.

4.3.1 Peter Latham

Tesoro Petroleum Corporation has a single point mooring buoy at the Chevron mooring site. It is 36 feet (11 meters) in diameter, 12 feet (3.7 meters) deep, and is anchored at approximately 110 feet (33.5 meters). The site is a restricted zone for 1,500 yards (1,371.6 meters) around the mooring buoys, but the public ignores it. Some fishers believe they have native Hawaiian fishing rights to fish anywhere they want to.

Their mooring buoy in particular acts as a FAD and is visited regularly by fishers in boats. Vandalism has occurred when people have boarded the buoy and tampered with the valves. The buoys and the associated equipment and hoses are vulnerable when no one is at the site, and repairs are expensive. When product is being discharged, it goes through floating hoses to the buoy and then to a submarine pipeline to the beach. Longline fishing boats on autopilot have come straight through the mooring site and hit their hoses.

Tesoro has installed an infrared digital camera with a high speed digital recorder on top of one of its tanks at the refinery. The tank is 50 feet (15.2 meters) high and the camera is focused on the mooring buoy. The images that are transmitted to their control center are monitored on a 13-inch (33-centimeter) television screen. If a boating violation in the restricted zone is observed, the control center notifies the USCG and they dispatch a vessel to the scene.

Tesoro purchased the security camera system from B.E. Meyers & Company Inc. in Redmond, Washington. Chris Tott was the engineer who installed it. The total cost was approximately \$100,000.

The buoys clustered off the marine base will probably act as FADs, and if they do, the fishers will come. The area needs to be restricted if people are to be kept out, and an immediate response to security violations needs to be a part of the security program, along with an onshore camera system like theirs.

4.3.2 Kurt Jacobson

Tesoro has one big buoy, over 30 feet (9.1 meters) in diameter. The buoy has plenty of fish below it and attracts fishers. The size of the buoy allows people to climb on it and to use it as a scuba diving platform. This had led to the buoy and its components being vandalized, so Tesoro purchased a security camera to deter vandals and fishers.

Chevron has seven anchoring buoys that are large cylinders eight feet in diameter and 15 feet (4.6 meters) long that lie on their side. These buoys and their anchoring systems do not attract fish, offering few places for smaller fish to hide. The buoys cannot be boarded. Their mooring site is restricted, off limits on the charts, and marked by four spar buoys on its perimeter, two of which are lighted. The mooring buoys are not lighted, but are covered with reflective tape.

The site off MCBH Kaneohe Bay would have to be designated as a restricted area to protect boaters and the buoys and as a no anchor zone to protect the undersea cable. The corners of the restricted area should be marked with perimeter buoys.

5 IMPACTS ON OCEAN ACTIVITIES

The impact of the WEC system on ocean activities in the survey area within the NDSA/500-yard (457.2-meter) Buffer Zone will be insignificant. The zone is well-regulated, the regulations are known to all residents and employees on MCBH Kane'ohe Bay and to the general public, and the regulations are enforced by lifeguards, security personnel from Waterfront Operations, and security personnel on base. The site where the undersea cable will come ashore and cross the beach is within the 300-foot (91.4-meter) restricted zone adjacent to the main runway, a zone that is controlled by flight operations and that is already off limits to all beach and ocean users. The undersea cable is armored and shielded and will be protected by a split pipe where it is exposed on the beach between the ocean floor and the junction vault in the backshore. In the event that a beach or ocean user unintentionally enters the restricted zone and contacts the cable either in or out of the water, there should be no safety concerns.

The impact of the WEC system in the survey area on ocean activities beyond the NDSA/500-yard (457.2-meter) Buffer Zone will be minimal if public access to the site is restricted, marked, and respected. The buoy cluster will lie in a primary transit corridor for boaters, the waters inshore of Mokumanu and the entrance to Sampan Channel in Kane'ohe Bay. If boaters respect the restricted area and observe the navigational aids marking the site, then the impact to them will only be having to detour around the restricted area by going either inside or outside of it.

Even under the assumption that boaters will respect the restricted area and avoid it, there is still a danger to them if the tops of the buoys are near enough the surface of the ocean to strike a hull, propeller, or keel. For any number of reasons, including foul weather, poor visibility, vandalized navigational aids, and mechanical problems, boaters may unintentionally transit the restricted area and interact with the buoys. The depth of the water between the surface of the ocean and the tops of the buoys needs to be evaluated for worst-case scenarios.

It is the opinion of all the informants that the buoys will to some degree act as fish aggregating devices, or FADs, and will, therefore, attract fishers, including scuba divers, to the site. In the event that this occurs, the public safety concerns that are identified in the previous section may also occur. If a worst-case public safety scenario occurs, a boat may be sunk and its crew endangered or a diver may be endangered. Although remote, the potential for serious impacts on ocean users is possible.

5.1.1 Long Term Impacts

One fisher noted that the project may be a double-edged sword. He thinks the effort to develop alternate energy is good, but he noted that if the project is successful and the U.S. Navy decides to develop a permanent WEC site, then probably more sites will follow. If additional sites are restricted to areas controlled by the military, more sites would probably not be a problem, but if WEC sites are developed in civilian areas as well, they may have an impact on fishing. If each WEC site is designated as a restricted area, then commercial and recreational fishers in Hawai'i will lose more fishing areas in addition to those that are now designated as marine life conservation districts (MLCDs).

Additional restricted areas will require more buoys and navigational aids to be placed in the ocean. Normally, buoys and navigational aids are located at or near harbors and boat ramps, but this is not the case for WEC sites which have other criteria for determining sites. This means that buoys and navigational aids may begin appearing in areas all around the islands and impact view planes that are now open to the horizon.

Appendix J

Wave Energy Conversion (WEC) Buoy Impact
on a Wave Field. May 2002.
Sea Engineering Inc.

WAVE ENERGY CONVERSION (WEC) BUOY IMPACT ON A WAVE FIELD
Prepared by Sea Engineering, Inc.
May 2002

WAVE ENERGY CONVERSION (WEC)
BUOY IMPACT
ON A
WAVE FIELD

May 2002

Prepared for:
Belt Collins Hawai'i
2153 North King Street, Suite 200
Honolulu, Hawaii 96819

Submitted by:
Sea Engineering, Inc.
Makai Research Pier
Waimānalo, Hawai'i 96795

Background

A Scripps Institution of Oceanography wave buoy located 4.5 miles southeast of Mokapu Point, Oahu has been measuring waves since August 9, 2000. The buoy position is at 21°24.9' north and 157°40.7' west in a water depth of 100 meters. This buoy provides wave data directly applicable to the project site, since the wave exposure is the same. A summary of the wave data for a period of 20 months, August 2000 to March 2002, is presented in Table 1.

As shown in the table, 74 percent of waves approached the buoy from a directional range between 030 and 090 degrees. Eighty-five percent of waves were between 1.2 and 2.4 meters in height, and 83 percent of waves had wave periods between 6 and 12 seconds. Waves with a period greater than 12 seconds occurred 10 percent of the time. Although not shown in the table, a review of the buoy data indicated that most of the long period waves (14 seconds or greater) came from northerly directions.

The WEC buoys for the MCBH installation¹ will be cylindrical buoys with a 4.5-meter diameter and a 20-meter height. The buoys will be anchored in approximately 30 meters of water with their tops about 1 meter below the ocean surface. The program is a demonstration program and at least two and possibly up to six buoys may be installed for a five-year period. The analysis was conducted for the maximum number of buoys (six). The alignment analyzed for wave interference is shown in Figure 1. The buoys are aligned approximately parallel to the 30-meter depth contour line and spaced approximately 45 meters apart.

There are two possible mechanisms by which the buoys could reduce wave heights; by wave scattering, and by energy absorption by the buoys. Both mechanisms were considered in this analysis.

Two representative deepwater waves, based on the Mokapu buoy statistics, were selected for the analysis. The first was a wave with a 9-second period approaching from 050 degrees True. The second was a 15-second wave, approaching from True North. The assumed deepwater wave height was 2 meters for each wave type.

Wave Height Reduction due to Wave Scattering

Our analysis of wave height reduction due to scattering was based on a numerical solution developed by Dalrymple et al. (1988) to evaluate wave scattering caused by wave passage through an infinite grating of circular cylinders. Their report presented the wave scattering effects in terms of wave reflection and transmission coefficients. The report included a graphical presentation of the numerical results for two cases, reproduced here as Figures 2 and 3. The definitions of the variables in the figures are:

¹ One alternative considered as the test site for this project is North Beach, MCBH Kaneohe Bay. This report analyzes the proposed action - North Beach, MCBH Kaneohe Bay.

a = a cylinder radius (for our case, 2.25 m)
 k = wave number ($= 2\pi/L$, where L is the wave length)
 d = cylinder spacing (for our case, 45 m)
 K_T = transmission coefficient
 K_R = reflection coefficient.

Figure 2 shows Dalrymple's plotted results for $ka = 0.1$, which for our buoy radius of 2.25 m, corresponds to a 10.2 second wave. The two dotted lines at the top of the figure show the wave transmission coefficient for two angles of approach, one perpendicular to the row of cylinders and the other 30 degrees off perpendicular. The solid line shows the reflection coefficient for the two approach angles. The figure indicates that wave approach angle, for the variation shown, makes little difference in the transmission coefficient and no difference in the reflection coefficient.

Figure 3 presents Dalrymple's results for a larger ka value, which for our buoy radius corresponds to a 4 second wave period. As for the longer period wave, the 30 degree variation in wave approach makes little difference.

Reflection and transmission coefficients are determined by entering the graphs with a $2a/d$ value for our case of 0.1. For both cases the reduction in wave transmission is so small as to be indeterminable, and the wave reflection is also negligible. This is due to the relatively large spacing between cylinders as compared to the buoy diameter.

Wave Height Reduction Due to Energy Absorption

The WEC buoys will absorb some of the incident wave energy, and will convert this energy into electrical power. In personal communications, Ocean Power Technology, Inc. indicated that a maximum wave energy absorption efficiency for wave buoys was estimated to be 50 percent, and that a realistic prediction of the average efficiency for the proposed wave-power buoys was 20 percent. Using these efficiency values and an approximate width of the area in which the waves would be reduced (shadow zone) allowed an assessment of the wave height reduction due to energy absorption by the WEC buoys.

The width of the "shadow zone" for the six buoy array was estimated for various distances inshore of the array by running a wave refraction-diffraction model (*REF/DIF 1*, developed by J. T. Kierby and R. A. Dalrymple) using six submerged piles extending upward from the seafloor to represent the WEC buoys. The grid point interval used for the model runs was 5 meters, the approximate diameter of one pile. The top of each pile was one meter below the ocean surface. The computer model was run for the same two wave conditions used for the wave scattering analysis. Each wave condition was run twice, once with the piles in place, and once without the piles.

The "shadow zone" widths were determined by comparing the model results for the wave refraction and diffraction with and without the piles. Areas affected by wave height changes were assumed to be within the "shadow zones". The "shadow zone" widths were determined along profiles parallel to the shoreline, at intervals of 200-meters inshore of the pile array. The results are given in Table 2.

The wave energy reduction immediately inshore of the array is 50-percent directly behind the buoy, but there is no reduction in the 45 m spacing between buoys. This is an average energy

loss for the 50 m wide area of 5-percent. Since the wave height is proportional to the square root of the wave energy, the average wave height reduction corresponding to this 5-percent energy loss is approximately 3-percent. Other wave height reduction factors farther inshore were determined from the plotted results of the *REF/DIF 1* program.

The shadow zone typically increases inshore of the buoy array due to wave diffraction effects, but as the width of the zone increases, the impact on the wave height decreases.

Using the affected area-width sizes, we estimated the wave height reduction from the following relationship:

$$E_1 S_1 = E_2 S_2$$

Where,

E_1 = wave energy absorbed at the buoy location

E_2 = wave energy reduction at a distance from the buoy location

S_1 = width affected on waves at the buoy location (a sum of all buoy widths)

S_2 = width of the affected area at a distance from the buoy location.

Table 2 shows the predicted wave height reductions for various distances inshore of the buoy array. At a distance of 800 m inshore of the array, the wave height reduction for a 9 second wave is predicted to be 1.2 percent, and less than 1 percent for a 15 second wave.

The wave height reductions in Table 2 were estimated for a possible maximum WEC buoy efficiency of 50 percent. Using a more realistic average efficiency of 20 percent, the wave height reductions near the shoreline would be 0.5 percent for a wave period of 9 seconds and less than 0.3 percent for a period of 15 seconds.

The results of this study indicate that the impact of six WEC buoys on a wave field will be minimal, and will not be noticeable or quantifiable given the randomness of the waves on any given day. There should be no impact on breaking waves or on littoral processes inside the surf zone.

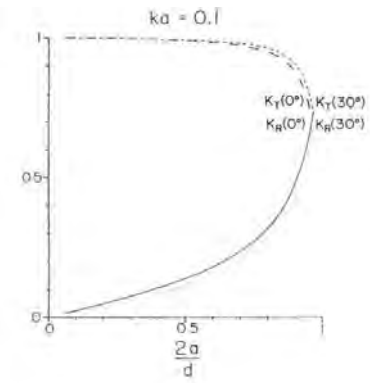
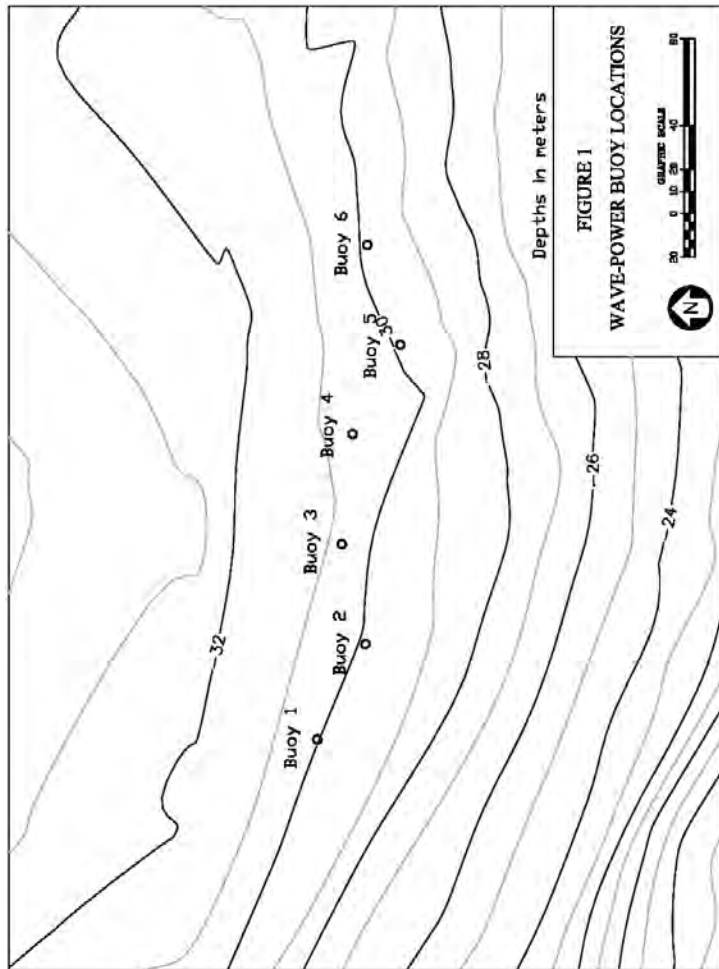

FIGURE 2. COEFFICIENTS OF REFLECTION AND TRANSMISSION FOR WAVE SCATTERING BY A ROW OF CIRCULAR CYLIDERS ($KA = 0.1$)
(From R.A. Dalrymple et al.,1988)

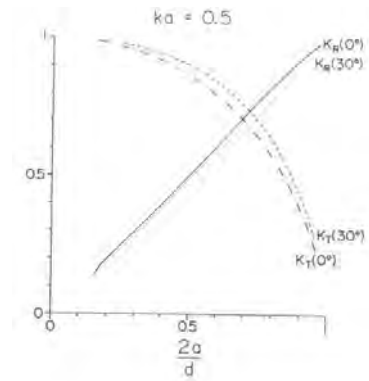

FIGURE 3. COEFFICIENTS OF REFLECTION AND TRANSMISSION FOR WAVE SCATTERING BY A ROW OF CIRCULAR CYLIDERS ($KA = 0.5$)
(From R.A. Dalrymple et al.,1988)

Table 1. Wave Statistics From Mokapu Buoy (Aug/2000–March/2002)

Wave Direction		Wave Height		Wave Period	
Direction (degrees)	Frequency (%)	Height (meters)	Frequency (%)	Period (seconds)	Frequency (%)
330-350	3.2	0-0.6	0.0	0-4	0.0
350-010	11.0	0.6-0.9	0.1	4-6	6.8
010-030	6.5	0.9-1.2	8.4	6-8	27.5
030-050	9.3	1.2-1.5	29.3	8-10	40.6
050-070	25.0	1.5-1.8	26.9	10-12	14.9
070-090	39.3	1.8-2.1	17.9	12-14	4.9
090-110	5.6	2.1-2.4	10.4	14-16	3.5
		2.4-2.7	4.4	16-18	0.9
		2.7-3.0	2.1	18-20	0.6
		3.0-3.3	0.3	20-22	0.1
		3.3-4.8	0.4	22-24	0.01
Range		Range		Range	
330 – 110 (clockwise)		0.7 – 6.5		4.0 – 22.2	

Table 2. Widths of Shadow Zones and Wave Height Reductions

Distance from Buoy Location (m)	Deepwater Wave Conditions			
	Period = 9 sec. Direction = 050 deg.		Period = 15 sec. Direction = 000 deg.	
	Affected Area-Width (m)	Wave Height Reduction (%)	Affected Area-Width (m)	Wave Height Reduction (%)
0	250	2.9	250	2.9
200	570	1.3	760	1.0
400	470	1.6	930	0.8
600	610	1.2	>1000	<0.8
800	640	1.2	>1000	<0.8

References

- Dalrymple, R. A., S. N. Seo, and P. A. Martin, 1988. *Water Wave Scattering by Rows of Circular Cylinders*, Pro. 21st Intl. Conference on Coastal Engineering, ASCE, Torremolinos.
- Kirby, J.T. and R. A. Dalrymple, 1994. *Combined Refraction/Diffraction Model, ref/dif 1, Version 2.5, Documentation and User's Manual*, Center for Applied Coastal Research, Dept of Civil Engineering, Univ. of Delaware.